

The Bionic Bra: Using electromaterials to sense and modify breast support to enhance active living

Julie R Steele¹ , Sheridan A Gho¹, Toni E Campbell², Christopher J Richards², Stephen Beirne², Geoffrey M Spinks² and Gordon G Wallace²

Abstract

Background: Although the most supportive sports bras can control breast motion and associated breast pain, they are frequently deemed uncomfortable to wear and, as a result, many women report exercise bra discomfort. Given that exercise bra discomfort is associated with decreased levels of physical activity, there is a pertinent need to develop innovative solutions to address this problem.

Objectives: This research aimed to evaluate the use of electromaterial sensors and artificial muscle technology to create a bra that was capable of detecting increases in breast motion and then responding with increased breast support to enhance active living.

Methods: The research involved two phases: (i) evaluating sensors suitable for monitoring and providing feedback on changes in the amplitude and frequency of breast motion, and (ii) evaluating an actuator capable of changing breast support provided by a bra during activity.

Results: When assessed in isolation, the developed technologies were capable of sensing breast motion and actuating to provide some additional breast support.

Conclusions: The challenge now lies in integrating both technologies into a functional sports bra prototype, and assessing this prototype in a controlled biomechanical analysis to provide a breast support solution that will enable women to enjoy active living in comfort.

Keywords

Breast support, sports bra, sensors/sensor applications, actuators, breast biomechanics, wearable devices

Date received: 27 February 2017; accepted: 18 April 2018

Introduction

The female breast contains limited anatomical support and, therefore, external assistance in the form of a bra is typically recommended to control breast motion.^{1,2} Although the principal purpose of a bra is to support the breasts, most bras designed for everyday wear represent a compromise between this supporting function, the need for comfort, and aesthetics to enhance a woman's breast shape. During tasks in which vertical movement of the upper body increases, such as in jogging or running, the demands on a bra with respect to providing breast support increase. For example, past research has found that vertical breast displacement can increase by more than 42 mm when a woman (bra size 14C; Australian bra sizing system) runs in an

everyday bra compared to walking in the same bra.³ As increases in vertical breast displacement as little as 20–30 mm have been repeatedly linked to breast pain

¹Biomechanics Research Laboratory, School of Medicine, Faculty of Science, Medicine & Health, University of Wollongong, Wollongong, Australia

²ARC Centre of Excellence in Electromaterials Science and Intelligent Polymer Research Institute, University of Wollongong, Wollongong, Australia

Corresponding author:

Julie R Steele, Biomechanics Research Laboratory, School of Medicine, Faculty of Science, Medicine & Health, University of Wollongong, Northfields Ave, Wollongong 2522, NSW, Australia.
Email: julie_steele@uow.edu.au



and discomfort, it is recommended that women wear a sports bra when exercising.³⁻⁶

Sports bras are designed to restrict vertical breast movement by encapsulating the breasts and/or compressing them against the chest wall. Sports bras achieve this function, in part, by using fabrics that are stiffer and allow less stretch than the fabrics used in everyday bras.⁷ In an evaluation of several sports bra styles, Lawson and Lorentzen⁴ reported that bras that were rated highly in terms of support were made from firm, low-stretch materials, whereas bras that used softer, highly elastic materials were poor at controlling breast motion. This research also highlighted that the physical characteristics of a sports bra that enables it to limit breast motion, such as firm, low-stretch materials, also tend to make the sports bra more uncomfortable to wear.⁴

A sporting activity or an exercise regime can include periods of activity when the additional support offered by a sports bra is desirable, in combination with periods of relative inactivity, when support is not as necessary. Ideally, in these situations a sports bra should relax during inactivity to improve wearer comfort. Similarly, an everyday bra might provide sufficient support during many activities of daily living or work, such as sitting relatively stationary at a desk, but situations can arise when additional breast support is unexpectedly required, such as having to run to catch a bus. These scenarios demonstrate that the potential exists for a bra design that can respond to the needs of the wearer by changing its physical characteristics to provide more support during higher levels of physical activity and then relaxing into a more comfortable state during periods of relative inactivity. Such a bra would require a 'sensor' that is responsive to a change in breast movement and an 'actuator' that can be triggered by the sensor and adjust the supportive elements in the bra.

Polypyrrole-coated textiles, in which a base fabric is coated with the conducting polymer, polypyrrole (PPy), have been found to be effective wearable strain gauges with a high linear dynamic range and gauge factors similar to conventional strain gauges.^{8,9} Textile-based sensors using this technology are relatively inexpensive to manufacture and can be applied to commercial high-stretch fabrics that conform to the body, making them ideal to incorporate into a wearable garment for bio-monitoring purposes.^{10,11} More specifically, our previous work indicated that a PPy-coated textile sensor, when pre-stretched by 20% of its initial length, was able to accurately and reliably monitor changes in the amplitude and frequency of vertical breast displacement when the sensor was attached appropriately to the wearer's bra.¹² Problems exist, however, when using these PPy fabric sensors. The textile sensor: (i) needs

to be pre-stretched to 20% before being placed on the bra because this is within the linear regime of the sensor response; (ii) displays recoil that produces a double peak in the sensor reading at the end of the stretch cycle/beginning of the unloading cycle; (iii) has a small response lag during measurements, thought to be caused by changes within the textile geometry, and (iv) the signal drifts over time with textile creep and exposure to the environment, making ongoing calibration of the sensor a necessity.¹²

In an attempt to alleviate the issues associated with PPy-coated textile sensors, we investigated the use of an encased polypyrrole mechanical bending sensor, composed of PPy layers either side of a polyvinylidene fluoride (PVDF) porous membrane filled with electrolyte,^{13,14} which could also potentially be used to monitor breast motion. In this arrangement, a bending displacement of these thin film sensors generates a small electrical potential difference in the millivolt range, providing a mechanoelectrical output. These structures are fully encapsulated in a flexible coating to increase device stability and improve immunity to the environment.¹⁵ Here we investigate the use of encapsulated bending sensors for their suitability to measure breast movement amplitude and frequency for the purpose of triggering an actuator in a responsive bra.

In addition to sensing a change in breast movement, the proposed responsive bra must also be capable of physically adapting in response to the sensor input to provide an appropriate level of breast support. Recent advances in artificial muscle research have produced 'Baughman muscles', which consist of thermally driven coils made from low cost polymer fibres, such as nylon fishing line and polyester sewing thread that are capable of contracting by up to 49%.¹⁶ Specifically, an actuating textile can be produced by weaving conventional polyester, cotton and silver-plated nylon yarn (to drive the electrothermal actuation) through a parallel assembly of Baughman muscles.¹⁶ We postulate that such an actuating textile, when positioned appropriately on a bra, has the capacity to modify breast support by changing bra tightness.

Incorporating the above-mentioned sensor and actuating technologies into a bra so it can respond to a wearer's needs and provide the appropriate level of support for women when they are active appears possible. Therefore, the aim of this research was to investigate the feasibility of integrating electromaterials into a bra to create a garment that can change its physical characteristics and alter the level of breast support in response to changes in breast motion. We call this system the 'Bionic Bra'. To achieve this aim, the research involved two phases: (i) identifying a sensor suitable for monitoring and providing feedback on changes in the amplitude and frequency of breast

motion, and (ii) identifying an actuator capable of changing breast support provided by a bra during activity. It was hypothesised that: (i) sensors made from electro-materials would be able to detect changes in the amplitude and frequency of breast motion during activity, and that (ii) actuators made from electrothermally driven Baughman artificial muscles could contract to tighten the bra sufficiently to increase breast support.

Experimental methods

Fabrication of the bending sensors

Polypyrrole (PPy)-based tri-layer bending sensors were fabricated as described in detail previously.¹³ Briefly, a PVDF porous filter membrane (millipore of nominal 0.45 μm pore size, 75% porosity and $\sim 110 \mu\text{m}$ thickness) was sputter coated on both sides with platinum. Polypyrrole was deposited galvanostatically at a current density of 0.10 mA cm^{-2} for 12 h on the Pt surfaces from a polymerisation solution containing pyrrole monomer (0.06 M, Merck, freshly distilled) and tetrabutylammonium hexafluorophosphate (0.05 M, TBA.PF6, Aldrich) in propylene carbonate (99.7% anhydrous, Aldrich). Following electrodeposition, all edges of the as-prepared bulk membrane were trimmed off and then cut to small strips (20 mm \times 1 mm) using a scalpel blade, ensuring that the two PPy layers on opposite sides of the PVDF membrane were not in electrical contact. The sensor was then encapsulated between two pieces of adhesive tape cut to slightly larger than the sensor dimensions.

Sensor evaluation

For qualitative human testing, the sensor was encased in adhesive tape and attached to the inferior aspect of the cup of an everyday bra (Brand: Berlei, Style: Touched, Size: 14C), worn by a participant as she walked and jogged on a treadmill at 7 kph.

The mechanical bending sensor relies on deformation to generate a signal and is designed to deform principally in bending and twisting modes. For this reason, we positioned the sensor on the bra so that breast motion was most likely to apply a force to bend the sensor. The sensor was therefore attached to the inferior aspect of the bra cup because: (i) the sensor could detect a change in curvature of the bra cup rather than stretch; (ii) the sensor was fully conformed to the bra cup; (iii) breast tissue was always in contact with the bra material at the base of the bra cup thus ensuring a continuous signal, and (iv) a large increase in the amount of ‘downward’ breast motion was observed as the participant changed from a walk to a run.

Baughman muscle coiled fibre fabrication

Actuating fibres for this experiment were fabricated from 0.4 mm diameter monofilament nylon 6 fishing line. A length of fibre was attached vertically to a rotary tool whilst the other end was tethered to prevent rotation, but allowed to move vertically. A load of 300 g was also attached to the bottom end to apply tension and prevent unfavorable ‘snarling’ of the fibre (snarling occurs when the end is unrestrained and over-twists onto itself). Twisting was applied until coil propagation occurred, at which point the twisting rate was lowered to ensure the filament would not break and twisting continued until the entire fibre was coiled. The coiled fibre was then attached at both ends to a rigid board at a neutral length and subject to thermal treatment in an oven at 150°C for 2 h. Whilst the coiled fibre was still hot, it was stretched to 5–10% strain and anchored. A further heat treatment at 150°C for 1 h was applied to set the fibre in place. Several cycles of stretching and heat treatment were performed until the fibre reached 150% of its original length, ensuring the coils were suitably separated (Figure 1).

In some cases the nylon monofilament fibre was co-twisted with a longer length of silver coated nylon

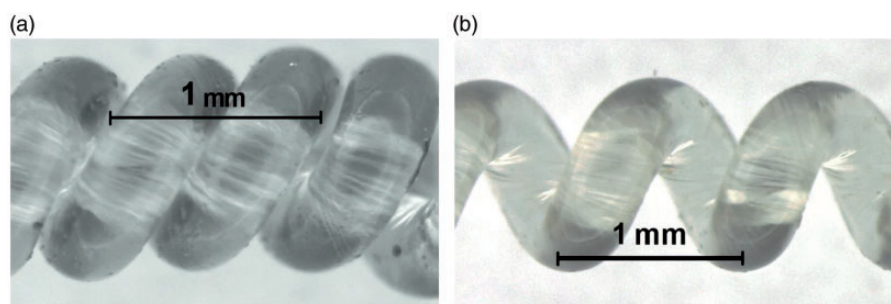

Figure 1. (a) Untreated coiled fibre. The frequency of coils can be observed to be $1.5 \times$ greater than a heat-treated coil. (b) Fibre after heat treatment cycle, stretched out to 150% strain.

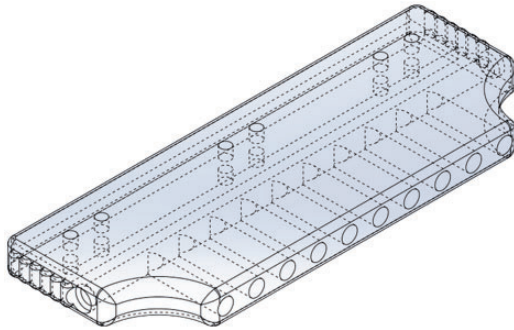

Figure 2. Rapidly prototyped low-profile device housing, designed to utilise readily available hook and eye fasteners. Commercially available bra hook fasteners were fixed into one end of the housing, with the actuator fixed onto the other end. Bra eye fasteners were sewn onto the sample sports bra, allowing the actuator device to be placed and stretched to different initial loadings.

multifilament yarn (Shieldex, USA). The conductive yarn was tightly wrapped around the monofilament and provided a means for electrical heating.

Textile actuating device fabrication

The housing of the textile-actuating device was prototyped using additive fabrication (Objet Connex350, ABS-stimulant material; Figure 2). Segmented lengths of fibres were attached to the device housing using UV curable methacrylate glue, embedding the fibre within the device itself. A three-dimensional (3D) printed loom and shuttle were used to weave cotton fibre through the actuating fibres to reinforce the lateral component of the structure. Silver-coated nylon was also woven into the structure perpendicular to actuating fibres, to provide a heating element for actuation (Figure 3). Thermal resistors (thermistors) were stitched into the fabric to allow accurate thermal monitoring. Interconnects between the silver coated nylon and electronics were formed by using water-based wire glue to adhere the fibres to metal pins. Finally, control of the device was achieved using a Freetronics Leostick microcontroller (Freetronics Pty Ltd, Croydon Hills, Australia). A feedback loop was set up where the temperature of the fabric was determined and transistor-regulated current allowed to pass through the silver-coated nylon only if the temperature was below a pre-set threshold. The actuating textile only generates a contractile force in the direction of the actuating Baughman muscle fibres. Therefore, the actuating textile is positioned on the bra to maximise the effectiveness of this force generation.

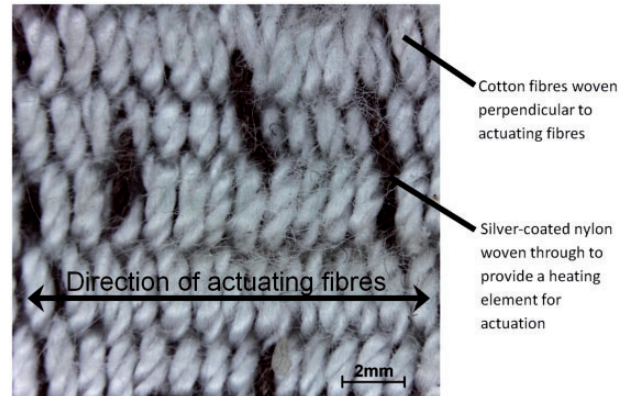

Figure 3. Close-up photograph of fabric structure showing cotton support fibres woven perpendicular to actuating fibres, and silver-coated nylon woven through to provide the heating element for actuation.

Actuation testing

The textile-actuating device and individual actuator fibres were characterised using temperature-dependant force calibration plots. A known length of fibre or textile was mounted at zero strain into an EZ Mechanical Tester (Shimadzu Ltd, Kyoto, Japan). The machine was set to measure force over time, while maintaining a constant strain. Current was applied at constant voltage to the silver-coated nylon wrapped around the coiled fibres or woven into the actuating textile. Alternatively, the sample was enclosed in a small tube furnace for controlled heating tests. Temperature and force were recorded as a function of time, with a linear response within a target operational range of ambient room temperature to $< 80^{\circ}\text{C}$ (the maximum temperature deemed safe for use in the bra application). Fibre or textile temperature was recorded using an infrared thermal imaging camera (Micro- EPSILON, TIM160) and thermistor (Honeywell 100K Thermistor, 135-104LAG-J01).

Results

Sensor evaluation

Clean electronic signals were obtained from the bending-type sensors. The amplitude of the signal voltages (minimum peak to maximum peak) between walking (0.4 mV) and running (5 mV) were obvious and clearly distinct from the background electronic noise (Figure 4). The recoil observed with the PPy coated textile sensor¹² was absent. Therefore, it was concluded that the bending sensor was superior to the PPy coated textile sensor due to greater sensitivity to small strain values, low noise and minimal signal drift. In addition, as the sensor was encased it showed improved

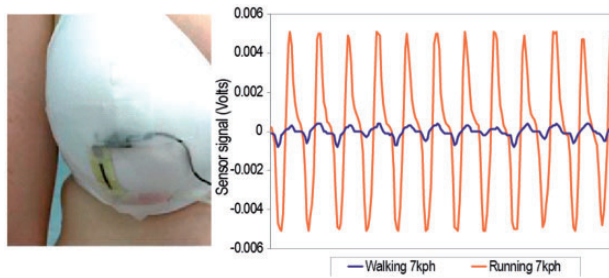

Figure 4. Raw voltage output from the mechanical bending sensor located on the inferior aspect of the bra cup for the participant (bra size 14C) walking and jogging (both at 7 kph).

immunity to the environment compared to the textile sensors. This is important because wearable sensors need to be robust against external physical, electrical and electromagnetic disturbances, as well as impervious to factors such as sweat, moisture, and temperature fluctuations.¹⁷ Currently, the small output signals of the bending sensors are detected by hardwiring directly to a high-quality laboratory data collection system. Further work is required to develop appropriate electronics for on-board signal amplification and transmission.

Actuator evaluation

Evaluation of force generation. Both individual Baughman muscle fibres and actuating textiles were evaluated for their force generation. As shown in Figure 5(a), a maximum force of ~ 0.7 N was achieved within 5–6 s in a single coiled fibre using an electrical input of 12.0 V (at approximately 250 mA with supply current varying slightly, due to variation in the heating element resistance). The electrical heating increased the coiled fibre temperature from ambient to around 80°C and the force generated closely tracked the measured temperature. Adjusting the input electrical power controlled the rate of heating and maximum force generated. The device relaxed back to near the base-line force (approximately 0.03 N) upon cooling. These results were confirmed by furnace heating tests (Figure 5(b)) where individual coiled fibres (without a wrapped heating element) generated approximately 0.6 N when heated to from 25°C to 75°C . The results also indicate that forces of up to 3 N could be attained from the textile-actuating device consisting of nine parallel polymer coils when electrically heated to $\sim 80^{\circ}\text{C}$ (Figure 6). Force generation increased with temperature and a maximum force of 6.5 N was achieved at a fabric temperature of 135°C . At the same measured temperature of $\sim 80^{\circ}\text{C}$, the textile actuating band with nine parallel actuating coiled fibres generated approximately five times the force of a single actuating fibre. Uneven

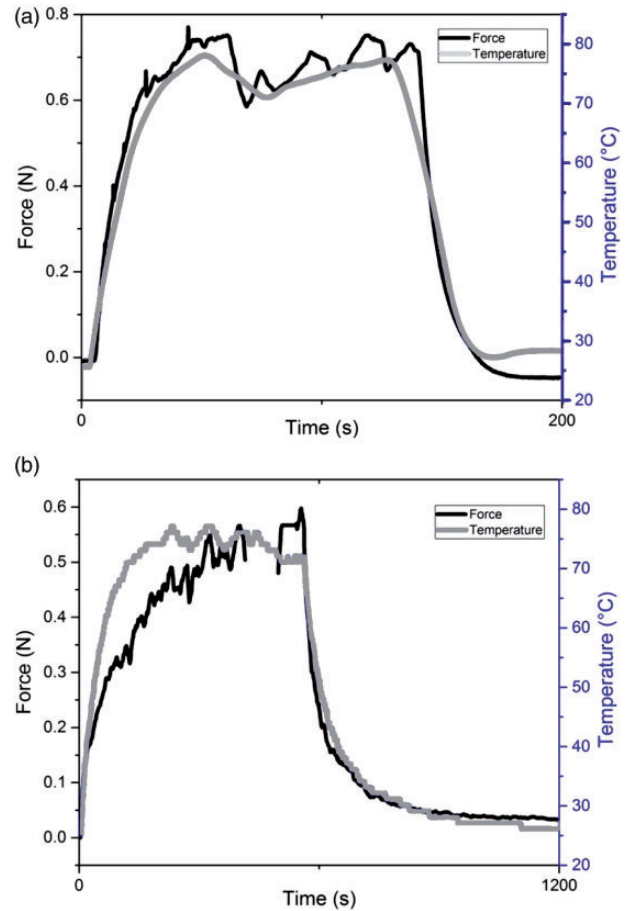

Figure 5. Force and temperature response curves for a single actuating coiled Baughman muscle fibre electrically heated when 12 V was applied to the silver-coated nylon yarn wrapped around the Baughman muscle (a) or when heated to 75°C in a temperature-controlled oven (b).

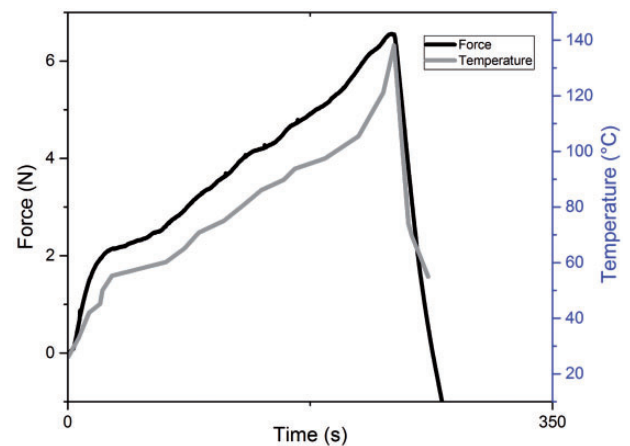

Figure 6. Force and temperature response curve for an actuating textile. Power was supplied to the heating element for 1 min, and then the current was removed and the actuator returned to a relaxed stretched length.

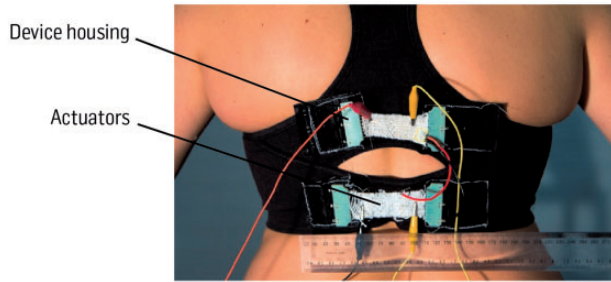

Figure 7. Two actuator systems placed in parallel on the back band of a bra. Electrical connections for powering the actuator systems are shown.

heating of the fibres due to the sparsely woven electrical heating fibre in the textile is likely to have contributed to the slightly lower than expected force. Further improvements to the heating elements included in the actuating textile are currently under investigation.

Evaluation of an actuator device integrated into a bra. Two textile actuating devices were placed horizontally and in parallel on the back of a commercially available compression sports bra (Brand: Champion, Style: WB2374, Size: Medium; Figure 7), worn by a female participant (age = 20 years, mass = 68.2 kg; height = 1.61 m; bra size = 12 E). The bra was fitted to the participant according to professional bra fit criteria.¹⁸ Although fitted, subjective feedback from the participant indicated that she felt the bra did not compress her breasts enough to limit her breast motion during exercise. The purpose of this actuator position was to assess whether textile device actuation could increase the level of breast compression while the participant stood stationary and while running on a treadmill. Breast compression by the bra was evaluated by measuring the pressure exerted on the participant's torso by the bra side band. To assess changes in left and right band pressure during the static standing trials, two calibrated Pliance[®] pressure mats (4 × 16 cm² sensors; novel[®], Munich, Germany) were adhered directly onto the participant's torso, extending from the edge of her breast tissue towards her back on both sides of her torso. Two trials of mean bra band pressure data (N/cm²; 10 s each) were then collected with the actuator device de-activated (Figure 8). The actuator device was then activated and a further 10 trials of pressure data (10 s each) were collected with the actuator 'on', in order to examine the pressure sustained over this period of time.

Following pressure data collection, the actuator device was switched off and a short break (~2–5 min) was taken for the actuator to cool down and to allow the bra to return to its original state. The participant then ran on a treadmill (SportsArt T650ME, Tainan

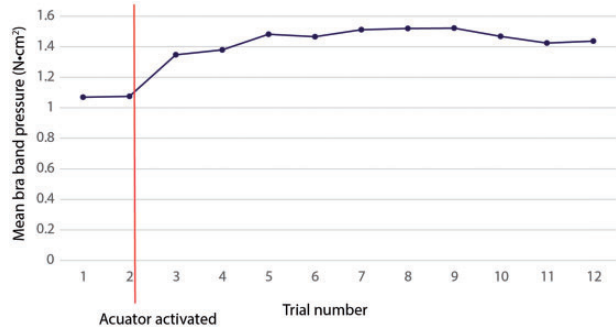

Figure 8. Mean bra band pressure (N/cm²) measured for one participant before and after the bra actuator was activated, over 12 trials (10 s each).

Table 1. Subjective visual analogue scale (VAS; 0–5 scale) data for one participant's perceived breast movement, breast discomfort and bra discomfort, when the actuator was de-activated and activated.

| Actuator status | Breast movement | Breast discomfort | Bra discomfort |
|-----------------|-----------------|-------------------|----------------|
| De-activated | 3.5 | 3.8 | 2.9 |
| Activated | 2.6 | 2.9 | 1.9 |

City, Taiwan) at 10 kph for 3 min duration. Immediately after running, the participant was asked to mark her perceived levels of bra discomfort, perceived breast motion, and any associated breast motion discomfort on a 5 inch visual analogue scale (VAS) with no discomfort or movement at the '0' end of the scale, and worst possible discomfort or extreme movement at the '5' end of the scale. The actuator device was then activated and the running trial and associated VAS data collection were repeated.

Mean pressure for the left and right bra bands were averaged to produce the total mean bra band pressure over the 12 trials. As expected, bra band pressure increased significantly when the actuator was activated, and maintained this level of pressure throughout activation (Figure 8). Before activation, the bra band exerted a mean pressure of slightly more than 1 N/cm² due to elastic stretching of the bra material. Activation of the actuators increased this mean pressure by ~50% to 1.5 N/cm² by further stretching the bra material around the wearer's torso. Subjective data presented in Table 1 indicated that the participant was able to perceive the change in breast support provided by tightening of the bra as the actuator was activated, and this resulted in improved breast and bra comfort, as well as a perceived decrease in breast movement during running.

Discussion

A bra that can respond to the needs of the wearer by changing its physical characteristics to provide more support during higher levels of physical activity and then relaxing into a more comfortable state during periods of relative inactivity would foster the comfort of many women and, in turn, enhance active living. Such a bra would require a ‘sensor’ that is responsive to an increase in breast movement, and an ‘actuator’ that is responsive to output from the sensor and could adjust the supportive elements in the bra. This study aimed to identify a sensor suitable for monitoring and providing feedback on increasing amplitude and frequency of breast motion, and to identify an appropriate actuator that when activated was capable of increasing the breast support provided by a bra. Results of this research confirm that sensors made from electromaterials were able to detect changes in the amplitude and frequency of breast motion during walking and running. Furthermore, actuators made from electrothermally driven artificial muscles could be initiated to contract, tightening the bra, and providing additional breast support for the wearer. Practicalities and implications associated with these results are discussed below.

The efficacy and limitations of PPy-coated textile sensors in detecting breast motion have been published elsewhere,¹² and so this study focused on use of a more robust encased polypyrrole mechanical bending sensor. Although PPy-coated textile sensors provide output based on stretch, as the name implies, the mechanical bending sensor relies on bending to generate a signal. For this reason, the mechanical bending sensor was positioned where breast displacement was most likely to bend the sensor. Results of the present study established that placing the mechanical bending sensor around the curved area at the base of the bra cup (placed vertically from the most inferior portion of the bra cup to 1.5 cm below and 1 cm lateral of the nipple away from the sternal line; Figure 4) provides very clean electronic signals with clear signal differences between walking and running. Therefore, these sensors could be integrated into a Bionic Bra design to indicate a change in the amplitude of breast motion. Their exact placement, however, would depend on ease of integration, as well as identifying a part of the bra that was least likely to fail, and a location that would not interfere with or cause discomfort to the breasts. For example, respondents may not like an active component sitting directly on top of their breast tissue. Table 2 summarises some aspects that should be considered when deciding which sensor might be most suitable to integrate into a Bionic Bra design.

This was the first study to examine the efficacy of Baughman coiled polymer fibre artificial muscles as

actuators for tightening a bra, and the results are promising. Bench top analysis revealed that the actuators produced up to 3 N of force when electrically heated to $\sim 80^{\circ}\text{C}$. When integrated into a bra, the actuator elements caused a $\sim 50\%$ increase in bra band pressure on the wearer’s torso. Subjective feedback indicated a slight decrease in perceived breast movement, and an increase in breast and bra comfort following actuator activation. Further research is therefore needed to confirm or refute these results in an appropriately powered sample of participants of varying breast size. Furthermore, objective measures of breast motion, such as vertical breast displacement, should be also incorporated into future research to ascertain whether the increased bra band pressures were sufficient to decrease breast motion. Nevertheless, these results indicated that Baughman muscles could be initiated to contract, tightening the bra to provide additional support to the wearer, and there is scope for further investigation in the use of coiled artificial muscles in bra technology.

Despite the evidence showing that a sensor can detect changes in breast motion and an actuator can be activated to tighten the bra to provide more perceived support, integrating these components into a wearable garment, that can be washed and worn, remains challenging. Essentially, the electronics for such a bra would need two components, a circuit used to amplify the signal supplied by the sensor and a circuit used to deliver control signals to the actuator. Furthermore, the sensor would need to be coupled with the actuator, with electronics that could integrate the sensor information and provide information to the actuator to respond, and all components would need to be powered. Although the electrical input to power the actuator is at a low level, future developments would incorporate an electrical insulation coating to avoid any issues with short-circuiting and to improve durability. The future prototypes would also require temperature-sensing elements for feedback control and to prevent any excessive force application.

Being such a sensitive part of the body, there are likely to also be concerns about where electronics and batteries are placed on the bra and women might prefer not to have any active components placed on or around their breast tissue. These restrictions mean that active components may need to be placed in other areas of the bra, most likely on the bra band on the wearer’s back. Furthermore, given a bra is such a personal item of apparel, support must be considered subjectively as well as objectively. That is, how comfortable a bra feels to the wearer is a key outcome for any bra design study, and the perceptions of the wearer towards the look and feel of the bra must be carefully considered in the ultimate design of a Bionic Bra. We emphasise that this manuscript is focussed on demonstrating the proof of

Table 2. Aspects to consider when choosing either the PPy coated textile stretch sensor or the PPy film type-bending sensor in the Bionic Bra application.

| Fabric Stretch Sensor | Film Bending Sensor |
|--|--|
| Soft fabric construction (nylon Lycra) that does not increase stiffness of bra structure | Need to be encased to prevent drying of the electrolyte in the sensor, resulting in additional stiffness to the bra cup compared to the fabric sensor |
| Signal drift due to changing electrical properties of PPy coating due to: <ul style="list-style-type: none"> ○ inherent 'creep' of base textile ○ 'aging' of the coating and 'stretching' of the original fabric sample after repeated elongation, especially at larger strains ○ environmental instability of the conducting coating, especially in humid environments | Minimal signal drift as these sensors do not 'age' like the fabric sensors. They are protected from the environment by the casing. |
| Best positioned vertically from the most superior portion of the bra strap to 4 cm above the nipple; sensor length approximately 120-135 mm | Best positioned vertically from the most inferior portion of the bra cup to 1.5 cm below and 1 cm lateral of the nipple away from the sternal line; sensor length approximately 30-40 mm |
| Need to pre-strain to 20% for there to be a linear change in resistance with strain. A larger strain amplitude is needed to elucidate the signal from the electronic 'noise' originating from the baseline drift, natural creep of the nylon Lycra fabric and the 'recoil' effect | Can detect signals at lower strains due to a low noise signal and no inherent creep within the sensor |
| Reference voltage to induce signal (battery required) | No battery required in principle (energy harvesting) |
| Signal requires no amplification (output in V) | The signal may require amplification in the circuit (output in mV) |

principle of a responsive bra concept. Further development is needed to build a practical device including the appropriate electrical components, wiring, power supply and to solve issues relating to washability, durability and aesthetics.

Finally, adequate breast support is unlikely to be achieved by any one sports bra structure or design across a range of breast shapes and sizes.⁵ The ability to change the physical characteristics of a bra might therefore still be limited by the inherent structural design of the bra. Although the Bionic Bra revolutionises the sports bra concept towards providing a bra that responds to the individual needs of women to minimise bra discomfort, much work is still required to design better bra structures to accommodate this technology.

Conclusion

Highly supportive sports bras, while effective in controlling breast motion and associated breast pain, are deemed uncomfortable to wear, and as a result many

women report exercise bra discomfort. Given that exercise bra discomfort is associated with decreased levels of physical activity, there is a pertinent need to develop innovative solutions to address this problem. Using electromaterials and artificial muscle technology to create a bra that is comfortable to wear, but capable of detecting increases in breast motion, and respond with increased breast support, might provide a solution. These sensor and actuator technologies were developed and evaluated for this specific purpose in this study, and results indicate that, when assessed in isolation, the technologies are capable of sensing breast motion and providing some additional breast support. The challenge now lies in integrating both technologies into a functional Bionic Bra prototype, and assessing this prototype in a controlled biomechanical analysis. Furthermore, due to the highly personal nature of bras, consumers must be engaged to ensure the final prototype meets its objective goals of responding to, and reducing breast motion, as well as the subjective criteria of comfort, fit and aesthetics. When successful, the Bionic Bra will transform sports bra technology,

and provide a solution that will enable women to exercise in comfort and, in turn, enhance active living.

Declaration of conflicting interests

The author(s) declared no potential conflicts of interest with respect to the research, authorship, and/or publication of this article.

Funding

The author(s) disclosed receipt of the following financial support for the research, authorship, and/or publication of this article: This work was supported by the Australian Research Council Centre of Excellence Scheme (Project Number CE 140100012).

Guarantor

JRS

Contributorship

All authors contributed to the design of the study. TEC collected and analysed data related to the sensors, whereas SAG and CJR collected and analysed data related to the actuators. All authors contributed to the interpretation of the data. JRS, SAG, TEC and CJR wrote the manuscript. All authors reviewed and revised it critically for important intellectual content. All authors read and approved the final manuscript.

Acknowledgement

The authors thank the Australian National Fabrication Facility – Materials node for providing access to facilities and equipment to conduct this research.

ORCID iD

Julie R Steele  <http://orcid.org/0000-0002-2089-406X>

References

1. Bowles K-A, Steele JR and Munro B. What are the breast support choices of Australian women during physical activity? *Br J Sports Med* 2008; 42: 670–673.
2. Page K-A and Steele JR. Breast motion and sports brassiere design. Implications for future research. *Sports Med* 1999; 27: 205–211.
3. Mason BR, Page K-A and Fallon K. An analysis of movement and discomfort of the female breast during exercise and the effects of breast support in three cases. *J Sci Med Sport* 1999; 2: 134–144.
4. Lawson L and Lorentzen D. Selected sports bras: Comparisons of comfort and support. *Cloth Text Res J* 1990; 8: 55–60.
5. McGhee DE, Steele JR, Zealey WJ, et al. Bra-breast forces generated in women with large breasts while standing and during treadmill running: Implications for sports bra design. *Appl Ergon* 2013; 44: 112–118.
6. Gehlsen G and Albohm M. Evaluation of sports bras. *Phys Sportsmed* 1980; 8: 89–95, 97.
7. Starr C, Branson D, Shehab R, et al. Biomechanical analysis of a prototype sport bra. *J Textile Appar Technol Manag* 2005; 4: 1–14.
8. De Rossi D, Della Santa A and Mazzoldi A. Dressware: wearable hardware. *Mater Sci Eng C* 1999; 7: 31–35.
9. Fletcher R. Force transduction materials for human-technology interfaces. *IBM Syst J* 1996; 35: 630–638.
10. Wallace GG, Campbell TE and Innis PC. Putting function into fashion: organic conducting polymer fibres and textiles. *Fiber Polym* 2007; 8: 135–142.
11. Munro BJ, Campbell TE, Wallace GG, et al. The intelligent knee sleeve: a wearable biofeedback device. *Sensor Actuator B-Chem* 2008; 131: 541–547.
12. Campbell TE, Munro BJ, Wallace GG, et al. Can fabric sensors monitor breast motion? *J Biomech* 2007; 40: 3056–3059.
13. Wu Y, Alici G, Madden JDW, et al. Soft mechanical sensors through reverse actuation in polypyrrole. *Adv Funct Mater* 2007; 17: 3216–3222.
14. Alici G, Spinks GM, Madden JD, et al. Response characterization of electroactive polymers as mechanical sensors. *IEEE/ASME Transact Mechatron* 2008; 13: 187–196.
15. Naficy S, Stoboi N, Whitten PG, et al. Evaluation of encapsulating coatings on the performance of polypyrrole actuators. *Smart Mater Struct* 2013; 22: 075005.
16. Haines CS, Lima MD, Li N, et al. Artificial muscles from fishing line and sewing thread. *Science* 2014; 343: 868–872.
17. Munro BJ, Steele JR, Campbell TE, et al. Wearable biofeedback systems. In: Mattila HR (ed.) *Intelligent textiles and clothing*. Cambridge, UK: Woodhead Publishing Limited, 2006, Chapter 24, pp.450–470.
18. McGhee DE and Steele JR. Optimising breast support in female patients through correct bra fit: a cross-sectional study. *J Sci Med Sport* 2010; 13: 568–572.