

Frank T. Bergmann^{1,2} / Jonathan Cooper³ / Matthias König⁴ / Ion Moraru⁵ / David Nickerson⁶ /
Nicolas Le Novère⁷ / Brett G. Olivier^{1,2,8} / Sven Sahle¹ / Lucian Smith⁹ / Dagmar Waltemath¹⁰

Simulation Experiment Description Markup Language (SED-ML) Level 1 Version 3 (L1V3)

¹ Modelling of Biol. Processes, BioQUANT/COS, Heidelberg University, Heidelberg, Germany.

<http://orcid.org/0000-0001-5553-4702>, <https://orcid.org/0000-0002-5293-5321>.

² Department of Computing and Mathematical Sciences, California Institute of Technology, Pasadena, CA, USA.

<http://orcid.org/0000-0001-5553-4702>, <https://orcid.org/0000-0002-5293-5321>.

³ Department of Computer Science, University of Oxford, Oxford, UK. <https://orcid.org/0000-0001-6009-3542>.

⁴ Department of Biology, Humboldt University, Berlin, Germany, E-mail: koenigmx@hu-berlin.de.

<http://orcid.org/0000-0003-1725-179X>.

⁵ Department of Cell Biology, University of Connecticut, Connecticut, USA

⁶ Auckland Bioengineering Institute, Auckland, New Zealand. <https://orcid.org/0000-0003-4667-9779>.

⁷ Babraham Institute Cambridge, Cambridgeshire, UK. <https://orcid.org/0000-0002-6309-7327>.

⁸ Systems Bioinformatics, AIMMS, Vrije Universiteit Amsterdam, Amsterdam, The Netherlands.

<https://orcid.org/0000-0002-5293-5321>.

⁹ University of Washington, Seattle, WA, USA. <https://orcid.org/0000-0001-7002-6386>.

¹⁰ University of Rostock, Rostock, Germany. <https://orcid.org/0000-0002-5886-5563>.

Abstract:

The creation of computational simulation experiments to inform modern biological research poses challenges to reproduce, annotate, archive, and share such experiments. Efforts such as SBML or CellML standardize the formal representation of computational models in various areas of biology. The Simulation Experiment Description Markup Language (SED-ML) describes what procedures the models are subjected to, and the details of those procedures. These standards, together with further COMBINE standards, describe models sufficiently well for the reproduction of simulation studies among users and software tools. The Simulation Experiment Description Markup Language (SED-ML) is an XML-based format that encodes, for a given simulation experiment, (i) which models to use; (ii) which modifications to apply to models before simulation; (iii) which simulation procedures to run on each model; (iv) how to post-process the data; and (v) how these results should be plotted and reported. SED-ML Level 1 Version 1 (L1V1) implemented support for the encoding of basic time course simulations. SED-ML L1V2 added support for more complex types of simulations, specifically repeated tasks and chained simulation procedures. SED-ML L1V3 extends L1V2 by means to describe which datasets and subsets thereof to use within a simulation experiment.

Keywords: Simulation experiment, computational modeling, reproducibility

DOI: 10.1515/jib-2017-0086

Received: December 31, 2017; **Accepted:** February 2, 2018

Matthias König is the corresponding author.

 ©2018, Frank T. Bergmann et al., published by De Gruyter.

This work is licensed under the Creative Commons Attribution-NonCommercial-NoDerivatives 4.0 License.

Simulation Experiment Description

Markup Language (SED-ML) :

Level 1 Version 3

December 31, 2017

Editors

Frank T Bergmann
Jonathan Cooper
Matthias König
Ion Moraru
David Nickerson
Nicolas Le Novère
Brett G Olivier
Sven Sahle
Lucian Smith
Dagmar Waltemath

Caltech, USA
University of Oxford, UK
Humboldt University Berlin, Germany
University of Connecticut, USA
Auckland Bioengineering Institute, New Zealand
Babraham Institute Cambridge, UK
University Amsterdam, Netherlands
Heidelberg University, Germany
University of Washington, USA
University of Rostock, Germany

The latest release of the Level 1 Version 3 specification is available at
<http://identifiers.org/combine.specifications/sed-ml.level-1.version-3>

To discuss SED-ML and the SED-ML specification write to the mailing list
sed-ml-discuss@googlegroups.com.

To contact the SED-ML editors write to sed-ml-editors@googlegroups.com.



1	Introduction	6
1.1	SED-ML overview	6
1.2	Example simulation experiment	7
1.2.1	Time-course simulation	7
1.2.2	Applying pre-processing	8
1.2.3	Applying post-processing	8
2	SED-ML technical specification	10
2.1	General data types, attributes and classes	11
2.1.1	Primitive data types	11
2.1.1.1	ID	11
2.1.1.2	SId	11
2.1.1.3	SIdRef	11
2.1.1.4	XPath	11
2.1.1.5	MathML	12
2.1.1.6	anyURI	12
2.1.1.7	NuMLSid	12
2.1.1.8	NuMLSidRef	12
2.1.2	SEDBase	12
2.1.3	Notes	13
2.1.4	Annotation	13
2.1.5	Parameter	14
2.1.6	Variable	14
2.1.7	General attributes	16
2.1.7.1	id	17
2.1.7.2	name	17
2.1.7.3	math	17
2.1.7.4	kisaoID	17
2.1.7.5	listOf* containers	17
2.1.7.6	listOfParameters	17
2.1.7.7	listOfVariables	17
2.1.8	Reference relations	18
2.1.8.1	modelReference	18
2.1.8.2	simulationReference	19
2.1.8.3	taskReference	19
2.1.8.4	dataReference	19
2.2	SED-ML Components	21
2.2.1	SED-ML top level element	21
2.2.1.1	xmlns	23
2.2.1.2	level	23
2.2.1.3	version	23

2.2.1.4	listOfDataDescriptions	23
2.2.1.5	listOfModels	24
2.2.1.6	listOfSimulations	24
2.2.1.7	listOfTasks	24
2.2.1.8	listOfDataGenerators	24
2.2.1.9	listOfOutputs	25
2.2.2	DataDescription	25
2.2.3	DataDescription components	26
2.2.3.1	DimensionDescription	26
2.2.3.2	DataSource	27
2.2.3.3	Slice	28
2.2.4	Model	29
2.2.5	Change	31
2.2.5.1	NewXML	32
2.2.5.2	AddXML	33
2.2.5.3	ChangeXML	33
2.2.5.4	RemoveXML	33
2.2.5.5	ChangeAttribute	34
2.2.5.6	ComputeChange	34
2.2.6	Simulation	36
2.2.6.1	UniformTimeCourse	37
2.2.6.2	OneStep	38
2.2.6.3	SteadyState	39
2.2.7	Simulation components	39
2.2.7.1	Algorithm	39
2.2.7.2	AlgorithmParameter	40
2.2.8	AbstractTask	40
2.2.8.1	Task	41
2.2.8.2	Repeated Task	42
2.2.9	Task components	44
2.2.9.1	SubTask	44
2.2.9.2	SetValue	44
2.2.9.3	Range	45
2.2.10	DataGenerator	47
2.2.11	Output	49
2.2.11.1	Plot2D	50
2.2.11.2	Plot3D	51
2.2.11.3	Report	51
2.2.12	Output components	52
2.2.12.1	Curve	52

2.2.12.2	Surface	53
2.2.12.3	DataSet	54
3	Concepts used in SED-ML	55
3.1	MathML	55
3.1.1	MathML elements	55
3.1.2	MathML symbols	55
3.1.3	MathML functions	55
3.1.4	NA values	56
3.2	URI scheme	56
3.2.1	Model references	57
3.2.2	Data references	57
3.2.3	Language references	57
3.2.4	Data format references	58
3.2.4.1	NuML (Numerical Markup Language)	58
3.2.4.2	CSV (Comma Separated Values)	59
3.2.4.3	TSV (Tab Separated Values)	60
3.2.5	Symbols	60
3.2.6	Annotation Scheme	60
3.3	XPath	60
3.4	NuML	61
3.5	KiSAO	61
3.6	COMBINE archive	61
3.7	SED-ML resources	62
4	Acknowledgements	63
A	Examples	64
A.1	Example simulation experiment (<code>L1V3_repressilator.omex</code>)	64
A.2	Simulation experiments with <code>dataDescriptions</code>	67
A.2.1	Plotting data with simulations (<code>L1V3_plotting-data-numl.omex</code>)	67
A.3	Simulation experiments with <code>repeatedTasks</code>	69
A.3.1	Time course parameter scan (<code>L1V3_repeated-scan-oscli.omex</code>)	69
A.3.2	Steady state parameter scan (<code>L1V3_repeated-steady-scan-oscli.omex</code>)	70
A.3.3	Stochastic simulation (<code>L1V3_repeated-stochastic-runs.omex</code>)	71
A.3.4	Simulation perturbation (<code>L1V3_oscli-nested-pulse.omex</code>)	73
A.3.5	2D steady state parameter scan (<code>L1V3_parameter-scan-2d.omex</code>)	75
A.4	Simulation experiments with different model languages	78
A.4.1	Van der Pol oscillator in SBML (<code>L1V3_vanderpol-sbml.omex</code>)	78
A.4.2	Van der Pol oscillator in CellML (<code>L1V3_vanderpol-cellml.omex</code>)	80
A.5	Reproducing publication results	83
A.5.1	Le Loup model (<code>L1V3_leloup-sbml.omex</code>)	83

A.5.2 IkappaB signaling (L1V3_ikkapab.omex)	85
B XML Schema	87

1. Introduction

The Simulation Experiment Description Markup Language (SED-ML) is an XML-based format for the description of simulation experiments.

The number of computational models of biological systems is growing at an ever increasing pace. At the same time, their size and complexity are also increasing. It is now generally accepted that one must be able to exchange the mathematical structure of such models, for instance to build on existing studies by reusing models or for the reproduction of model results. The efforts to standardize the representation of computational models in various areas of biology, such as the Systems Biology Markup Language (SBML) [14], CellML [8] or NeuroML [11], resulted in an increase of the exchange and re-use of models. However, the description of models is not sufficient for the reproduction of simulation experiments and results. One also needs to describe the procedures the models are subjected to, i.e., the information that must be provided to allow the reproduction of simulation experiments among users and software tools. The increasing use of computational simulation experiments to inform modern biological research creates new challenges to reproduce, annotate, archive, and share such experiments.

SED-ML describes in a computer-readable exchange format the information for the reproduction of simulation experiments. SED-ML is a software-independent format encoded in XML not specific to particular simulation tools and independent of the underlying model language. SED-ML describes the minimum information of a simulation experiment as described by the Minimum Information About a Simulation Experiment (MIASE) [19].

SED-ML is developed as a community project and defined via a detailed technical specification and a corresponding XML Schema.

This document describes Level 1 Version 3 of SED-ML which is the successor of Level 1 Version 2 and Level 1 Version 1 (described in [20]).

1.1 SED-ML overview

SED-ML specifies for a given simulation experiment

- what datasets to use ([DataDescription](#));
- which models to use ([Model](#));
- which modifications to apply to models before simulation ([Change](#));
- which simulation procedures to run on each model ([Simulation](#), and [Task](#));
- what analysis results to plot or report and how to post-process the data ([DataGenerator](#)); and
- how these results should be presented ([Output](#)).

A [SED-ML document](#) contains the following main objects to describe this information: [DataDescription](#), [Model](#), [Change](#), [Simulation](#), [Task](#), [DataGenerator](#), and [Output](#).

[DataDescription](#)

The [DataDescription](#) class allows to specify datasets for a simulation experiment. Such data can be used for instance for parametrization of model simulations or to plot data together with simulation results.

Model

The `Model` class allows to reference the models used in a simulation experiment.

The `Change` class allows to modify models (pre-processing), i.e., changing the value of an observable, computing the change of a value using mathematics, or general changes on any XML element of the model representation that is addressable by `XPath` expressions, e.g., substituting a piece of XML by an updated one.

Simulation

The `Simulation` class defines the simulation settings and the steps taken during simulation. These include the particular type of simulation, the algorithm, and the algorithm parameters used for the execution of the simulation.

Task

SED-ML uses the `Task` class to specify which `Simulation` is run with which `Model`.

DataGenerator

The `DataGenerator` class allows to encode post-processing of simulation results before the generation of outputs, e.g., one can normalize a variable, or apply post-processing like mean value calculation. In the definition of a `DataGenerator`, any addressable variable or parameter of any model or `DataSource` may be referenced, and new entities might be specified using `MathML`.

Output

The `Output` defines the output of the simulation experiment, which can be either a two dimensional plot (`Plot2D`), a three dimensional plot (`Plot3D`), or data table (`Report`). The `Output` is based on the post-processed simulation results in the `DataGenerators`.

This section provided a low level overview over a simulation experiment in SED-ML. For the detailed technical specification see Chapter 2.

1.2 Example simulation experiment

In this section an example simulation experiment in SED-ML for the repressilator model [9] is presented. The corresponding SED-ML is listed in Appendix A.1, the [COMBINE Archive](#) for this simulation experiment is available as `L1V3_repressilator.omex` from <http://sed-ml.org/>.

The repressilator is a synthetic oscillating network of transcription regulators in *Escherichia coli*. The network is composed of the three repressor genes Lactose Operon Repressor (`lacI`), Tetracycline Repressor (`tetR`) and Repressor CI (`cI`), which code for proteins binding to the promoter of the other, blocking their transcription. The three inhibitions together in tandem, form a cyclic negative-feedback loop. To describe the interactions of the molecular species involved in the network, the authors built a simple mathematical model of coupled first-order differential equations. All six molecular species included in the network (three mRNAs, three repressor proteins) participate in creation (transcription/translation) and degradation processes. The model was used to determine the influence of the various parameters on the dynamic behavior of the system. In particular, parameter values were sought which induce stable oscillations in the concentrations of the system components.

1.2.1 Time-course simulation

The first simulation experiment with the model reproduces the oscillation behavior of the model shown in Figure 1c of the reference publication [9]. This simulation experiment can be described as:

1. Import the repressilator model identified by the Unified Resource Identifier (URI) [3] [urn:miriam:biomodels.db:BIOMD0000000012](http://miriam.org/uri/urn:miriam:biomodels.db:BIOMD0000000012).
2. Select a deterministic simulation method for the numerical integration.
3. Run a uniform time course simulation for 1000 min with an output interval of 1 min.
4. Plot the amount of `lacI`, `tetR` and `cI` against time in a 2D Plot.

Following those steps and performing the simulation experiment in a simulation tool supporting SED-ML results in the output shown in Figure 1.1 and Figure 1.2.

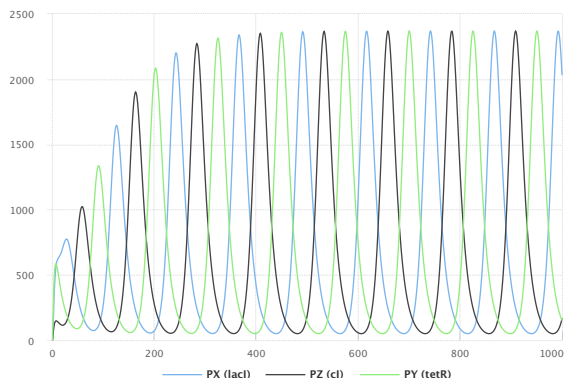

Figure 1.1: Time-course simulation of the repressilator depicting repressor proteins *lacI*, *tetR* and *cI*. Simulation with SED-ML web tools [2].

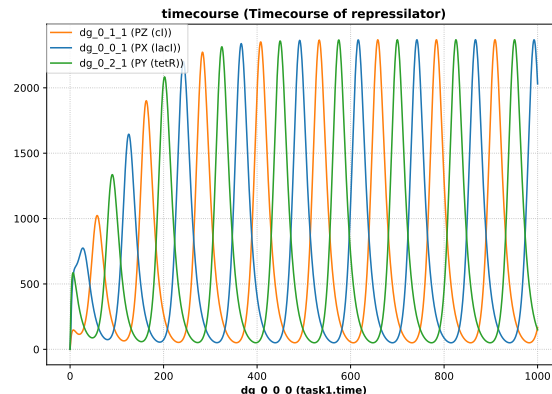

Figure 1.2: Time-course simulation of the repressilator depicting repressor proteins *lacI*, *tetR* and *cI*. Simulation with tellurium [5].

1.2.2 Applying pre-processing

A common step in a simulation experiment is the adjustment of model parameters before simulation. When changing the parameter values for the protein copies per promoter `tps_repr` and the leakiness in protein copies per promoter `tps_active` like stated below, the system's behavior switches from sustained oscillations to damped oscillations. The simulation experiment leading to that behavior is described as:

1. Import the model as in Section 1.2.1 above.
2. Change the value of the parameter `tps_repr` from `0.0005` to `1.3e-05`.
3. Change the value of the parameter `tps_active` from `0.5` to `0.013`.
4. Select a deterministic method.
5. Run a uniform time course for the duration of 1000 min with an output interval of 1 min.
6. Plot the amount of `lacI`, `tetR` and `cI` against time in a 2D Plot.

Figure 1.3 on the following page and Figure 1.4 on the next page show the results of the simulation.

1.2.3 Applying post-processing

In a simulation experiment the raw numerical output of the simulation may be subjected to data post-processing before plotting or reporting. In order to describe the production of a normalized plot of the time-course in the first example (section 1.2.1), depicting the influence of one variable on another (in phase-plane), one performs the additional steps:

(Please note that the description steps 1 - 4 remain as given in Section 1.2.1 above.)

5. Collect `lacI(t)`, `tetR(t)` and `cI(t)`.
6. Compute the highest value for each of the repressor proteins, `max(lacI(t))`, `max(tetR(t))`, `max(cI(t))`.
7. Normalize the data for each of the repressor proteins by dividing each time point by the maximum value, i.e., `lacI(t)/max(lacI(t))`, `tetR(t)/max(tetR(t))`, and `cI(t)/max(cI(t))`.
8. Plot the normalized `lacI` protein as a function of the normalized `cI`, the normalized `cI` as a function of the normalized `tetR` protein, and the normalized `tetR` protein against the normalized `lacI` protein in a 2D plot.

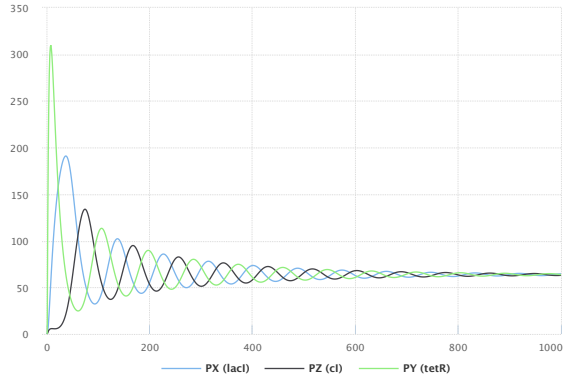

Figure 1.3: Time-course simulation of the repressilator after changing parameters tps_repr and tps_active . Simulation with SED-ML web tools [2].

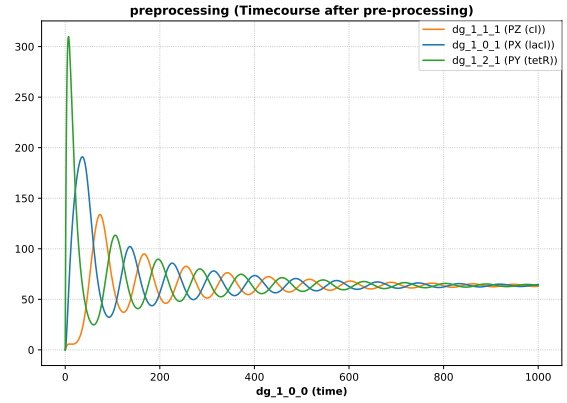

Figure 1.4: Time-course simulation of the repressilator after changing parameters tps_repr and tps_active . Simulation with tellurium [5].

Figure 1.5 and Figure 1.6 show the result of the simulation after post-processing of the output data.

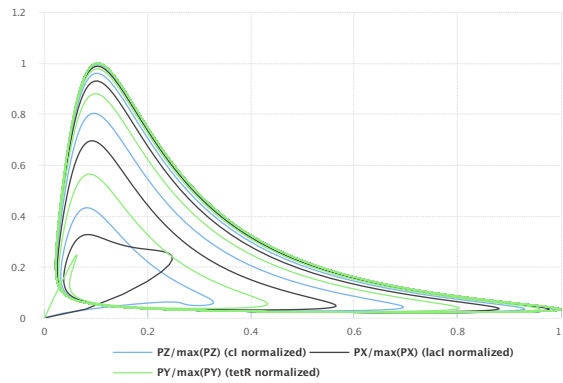

Figure 1.5: Time-course simulation of the repressilator. Normalized $lacI$, $tetR$ and cI in phase-plane. Simulation with SED-ML web tools [2].

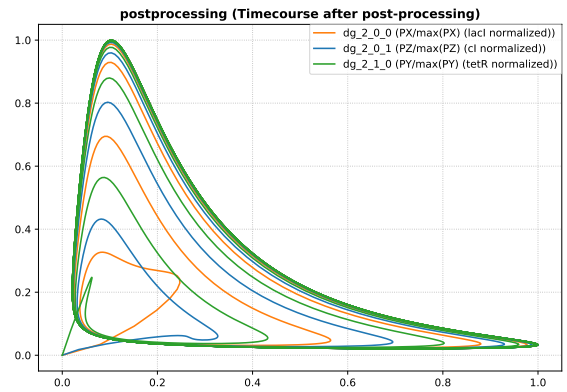

Figure 1.6: Time-course simulation of the repressilator. Normalized $lacI$, $tetR$ and cI in phase-plane. Simulation with tellurium [5].

2. SED-ML technical specification

This document represents the technical specification of SED-ML Level 1 Version 3. The corresponding UML class diagram is shown in Figure 2.1. Example simulation experiments in SED-ML are provided in Appendix A. The XML Schema is provided in Appendix B. However, not all concepts of SED-ML can be captured using XML Schema alone. In such cases this specification is the normative document.

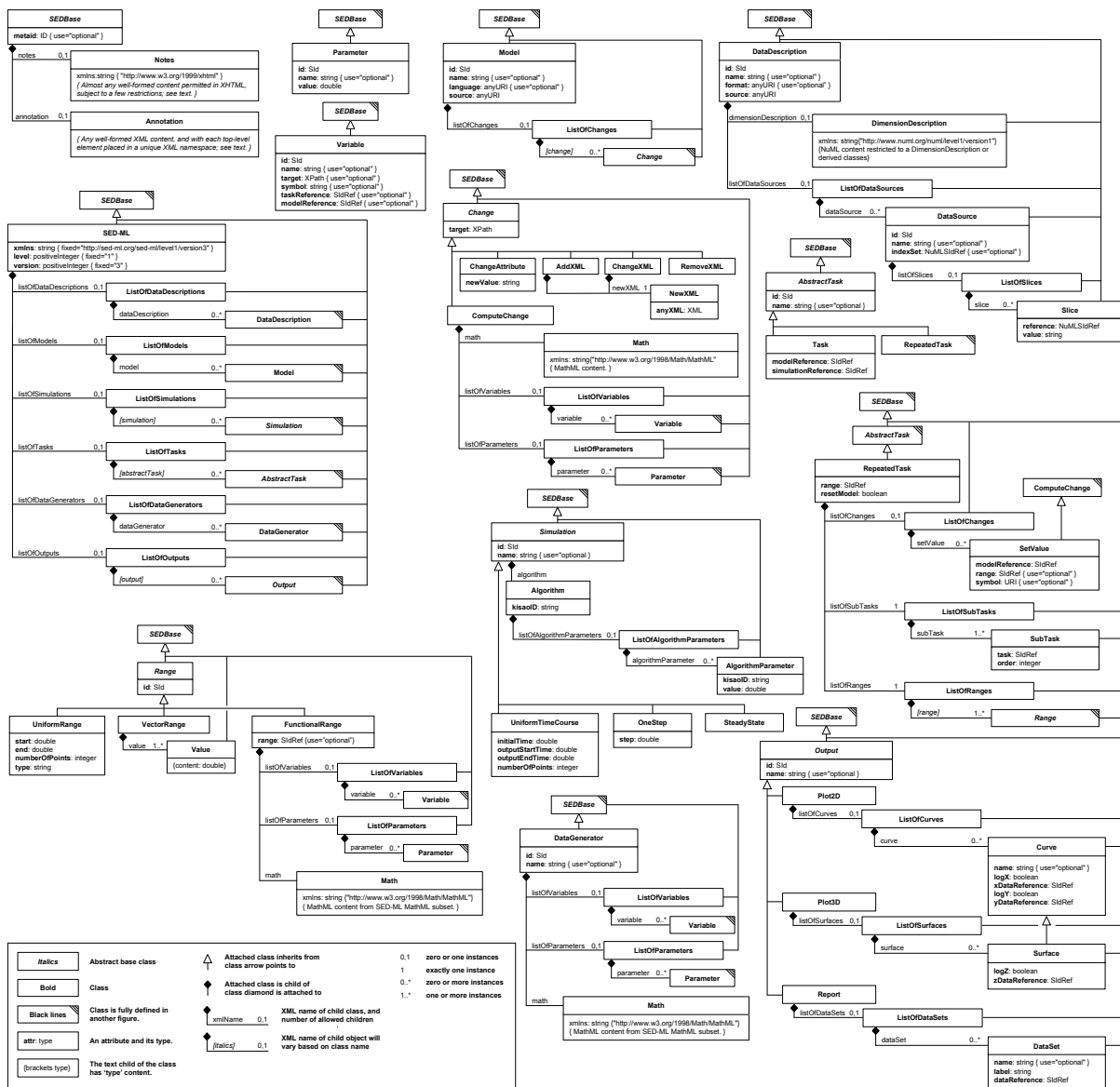

Figure 2.1: The SED-ML Level 1 Version 3 UML class diagram

2.1 General data types, attributes and classes

In this section concepts used repeatedly throughout the SED-ML specification are introduced. This includes [primitive data types](#), classes ([SedBase](#), [Notes](#), [Annotation](#), [Parameter](#), [Variable](#)), [attributes](#), and [reference relations](#).

The main [SED-ML components](#) based on these general data types, attributes and classes are described in [Section 2.2](#).

2.1.1 Primitive data types

Primitive data types comprise the set of data types used in SED-ML classes. Most primitive types in SED-ML are taken from the data types defined in XML Schema 1.0, including `string`, `boolean`, `int`, `positiveInteger`, `double` and `XML`.

A few additional primitive types are defined by SED-ML itself: [ID](#), [SId](#), [SIdRef](#), [XPath](#), [MathML](#), [anyURI](#), [NuMLSId](#), and [NuMLSIdRef](#).

2.1.1.1 Type ID

The XML Schema 1.0 type [ID](#) is identical to the XML 1.0 type `ID`. The literal representation of this type consists of strings of characters restricted as summarized in [Figure 2.2](#). For a detailed description see the SBML specification on type [ID](#) [13].

```
NameChar ::= letter | digit | '.' | '-' | ' ' | ':' | CombiningChar | Extender
ID        ::= ( letter | ' ' | ':' ) NameChar*
```

Figure 2.2: The definition of the type `ID`. The characters `(` and `)` are used for grouping, the character `*` indicates "zero or more times", and the character `|` indicates "or". Please consult the XML 1.0 specification for the complete definitions of `letter`, `digit`, `CombiningChar`, and `Extender`.

2.1.1.2 Type SId

The type [SId](#) is the type of the `id` attribute found on the majority of SED-ML components. [SId](#) is a data type derived from `string`, but with restrictions about the characters permitted and the sequences in which those characters may appear. The definition is shown in [Figure 2.3](#). For a detailed description see the SBML specification on type [SId](#) [13].

```
letter ::= 'a'..'z','A'..'Z'
digit  ::= '0'..'9'
idChar ::= letter | digit | '-'
SId    ::= ( letter | '-' ) idChar*
```

Figure 2.3: The definition of the type `SId`

2.1.1.3 Type SIdRef

Type [SIdRef](#) is used for all attributes that refer to identifiers of type [SId](#) in a model. This type is derived from [SId](#), but with the restriction that the value of an attribute having type [SIdRef](#) must equal the value of some [SId](#) attribute. In other words, a [SIdRef](#) value must be an existing identifier.

As with [SId](#), the equality of [SIdRef](#) values is determined by exact character sequence match; i.e., comparisons of these identifiers must be performed in a case-sensitive manner.

2.1.1.4 Type XPath

Type [XPath](#) is used to identify nodes and attributes within an XML representation. [XPath](#) in SED-ML is an [XPath](#) version 1 expression which can be used to unambiguously identify an element or attribute in an XML file. The concept of [XPath](#) is described in [Section 3.3](#).

2.1.1.5 Type MathML

Type **MathML** is used to describe mathematical expression in **MathML**. The concept of **MathML** and the allowed subset of **MathML** on a **MathML** attribute is described in Section 3.1.

2.1.1.6 Type anyURI

Type **anyURI** is used to reference model and data files, specify the language of models, the format of data files, for referencing implicit model variables, and in annotations. For a description of the uses of **anyURI** see Section 3.2.

2.1.1.7 Type NuMLSid

The type **NuMLSid** is the type of the **id** attribute found on NuML components. **NuMLSid** is a data type derived from **Sid**, with the same restrictions about the characters permitted and the sequences in which those characters may appear as **Sid**. The concept of NuML is described in Section 3.4.

2.1.1.8 Type NuMLSidRef

Type **NuMLSidRef** is used for all attributes that refer to identifiers of type **NuMLSid** in a model. This type is derived from **NuMLSid**, but with the restriction that the value of an attribute having type **NuMLSidRef** must equal the value of some **NuMLSid** attribute. In other words, a **NuMLSidRef** value must be an existing NuML identifier.

As with **NuMLSid**, the equality of **NuMLSidRef** values is determined by exact character sequence match; i.e., comparisons of these identifiers must be performed in a case-sensitive manner.

2.1.2 SEDBase

SEDBase is the base class of all SED-ML classes (Figure 2.4). The **SEDBase** class has the optional attribute **metaid**, and the two optional subelements **notes** and **annotation**.

SEDBase provides means to attach additional information on all other classes. That information can be specified by human readable **Notes** or custom **Annotation**.

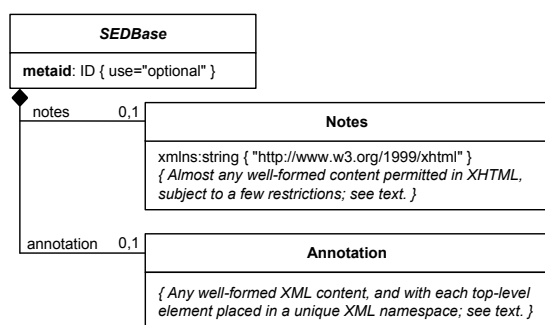

Figure 2.4: The **SEDBase** class

attribute	description
metaid ^o	page 12
sub-elements	description
notes ^o	page 13
annotation ^o	page 13

Table 2.1: Attributes and nested elements for **SEDBase**. ^odenotes optional elements and attributes.

metaid

The main purpose of the **metaid** attribute of data type **ID** is to attach semantic annotations in form of the **Annotation** class to SED-ML elements. The **metaid** attribute is globally unique throughout the SED-ML document, i.e., the **metaid** must be unambiguous throughout a whole SED-ML document. As such it identifies the constituent it is related to.

In order to set either **Notes** or **Annotation** on a SED-ML class the **metaid** is required.

notes

The optional **notes** element stores **Notes** on **SedBase**.

annotation

The optional `annotation` element stores `Annotation` on `SedBase`.

2.1.3 Notes

A `Notes` is considered a human-readable description of the element it is assigned to. Instances of the `Notes` class may contain any valid XHTML [18]. The namespace URL for XHTML content inside the `Notes` class is <http://www.w3.org/1999/xhtml>, which may be declared either in the `sedML` element, or directly in the top level XHTML elements contained within the `notes` element. For details on of how to set the namespace and examples see the SBML specification [13].

Table 2.2 shows all attributes and sub-elements for the `Notes` element.

attribute	description
<code>xmlns:string</code> "http://www.w3.org/1999/xhtml"	page 23
sub-elements	
<i>well-formed content permitted in XHTML</i>	

Table 2.2: Attributes and nested elements for `Notes`. ° denotes optional elements and attributes.

`Notes` does not have any further sub-elements defined in SED-ML, nor attributes associated with it.

Listing 2.1 shows the use of the `notes` element.

```
1 <sedML [...]>
2   <notes>
3     <p xmlns="http://www.w3.org/1999/xhtml">The enclosed simulation description shows the oscillating
4       behaviour of the Repressilator model using deterministic and stochastic simulators.</p>
5   </notes>
6 </sedML>
```

Listing 2.1: The `notes` element

In this example, the namespace declaration is inside the `notes` element and the note is related to the `sedML` root element of the SED-ML file. A note may, however, occur inside *any* SED-ML XML element, except `note` itself and `annotation`.

2.1.4 Annotation

An `Annotation` is considered a computer-processable piece of information. Annotations may contain any valid XML content. For further guidelines on how to use annotations see the SBML specification [13]. The style of annotations in SED-ML is briefly described in Section 3.2.6.

Listing 2.2 shows the use of the `annotation` element. In the example, a `model` element is annotated with a reference to the original publication. The `model` contains an `annotation` that uses the model-qualifier `isDescribedBy` to link to the external resource <http://identifiers.org/pubmed/10415827>. In natural language the annotation content could be interpreted as “The model is described by the published article available from pubmed under the identifier 10415827”.

```
1 <sedML>
2   [...]
3   <model id="model1" metaid="_001" language="urn:sedml:language:cellml" source="goldbeter1999a.cellml"
4     >
5     <annotation>
6       <rdf:RDF xmlns:rdf="http://www.w3.org/1999/02/22-rdf-syntax-ns#" xmlns:bqmodel="http://
7         biomodels.net/model-qualifiers/">
8         <rdf:Description rdf:about="#_001">
9           <bqmodel:isDescribedBy>
10            <rdf:Bag>
11              <rdf:li rdf:resource="http://identifiers.org/pubmed/10415827"/>
12            </rdf:Bag>
13          </bqmodel:isDescribedBy>
14        </rdf:Description>
15      </rdf:RDF>
16    </annotation>
17  </model>
```

```

16 [...]
17 </sedML>

```

Listing 2.2: *The annotation element*

2.1.5 Parameter

The [Parameter](#) class (Figure 2.5) is used to create named parameters with a constant value. The [Parameter](#) class introduces the required attributes [id](#) and [value](#), and the optional attribute [name](#).

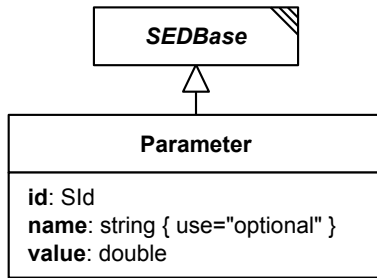

Figure 2.5: *The Parameter class*

attribute	description
metaid ^o	page 12
id	page 17
name ^o	page 17
value	page 14
sub-elements	description
notes ^o	page 13
annotation ^o	page 13

Table 2.3: *Attributes and nested elements for [parameter](#). ^odenotes optional elements and attributes.*

[Parameters](#) can be used wherever a mathematical expression to compute a value is defined, e.g., in [ComputeChange](#), [FunctionalRange](#) or [DataGenerator](#). The [Parameter](#) definitions are local to the particular class defining them. By using [Parameters](#) rather than including numbers directly within a mathematical expression is that [notes](#) and [annotations](#) can be associated with them.

Listing 2.3 shows the use of the `parameter` element. In the example a [parameter](#) `p1` with the value `40` is defined.

```

1 <listOfParameters>
2   <parameter id="p1" name="KM" value="40" />
3 </listOfParameters>

```

Listing 2.3: *The definition of a parameter in SED-ML*

value

The [value](#) attribute of data type `double` is required for each [Parameter](#). Each [Parameter](#) has exactly one fixed [value](#).

2.1.6 Variable

A [Variable](#) (Figure 2.6 on the next page) is a reference to an already existing entity, either to an object in one of the [Models](#) or to implicitly defined [Symbols](#). The [Variable](#) class introduces the required attribute [id](#), the optional attribute [name](#), and the context dependent attributes [target](#), [symbol](#), [taskReference](#), and [modelReference](#).

If the variable is defined through a reference to a model constituent, such as an SBML species, or to an entity within the SED-ML file itself, then the reference is specified using the [target](#) attribute. If the variable is defined through a reference to a [Symbol](#), rather than one explicitly appearing in the model, then the [symbol](#) attribute is used.

- A [Variable](#) is always placed inside a [listOfVariables](#).
- The [symbol](#) and [target](#) attributes must not be used together in a single instance of [Variable](#), although at least one must be present.
- A [Variable](#) element must contain a [taskReference](#) if it occurs inside a [listOfVariables](#) inside a [dataGenerator](#) element. Only exception is if the [Variable](#) references a [DataSource](#), in this case no [taskReference](#) is required.

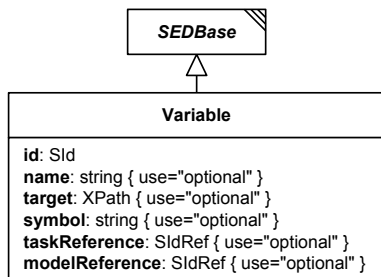

Figure 2.6: The Variable class

attribute	description
metaid ^o	page 12
id	page 17
name ^o	page 17
target	page 15
symbol	page 16
taskReference	page 19
modelReference	page 18
sub-elements	description
notes ^o	page 13
annotation ^o	page 13

Table 2.4: Attributes and nested elements for Variable. ^odenotes optional elements and attributes.

- A Variable element must contain a modelReference if it occurs inside a listOfVariables inside a computeChange element.
- A Variable element appearing within a functionalRange or setValue element must contain a modelReference if and only if it references a model variable.

Listing 2.4 shows the use of the variable element. In the example a variable v1 is defined to compute a change on a model constituent (referenced by the target attribute on computeChange). The value of v1 corresponds to the value of the targeted model constituent referenced by the target attribute. The second variable v2 is used inside a dataGenerator. As the variable is time as used in task1, the symbol attribute is used to refer to the SED-ML URI for time.

```

1 <sedML>
2   <listOfModels>
3     <model [...]>
4       <listOfChanges>
5         <computeChange target="TARGET ELEMENT OR ATTRIBUTE">
6           <listOfVariables>
7             <variable id="v1" name="maximum velocity" target="XPath TO MODEL ELEMENT/ATTRIBUTE" />
8             [FURTHER VARIABLE DEFINITIONS]
9           </listOfVariables>
10          [...]
11         </computeChange>
12       </listOfChanges>
13     </model>
14   </listOfModels>
15   <listOfDataGenerators>
16     <dataGenerator [...]>
17       <listOfVariables>
18         <variable id="v2" name="time" taskReference="task1" symbol="urn:sedml:symbol:time" />
19         [FURTHER VARIABLE DEFINITIONS]
20       </listOfVariables>
21     </dataGenerator>
22   </listOfDataGenerators>
23   [...]
24 </sedML>
  
```

Listing 2.4: SED-ML variable definitions inside the computeChange element and inside the dataGenerator element

target

An instance of Variable can refer to a model constituent inside a particular model through an XPath expression stored in the target attribute.

The target attribute may also be used to reference an entity within the SED-ML file itself, by containing a fragment identifier consisting of a hash character (#) followed by the SId of the targeted element. As of SED-ML Level 1 Version 3 this is used to refer to a DataSource in a Variable or to refer to ranges within a repeatedTask (see Listing 2.44).

Note that while it is possible to write XPath expressions that select multiple nodes within a referenced

model, when used within a **target** attribute a single element or attribute *must* be selected by the expression.

Listing 2.5 shows the use of the **target** attribute in a SED-ML file. In the example the **target** is used to reference a species with **id='PY'** in an SBML model.

```
1 <listOfVariables>
2   <variable id="v1" name="TetR protein" taskReference="task1"
3     target="/sbml:sbml/sbml:listOfSpecies/sbml:species[@id='PY']" />
4 </listOfVariables>
```

Listing 2.5: *SED-ML target definition*

It should be noted that the identifiers and names inside the SED-ML document do not have to match the identifiers and names that the model and its constituents have in the model definition. In Listing 2.5, the variable with ID **v1** is defined. It is described as **TetR protein**. The reference points to a species in the referenced SBML model. The particular species can be identified through its ID in the SBML model, namely **PY**. However, SED-ML also permits using identical identifiers and names as in the referenced models. The following Listing 2.6 is another valid example for the specification of a variable, but uses the same naming in the variable definition as in the original model (as opposed to Listing 2.5):

```
1 <listOfVariables>
2   <variable id="PY" name="TetR protein" taskReference="task1"
3     target="/sbml:sbml/sbml:listOfSpecies/sbml:species[@id='PY']" />
4 </listOfVariables>
```

Listing 2.6: *SED-ML variable definition using the original model identifier and name in SED-ML*

```
1 <sbml [...]>
2   <listOfSpecies>
3     <species metaid="PY" id="PY" name="TetR protein" [...]>
4       [...]
5     </species>
6   </listOfSpecies>
7   [...]
8 </sbml>
```

Listing 2.7: *Species definition in the referenced model*

The **XPath** expression used in the **target** attribute unambiguously leads to the particular place in the SBML model, i.e., the species is to be found in the *sbml* element, and there inside the *listOfSpecies* (Listing 2.7).

symbol

The **symbol** element is used to refer to a **Symbol**. **Symbols** are predefined, implicit variables, which can be used in a SED-ML file by referring to the defined URNs representing that variable's concept. The notion of implicit variables is explained in Section 3.2.5.

Listing 2.8 shows the use of the **symbol** attribute in a SED-ML file. The example encodes a computed change of model **m001**. To specify that change, a symbol is defined (i.e., the SED-ML symbol for **time** is assigned to the variable **t1**). How to compute the change itself is explained in Section 2.2.5.6.

```
1 <listOfVariables>
2   <variable id="t1" name="time" taskReference="task1" symbol="urn:sedml:symbol:time" />
3 </listOfVariables>
```

Listing 2.8: *SED-ML symbol definition*

taskReference

The **taskReference** element of data type **SIDRef** is used to reference a **Task** via a **taskReference**. The usage depends on the context the **Variable** is used in.

modelReference

The **modelReference** element of data type **SIDRef** is used to reference a **Model** via a **modelReference**. The usage depends on the context the **Variable** is used in.

2.1.7 General attributes

This section describes attributes which occur on multiple SED-ML classes, e.g., **id**, **name**, **math**, **kisaoID**, or **listOf*** constructs.

2.1.7.1 id

Most SED-ML classes have an **id** attribute of data type **SId**. The **id** attribute, if it exists for an object, is required and identifies SED-ML constituents unambiguously. All **ids** have a global scope, i.e., every **id** must be unambiguous throughout a SED-ML document.

An example for an **id** is given in Listing 2.9. In the example the model has the **id** **m00001**.

```
1 <model id="m00001" language="urn:sedml:language:sbml" source="urn:miriam:biomodels.db:BIOMD0000000012">
2   [MODEL DEFINITION]
3 </model>
```

Listing 2.9: SED-ML id definition, e.g., for a model

2.1.7.2 name

SED-ML classes may have an optional element **name** of data type **string**. Names do not have identifying character, i.e., several SED-ML constituents may have the same name. The purpose of the **name** attribute is to store a human-readable name.

Listing 2.10 extends the model definition in Listing 2.9 by a model **name**.

```
1 <model id="m00001" name="Circadian oscillator" language="urn:sedml:language:sbml" source="
   urn:miriam:biomodels.db:BIOMD0000000012">
2   [MODEL DEFINITION]
3 </model>
```

Listing 2.10: SED-ML name definition, e.g., for a model

2.1.7.3 math

Some classes have a mandatory element **math** of data type **MathML** to encode mathematical expressions. Examples are the **ComputeChange** for pre-processing of **Models** or **DataGenerator** for post-processing of **Task** results. The available subset of mathematical functions and elements which can be used in the **math** element are listed in Section **MathML**.

2.1.7.4 kisaoID

Some classes, e.g., **Algorithm** and **AlgorithmParameter**, have a mandatory element **kisaoID** which references a term from the **KISAO** ontology. The referenced term must be defined in the correct syntax, as defined by the regular expression **KISAO:[0-9]{7}**. The referenced **KISAO** term should define the simulation **Algorithm** or **AlgorithmParameter** as precisely as possible.

2.1.7.5 listOf* containers

SED-ML **listOf*** elements serve as containers for a collection of objects of the same type. For example, the **listOfModels** contains all **Model** objects of a SED-ML document. Lists do not carry any further semantics nor do they add additional attributes. They might, however, be annotated with **Notes** and **Annotations** as they are derived from **SEDBase**. All **listOf*** elements are optional in a SED-ML document (with exception of **listOfRanges** and **listOfSubTasks** in a **RepeatedTask**, which are mandatory).

2.1.7.6 listOfParameters

All **Parameters** needed throughout the simulation experiment, whether to compute a change on a model prior to or during simulation (**ComputeChange** and **SetValue**), to compute values in a **FunctionalRange**, or to set up a **DataGenerator**, are defined inside a **listOfParameters**.

Listing 2.11 shows the use of the **listOfParameters** element. The element is optional and may contain zero to many parameters.

```
1 <listOfParameters>
2   <parameter id="p1" value="1" />
3   <parameter id="p2" name="Kadp_2" value="0.23" />
4 </listOfParameters>
```

Listing 2.11: SED-ML listOfParameters element

2.1.7.7 listOfVariables

The **Variable** class is used to refer to existing entities inside a model. The container for all variables is **listOfVariables**. It includes all variables that need to be defined to either describe a change in the

model by means of mathematical equations via [ComputeChange](#) or to set up a [DataGenerator](#). The [listOfVariables](#) is optional and may contain zero to many variables.

Listing 2.12 shows the use of the `listOfVariables` element.

```

1 <listOfVariables>
2   <variable id="v1" name="maximum velocity" taskReference="task1"
3     target="/cellml:model/cellml:component[@cmeta:id='MP']/cellml:variable[@name='vsP']/
4     @initial_value" />
5   <variable id="v2" taskReference="task2" symbol="urn:sedml:symbol:time" />
6 </listOfVariables>

```

Listing 2.12: *SED-ML listOfVariables element*

2.1.8 Reference relations

The [reference](#) concept is used to refer to a particular element inside the SED-ML document. It may occur as an association between:

- two [Models](#) ([modelReference](#))
- a [Variable](#) and a [Model](#) ([modelReference](#))
- a [Variable](#) and an [AbstractTask](#) ([taskReference](#))
- a [Task](#) and the simulated [Model](#) ([modelReference](#))
- a [Task](#) and the [Simulation](#) ([simulationReference](#))
- an [Output](#) and a [DataGenerator](#) ([dataReference](#))

The definition of a [Task](#) requires a reference to a particular [Model](#) object ([modelReference](#)); furthermore, the [Task](#) object must be associated with a particular [Simulation](#) object ([simulationReference](#)).

Depending on the use of the [reference](#) relation in connection with a [Variable](#) object, it may take different roles:

- a. The [reference](#) association might occur between a [Variable](#) object and a [Model](#) object, e.g., if the variable is to define a [Change](#). In that case the `variable` element contains a [modelReference](#) to refer to the particular model that contains the variable used to define the change.
- b. If the [reference](#) is used as an association between a [Variable](#) object and an [AbstractTask](#) object inside the `dataGenerator` class, then the `variable` element contains a [taskReference](#) to unambiguously refer to an observable in a given task.

2.1.8.1 modelReference

The [modelReference](#) is a [reference](#) used to refer to a particular [Model](#) via a [SIdRef](#). The [modelReference](#) either represents a relation between two [Model](#) objects, a [Variable](#) object and a [Model](#) object, or a relation between a [Task](#) object and a [Model](#) object.

The `source` attribute of a [Model](#) is allowed to reference either a URI or an [SId](#) of a second [Model](#). Circular constructs where a model **A** refers to a model **B** and **B** to **A** (directly or indirectly) are invalid.

If pre-processing needs to be applied to a model before simulation, then the model update can be specified by creating a [Change](#) object. In the particular case that a change must be calculated with a mathematical function, variables need to be defined. To refer to an existing entity in a defined [Model](#), the [modelReference](#) is used.

The `modelReference` attribute of the `variable` element contains the `id` of a model that is defined in the document.

Listing 2.13 shows the use of the `modelReference` element. In the example, a change is applied on model `m0001`. In the `computeChange` element a list of variables is defined. One of those variable is `v1` which is defined in another model (`cellML`). The [XPath](#) expression given in the `target` attribute identifies the variable in the model which carries the ID `cellML`.

```

1 <model id="m0001" [...]>
2   <listOfChanges>
3     <computeChange>

```

```

4         <listOfVariables>
5           <variable id="v1" modelReference="cellML" target="/cellml:model/cellml:component[
6             @cmeta:id='MP']/cellml:variable[@name='vsP']/@initial_value" />
7           [...]
8         </listOfVariables>
9         <listOfParameters [...] />
10        <math>
11          [CALCULATION OF CHANGE]
12        </math>
13      </computeChange>
14    </listOfChanges>
15  </model>

```

Listing 2.13: *SED-ML modelReference attribute inside a variable definition of a computeChange element*

The `modelReference` is also used to indicate that a `Model` object is used in a particular `Task`. Listing 2.14 shows how this can be done for a sample SED-ML document.

```

1 <listOfTasks>
2   <task id="t1" name="Baseline" modelReference="model1" simulationReference="simulation1" />
3   <task id="t2" name="Modified" modelReference="model2" simulationReference="simulation1" />
4 </listOfTasks>

```

Listing 2.14: *SED-ML modelReference definition inside a task element*

The example defines two different tasks; the first one applies the simulation settings of `simulation1` on `model1`, the second one applies the same simulation settings on `model2`.

2.1.8.2 simulationReference

The `simulationReference` is used to refer to a particular `Simulation` via a `SIRef`, e.g., in a `Task`.

Listing 2.14 shows the reference to a defined simulation for a sample SED-ML document. In the example, both tasks `t1` and `t2` use the simulation settings defined in `simulation1` to run the experiment.

2.1.8.3 taskReference

The `taskReference` is a `reference` used to refer to a particular `AbstractTask` via a `SIRef`. The `taskReference` is used in `SubTask` to reference the respective subtask, or in `Variable` within a `DataGenerator`.

`DataGenerator` objects are created to apply post-processing to the simulation results before final output. For certain types of post-processing `Variable` objects need to be created. These link to a `task` defined within the `listOfTasks` from which the model that contains the variable of interest can be inferred. A `taskReference` association is used to realise that link from a `Variable` object inside a `DataGenerator` to an `AbstractTask` object. Listing 2.15 gives an example.

```

1 <listOfDataGenerators>
2   <dataGenerator id="tim3" name="tim mRNA (difference v1-v2+20)">
3     <listOfVariables>
4       <variable id="v1" taskReference="t1" [...] />
5     </listOfVariables>
6     <math [...] />
7   </dataGenerator>
8 </listOfDataGenerators>

```

Listing 2.15: *SED-ML taskReference definition inside a dataGenerator element*

The example shows the definition of a variable `v1` in a `dataGenerator` element. The variable appears in the model that is used in task `t1`. The task definition of `t1` might look as shown in Listing 2.16.

```

1 <listOfTasks>
2   <task id="t1" name="task definition" modelReference="model1" simulationReference="simulation1" />
3 </listOfTasks>

```

Listing 2.16: *Use of the reference relations in a task definition*

Task `t1` references the model `model1`. Therefore we can conclude that the variable `v1` defined in Listing 2.15 targets an element of the model with ID `model1`. The targeting process itself will be explained in section 2.1.6 on page 15.

2.1.8.4 dataReference

The `dataReference` is a `reference` used to refer to a particular `DataGenerator` via a `SIRef`, e.g., from an `Output` instance.

Four different types of `dataReference` exist in SED-ML Level 1 Version 3. They are used depending on the type of output for the simulation. A `Plot2D` has an `xDataReference` and a `yDataReference` assigned. A `Plot3D` has in addition a `zDataReference` assigned. To define a report, each data column has a `dataReference` assigned.

Listing 2.17 shows the reference to a defined data set for a sample SED-ML document. In the example, the output type is a 2D plot, which defines one curve with id `c1`. A curve must refer to two different data generators which describe how to procure the data that is to be plotted on the x-axis and y-axis respectively.

```
1 <listOfOutputs>
2   <plot2D id="p1" [...] >
3     <curve id="c1" xDataReference="dg1" yDataReference="dg2" />
4     [...]
5   </plot>
6 </listOfOutputs>
```

Listing 2.17: *Example for the use of data references in a curve definition*

2.2 SED-ML Components

In this section the major components of SED-ML are described. The complete UML class diagram is given in Figure 2.1 on page 10, example simulation experiments are provided in Appendix A, the XML Schema is listed in Appendix B.

2.2.1 SED-ML top level element

Each SED-ML Level 1 Version 3 document has a main class called **SED-ML** which defines the document's structure and content (Figure 2.7 on the following page). It consists of several parts connected to the **SED-ML** class via **listOf*** constructs:

- **DataDescription** (for specification of external data),
- **Model** (for specification of models),
- **Simulation** (for specification of simulation setups),
- **AbstractTask** (for the linkage of models and simulation setups),
- **DataGenerator** (for the definition of post-processing),
- **Output** (for the specification of plots and reports).

A SED-ML document needs to have the SED-ML namespace defined through the mandatory **xmlns** attribute. In addition, the SED-ML **level** and **version** attributes are required.

The root element of each SED-ML XML file is the **sedML** element, encoding **level** and **version** of the file, and setting the necessary namespaces. Nested inside the **sedML** element are the six optional lists serving as containers for the encoded information: **listOfDataDescriptions** for all external data, **listOfModels** for all models, **listOfSimulations** for all simulations, **listOfTasks** for all tasks, **listOfDataGenerators** for all post-processing definitions, and **listOfOutputs** for all output definitions.

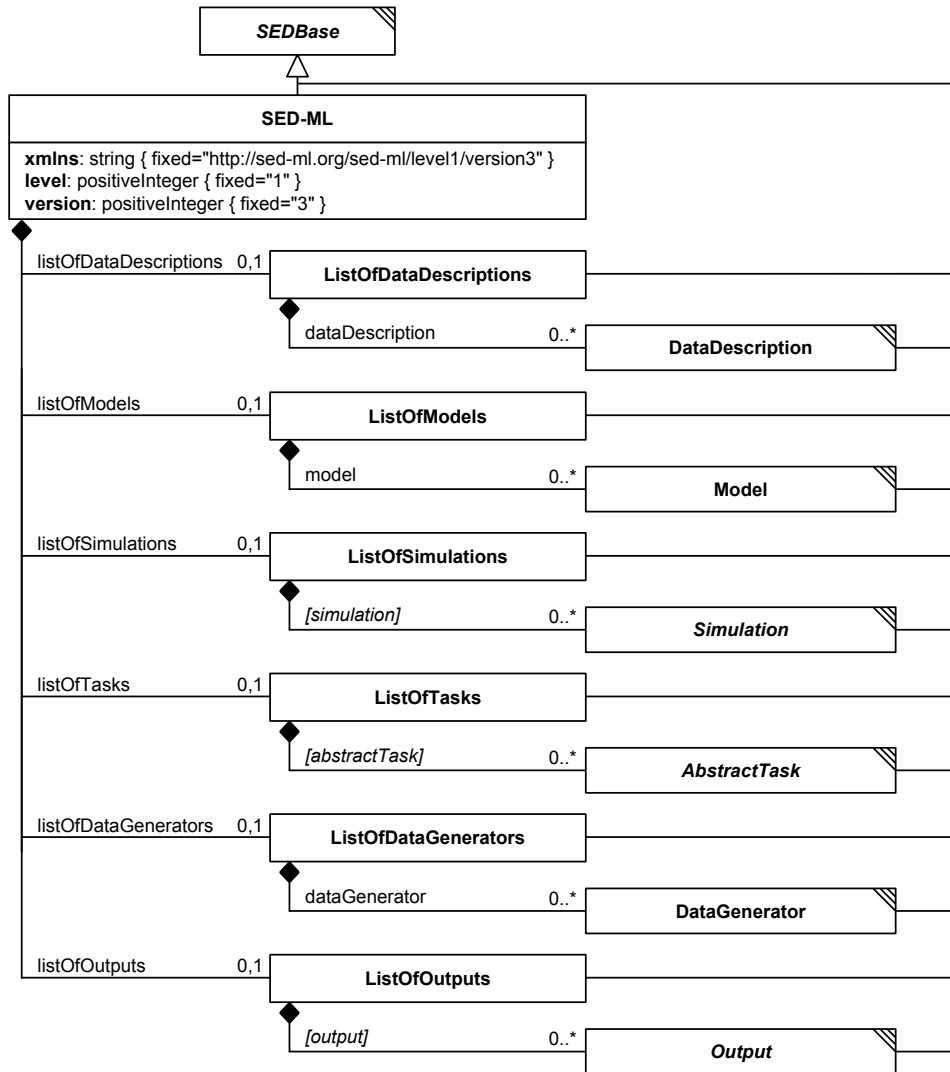

Figure 2.7: The SED-ML class

Table 2.5 shows all attributes and sub-elements for the SED-ML element.

attribute	description
metaid ^o	page 12
xmlns	page 23
level	page 23
version	page 23
sub-elements	description
notes ^o	page 13
annotation ^o	page 13
listOfDataDescriptions ^o	page 23
listOfModels ^o	page 24
listOfSimulations ^o	page 24
listOfTasks ^o	page 24
listOfDataGenerators ^o	page 24
listOfOutputs ^o	page 25

Table 2.5: Attributes and nested elements for SED-ML. ^odenotes optional elements and attributes.

The basic XML structure of a SED-ML file is shown in listing 2.18.

```

1 <?xml version="1.0" encoding="utf-8"?>
2 <sedML xmlns:math="http://www.w3.org/1998/Math/MathML"
3   xmlns="http://sed-ml.org/sed-ml/level1/version3" level="1" version="3">
4   <listOfDataDescriptions>
5     [DATA REFERENCES AND TRANSFORMATIONS]
6   </listOfDataDescriptions>
7   <listOfModels>
8     [MODEL REFERENCES AND APPLIED CHANGES]
9   </listOfModels>
10  <listOfSimulations>
11    [SIMULATION SETUPS]
12  </listOfSimulations>
13  <listOfTasks>
14    [MODELS LINKED TO SIMULATIONS]
15  </listOfTasks>
16  <listOfDataGenerators>
17    [DEFINITION OF POST-PROCESSING]
18  </listOfDataGenerators>
19  <listOfOutputs>
20    [DEFINITION OF OUTPUT]
21  </listOfOutputs>
22 </sedML>

```

Listing 2.18: *The SED-ML root element*

2.2.1.1 *xmlns*

The *xmlns* attribute declares the namespace for the SED-ML document. The pre-defined namespace for SED-ML documents is <http://sed-ml.org/sed-ml/level1/version3>.

In addition, SED-ML makes use of the *MathML* namespace <http://www.w3.org/1998/Math/MathML> to enable the encoding of mathematical expressions. SED-ML *notes* use the XHTML namespace <http://www.w3.org/1999/xhtml>. Additional external namespaces might be used in *annotations*.

2.2.1.2 *level*

The current SED-ML *level* is 1. Major revisions containing substantial changes will lead to the definition of forthcoming levels. The *level* attribute is required and its value is a fixed *decimal*. For SED-ML Level 1 Version 3 the value is set to 1, as shown in the example in Listing 2.18.

2.2.1.3 *version*

The current SED-ML *version* is 3. Minor revisions containing corrections and refinements of SED-ML elements, or new constructs which do not affect backwards compatibility, will lead to the definition of forthcoming versions.

The *version* attribute is required and its value is a fixed *decimal*. For SED-ML Level 1 Version 3 the value is set to 3, as shown in the example in Listing 2.18.

2.2.1.4 *listOfDataDescriptions*

In order to reference data in a simulation experiment, the data files along with a description on how to access such files and what information to extract from them have to be defined. The *SED-ML document* uses the *listOfDataDescriptions* container to define *DataDescriptions* for referencing external data (Figure 2.7 on the previous page). The *listOfDataDescriptions* is optional and may contain zero to many *DataDescriptions*.

Listing 2.19 shows the use of the *listOfDataDescriptions* element.

```

1 <listOfDataDescriptions>
2   <dataDescription id="Data1" name="Oscli Time Course Data" source="./oscli.numl">
3     <dimensionDescription>
4       <compositeDescription indexType="double" id="time" name="time" xmlns="http://www.numl.org/
5         numl/level1/version1">
6         <compositeDescription indexType="string" id="SpeciesIds" name="SpeciesIds">
7           <atomicDescription valueType="double" name="Concentrations" />
8         </compositeDescription>
9       </compositeDescription>
10    </dimensionDescription>
11    <listOfDataSources>
12      <dataSource id="dataS1">
13        <listOfSlices>
14          <slice reference="SpeciesIds" value="S1" />
15        </listOfSlices>
16      </dataSource>

```



```

16         <dataSource id="dataTime" indexSet="time" />
17     </listOfDataSources>
18     </dataDescription>
19 </listOfDataDescriptions>

```

Listing 2.19: *SED-ML listOfDataDescriptions element*

2.2.1.5 listOfModels

The models used in a simulation experiment are defined in the `listOfModels` container (Figure 2.7 on page 22). The `listOfModels` is optional and may contain zero to many `Models`. However, if a `SED-ML document` contains one or more `Tasks`, at least one `Model` must be defined to which the `Task` elements refer (see Section 2.1.8.1).

Listing 2.20 shows the use of the `listOfModels` element.

```

1 <listOfModels>
2   <model id="m0001" language="urn:sedml:language:sbml"
3     source="urn:miriam:biomodels.db:BIOMD0000000012" />
4   <model id="m0002" language="urn:sedml:language:cellml"
5     source="http://models.cellml.org/workspace/leloup_gonze_goldbeter_1999/@@rawfile/
6       d6613d7e1051b3eff2bb1d3d419a445bb8c754ad/leloup_gonze_goldbeter_1999_a.cellml" />
7 </listOfModels>

```

Listing 2.20: *SED-ML listOfModels element*

2.2.1.6 listOfSimulations

The `listOfSimulations` element is the container for `Simulation` descriptions (Figure 2.7 on page 22). The `listOfSimulations` is optional and may contain zero to many `Simulations`. However, if the `SED-ML document` contains one or more `Tasks`, at least one `Simulation` element must be defined to which the `Task` elements refer (see Section 2.1.8.2).

Listing 2.21 shows the use of the `listOfSimulation` element.

```

1 <listOfSimulations>
2   <simulation id="s1" [...]>
3     [UNIFORM TIMECOURSE DEFINITION]
4   </simulation>
5   <simulation id="s2" [...]>
6     [UNIFORM TIMECOURSE DEFINITION]
7   </simulation>
8 </listOfSimulations>

```

Listing 2.21: *The SED-ML listOfSimulations element, containing two simulation setups*

2.2.1.7 listOfTasks

The `listOfTasks` element contains the defined `tasks` for the simulation experiment (Figure 2.7 on page 22). The `listOfTasks` is optional and may contain zero to many tasks, each of which is an instance of a subclass of `AbstractTask`.

Listing 2.22 shows the use of the `listOfTasks` element.

```

1 <listOfTasks>
2   <task id="t1" name="simulating v1" modelReference="m1" simulationReference="s1">
3     [FURTHER TASK DEFINITIONS]
4 </listOfTasks>

```

Listing 2.22: *The SED-ML listOfTasks element, defining one task*

2.2.1.8 listOfDataGenerators

The `listOfDataGenerators` container holds the `dataGenerator` definitions of a simulation experiment (Figure 2.7 on page 22). The `listOfDataGenerators` is optional and in general may contain zero to many `DataGenerators`.

In SED-ML, all variable and parameter values used in the `Output` class need to be defined as a `DataGenerator` beforehand.

Listing 2.23 shows the use of the `listOfDataGenerators` element.

```

1 <listOfDataGenerators>
2   <dataGenerator id="d1" name="time">
3     [DATA GENERATOR DEFINITION FOLLOWING]

```

```

4   </dataGenerator>
5   <dataGenerator id="LaCI" name="LaCI repressor">
6     [DATA GENERATOR DEFINITION FOLLOWING]
7   </dataGenerator>
8 </listOfDataGenerators>

```

Listing 2.23: *The listOfDataGenerators element, defining two data generators time and LaCI repressor*

2.2.1.9 listOfOutputs

The `listOfOutputs` container holds the `Output` definitions of a simulation experiment (Figure 2.7 on page 22). The `listOfOutputs` is optional and may contain zero to many outputs.

Listing 2.24 shows the use of the `listOfOutputs` element.

```

1 <listOfOutputs>
2   <report id="report1">
3     [REPORT DEFINITION FOLLOWING]
4   </report>
5   <plot2D id="plot1">
6     [2D PLOT DEFINITION FOLLOWING]
7   </plot2D>
8 </listOfOutputs>

```

Listing 2.24: *The listOfOutput element*

2.2.2 DataDescription

The `DataDescription` class (Figure 2.8) allows to reference external data, and contains a description on how to access the data, in what format it is, and what subset of data to extract.

The `DataDescription` class introduces four attributes: the required attributes `id` and `source` and the optional attributes `format` and `name`. In addition two optional elements are defined: `dimensionDescription` and `listOfDataSources`.

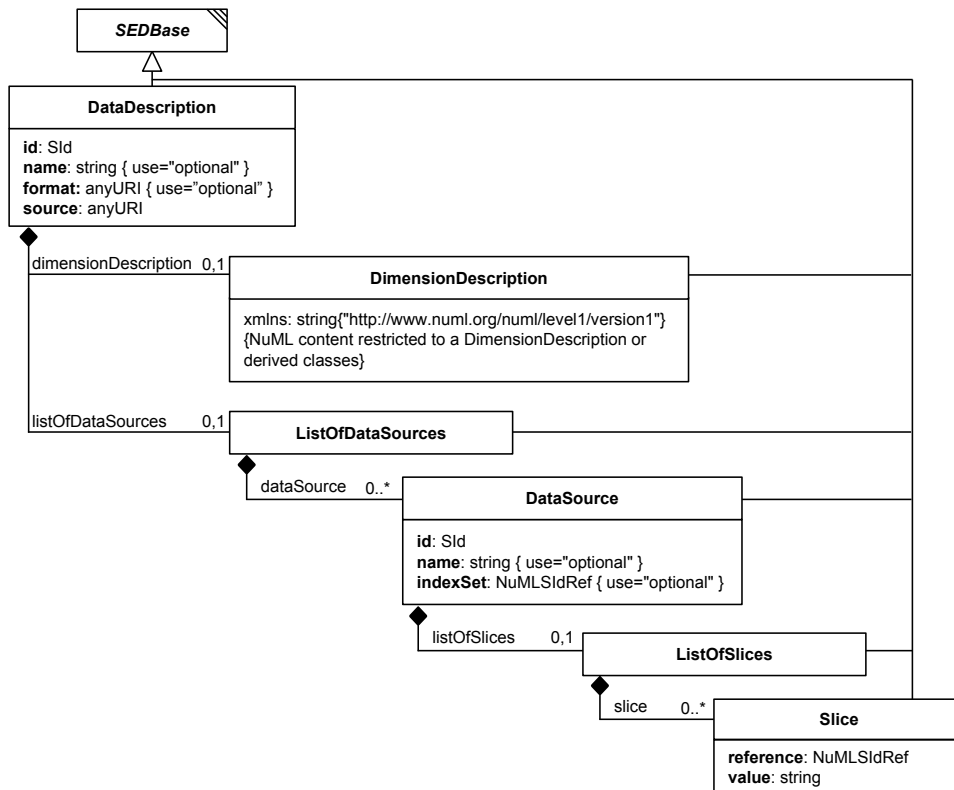

Figure 2.8: *The SED-ML DataDescription class*

Table 2.6 shows all attributes and sub-elements for the `dataDescription` element.

attribute	description
metaid ^o	page 12
id	page 17
name ^o	page 17
source	page 26
format ^o	page 26
sub-elements	description
notes ^o	page 13
annotation ^o	page 13
dimensionDescription ^o	page 26
listOfDataSources ^o	page 26

Table 2.6: *Attributes and nested elements for `dataDescription`. ^odenotes optional elements and attributes.*

Listing 2.25 shows the use of the `dataDescription` element.

```

1 <dataDescription id="Data1" name="Oscli Time Course Data" format="urn:sedml:format:numl"
2   source="http://svn.code.sf.net/p/libsedml/code/trunk/Samples/data/oscli.numl" >
3   [...]
4 </dataDescription>
```

Listing 2.25: *SED-ML `dataDescription` element*

source

The required `source` attribute of data type `anyURI` is used to specify the data file. The `source` attribute provides a location of a data file, analog to how the `source` attribute on the `Model` is handled. In order to resolve the `source` attribute, the same mechanisms are allowed as for the `Model source` element, i.e., via the local file system, a relative link, or an online resource.

format

The optional `format` attribute of data type `anyURI` is used to specify the format of the `DataDescription`. The allowed formats are defined in the `format references`, e.g., `NuML` (`urn:sedml:format:numl`) or `CSV` (`urn:sedml:format:csv`). If it is not explicitly defined the default value for `format` is `urn:sedml:format:numl`, referring to `NuML` representation of the data.

dimensionDescription

The optional `dimensionDescription` contains a `DimensionDescription` providing the dimension description of the data file. If the format is `NuML` (`urn:sedml:format:numl`) and a `dimensionDescription` is set, then the `dimensionDescription` must be identical to the `dimensionDescription` of the `NuML` file. If the format is not `NuML`, the `dimensionDescription` is required.

listOfDataSources

The optional `listOfDataSources` contains zero or more `DataSource` elements. A `DataSource` extracts chunks out of the external data provided by the outer `DataDescription` element.

2.2.3 DataDescription components

2.2.3.1 DimensionDescription

The `DimensionDescription` class (Figure 2.8 on the preceding page) defines the dimensions and data types of the external data provided by the outer `DataDescription` element. The `DimensionDescription` is a `NuML` container containing the dimension description of the dataset.

In the following example a nested `NuML compositeDescription` with `time` spanning one dimension and

SpeciesIds spanning a second dimension is given. This two dimensional space is then filled with double values representing concentrations.

```

1 <dimensionDescription>
2   <compositeDescription indexType="double" id="time" name="time"
3     xmlns="http://www.numl.org/numl/level1/version1">
4     <compositeDescription indexType="string" id="SpeciesIds" name="SpeciesIds">
5       <atomicDescription valueType="double" id="Concentration" name="Concentration" />
6     </compositeDescription>
7   </compositeDescription>
8 </dimensionDescription>

```

Listing 2.26: SED-ML dimensionDescription element

2.2.3.2 DataSource

The DataSource class (Figure 2.8 on page 25) extracts chunks out of the dataset provided by the outer DataDescription element. The DataSource class introduces three attributes: the required attribute id and the optional attributes name, indexSet, and listOfSlices (Figure 2.8 on page 25).

Table 2.7 shows all attributes and sub-elements for the dataSource element.

attribute	description
metaid ^o	page 12
id	page 17
name ^o	page 17
indexSet	page 28
sub-elements	description
notes ^o	page 13
annotation ^o	page 13
listOfSlices ^o	page 28

Table 2.7: Attributes and nested elements for dataSource. ^odenotes optional elements and attributes.

DataSource elements can be used anywhere in the SED-ML Description. Specifically their id attribute can be referenced within the listOfVariables of DataGenerator, ComputeChange or SetValue objects. Here an example that references the DataSource dataS1:

```

1 <listOfDataDescriptions>
2   <dataDescription id="data1" name="data file" source="./example.numl" format="urn:sedml:format:numl">
3     <dimensionDescription>
4       <compositeDescription indexType="double" name="Time">
5         <compositeDescription indexType="string" name="SpeciesIds">
6           <atomicDescription valueType="double" name="Values" />
7         </compositeDescription>
8       </compositeDescription>
9     </dimensionDescription>
10    <listOfDataSources>
11      <dataSource id="dataS1">
12        <listOfSlices>
13          <slice reference="SpeciesIds" value="S1" />
14        </listOfSlices>
15      </dataSource>
16      <dataSource id="dataTime" indexSet="Time" />
17    </listOfDataSources>
18  </dataDescription>
19 </listOfDataDescriptions>
20 <listOfDataGenerators>
21   <dataGenerator id="dgDataS1" name="S1 (data)">
22     <listOfVariables>
23       <variable id="varS1" modelReference="model1" target="#dataS1" />
24     </listOfVariables>
25     <math xmlns="http://www.w3.org/1998/Math/MathML">
26       <ci> varS1 </ci>
27     </math>
28   </dataGenerator>
29   ...
30 </listOfDataGenerators>

```

This represents a change from Level 1 Version 1 and Level 1 Version 2, in which a taskReference was always present for a variable in a DataGenerator.

To indicate that the `target` of the `Variable` is an entity defined within the current SED-ML description (and not an `Xpath` expression) the hashtag (`#`) with the reference to an `id` is used.

In addition, this example uses the `modelReference`, in order to facilitate a mapping of the data with a given model.

Data may contain NA values. All calculations containing a NA value have NA as a result.

Since data elements defined via the `DimensionDescription` of the `DataDescription` or within the NuML file are either values or indices, the `DataSource` element provides two ways of addressing those elements, the `indexSet` and `listOfSlices`.

`indexSet`

The `indexSet` attribute allows to address all indices provided by NuML elements with `indexType`.

For example for the `indexSet time` below, a `dataSource` extracts the set of all timepoints stored in the index.

```
1 <dataSource id="dataTime" indexSet="time" />
```

Similarly

```
1 <dataSource id="allIds" indexSet="SpeciesIds" />
```

extracts all the species id strings stored in that index set. Valid values for `indexSet` are all NuML Id elements declared in the `dimensionDescription`.

If the `indexSet` attribute is specified the corresponding `dataSource` may not define any `slice` elements.

`listOfSlices`

The `listOfSlices` contains one or more `Slice` elements. The `listOfSlices` container holds the `Slice` definitions of a `DataSource` (Figure 2.8 on page 25). The `listOfSlices` is optional and may contain zero to many `Slices`.

2.2.3.3 `Slice`

If a `DataSource` does not define the `indexSet` attribute, it will contain `Slice` elements. Each slice removes one dimension from the data hypercube.

The `Slice` class introduces two required attributes: `reference` and `value` (Figure 2.8 on page 25).

Table 2.8 shows all attributes and sub-elements for the `slice` element.

attribute	description
metaid ^o	page 12
reference	page 28
value	page 28
sub-elements	description
notes ^o	page 13
annotation ^o	page 13

Table 2.8: Attributes and nested elements for `slice`. ^odenotes optional elements and attributes.

`reference`

The `reference` attribute references one of the indices described in the `dimensionDescription`. In the example above, valid values would be: `time` and `SpeciesIds`.

`value`

The `value` attribute takes the value of a specific index in the referenced set of indices. For example:

```

1 <dataSource id="dataS1">
2   <listOfSlices>
3     <slice reference="SpeciesIds" value="S1" />
4   </listOfSlices>
5 </dataSource>

```

isolates the index set of all species ids specified to only the single entry for **S1**, however over the full range of the **time** index set. As stated before, there can be multiple slice elements present, so it is possible to slice the data again to obtain a single time point, for example the initial one:

```

1 <dataSource id="dataS1">
2   <listOfSlices>
3     <slice reference="time" value="0" />
4     <slice reference="SpeciesIds" value="S1" />
5   </listOfSlices>
6 </dataSource>

```

2.2.4 Model

The **Model** class defines the models used in a simulation experiment (Figure 2.9).

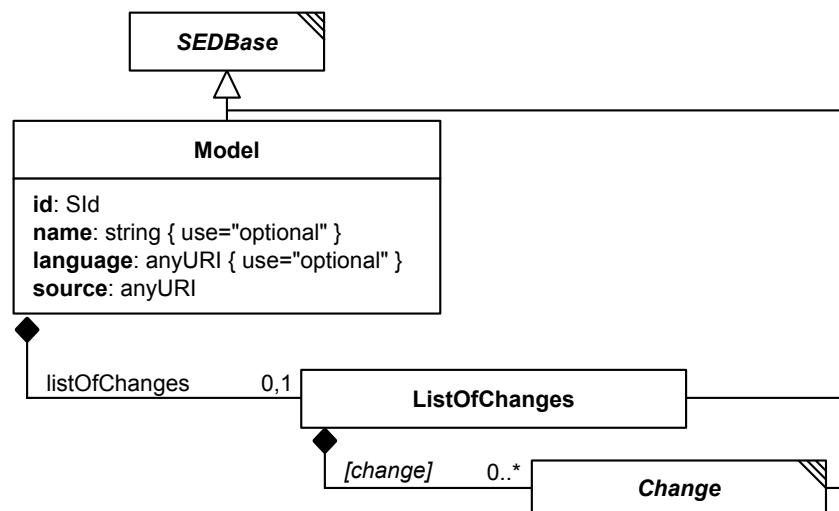

Figure 2.9: The SED-ML Model class

Each instance of the **Model** class has the mandatory attributes **id** and **source**, and the optional attributes **name**, **language**, and **listOfChanges**.

The optional attribute **language** defines the format the model is encoded in.

The **Model** class refers to the particular model of interest through the **source** attribute. The restrictions on the model reference are

- The model must be encoded in an XML format.
- To refer to the model encoding language, a reference to a valid definition of that XML format must be given (**language** attribute).
- To refer to a particular model in an external resource, an unambiguous reference must be given (**source** attribute).

A model might need to undergo pre-processing before simulation. Those pre-processing steps are specified in the **listOfChanges** via the **Change** class.

Table 2.9 on the following page shows all attributes and sub-elements for the **model** element.

Listing 2.27 on the next page shows the use of the **model** element. In the example the **listOfModels** contains three models: The first model **m0001** is the Repressilator model from BioModels Database

attribute	description
metaid ^o	page 12
id	page 17
name ^o	page 17
language ^o	page 30
source	page 30
sub-elements	description
notes ^o	page 13
annotation ^o	page 13
listOfChanges ^o	page 31

Table 2.9: Attributes and nested elements for *model*. ^odenotes optional elements and attributes.

available from [urn:miriam:biomodels.db:BIOMD0000000012](http://miriam.org/urn:miriam:biomodels.db:BIOMD0000000012). For the SED-ML simulation the model might undergo preprocessing steps described in the [listOfChanges](#). Based on the description of the first model [m0001](#), the second model [m00012](#) is built, which is a modified version of the Repressilator model. [m0002](#) refers to the model [m0001](#) in its [source](#) attribute. [m0002](#) might then have additional changes applied to it on top of the changes defined in the pre-processing of [m0001](#). The third model in the code example is a model in CellML representation. The model [m0003](#) is available from the given URL in the [source](#) attribute. Again, it might have pre-processing steps applied before used in a simulation.

```

1 <listOfModels>
2   <model id="m0001" language="urn:sedml:language:sbml"
3     source="urn:miriam:biomodels.db:BIOMD0000000012">
4     <listOfChanges>
5       <change>
6         [MODEL PRE-PROCESSING]
7       </change>
8     </listOfChanges>
9   </model>
10  <model id="m0002" language="urn:sedml:language:sbml" source="m0001">
11    <listOfChanges>
12      [MODEL PRE-PROCESSING]
13    </listOfChange>
14  </model>
15  <model id="m0003" language="urn:sedml:language:cellml" source="http://models.cellml.org/workspace/
16    leloup_gonze_goldbeter_1999/@rawfile/d6613d7e1051b3eff2bb1d3d419a445bb8c754ad/
17    leloup_gonze_goldbeter_1999_a.cellml">
18    [MODEL PRE-PROCESSING]
19  </model>
20 </listOfModels>

```

Listing 2.27: SED-ML model element

language

The optional [language](#) attribute of data type [anyURI](#) is used to specify the format of the [model](#). Example formats are SBML ([urn:sedml:language:sbml](#)) or CellML ([urn:sedml:language:cellml](#)). The supported languages are defined in the [language references](#).

If it is not explicitly defined the default value for [language](#) is [urn:sedml:language:xml](#), referring to any XML based model representation. However, the use of the [language](#) attribute is strongly encouraged for two reasons. Firstly, it helps to decide whether or not one is able to run the simulation, that is to parse the model referenced in the SED-ML file. Secondly, the [language](#) attribute is also needed to decide how to handle the [Symbols](#) in the [Variable](#) class, as the interpretation of [Symbols](#) depends on the language of the representation format.

source

To make a [model](#) accessible for the execution of a SED-ML file, the [source](#) must be specified through either an URI or a reference to an [SId](#) of an existing [Model](#). The URI should follow the proposed [URI Scheme](#) for [Model references](#).

An example for the definition of a model via an URI is given in [Listing 2.28](#). The example defines one model [m1](#) with the model [source](#) available from [urn:miriam:biomodels.db:BIOMD0000000012](http://miriam.org/urn:miriam:biomodels.db:BIOMD0000000012). The MIRIAM URN can be resolved into the SBML model stored in BioModels Database under the identi-

fier [BIOMD0000000012](https://www.ebi.ac.uk/biomodels-main/BIOMD0000000012) using the MIRIAM web service. The resulting URL is <https://www.ebi.ac.uk/biomodels-main/BIOMD0000000012>.

```
1 <model id="m1" name="repressilator" language="urn:sedml:language:sbml"
2   source="urn:miriam:biomodels.db:BIOMD0000000012">
3   <listOfChanges>
4     [MODEL PRE-PROCESSING]
5   </listOfChanges>
6 </model>
```

Listing 2.28: *The SED-ML source element, using the URI scheme*

An example for the definition of a model using an URL is given in Listing 2.29. In the example one model is defined. The `language` of the model is `CellML`. As the CellML model repository currently does not provide a MIRIAM URI for model reference, the `URL` pointing to the model is used in the `source` attribute.

```
1 <model id="m1" name="repressilator" language="urn:sedml:language:cellml"
2   source="http://models.cellml.org/exposure/bba4e39f2c7ba8af51fd045463e7bdd3/aguda_b_1999.cellml">
3   <listOfChanges />
4 </model>
```

Listing 2.29: *The SED-ML source element, using a URL*

`listOfChanges`

The `listOfChanges` (Figure 2.9 on page 29) contains the `Changes` to be applied to a particular `Model`. The `listOfChanges` is optional and may contain zero to many `Changes`.

Listing 2.30 shows the use of the `listOfChanges` element.

```
1 <model id="m0001" [...]>
2   <listOfChanges>
3     [CHANGE DEFINITION]
4   </listOfChanges>
5 </model>
```

Listing 2.30: *The SED-ML listOfChanges element, defining a change on a model*

2.2.5 Change

The `Change` class allows to describe changes applied to a `model` before simulation (Figure 2.10 on the following page). `Changes` can be of the following types:

- Changes on attributes of the model's XML representation (`ChangeAttribute`)
- Changes on any XML snippet of the model's XML representation (`AddXML`, `ChangeXML`, `RemoveXML`)
- Changes based on mathematical calculations (`ComputeChange`)

The `Change` class is abstract and serves as the base class for different types of changes, the `ChangeAttribute`, `AddXML`, `ChangeXML`, `RemoveXML`, and `ComputeChange`.

The `Change` class has the mandatory attribute `target` which defines the target of the change. The `target` attribute holds a valid `XPath` expression pointing to the XML element or XML attribute that is to undergo the defined changes. Except for the cases of `ChangeXML` and `RemoveXML`, this `XPath` expression must always select a single element or attribute within the relevant model.

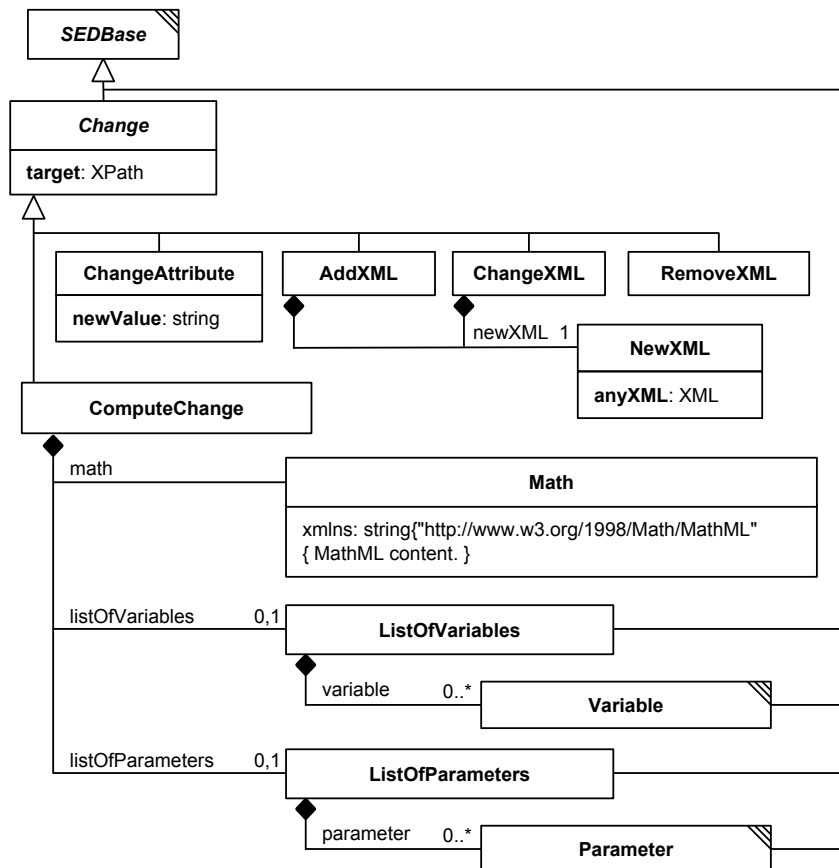

Figure 2.10: The SED-ML Change class

Table 2.10 shows all attributes and sub-elements for the `change` element.

attribute	description
metaid ^o	page 12
name ^o	page 17
target	page 32
sub-elements	description
notes ^o	page 13
annotation ^o	page 13

Table 2.10: Attributes and nested elements for `change`. ^o denotes optional elements and attributes.

target

The `target` attribute holds a valid `XPath` expression of data type `xpath` pointing to the XML element or XML attribute that is to undergo the defined changes.

2.2.5.1 NewXML

The `newXML` element provides a piece of XML code (Figure 2.10). `NewXML` must hold a valid piece of XML which after insertion into the original model must result in a valid model file (according to the model language specification as given by the `language` attribute of the `model`).

The `newXML` element is used at two different places inside SED-ML Level 1 Version 3:

1. If it is used as a sub-element of the `addXML` element, then the XML it contains *is inserted as a child*

of the XML element addressed by the XPath.

2. If it is used as a sub-element of the `changeXML` element, then the XML it contains *replaces* the XML element addressed by the XPath.

Examples are given in the relevant change class definitions.

2.2.5.2 AddXML

The `AddXML` class specifies a snippet of XML that is added as a child of the element selected by the XPath expression in the `target` attribute (Figure 2.10 on the previous page). The new piece of XML code is provided by the `NewXML` class.

An example for a change that adds an additional parameter to a model is given in Listing 2.31. In the example the model is changed so that a parameter with ID `V_mT` is added to its list of parameters. The `newXML` element adds an additional XML element to the original model. The element's name is `parameter` and it is added to the existing parent element `listOfParameters` that is addressed by the XPath expression in the `target` attribute.

```
1 <model language="urn:sedml:language:sbml" [..]>
2   <listOfChanges>
3     <addXML target="/sbml:sbml/sbml:model/sbml:listOfParameters" >
4       <newXML>
5         <parameter metaid="metaid_0000010" id="V_mT" value="0.7" />
6       </newXML>
7     </addXML>
8   </listOfChanges>
9 </model>
```

Listing 2.31: The `addXML` element with its `newXML` sub-element

2.2.5.3 ChangeXML

The `ChangeXML` class allows you to replace any XML element(s) in the model that can be addressed by a valid XPath expression (Figure 2.10 on the preceding page).

The XPath expression is specified in the required `target` attribute. The replacement XML content is specified in the `NewXML` class.

An example for a change that adds an additional parameter to a model is given in Listing 2.32. In the example the model is changed in the way that its parameter with ID `V_mT` is substituted by two other parameters `V_mT_1` and `V_mT_2`. The `target` attribute defines that the parameter with ID `V_mT` is to be changed. The `newXML` element then specifies the XML that is to be exchanged for that parameter.

```
1 <model [..]>
2   <listOfChanges>
3     <changeXML target="/sbml:sbml/sbml:model/sbml:listOfParameters/sbml:parameter[@id='V_mT']" >
4       <newXML>
5         <parameter metaid="metaid_0000010" id="V_mT_1" value="0.7" />
6         <parameter metaid="metaid_0000050" id="V_mT_2" value="4.6" />
7       </newXML>
8     </changeXML>
9   </listOfChanges>
10 </model>
```

Listing 2.32: The `changeXML` element

2.2.5.4 RemoveXML

The `RemoveXML` class can be used to delete XML elements or attributes in the model that are addressed by the XPath expression (Figure 2.10 on the previous page). The XPath is specified in the required `target` attribute.

An example for the removal of an XML element from a model is given in Listing 2.33. In the example the model is changed by deleting the reaction with ID `V_mT` from the model's list of reactions.

```
1 <model [..]>
2   <listOfChanges>
3     <removeXML target="/sbml:sbml/sbml:model/sbml:listOfReactions/sbml:reaction[@id='J1']" />
4   </listOfChanges>
5 </model>
```

Listing 2.33: The `removeXML` element

2.2.5.5 ChangeAttribute

The `ChangeAttribute` class allows to define updates on the XML attribute values of the corresponding model (Figure 2.10 on page 32). `ChangeAttribute` requires to specify the `target` of the change, i.e., the location of the addressed XML attribute, and also the `newValue` of that attribute. Note that the XPath expression in the `target` attribute must select a single attribute within the corresponding model.

The `ChangeXML` class covers the possibilities provided by the `ChangeAttribute` class, i.e., everything that can be expressed by a `ChangeAttribute` construct can also be expressed by `ChangeXML`. However, for the common case of changing an attribute value `ChangeAttribute` is easier to use, and so it is recommended to use the `ChangeAttribute` for any changes of an XML attribute's value, and to use the more general `ChangeXML` for other cases.

Table 2.11 shows all attributes and sub-elements for the `changeAttribute` element.

attribute	description
metaid ^o	page 12
name ^o	page 17
target	page 32
newValue	page 34
sub-elements	description
notes ^o	page 13
annotation ^o	page 13

Table 2.11: Attributes and nested elements for `ChangeAttribute`. ^odenotes optional elements and attributes.

newValue

The mandatory `newValue` attribute of data type `string` assigns a new value to the targeted XML attribute.

The example in Listing 2.34 shows the update of the value of two parameters inside an SBML model.

```
1 <model id="model1" name="Circadian Chaos" language="urn:sedml:language:sbml"
2   source="urn:miriam:biomodels.db:BIOMD0000000021">
3   <listOfChanges>
4     <changeAttribute target="/sbml:sbml/sbml:model/sbml:listOfParameters/sbml:parameter[@id='V_mT']/"
5       @value" newValue="0.28"/>
6     <changeAttribute target="/sbml:sbml/sbml:model/sbml:listOfParameters/sbml:parameter[@id='V_dT']/"
7       @value" newValue="4.8"/>
8   </listOfChanges>
9 </model>
```

Listing 2.34: The `changeAttribute` element and its `newValue` attribute

2.2.5.6 ComputeChange

The `ComputeChange` class permits to change, prior to the experiment, the numerical value of any element or attribute of a `Model` addressable by an XPath expression, based on a calculation (Figure 2.10 on page 32).

The mathematical expression for the change is specified using the required `math` attribute of data type `MathML`. If used as an element of the `ComputeChange` class, it computes the change of the element or attribute addressed by the `target` attribute.

The computation can use the value of `Variables` via the optional element `listOfVariables`. Those `variables` can then be addressed by their respective `id`. A `Variable` used in a `ComputeChange` must carry a `modelReference` attribute but no `taskReference` attribute (Figure 2.10 on page 32). If the variable is referring to a `DataSource` neither the `modelReference` nor `taskReference` is required.

Additional `Parameters` via the optional element `listOfParameters`. Such `Parameters` are thereafter referred to by their `id`.

Note that when a `ComputeChange` refers to another model, that model is not allowed to be modified by

`ComputeChanges` which directly or indirectly refer to this model. In other words, cycles in the definitions of computed changes are prohibited.

Table 2.12 shows all attributes and sub-elements for the `computeChange` element.

attribute	description
metaid ^o	page 12
name ^o	page 17
target	page 32
sub-elements	description
notes ^o	page 13
annotation ^o	page 13
listOfVariables ^o	page 17
listOfParameters ^o	page 17
math	page 17

Table 2.12: Attributes and nested elements for `computeChange`. ^odenotes optional elements and attributes.

Listing 2.35 shows the use of the `computeChange` element.

```

1 <model [...]
2   <listOfChanges>
3     <computeChange target="/sbml:sbml/sbml:model/sbml:listOfParameters/sbml:parameter[@id='sensor']">
4       <listOfVariables>
5         <variable modelReference="model1" id="R" name="regulator"
6           target="/sbml:sbml/sbml:model/sbml:listOfSpecies/sbml:species[@id='regulator']" />
7         <variable modelReference="model2" id="S" name="sensor"
8           target="/sbml:sbml/sbml:model/sbml:listOfParameters/sbml:parameter[@id='sensor']" />
9       </listOfVariables>
10      <listOfParameters>
11        <parameter id="n" name="cooperativity" value="2">
12          <parameter id="K" name="sensitivity" value="1e-6">
13        </listOfParameters>
14        <math xmlns="http://www.w3.org/1998/Math/MathML">
15          <apply>
16            <times />
17            <ci>S</ci>
18            <apply>
19              <divide />
20                <apply>
21                  <power />
22                    <ci>R</ci>
23                    <ci>n</ci>
24                </apply>
25              <apply>
26                <plus />
27                  <apply>
28                    <power />
29                      <ci>K</ci>
30                      <ci>n</ci>
31                  </apply>
32                <apply>
33                  <power />
34                    <ci>R</ci>
35                    <ci>n</ci>
36                </apply>
37              </apply>
38            </apply>
39          </math>
40        </computeChange>
41      </listOfChanges>
42 </model>

```

Listing 2.35: The `computeChange` element

The example in Listing 2.35 computes a change of the variable `sensor` of the model `model2`. To do so, it uses the value of the variable `regulator` coming from model `model1`. In addition, the calculation uses two additional parameters, the cooperativity `n`, and the sensitivity `K`. The mathematical expression in the mathML then computes the new initial value of `sensor` using the equation: $S = S \times \frac{R^n}{K^n + R^n}$

2.2.6 Simulation

A simulation is the execution of some defined algorithm(s). Simulations are described differently depending on the type of simulation experiment to be performed (Figure 2.11).

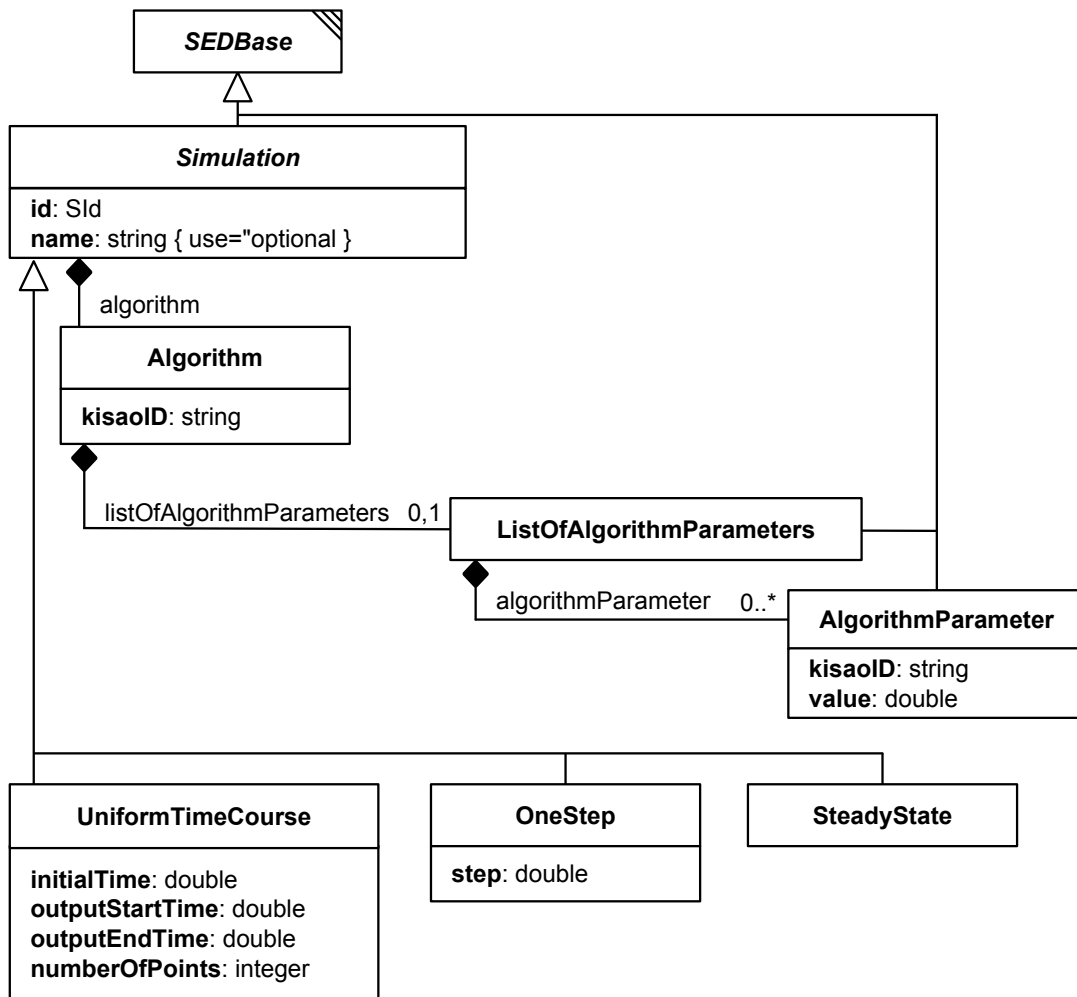

Figure 2.11: The SED-ML Simulation class

Simulation is an abstract class and serves as the container for the different types of simulation experiments. SED-ML Level 1 Version 3 provides the predefined simulation classes **UniformTimeCourse**, **OneStep** and **SteadyState**.

Each instance of the **Simulation** class has an unambiguous and mandatory **id**. An additional, optional **name** may be given to the simulation. Every simulation has a required element **algorithm** describing the simulation **Algorithm**.

Table 2.13 on the next page shows all attributes and sub-elements for the **simulation** element.

Listing 2.36 shows the use of the **simulation** element.

```

1 <listOfSimulations>
2   <uniformTimeCourse [...]>
3     [SIMULATION SPECIFICATION]
4   </uniformTimeCourse>
5   <uniformTimeCourse [...]>
6     [SIMULATION SPECIFICATION]
7   </uniformTimeCourse>
8 </listOfSimulations>
  
```

Listing 2.36: The SED-ML **listOfSimulations** element, defining two different **UniformTimecourse** simulations

attribute	description
metaid ^o	page 12
id	page 17
name ^o	page 17
sub-elements	description
notes ^o	page 13
annotation ^o	page 13
algorithm	page 39

Table 2.13: Attributes and nested elements for *simulation*. ^o denotes optional elements and attributes.

algorithm

The mandatory attribute `algorithm` defines the simulation algorithms used for the execution of the *simulation*. The algorithms are defined via the `Algorithm` class.

2.2.6.1 *UniformTimeCourse*

Each instance of the `UniformTimeCourse` class has, in addition to the elements from `Simulation`, the mandatory elements `initialTime`, `outputStartTime`, `outputEndTime`, and `numberOfPoints` (Figure 2.11 on the previous page).

Table 2.14 shows all attributes and sub-elements for the `uniformTimeCourse` element.

attribute	description
metaid ^o	page 12
id	page 17
name ^o	page 17
initialTime	page 37
outputStartTime	page 38
outputEndTime	page 38
numberOfPoints	page 38
sub-elements	description
notes ^o	page 13
annotation ^o	page 13
algorithm	page 39

Table 2.14: Attributes and nested elements for *uniformTimeCourse*. ^o denotes optional elements and attributes.

Listing 2.37 shows the use of the `uniformTimeCourse` element.

```

1 <listOfSimulations>
2   <uniformTimeCourse id="s1" name="time course simulation of variable v1 over 100 minutes"
3     initialTime="0" outputStartTime="0" outputEndTime="2500" numberOfPoints="1000">
4     <algorithm [...] />
5   </uniformTimeCourse>
6 </listOfSimulations>
```

Listing 2.37: The SED-ML `uniformTimeCourse` element, defining a uniform time course simulation over 2500 time units with 1000 simulation points.

initialTime

The attribute `initialTime` of type `double` represents what the time is at the start of the simulation, for purposes of output variables, and for calculating the `outputStartTime` and `outputEndTime`. In most cases, this will be `0.0`. The model must be set up such that `initialTime` is correct internally with respect to any output variables that may be produced. Listing 2.37 shows an example.

outputStartTime

Sometimes a researcher is not interested in simulation results at the start of the simulation, i.e., the initial time. The `UniformTimeCourse` class uses the attribute `outputStartTime` of type `double`, and describes the time (relative to the `initialTime`) that output is to be collected. To be valid the `outputStartTime` cannot be before `initialTime`. For an example, see Listing 2.37.

outputEndTime

The attribute `outputEndTime` of type `double` marks the end time of the simulation, relative to the `initialTime`. See Listing 2.37 for an example.

numberOfPoints

When executed, the `UniformTimeCourse` simulation produces an output on a regular grid starting with `outputStartTime` and ending with `outputEndTime`. The attribute `numberOfPoints` of type `integer` describes the number of points expected in the result. Software interpreting the `UniformTimeCourse` is expected to produce a first outputPoint at time `outputStartTime` and then `numberOfPoints` output points with the results of the simulation. Thus a total of `numberOfPoints + 1` output points will be produced.

Just because the output points lie on the regular grid described above, does not mean that the simulation algorithm has to work with the same step size. Usually the step size the simulator chooses will be adaptive and much smaller than the required output step size. On the other hand a stochastic simulator might not have any new events occurring between two grid points. Nevertheless the simulator has to produce data on this regular grid. For an example, see Listing 2.37.

2.2.6.2 OneStep

The `OneStep` class calculates one further output step for the model from its current state. Each instance of the `OneStep` class has, in addition to the elements from `Simulation`, the mandatory element `step` (Figure 2.11 on page 36).

Table 2.15 shows all attributes and sub-elements for the `oneStep` element.

attribute	description
metaid ^o	page 12
id	page 17
name ^o	page 17
step	page 38
sub-elements	description
notes ^o	page 13
annotation ^o	page 13
algorithm	page 39

Table 2.15: Attributes and nested elements for `oneStep`. ^o denotes optional elements and attributes.

Listing 2.38 shows the use of the `oneStep` element.

```
1 <listOfSimulations>
2   <oneStep id="s1" step="0.1">
3     <algorithm kisaID="KISA0:0000019" />
4   </oneStep>
5 </listOfSimulations>
```

Listing 2.38: The `SED-ML oneStep` element, specifying to apply the simulation algorithm for another output step of size 0.1.

step

The `OneStep` class has one required attribute `step` of type `double`. It defines the next output point that should be reached by the algorithm, by specifying the increment from the current output point.

Listing 2.38 shows an example.

Note that the `step` does not necessarily equate to one integration step. The simulator is allowed to take as many steps as needed. However, after running `oneStep`, the desired output time is reached.

2.2.6.3 SteadyState

The `SteadyState` represents a steady state computation (as for example implemented by NLEQ or Kin-solve). The `SteadyState` class has no additional elements than the elements from `Simulation` (Figure 2.11 on page 36).

Table 2.16 shows all attributes and sub-elements for the `steadyState` element.

attribute	description
metaid ^o	page 12
id	page 17
name ^o	page 17
sub-elements	description
notes ^o	page 13
annotation ^o	page 13
algorithm	page 39

Table 2.16: Attributes and nested elements for `steadyState`. ^odenotes optional elements and attributes.

Listing 2.39 shows the use of the `steadyState` element.

```

1 <listOfSimulations>
2   <steadyState id="steady">
3     <algorithm kisaoID="KISAO:0000282" />
4   </steadyState >
5 </listOfSimulations>

```

Listing 2.39: The SED-ML `steadyState` element, defining a steady state simulation with id `steady`.

2.2.7 Simulation components

2.2.7.1 Algorithm

The `Algorithm` class has a mandatory element `kisaoID` which contains a `KiSAO` reference to the particular simulation algorithm used in the `simulation`. In addition, the `Algorithm` has an optional `listOfAlgorithmParameters`, a collection of `algorithmParameter`, which are used to parameterize the `algorithm`.

Table 2.17 shows all attributes and sub-elements for the `Algorithm` element.

attribute	description
metaid ^o	page 12
kisaoID	page 61
sub-elements	description
notes ^o	page 13
annotation ^o	page 13
listOfAlgorithmParameters ^o	page 40

Table 2.17: Attributes and nested elements for `algorithm`. ^odenotes optional elements and attributes.

The example given in Listing 2.36, completed by algorithm definitions results in the code given in Listing 2.40. In the example, for both simulations a algorithm is defined. In the first simulation `s1` a deterministic approach is used (Euler forward method), in the second simulation `s2` a stochastic approach

is used (Stochsim nearest neighbor).

```
1 <listOfSimulations>
2   <uniformTimeCourse id="s1" name="time course simulation over 100 minutes" [...]>
3     <algorithm kisaoID="KISAO:0000030" />
4   </uniformTimeCourse>
5   <uniformTimeCourse id="s2" name="time course definition for concentration of p" [...]>
6     <algorithm kisaoID="KISAO:0000021" />
7   </uniformTimeCourse>
8 </listOfSimulations>
```

Listing 2.40: The SED-ML `algorithm` element for two different time course simulations, defining two different algorithms. `KISAO:0000030` refers to the Euler forward method ; `KISAO:0000021` refers to the StochSim nearest neighbor algorithm.

`listOfAlgorithmParameters`

The `listOfAlgorithmParameters` contains the settings for the simulation algorithm used in a `simulation` (Figure 2.11 on page 36). It may list several instances of the `AlgorithmParameter` class. The `listOfAlgorithmParameters` is optional and may contain zero to many parameters.

Listing 2.41 shows the use of the `listOfAlgorithmParameters` element.

```
1 <listOfAlgorithmParameters>
2   <algorithmParameter kisaoID="KISAO:0000211" value="23"/>
3 </listOfAlgorithmParameters>
```

Listing 2.41: SED-ML `listOfAlgorithmParameters` element

2.2.7.2 `AlgorithmParameter`

The `AlgorithmParameter` class allows to parameterize a particular simulation `algorithm`. The set of possible parameters for a particular instance is determined by the algorithm that is referenced by the `kisaoID` of the enclosing `algorithm` element (Figure 2.11 on page 36). Parameters of simulation algorithms are unambiguously referenced by the mandatory `kisaoID` attribute. Their value is set in the mandatory `value` attribute.

```
1 <algorithm kisaoID="KISAO:0000032">
2   <listOfAlgorithmParameters>
3     <algorithmParameter kisaoID="KISAO:0000211" value="23"/>
4   </listOfAlgorithmParameters>
5 </algorithm>
```

Listing 2.42: The SED-ML `algorithmParameter` element setting the parameter value for the simulation algorithm. `KISAO:0000032` refers to the explicit fourth-order Runge-Kutta method; `KISAO:00000211` refers to the absolute tolerance.

`value`

The `value` sets the value of the `AlgorithmParameter`.

2.2.8 `AbstractTask`

In SED-ML the subclasses of `AbstractTask` define which `Simulations` should be executed with which `Models` in the simulation experiment. `AbstractTask` is the base class of all SED-ML tasks, i.e. `Task` and `RepeatedTask`.

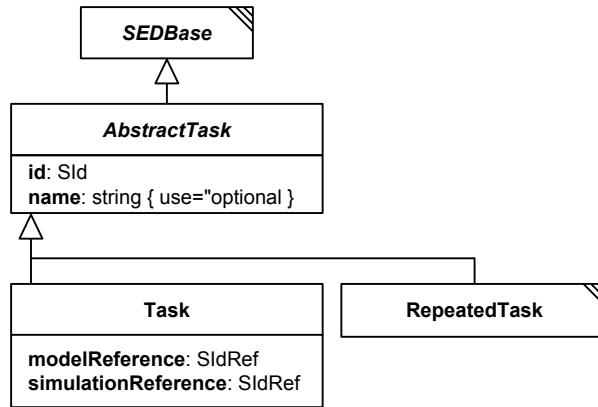

Figure 2.12: The SED-ML Abstract Task class

Table 2.18 shows all attributes and sub-elements for the `abstractTask` element.

attribute	description
metaid ^o	page 12
id	page 17
name ^o	page 17
sub-elements	description
notes ^o	page 13
annotation ^o	page 13

Table 2.18: Attributes and nested elements for `abstractTask`. ^odenotes optional elements and attributes.

2.2.8.1 Task

A `Task` links a `Model` to a certain `Simulation` description via their respective identifiers (Figure 2.12), using the `modelReference` and the `simulationReference`. The task class receives the `id` and `name` attributes from `AbstractTask`.

In SED-ML it is only possible to link one `Simulation` description to one `Model` at a time. However, one can define as many tasks as needed within one experiment description. Please note that the tasks may be executed in any order, as determined by the implementation.

Table 2.19 shows all attributes and sub-elements for the `task` element.

attribute	description
metaid ^o	page 12
id	page 17
name ^o	page 17
modelReference	page 18
simulationReference	page 19
sub-elements	description
notes ^o	page 13
annotation ^o	page 13

Table 2.19: Attributes and nested elements for `task`. ^odenotes optional elements and attributes.

Listing 2.43 on the next page shows the use of the `task` element. In the example, a simulation setting

simulation1 is applied first to model1 and then to model2.

```

1 <listOfTasks>
2   <task id="t1" name="task definition" modelReference="model1"
3     simulationReference="simulation1" />
4   <task id="t2" name="another task definition" modelReference="model2"
5     simulationReference="simulation1" />
6 </listOfTasks>

```

Listing 2.43: The task element

2.2.8.2 Repeated Task

The [RepeatedTask](#) (Figure 2.13) provides a generic looping construct, allowing complex tasks to be composed from individual steps. The [RepeatedTask](#) performs a specified task (or sequence of tasks as defined in the [listOfSubTasks](#)) multiple times (where the exact number is specified through a [Range](#) construct as defined in [range](#)), while allowing specific quantities in the model to be altered at each iteration (as defined in the [listOfChanges](#)).

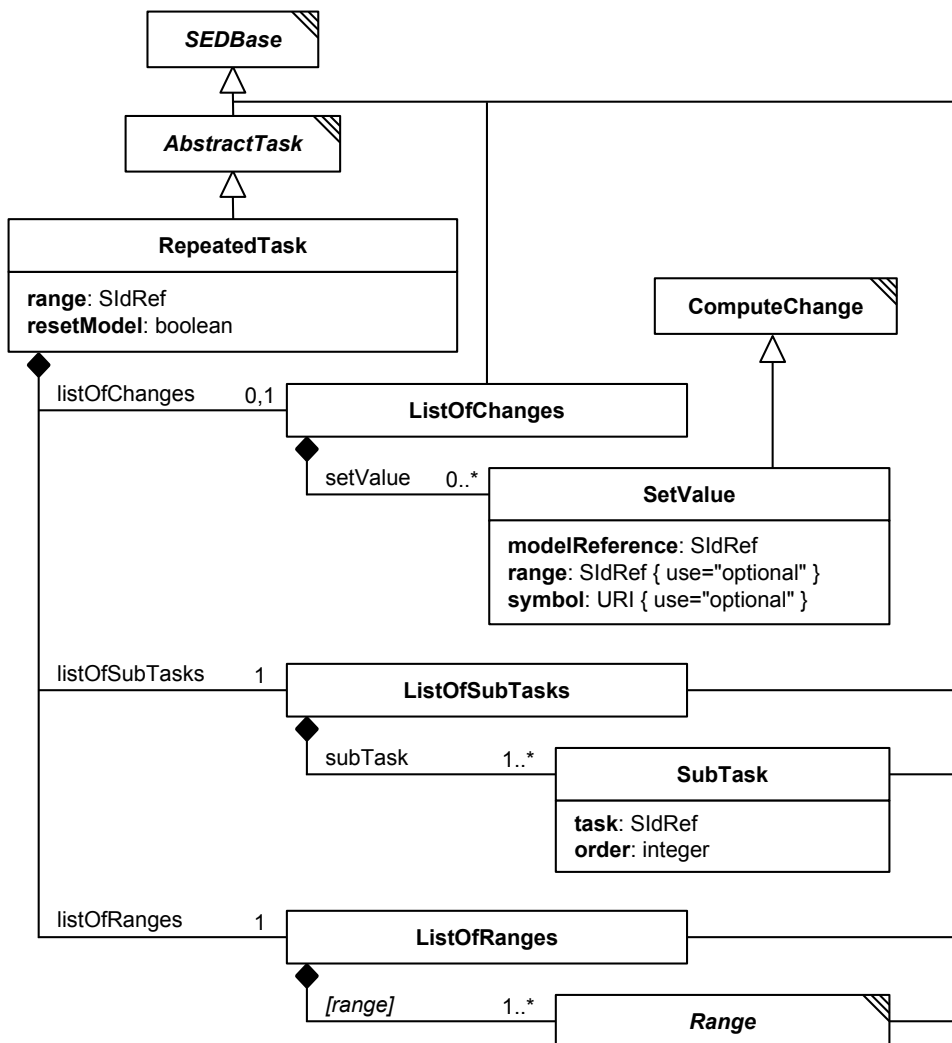

Figure 2.13: The SED-ML RepeatedTask class

The [RepeatedTask](#) inherits the required attribute [id](#) and optional attribute [name](#) from [AbstractTask](#). Additionally it has the two required attributes [range](#) and [resetModel](#) and the child elements [listOfRanges](#), [listOfChanges](#) and [listOfSubTasks](#). Of these [listOf*](#) only [listOfChanges](#) is optional.

The order of activities within each iteration of a [RepeatedTask](#) is as follows:

- The `Model` is reset if specified by the `resetModel` attribute.
- Any changes to the model specified by `SetValue` objects in the `listOfChanges` are applied to the `Model`.
- Finally, all `subTasks` in the `listOfSubtasks` are executed in the order specified by their `order` element.

Table 2.20 shows all attributes and sub-elements for the `repeatedTask` element.

attribute	description
<code>metaid</code> ^o	page 12
<code>id</code>	page 17
<code>name</code> ^o	page 17
<code>range</code>	page 43
<code>resetModel</code>	page 44
sub-elements	description
<code>notes</code> ^o	page 13
<code>annotation</code> ^o	page 13
<code>listOfChanges</code> ^o	page 44
<code>listOfSubTask</code>	page 44
<code>listOfRanges</code>	page 44

Table 2.20: Attributes and nested elements for `repeatedTask`. ^odenotes optional elements and attributes.

Listing 2.44 shows the use of the `repeatedTask` element. In the example, `task1` is repeated three times, each time with a different value for a model parameter `w`.

```

1 <task id="task1" modelReference="model1" simulationReference="simulation1" />
2 <repeatedTask id="task3" resetModel="false" range="current"
3   xmlns:s='http://www.sbml.org/sbml/level3/version1/core'>
4   <listOfRanges>
5     <vectorRange id="current">
6       <value> 1 </value>
7       <value> 4 </value>
8       <value> 10 </value>
9     </vectorRange>
10  </listOfRanges>
11  <listOfChanges>
12    <setValue target="/s:sbml/s:model/s:listOfParameters/s:parameter[@id='w']" modelReference="model1">
13      <listOfVariables>
14        <variable id="val" name="current range value" target="#current" />
15      </listOfVariables>
16      <math xmlns="http://www.w3.org/1998/Math/MathML">
17        <ci> val </ci>
18      </math>
19    </setValue>
20  </listOfChanges>
21  <listOfSubTasks>
22    <subTask task="task1" />
23  </listOfSubTasks>
24 </repeatedTask>

```

Listing 2.44: The `repeatedTask` element

range

The `RepeatedTask` has a required attribute `range` of type `SIDRef`. It specifies which `range` defined in the `listOfRanges` this repeated task iterates over. Listing 2.44 shows an example of a `repeatedTask` iterating over a single range comprising the values: 1, 4 and 10. If there are multiple ranges in the `listOfRanges`, then only the master `range` identified by this attribute determines how many iterations there will be in the `repeatedTask`. All other ranges must allow for at least as many iterations as the master range, and will be moved through in lock-step; their values can be used in `setValue` constructs.

resetModel

The `repeatedTask` has a required attribute `resetModel` of type `boolean`. It specifies whether the model should be reset to the initial state before processing an iteration of the defined `subTasks`. Here initial state refers to the state of the model as given in the `listOfModels`.

In the example in Listing 2.44 the repeated task is not to be reset, so a change is made, `task1` is carried out, another change is made, then `task1` continues from there, another change is applied, and `task1` is carried out a last time.

listOfChanges

The optional `listOfChanges` element contains one or many `SetValue` elements. These elements allow the modification of values in the model prior to the next iteration of the `RepeatedTask`.

listOfSubTasks

The required `listOfSubTasks` contains one or more `subTasks` that specify which `Tasks` are performed in every iteration of the `RepeatedTask`. All `subTasks` have to be carried out sequentially, each continuing from the current model state (i.e. as at the end of the previous `subTask`, assuming it simulates the same model), and with their results concatenated (thus appearing identical to a single complex simulation). The order in which to run multiple `subTasks` must be specified using the `order` attribute on the `subTask`.

```
1 <listOfSubTasks>
2   <subTask task="task1" order="2"/>
3   <subTask task="task2" order="1"/>
4 </listOfSubTasks>
```

Listing 2.45: *The subTask element. In this example the task task2 must be executed before task1.*

listOfRanges

The `listOfRanges` defines one or more `ranges` used in the `repeatedTask`.

`Ranges` are the iterative element of the repeated simulation experiment. Each `Range` defines a collection of values to iterate over. The `id` attribute of the ranges can be used to refer to the current value of a range. When the `id` attribute is used in a `listOfVariables` within the `RepeatedTask` its value is to be replaced with the current value of the `Range`.

2.2.9 Task components

2.2.9.1 SubTask

A `SubTask` (Figure 2.13 on page 42) defines the subtask which is executed in every iteration of the enclosing `RepeatedTask`. The `SubTask` has a required attribute `task` that references the `id` of another `AbstractTask`. The order in which to run multiple `subTasks` must be specified via the required attribute `order`.

task

The required element `task` of data type `StringRef` specifies the `AbstractTask` executed by this `SubTask`.

order

The required attribute `order` of data type `integer` specifies the order in which to run multiple `subTasks` in the `listOfSubTasks`. To specify that one `subTask` should be executed before another its `order` attribute must have a lower number (e.g. in Listing 2.45).

2.2.9.2 SetValue

The `SetValue` class (Figure 2.13 on page 42) allows the modification of the `model` prior to the next execution of the `subTasks`. The changes to the model are defined in the `listOfChanges` of the `RepeatedTask`.

`SetValue` inherits from the `ComputeChange` class, which allows it to compute arbitrary expressions involving a number of `variables` and `parameters`. `SetValue` has a mandatory `modelReference` attribute, and the optional attributes `range` and `symbol`.

The value to be changed is identified via the combination of the attributes `modelReference` and either `symbol` or `target`, in order to select an implicit or explicit variable within the referenced model.

As in `functionalRange`, the attribute `range` may be used as a shorthand to specify the `id` of another `Range`. The current value of the referenced range may then be used within the function defining this `FunctionalRange`, just as if that range had been referenced using a `variable` element, except that the `id` of the range is used directly. In other words, whenever the expression contains a `ci` element that contains the value specified in the `range` attribute, the value of the referenced range is to be inserted.

The `math` contains the expression computing the value by referring to optional `parameters`, `variables` or `ranges`. Again as for `functionalRange`, variable references retrieve always the current value of the model variable or range at the current iteration of the enclosing `repeatedTask`.

```

1 <listOfChanges>
2   <setValue target="/s:sbml/s:model/s:listOfParameters/s:parameter[@id='w']"
3     range="current" modelReference="model1">
4     <math xmlns="http://www.w3.org/1998/Math/MathML">
5       <ci> current </ci>
6     </math>
7   </setValue>
8 </listOfChanges>

```

Listing 2.46: A `setValue` element setting `w` to the values of the range with `id` `current`.

2.2.9.3 Range

The `Range` class is the abstract base class for the different types of ranges, i.e. `UniformRange`, `VectorRange`, and `FunctionalRange` (Figure 2.14).

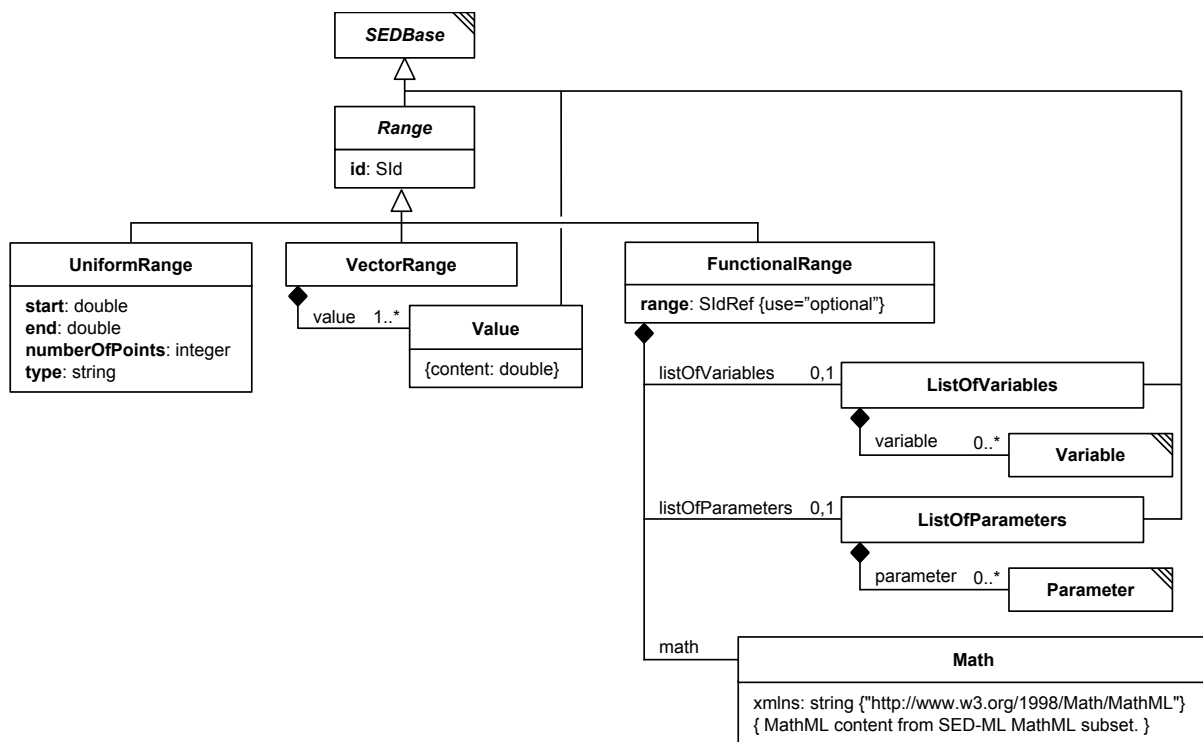

Figure 2.14: The SED-ML Range class

2.2.9.3.1 UniformRange

The `UniformRange` (Figure 2.14) allows the definition of a `Range` with uniformly spaced values. In this it is quite similar to what is used in the `UniformTimeCourse`. The `UniformRange` is defined via three mandatory attributes: `start`, the start value; `end`, the end value and `numberOfPoints` which defines the number of points in addition to the start value (the actual items in the range are `numberOfPoints+1`). A fourth attribute `type` that can take the values `linear` or `log` determines whether

to draw the values logarithmically (with a base of 10) or linearly.

For example, the following `UniformRange` will produce 101 values uniformly spaced on the interval [0, 10] in ascending order.

```
1 <uniformRange id="current" start="0.0" end="10.0" numberOfPoints="100" type="linear" />
```

Listing 2.47: *The UniformRange element*

The following logarithmic example generates the three values 1, 10 and 100.

```
1 <uniformRange id="current" start="1.0" end="100.0" numberOfPoints="2" type="log" />
```

Listing 2.48: *The UniformRange element with a logarithmic range.*

2.2.9.3.2 VectorRange

The `VectorRange` (Figure 2.14 on the previous page) describes an ordered collection of real values, listing them explicitly within child `value` elements.

For example, the range below iterates over the values 1, 4 and 10 in that order.

```
1 <vectorRange id="current">
2   <value> 1 </value>
3   <value> 4 </value>
4   <value> 10 </value>
5 </vectorRange>
```

Listing 2.49: *The VectorRange element*

2.2.9.3.3 Value

The `Value` (Figure 2.14 on the preceding page) describes a single value, e.g., the `Values` in a `VectorRange`.

2.2.9.3.4 FunctionalRange

The `FunctionalRange` (Figure 2.14 on the previous page) constructs a range through calculations that determine the next value based on the value(s) of other range(s) or model variables. In this it is similar to the `ComputeChange` element, and shares some of the same child elements (but is no subclass of `ComputeChange`). It consists of an optional attribute `range`, two optional elements `listOfVariables` and `listOfParameters`, and a required element `math`.

The optional attribute `range` of type `SidRef` may be used as a shorthand to specify the `id` of another `Range`. The current value of the referenced range may then be used within the function defining this `FunctionalRange`, just as if that range had been referenced using a `variable` element, except that the `id` of the range is used directly. In other words, whenever the expression contains a `ci` element that contains the value specified in the `range` attribute, the value of the referenced range is to be inserted.

In the `listOfVariables`, the `variable` elements define identifiers referring to model variables or range values, which may then be used within the `math` expression. These references always retrieve the current value of the model variable or range at the current iteration of the enclosing `repeatedTask`.

The `math` encompasses the mathematical expression that is used to compute the value for the `FunctionalRange` at each iteration of the enclosing `repeatedTask`.

For example:

```
1 <functionalRange id="current" range="index"
2   xmlns:s='http://www.sbml.org/sbml/level3/version1/core'>
3   <listOfVariables>
4     <variable id="w" name="current parameter value" modelReference="model2"
5       target="/s:sbml/s:model/s:listOfParameters/s:parameter[@id='w']" />
6   </listOfVariables>
7   <math xmlns="http://www.w3.org/1998/Math/MathML">
8     <apply>
9       <times/>
10      <ci> w </ci>
11      <ci> index </ci>
12    </apply>
13  </math>
14 </functionalRange>
```

Listing 2.50: *An example of a functionalRange where a parameter w of model model2 is multiplied by index each time it is called.*

Here is another example, this time using the values in a piecewise expression:

```

1 <uniformRange id="index" start="0" end="10" numberOfPoints="100" />
2 <functionalRange id="current" range="index">
3   <math xmlns="http://www.w3.org/1998/Math/MathML">
4     <piecewise>
5       <piece>
6         <cn> 8 </cn>
7         <apply>
8           <lt />
9           <ci> index </ci>
10          <cn> 1 </cn>
11         </apply>
12       </piece>
13       <piece>
14         <cn> 0.1 </cn>
15         <apply>
16           <and />
17           <apply>
18             <geq />
19             <ci> index </ci>
20             <cn> 4 </cn>
21           </apply>
22           <apply>
23             <lt />
24             <ci> index </ci>
25             <cn> 6 </cn>
26           </apply>
27         </apply>
28       </piece>
29       <otherwise>
30         <cn> 8 </cn>
31       </otherwise>
32     </piecewise>
33   </math>
34 </functionalRange>

```

Listing 2.51: A `functionalRange` element that returns 8 if `index` is smaller than 1, 0.1 if `index` is between 4 and 6, and 8 otherwise.

2.2.10 DataGenerator

The `DataGenerator` class prepares the raw simulation results for later output (Figure 2.15 on the following page). It encodes the post-processing to be applied to the simulation data. The post-processing steps could be anything, from simple normalisations of data to mathematical calculations.

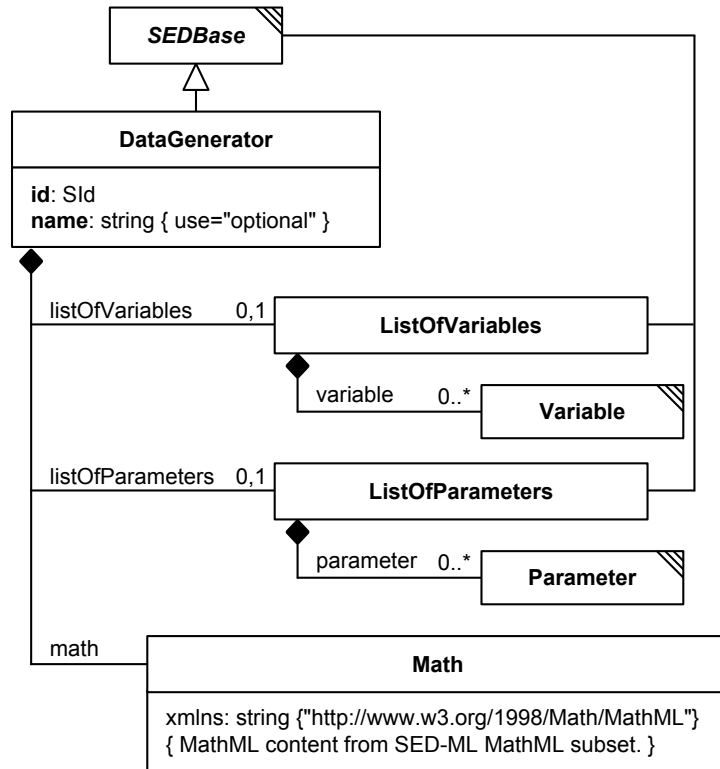

Figure 2.15: The SED-ML DataGenerator class. Note that Parameter and Variable are subclasses of SEDBase; the respective inheritance connections are not shown in the figure.

Each instance of the DataGenerator class is identifiable within the experiment by its unambiguous `id`. It can be further characterised by an optional `name`. The required `math` element contains a `mathML` expression for the calculation of the DataGenerator. Variable and Parameter instances can be used to encode the mathematical expression.

Table 2.21 shows all attributes and sub-elements for the `dataGenerator` element.

attribute	description
<code>metaid</code> ^o	page 12
<code>id</code>	page 17
<code>name</code> ^o	page 17
sub-elements	description
<code>math</code>	page 17
<code>notes</code> ^o	page 13
<code>annotation</code> ^o	page 13
<code>listOfVariables</code> ^o	page 14
<code>listOfParameters</code> ^o	page 14

Table 2.21: Attributes and nested elements for `dataGenerator`. ^o denotes optional elements and attributes.

Listing 2.52 shows the use of the `dataGenerator` element. In the example the `listOfDataGenerator` contains two `dataGenerator` elements. The first one, `d1`, refers to the task definition `task1` (which itself refers to a particular model), and from the corresponding model it reuses the symbol `time`. The second one, `d2`, references a particular species defined in the same model (and referred to via the `taskReference="task1"`). The model species with `id PX` is reused for the data generator `d2` without further post-processing.

```

1 <listOfDataGenerators>
2   <dataGenerator id="d1" name="time">
3     <listOfVariables>
4       <variable id="time" taskReference="task1" symbol="urn:sedml:symbol:time" />
5     </listOfVariables >
6     <listOfParameters />
7     <math xmlns="http://www.w3.org/1998/Math/MathML">
8       <ci> time </ci>
9     </math>
10  </dataGenerator>
11  <dataGenerator id="d2" name="LaCI repressor">
12    <listOfVariables>
13      <variable id="v1" taskReference="task1"
14        target="/sbml:sbml/sbml:model/sbml:listOfSpecies/sbml:species[@id='PX']" />
15    </listOfVariables>
16    <math xmlns="http://www.w3.org/1998/Math/MathML">
17      <math:ci>v1</math:ci>
18    </math>
19  </dataGenerator>
20 </listOfDataGenerators>

```

Listing 2.52: *Definition of two dataGenerator elements, time and LaCI repressor*

2.2.11 Output

The abstract [Output](#) class describes how the results of a simulation are presented (Figure 2.16 on the next page). The available output classes are plots ([Plot2D](#) and [Plot3D](#)) and reports ([Report](#)). The data used in [Outputs](#) is provided via [DataGenerators](#).

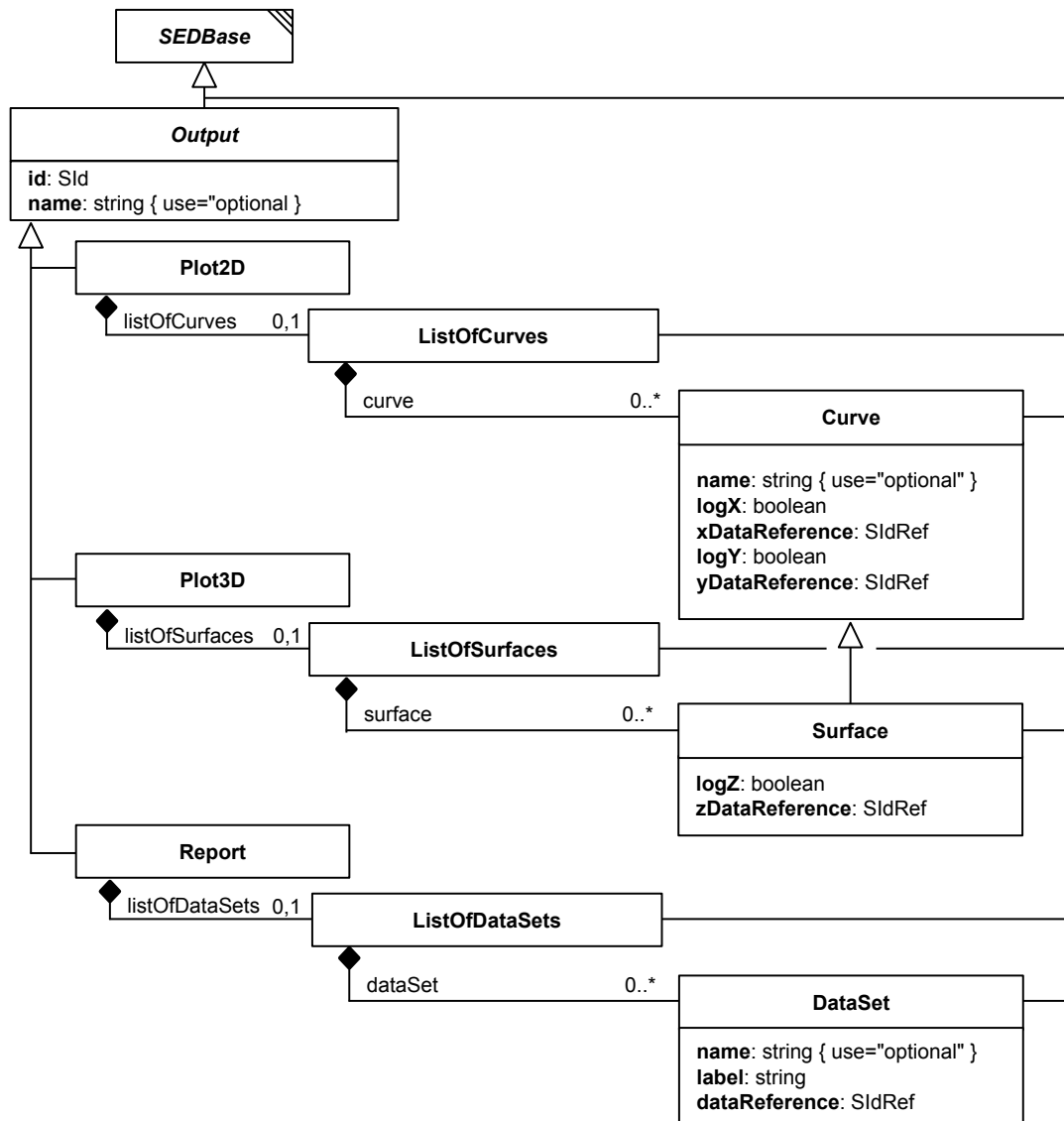

Figure 2.16: The SED-ML Output class. Note that *ListOfCurves*, *Curve*, *ListOfSurfaces*, *Surface*, *ListOfDataSets*, *DataSet* and *DataGenerator* are subclasses of *SEDBase*; the respective inheritance connections are not shown in the figure.

Note that even though the terms **Plot2D** and **Plot3D** are used, the exact type of plot is not specified. In other words, whether the 3D plot represents a surface plot, or three dimensional lines in space, cannot be distinguished by SED-ML Level 1 Version 3 alone.

2.2.11.1 Plot2D

The **Plot2D** class is used for two dimensional plot outputs (Figure 2.16). The **Plot2D** contains a number of **Curve** definitions in the **listOfCurves**, defining the **curves** to be plotted in the the 2D plot. Table 2.22 on the next page shows all attributes and sub-elements for the **plot2D** element.

Listing 2.53 shows the use of the **listOfCurves** element. The example shows the definition of a **Plot2D** containing one **Curve** inside the **listOfCurves**.

```

1 <plot2D>
2   <listOfCurves>
3     <curve>
4       [CURVE DEFINITION]
5     </curve>
6   </listOfCurves>
7 </plot2D>

```

Listing 2.53: The *plot2D* element with the nested *listOfCurves* element.

attribute	description
metaid ^o	page 12
name ^o	page 17
sub-elements	description
notes ^o	page 13
annotation ^o	page 13
listOfCurves ^o	page 52

Table 2.22: Attributes and nested elements for *plot2D*. ^odenotes optional elements and attributes.

2.2.11.2 Plot3D

The `Plot3D` class is used for three dimensional plot outputs (Figure 2.16 on the previous page). The `Plot3D` contains a number of `Surface` definitions in the `listOfSurfaces`. Table 2.23 shows all attributes and sub-elements for the `plot3D` element.

attribute	description
metaid ^o	page 12
name ^o	page 17
sub-elements	description
notes ^o	page 13
annotation ^o	page 13
listOfSurfaces ^o	page 53

Table 2.23: Attributes and nested elements for *plot3D*. ^odenotes optional elements and attributes.

Listing 2.54 shows the use of the `plot3D` element. The example shows the definition of a `Surface` for the three dimensional plot inside the `listOfSurfaces`.

```

1 <plot3D>
2   <listOfSurfaces>
3     <surface>
4       [SURFACE DEFINITION]
5     </surface>
6     [FURTHER SURFACE DEFINITIONS]
7   </listOfSurfaces>
8 </plot3D>
```

Listing 2.54: The *plot3D* element with the nested *listOfSurfaces* element

2.2.11.3 Report

The `Report` class defines a data table consisting of several single instances of the `DataSet` in the `listOfDataSets` (Figure 2.16 on the preceding page). Its output returns the simulation result processed via `DataGenerators` in actual numbers. The columns of the report table are defined by creating an instance of the `DataSet` for each column.

Table 2.24 on the next page shows all attributes and sub-elements for the `report` element.

Listing 2.55 shows the use of the `listOfDataSets` element.

```

1 <report>
2   <listOfDataSets>
3     <dataSet>
4       [DATA REFERENCE]
5     </dataSet>
6   </listOfDataSets>
7 </report>
```

Listing 2.55: The *report* element with the nested *listOfDataSets* element

The simulation result itself, i.e. concrete result numbers, are not stored in SED-ML, but the directive

attribute	description
metaid ^o	page 12
name ^o	page 17
sub-elements	description
notes ^o	page 13
annotation ^o	page 13
listOfDataSets ^o	page 54

Table 2.24: *Attributes and nested elements for `report`. ^odenotes optional elements and attributes.*

how to calculate them from the output of the simulator is provided through the `dataGenerator`. The encoding of simulation results is not part of SED-ML Level 1 Version 3.

2.2.12 Output components

In this section the `Output` components `Curve`, `Surface`, and `DataSet` are described.

2.2.12.1 Curve

A `Curve` is a two-dimensional `Output` component representing a (processed) simulation result (Figure 2.16 on page 50). Zero or more `Curve` instances define a `plot2D` (Figure 2.16 on page 50). A `curve` needs a `dataGenerator` reference to refer to the data that will be plotted on the x-axis, using the `xDataReference`. A second `dataGenerator` reference is needed to refer to the data that will be plotted on the y-axis, using the `yDataReference`. Table 2.25 shows all attributes and sub-elements for the `curve` element.

attribute	description
metaid ^o	page 12
id	page 17
name ^o	page 17
sub-elements	description
logX	page 52
xDataReference	page 53
logY	page 53
yDataReference	page 53
sub-elements	description
notes ^o	page 13
annotation ^o	page 13

Table 2.25: *Attributes and nested elements for `curve`. ^odenotes optional elements and attributes.*

Listing 2.56 shows the use of the `curve` element. In the example a single curve is created. Results for the x-axis are generated by the `dataGenerator` `dg1`, results for the y-axis are generated by the `dataGenerator` `dg2`. Both `dg1` and `dg2` need to be defined in the `listOfDataGenerators`. The x-axis is plotted logarithmically.

```

1 <listOfCurves>
2   <curve id="c1" name="v1 / time" xDataReference="dg1" yDataReference="dg2" logX="true" logY="false" />
3 </listOfCurves>

```

Listing 2.56: *The SED-ML `curve` element, defining the output curve showing the result of simulation for the referenced `dataGenerators`*

`logX`

`logX` is a required attribute of the `Curve` class and defines whether or not the data output on the x-axis is logarithmic. The data type of `logX` is `boolean`. To make the output on the x-axis of a plot logarithmic, `logX` must be set to `true`, as shown in the sample Listing 2.56.

xDataReference

The **xDataReference** is a mandatory attribute of the **Curve** object. Its content refers to a **dataGenerator** which denotes the **DataGenerator** object that is used to generate the output on the x-axis of a **Curve** in a **plot2D**. The **xDataReference** data type is **SIIdRef**. However, the valid values for the **xDataReference** are restricted to the **id** of already defined **DataGenerators**.

logY

logY is a required attribute of the **Curve** class and defines whether or not the data output on the y-axis is logarithmic. The data type of **logY** is **boolean**. To make the output on the y-axis of a plot logarithmic, **logY** must be set to **true**, as shown in the sample Listing 2.56.

yDataReference

The **yDataReference** is a mandatory attribute of the **Curve** object. Its content refers to a **dataGenerator** which denotes the **DataGenerator** object that is used to generate the output on the y-axis of a **Curve** in a **plot2D**. The **yDataReference** data type is **SIIdRef**. However, the valid values for the **yDataReference** are restricted to the **id** of already defined **DataGenerators**.

2.2.12.2 Surface

A **Curve** is a three-dimensional **Output** component representing a (processed) simulation result (Figure 2.16 on page 50). Zero or more **Surface** instances define a **plot3D** (Figure 2.16 on page 50).

Surface is a subclass of **Curve** inheriting among others the elements **xDataReference**, **yDataReference**, **logX**, and **logY**.

Creating an instance of the **Surface** class requires the definition of data on three different axis. The aforementioned **xDataReference** and **yDataReference** attributes define the **dataGenerators** for the x- and y-axis of a surface. In addition, the **zDataReference** attribute defines the output for the z-axis. All axes might be logarithmic or not. This can be specified through the **logX**, **logY**, and the **logZ** attributes in the according dataReference elements.

Table 2.26 shows all attributes and sub-elements for the **surface** element.

attribute	description
metaid ^o	page 12
id	page 17
name ^o	page 17
logX	page 52
xDataReference	page 53
logY	page 53
yDataReference	page 53
logZ	page 54
zDataReference	page 54
sub-elements	description
notes ^o	page 13
annotation ^o	page 13

Table 2.26: Attributes and nested elements for **surface**. ^o denotes optional elements and attributes.

Listing 2.57 shows the use of the **surface** element. In the example a single surface is created. Results shown on the x-axis are generated by the data generator **dg1**, results on the y-axis by dataGenerator **dg2**, results on the z-axis by dataGenerator **dg3**. All used **dataGenerators**, i.e. **dg1**, **dg2** and **dg3**, must be defined in the **listOfDataGenerators**.

```
1 <listOfSurfaces>
2   <surface id="s1" name="surface" xDataReference="dg1" yDataReference="dg2" zDataReference="dg3"
3     logX="true" logY="false" logZ="false" />
4   [FURTHER SURFACE DEFINITIONS]
```

```
5 </listOfSurfaces>
```

Listing 2.57: The SED-ML **surface** element, defining the output showing the result of the referenced task

logZ

logZ is a required attribute of the **Surface** class and defines whether or not the data output on the z-axis is logarithmic. The data type of **logZ** is **boolean**. To make the output on the z-axis of a surface plot logarithmic, **logZ** must be set to **true**, as shown in the sample Listing 2.57.

zDataReference

The **zDataReference** is a mandatory attribute of the **Surface** object. Its content refers to a **dataGenerator** which denotes the **DataGenerator** object that is used to generate the output on the z-axis of a **plot3D**. The **zDataReference** data type is **SIdRef**. However, the valid values for the **zDataReference** are restricted to the **id** of already defined **DataGenerators**.

2.2.12.3 DataSet

The **DataSet** class holds definitions of data to be used in the **Report** class (Figure 2.16 on page 50). **DataSets** are labeled references to instances of the **DataGenerator** class.

Table 2.27 shows all attributes and sub-elements for the **dataSet** element.

attribute	description
metaid ^o	page 12
id	page 17
name ^o	page 17
dataReference	page 54
label	page 54
sub-elements	description
notes ^o	page 13
annotation ^o	page 13

Table 2.27: Attributes and nested elements for **dataSet**. ^o denotes optional elements and attributes.

label

Each data set in a **Report** must have an unambiguous **label**. A **label** is a human readable descriptor of a data set for use in a **report**. For example, for a tabular data set of time series results, the **label** could be the column heading.

dataReference

The **dataReference** attribute contains the ID of a **dataGenerator** element and as such represents a link to it. The data produced by that particular **dataGenerator** fills the according **dataSet** in the **report**.

Listing 2.58 shows the use of the **dataSet** element. The example shows the definition of a **dataSet**. The referenced **dataGenerator** **dg1** must be defined in the **listOfDataGenerators**.

```
1 <listOfDataSets>
2   <dataSet id="d1" name="v1 over time" dataReference="dg1" label="_1">
3 </listOfDataSets>
```

Listing 2.58: The SED-ML **dataSet** element, defining a data set containing the result of the referenced task

3. Concepts used in SED-ML

3.1 MathML

SED-ML encodes mathematical expressions using a subset of [MathML 2.0](#) [4]. [MathML](#) is an international standard for encoding mathematical expressions using XML. It is also used as a representation of mathematical expressions in other formats, such as SBML and CellML, two of the model languages supported by SED-ML.

SED-ML files can use mathematical expressions to encode for example pre-processing steps applied to the computational model ([ComputeChange](#)), or post processing steps applied to the raw simulation data before output ([DataGenerator](#)).

SED-ML classes reference [MathML](#) expressions via the element `math` of data type [MathML](#).

3.1.1 MathML elements

The allowed MathML in SED-ML is restricted to the following subset:

- *token*: `cn`, `ci`, `csymbol`, `sep`
- *general*: `apply`, `piecewise`, `piece`, `otherwise`, `lambda`
- *relational operators*: `eq`, `neq`, `gt`, `lt`, `geq`, `leq`
- *arithmetic operators*: `plus`, `minus`, `times`, `divide`, `power`, `root`, `abs`, `exp`, `ln`, `log`, `floor`, `ceiling`, `factorial`
- *logical operators*: `and`, `or`, `xor`, `not`
- *qualifiers*: `degree`, `bvar`, `logbase`
- *trigonometric operators*: `sin`, `cos`, `tan`, `sec`, `csc`, `cot`, `sinh`, `cosh`, `tanh`, `sech`, `csch`, `coth`, `arcsin`, `arccos`, `arctan`, `arcsec`, `arccsc`, `arccot`, `arcsinh`, `arccosh`, `arctanh`, `arcsech`, `arccsch`, `arccoth`
- *constants*: `true`, `false`, `notanumber`, `pi`, `infinity`, `exponentiale`
- *MathML annotations*: `semantics`, `annotation`, `annotation-xml`

3.1.2 MathML symbols

All the operations listed above only operate on *scalar* values. However, as one of SED-ML's aims is to provide post processing on the results of simulation experiments, this basic set needs to be extended by some aggregate functions. Therefore a defined set of [MathML symbols](#) that represent vector values are supported by SED-ML. The only allowed symbols to be used in aggregate functions are the identifiers of [Variables](#) defined in the `listOfVariables` of [DataGenerators](#). These [Variables](#) represent the data collected from the simulation experiment in the associated [Task](#).

3.1.3 MathML functions

The only aggregate [MathML functions](#) available in SED-ML are `min`, `max`, `sum`, and `product`. These represent the only exceptions. At this point SED-ML does not define a complete algebra of vector values.

min

The **min** of a variable represents the smallest value the simulation experiment for that variable (Listing 3.1).

```
1 <apply>
2   <csymbol encoding="text" definitionURL="http://sed-ml.org/#min">
3     min
4   </csymbol>
5   <ci> variableId </ci>
6 </apply>
```

Listing 3.1: Example for the use of the MathML **min** function.

max

The **max** of a variable represents the largest value the simulation experiment for that variable (Listing 3.2).

```
1 <apply>
2   <csymbol encoding="text" definitionURL="http://sed-ml.org/#max">
3     max
4   </csymbol>
5   <ci> variableId </ci>
6 </apply>
```

Listing 3.2: Example for the use of the MathML **max** function.

sum

The **sum** of a variable represents the sum of all values of the variable returned by the simulation experiment (Listing 3.3).

```
1 <apply>
2   <csymbol encoding="text" definitionURL="http://sed-ml.org/#sum">
3     sum
4   </csymbol>
5   <ci> variableId </ci>
6 </apply>
```

Listing 3.3: Example for the use of the MathML **sum** function.

product

The **product** of a variable represents the multiplication of all values of the variable returned by the simulation experiment (Listing 3.4).

```
1 <apply>
2   <csymbol encoding="text" definitionURL="http://sed-ml.org/#product">
3     product
4   </csymbol>
5   <ci> variableId </ci>
6 </apply>
```

Listing 3.4: Example for the use of the MathML **product** function.

3.1.4 NA values

NA (not available) values can occur within a simulation experiment. Examples are missing values in a [DataSource](#) or simulation results with NA values. All math operations encoded in [MathML](#) in SED-ML are well defined on NA values.

NA values in a [Curve](#) or [Surface](#) should be ignored during plotting.

3.2 URI scheme

URIs are used in SED-ML as a mechanism

- to reference models ([3.2.1 Model references](#))
- to reference data files ([3.2.2 Data references](#))
- to specify the language of the referenced model ([3.2.3 Language references](#))

- to specify the format of the referenced dataset ([3.2.4 Data format references](#))
- to enable addressing implicit model variables ([3.2.5 Symbols](#))

In addition, annotation of SED-ML elements should use a standardised URI [Annotations Scheme](#) to ensure long-time availability of information that can unambiguously be identified.

3.2.1 Model references

The URI of a [model](#) should preferably point to a public, consistent location that provides the model description file. References to curated, open model bases are recommended, such as the BioModels Database. However, any resource registered with MIRIAM resources¹ can easily be referenced.

One way for referencing a model from a SED-ML file is adopted from the [MIRIAM URI Scheme](#). MIRIAM enables identification of a data resource (in this case a model resource) by a predefined URN. A data entry inside that resource is identified by an ID. That way each single model in a particular model repository can be unambiguously referenced. One model repository that is part of MIRIAM resources is the [BioModels Database](#) [17]. Its data resource name in MIRIAM is `urn:miriam:biomodels.db`. To refer to a particular model, a standardised identifier scheme is defined in [MIRIAM Resources](#)². The ID entry maps to a particular model in the model repository. That model is never deleted. A sample BioModels Database ID is `BIOMD0000000048`. Together with the data resource name it becomes unambiguously identifiable by the URN `urn:miriam:biomodels.db:BIOMD0000000048`.

SED-ML does not specify how to resolve the URNs. However, MIRIAM Resources offers web services to do so³. For the above example of the `urn:miriam:biomodels.db:BIOMD0000000048` model, the resolved URL may look like <http://www.ebi.ac.uk/biomodels-main/BIOMD0000000048>.

For additional information see the [source](#) attribute on [Model](#).

An alternative means to obtain a model may be to provide a single resource containing necessary models and a SED-ML file. Although a specification of such a resource is beyond the scope of this document, the recommended means is the [COMBINE archive](#).

3.2.2 Data references

One way for referencing a data file from a SED-ML file is adopted from the [MIRIAM URI Scheme](#). MIRIAM enables identification of a data resource by a predefined URN.

For additional information see the [source](#) attribute on [DataDescription](#).

An alternative means to obtain a data file may be to provide a single resource containing necessary data files and the SED-ML file is the [COMBINE archive](#).

3.2.3 Language references

The evaluation of a SED-ML document is required in order for software to decide whether or not it can be used in a particular simulation environment. One crucial criterion is the particular model representation language used to encode the [model](#). A simulation software usually only supports a small subset of the representation formats available to model biological systems computationally.

To help software decide whether or not it supports a SED-ML description file, the information on the [model](#) encoding for each referenced [model](#) can be provided through the [language](#) attribute, as the description of a language name and version through an unrestricted `String` is error-prone. A prerequisite for a language to be fully supported by SED-ML is that a formalised language definition, e.g., an XML Schema, is provided online. SED-ML also defines a set of standard URIs to refer to particular language definitions.

To specify the language a model is encoded in, a set of pre-defined SED-ML URNs can be used ([Table 3.1 on the following page](#)). The structure of SED-ML language URNs is `urn:sedml:language:name.version`. SED-ML allows to specify a model representation format very generally as being `XML`, if no standardised representation format has been used to encode the model. On the other hand, one can be as spe-

¹<http://www.ebi.ac.uk/miriam/main/>

²<http://www.ebi.ac.uk/miriam/>

³<http://www.ebi.ac.uk/miriam/>

cific as defining a model being in a particular version of a language, e.g., SBML Level 3 Version 1 as `urn:sedml:language:sbml.level-3.version-1`.

For additional information see the `language` attribute on `Model`.

Language	URN
CellML (generic)	<code>urn:sedml:language:cellml</code>
CellML 1.0	<code>urn:sedml:language:cellml.1_0</code>
CellML 1.1	<code>urn:sedml:language:cellml.1_1</code>
NeuroML (generic)	<code>urn:sedml:language:neuroml</code>
NeuroML Version 1.8.1 Level 1	<code>urn:sedml:language:neuroml.version-1.8.1.level-1</code>
NeuroML Version 1.8.1 Level 2	<code>urn:sedml:language:neuroml.version-1.8.1.level-2</code>
SBML (generic)	<code>urn:sedml:language:sbml</code>
SBML Level 1 Version 1	<code>urn:sedml:language:sbml.level-1.version-1</code>
SBML Level 1 Version 2	<code>urn:sedml:language:sbml.level-1.version-2</code>
SBML Level 2 Version 1	<code>urn:sedml:language:sbml.level-2.version-1</code>
SBML Level 2 Version 2	<code>urn:sedml:language:sbml.level-2.version-2</code>
SBML Level 2 Version 3	<code>urn:sedml:language:sbml.level-2.version-3</code>
SBML Level 2 Version 4	<code>urn:sedml:language:sbml.level-2.version-4</code>
SBML Level 3 Version 1	<code>urn:sedml:language:sbml.level-3.version-1</code>
SBML Level 3 Version 2	<code>urn:sedml:language:sbml.level-3.version-2</code>
VCML (generic)	<code>urn:sedml:language:vcml</code>

Table 3.1: Predefined model language URNs. The latest list of language URNs is available from <http://sed-ml.org/>.

3.2.4 Data format references

To help software decide whether or not it supports a SED-ML file, the information on the `dataDescription` encoding for each referenced `dataDescription` can be provided through the `format` attribute.

To specify the format of a `dataDescription`, a set of pre-defined SED-ML URNs can be used (Table 3.2). The structure of SED-ML format URNs is `urn:sedml:format:name.version`.

If it is not explicitly defined the default value for `format` is `urn:sedml:format:numl`, referring to NuML representation of the data. However, the use of the `format` attribute is strongly encouraged.

For additional information see the `format` attribute on `DataDescription` and the description of individual formats and their use in SED-ML below.

Data Format	URN
NuML (generic)	<code>urn:sedml:format:numl</code>
NuML Level 1 Version 1	<code>urn:sedml:format:numl.level-1.version-1</code>
CSV	<code>urn:sedml:format:csv</code>
TSV	<code>urn:sedml:format:tsv</code>

Table 3.2: Predefined `dataDescription` format URNs. The latest list of format URNs is available from <http://sed-ml.org/>.

3.2.4.1 NuML (Numerical Markup Language)

NuML is an exchange format for numerical data. Data in the NuML format (`urn:sedml:format:numl`) is defined via `resultComponents` with a single dataset corresponding to a single `resultComponent`. In the case that a NuML file consists of multiple `resultComponents` the first `resultComponent` contains the data used in the `DataDescription`. There is currently no mechanism in SED-ML to reference the additional `resultComponents`.

If a `dimensionDescription` is set on the `DataDescription`, than this `dimensionDescription` must be

identical to the [dimensionDescription](#) of the NuML file.

3.2.4.2 CSV (Comma Separated Values)

Data in the [CSV](#) format ([urn:sedml:format:csv](#)) must follow the following rules when used in combination with SED-ML:

- Each record is one line - Line separator may be LF (0x0A) or CRLF (0x0D0A), a line separator may also be embedded in the data (making a record more than one line but still acceptable).
- Fields are separated with commas.
- Embedded commas - Field must be delimited with double-quotes.
- Leading and trailing whitespace is ignored - Unless the field is delimited with double-quotes in that case the whitespace is preserved.
- Embedded double-quotes - Embedded double-quote characters must be doubled, and the field must be delimited with double-quotes.
- Embedded line-breaks - Fields must be surrounded by double-quotes.
- Always Delimiting - Fields may always be delimited with double quotes, the delimiters will be parsed and discarded by the reading applications.
- The first record is the header record defining the unique column ids
- Lines starting with "#" are treated as comment lines and ignored
- Empty lines are allowed and ignored
- For numerical data the "." decimal separator is used
- The following strings are interpreted as NaN: "", "#N/A", "#N/A N/A", "#NA", "-1.#IND", "-1.#QNAN", "-NaN", "-nan", "1.#IND", "1.#QNAN", "N/A", "NA", "NULL", "NaN", "nan".

A dataset in [CSV](#) is always encoding two dimensional data.

When using data in the [CSV](#) format SED-ML, the [dimensionDescription](#) is required on the [DataDescription](#).

The [dimensionDescription](#) must consist of an outer [compositeDescription](#) with `indexType="integer"` which allows to reference the rows of the [CSV](#) by index and a inner [compositeDescription](#) which allows to reference the columns of the [CSV](#) by their column header id. Within the inner [compositeDescription](#) exactly one [atomicDescription](#) must exist. All data in the [CSV](#) must have the same type which is defined via the `valueType` on the [atomicDescription](#).

Below an example of the required [dimensionDescription](#) for a [CSV](#) is provided. In the example the `time` and `S1` columns are read from the [CSV](#) file

```
1 # ./example.csv
2 time, S1, S2
3 0.0, 10.0, 0.0
4 0.1, 9.9, 0.1
5 0.2, 9.8, 0.2
```

Listing 3.5: *Example CSV*

```
1
2 <dataDescription id="datacsv" name="Example CSV dataset" source="./example.csv" format="
   urn:sedml:format:csv">
3   <dimensionDescription>
4     <compositeDescription indexType="integer" name="Index">
5       <compositeDescription indexType="string" name="ColumnIds">
6         <atomicDescription valueType="double" name="Values" />
7       </compositeDescription>
8     </compositeDescription>
9   </dimensionDescription>
10  <listOfDataSources>
11    <dataSource id="dataTime">
12      <listOfSlices>
13        <slice reference="ColumnIds" value="time" />
14      </listOfSlices>
15    </dataSource>
```

```

16     <dataSource id="dataS1">
17       <listOfSlices>
18         <slice reference="ColumnIds" value="S1" />
19       </listOfSlices>
20     </dataSource>
21 </listOfDataSources>
22 ...
23 </dataDescription>

```

Listing 3.6: *SED-ML dimensionDescription element for the example.csv*

3.2.4.3 TSV (Tab Separated Values)

The format **TSV** (`urn:sedml:format:tsv`) is defined identical to **CSV** with the exceptions listed below

- Fields are separated with tabs instead of commas.
- Embedded tab - Field must be delimited with double-quotes (embedded comma field must not be delimited with double quotes)

3.2.5 Symbols

Some variables used in a simulation experiment are not explicitly defined in the model, but may be implicitly contained in it. For example, to plot a variable's behaviour over time, that variable is defined in an SBML model, whereas time is not explicitly defined.

SED-ML can refer to such implicit variables via the **Symbol** concept. Such implicit variables are defined using the SED-ML URN scheme `urn:sedml:symbol:implicitVariable`.

For example, to refer in a SED-ML file to the definition of time, the URN `urn:sedml:symbol:time` is used.

Table 3.3 lists the predefined symbols in SED-ML.

Language	URN	Definition
SBML	<code>urn:sedml:symbol:time</code>	Time in SBML is an intrinsic model variable that is addressable in model equations via a csymbol <code>time</code> .

Table 3.3: *Predefined symbols in SED-ML. The latest list of symbols is available from <http://sed-ml.org>.*

3.2.6 Annotation Scheme

When annotating SED-ML elements with semantic **annotations**, the **MIRIAM URI Scheme** should be used. In addition to providing the data type (e.g., PubMed) and the particular data entry inside that data type (e.g., 10415827), the relation of the annotation to the annotated element should be described using the standardized **biomodels.net qualifier**. The list of qualifiers, as well as further information about their usage, is available from <http://www.biomodels.net/qualifiers/>.

3.3 XPath

XPath is a language for finding and referencing information in an XML document [6]. Within SED-ML Level 1 Version 3, XPath version 1 expressions are used to identify nodes and attributes within an XML representation in the following ways:

- Within a **Variable** definition, where **XPath** identifies the model variable required for manipulation in SED-ML.
- Within a **Change** definition, where **XPath** is used to identify the target XML to which a change should be applied.

For proper application, [XPath](#) expressions should contain prefixes that allow their resolution to the correct XML namespace within an XML document. For example, the [XPath](#) expression referring to a species *X* in an SBML model:

```
/sbml:sbml/sbml:model/sbml:listOfSpecies/sbml:species[@id='X'] ✓ -CORRECT
```

is preferable to

```
/sbml/model/listOfSpecies/species[@id='X'] ✗ -INCORRECT
```

which will only be interpretable by standard XML software tools if the SBML file declares no namespaces (and hence is invalid SBML).

Following the convention of other [XPath](#) host languages such as XPointer and XSLT, the prefixes used within [XPath](#) expressions must be declared using namespace declarations within the SED-ML document, and be in-scope for the relevant expression. Thus for the correct example above, there must also be an ancestor element of the node containing the XPath expression that has an attribute like:

```
xmlns:sbml='http://www.sbml.org/sbml/level3/version1/core'
```

(a different namespace URI may be used; the key point is that the prefix 'sbml' must match that used in the XPath expression).

3.4 NuML

The Numerical Markup Language ([NuML](#)) aims to standardize the exchange and archiving of numerical results. Additional information including the [NuML](#) specification is available from <https://github.com/NuML/NuML>.

[NuML](#) constructs are used in SED-ML for referencing external data sets in the [DataDescription](#) class. [NuML](#) is used to define the [DimensionDescription](#) of external datasets in the [DataDescription](#). In addition, [NuML](#) [SIDs](#) are used for retrieving subsets of data via either the [indexSet](#) element in the [DataSource](#) or within the [Slice](#) class.

3.5 KiSAO

The Kinetic Simulation Algorithm Ontology ([KiSAO](#) [7]) is used in SED-ML to specify simulation [algorithms](#) and [algorithmParameters](#). [KiSAO](#) is a community-driven approach of classifying and structuring simulation approaches by model characteristics and numerical characteristics. The ontology is available in OWL format from [BioPortal](#) at <http://purl.bioontology.org/ontology/KiSAO>.

Defining simulation [algorithms](#) through [KISAO](#) terms not only identifies the simulation algorithm used for the SED-ML simulation, it also enables software to find related algorithms, if the specific implementation is not available. For example, software could decide to use the CVODE integration library for an analysis instead of a specific Runge Kutta 4,5 implementation.

Should a particular simulation algorithm or algorithm parameter not exist in [KISAO](#), please request one via <http://www.biomodels.net/kisao/>.

3.6 COMBINE archive

A [COMBINE archive](#) [1] is a single file that supports the exchange of all the information necessary for a modeling and simulation experiment in biology. A [COMBINE archive](#) file is a ZIP container that includes a manifest file, listing the content of the archive, an optional metadata file adding information about the archive and its content, and the files describing the model. The content of a [COMBINE archive](#) consists of files encoded in COMBINE standards whenever possible, but may include additional files defined by an Internet Media Type. Several tools that support the [COMBINE archive](#) are available, either as independent libraries or embedded in modeling software.

The [COMBINE archive](#) is described at <http://co.mbine.org/documents/archive> and in [1].

[COMBINE archives](#) are the recommended means for distributing simulation experiment descriptions in SED-ML, the respective data and model files, and the [Outputs](#) of the simulation experiment (figures and

reports). All SED-ML specification examples in Appendix A are available as [COMBINE archive](#) from <http://sed-ml.org>.

3.7 SED-ML resources

Information on SED-ML can be found on <http://sed-ml.org>. The SED-ML XML Schema, the UML schema, SED-ML examples, and additional information is available from <https://github.com/sed-ml>.

4. Acknowledgements

The SED-ML specification is developed with the input of many people. The following individuals served as past SED-ML Editors and contributed to SED-ML specifications. Their efforts helped shape what SED-ML is today.

- Richard Adams (editor, 2011-2012)
- Frank Bergmann (editor, 2011-2014)
- Jonathan Cooper (editor, 2012-2015)
- Nicolas Le Novère (editorial advisor, 2011-2012, 2013)
- Andrew Miller (editor, 2011-2012)
- Ion Moraru (editor, 2014-2016)
- Sven Sahle (editor, 2014-2016)
- Herbert Sauro

Moreover, we would like to thank all the participants of the meetings where SED-ML has been discussed as well as the members of the SED-ML community.

A. Examples

This appendix presents selected SED-ML examples. These examples are only illustrative and do not intend to demonstrate the full capabilities of SED-ML. For a more comprehensive view of the SED-ML features refer to the specification (Chapter 2).

The presented examples use models encoded in SBML and CellML. SED-ML is not restricted to those formats, but can be used with models encoded in formats serialized in XML (see Section 3.2.3 for more information).

All specification examples listed below are available as [Combine Archives](http://sed-ml.org/) from <http://sed-ml.org/> under the *.omex file name for the respective example.

Additional SED-ML examples are available at <http://sed-ml.org/>.

A.1 Example simulation experiment (L1V3_repressilator.omex)

This example lists the SED-ML for the example in the introduction (Section 1.2).

```
1 <?xml version="1.0" encoding="UTF-8"?>
2 <!-- Created by phraSED-ML version v1.0.7 with libSBML version 5.15.0. -->
3 <sedML xmlns="http://sed-ml.org/sed-ml/level1/version3" level="1" version="3">
4   <listOfSimulations>
5     <uniformTimeCourse id="sim1" initialTime="0" outputStartTime="0" outputEndTime="1000" numberOfPoints="
      "1000">
6       <algorithm kisaoID="KISAO:0000019"/>
7     </uniformTimeCourse>
8   </listOfSimulations>
9   <listOfModels>
10    <model id="model1" language="urn:sedml:language:sbml.level-3.version-1" source="urn:miriam:biomodels.
      db:BIOMD0000000012"/>
11    <model id="model2" language="urn:sedml:language:sbml.level-3.version-1" source="model1">
12      <listOfChanges>
13        <changeAttribute target="/sbml:sbml/sbml:model/sbml:listOfParameters/sbml:parameter[@id='ps_0']/"
          @value" newValue="1.3e-05"/>
14        <changeAttribute target="/sbml:sbml/sbml:model/sbml:listOfParameters/sbml:parameter[@id='ps_a']/"
          @value" newValue="0.013"/>
15      </listOfChanges>
16    </model>
17  </listOfModels>
18  <listOfTasks>
19    <task id="task1" modelReference="model1" simulationReference="sim1"/>
20    <task id="task2" modelReference="model2" simulationReference="sim1"/>
21  </listOfTasks>
22  <listOfDataGenerators>
23    <!-- timecourse -->
24    <dataGenerator id="dg_0_0_0" name="task1.time">
25      <listOfVariables>
26        <variable id="task1_____time" symbol="urn:sedml:symbol:time" taskReference="task1"/>
27      </listOfVariables>
28      <math xmlns="http://www.w3.org/1998/Math/MathML">
29        <ci> task1_____time </ci>
30      </math>
31    </dataGenerator>
32    <dataGenerator id="dg_0_0_1" name="PX (lacI)">
33      <listOfVariables>
34        <variable id="task1_____PX" target="/sbml:sbml/sbml:model/sbml:listOfSpecies/sbml:species[@id='PX
          ']" taskReference="task1" modelReference="model1"/>
35      </listOfVariables>
36      <math xmlns="http://www.w3.org/1998/Math/MathML">
37        <ci> task1_____PX </ci>
38      </math>
39    </dataGenerator>
40    <dataGenerator id="dg_0_1_1" name="PZ (cI)">
41      <listOfVariables>
42        <variable id="task1_____PZ" target="/sbml:sbml/sbml:model/sbml:listOfSpecies/sbml:species[@id='PZ
          ']" taskReference="task1" modelReference="model1"/>
```

```

43     </listOfVariables>
44     <math xmlns="http://www.w3.org/1998/Math/MathML">
45       <ci> task1_____PZ </ci>
46     </math>
47   </dataGenerator>
48   <dataGenerator id="dg_0_2_1" name="PY (tetR)">
49     <listOfVariables>
50       <variable id="task1_____PY" target="/sbml:sbml/sbml:model/sbml:listOfSpecies/sbml:species[@id='PY
          ']" taskReference="task1" modelReference="model1"/>
51     </listOfVariables>
52     <math xmlns="http://www.w3.org/1998/Math/MathML">
53       <ci> task1_____PY </ci>
54     </math>
55   </dataGenerator>
56   <!-- pre-processing -->
57   <dataGenerator id="dg_1_0_0" name="time">
58     <listOfVariables>
59       <variable id="task2_____time" symbol="urn:sedml:symbol:time" taskReference="task2"/>
60     </listOfVariables>
61     <math xmlns="http://www.w3.org/1998/Math/MathML">
62       <ci> task2_____time </ci>
63     </math>
64   </dataGenerator>
65   <dataGenerator id="dg_1_0_1" name="PX (lacI)">
66     <listOfVariables>
67       <variable id="task2_____PX" target="/sbml:sbml/sbml:model/sbml:listOfSpecies/sbml:species[@id='PX
          ']" taskReference="task2" modelReference="model2"/>
68     </listOfVariables>
69     <math xmlns="http://www.w3.org/1998/Math/MathML">
70       <ci> task2_____PX </ci>
71     </math>
72   </dataGenerator>
73   <dataGenerator id="dg_1_1_1" name="PZ (cI)">
74     <listOfVariables>
75       <variable id="task2_____PZ" target="/sbml:sbml/sbml:model/sbml:listOfSpecies/sbml:species[@id='PZ
          ']" taskReference="task2" modelReference="model2"/>
76     </listOfVariables>
77     <math xmlns="http://www.w3.org/1998/Math/MathML">
78       <ci> task2_____PZ </ci>
79     </math>
80   </dataGenerator>
81   <dataGenerator id="dg_1_2_1" name="PY (tetR)">
82     <listOfVariables>
83       <variable id="task2_____PY" target="/sbml:sbml/sbml:model/sbml:listOfSpecies/sbml:species[@id='PY
          ']" taskReference="task2" modelReference="model2"/>
84     </listOfVariables>
85     <math xmlns="http://www.w3.org/1998/Math/MathML">
86       <ci> task2_____PY </ci>
87     </math>
88   </dataGenerator>
89   <!-- post-processing -->
90   <dataGenerator id="dg_2_0_0" name="PX/max(PX) (lacI normalized)">
91     <listOfVariables>
92       <variable id="task1_____PX" target="/sbml:sbml/sbml:model/sbml:listOfSpecies/sbml:species[@id='PX
          ']" taskReference="task1" modelReference="model1"/>
93     </listOfVariables>
94     <math xmlns="http://www.w3.org/1998/Math/MathML">
95       <apply>
96         <divide/>
97         <ci> task1_____PX </ci>
98         <apply>
99           <csymbol definitionURL="http://sed-ml.org/#max" encoding="text">max</csymbol>
100          <ci> task1_____PX </ci>
101        </apply>
102      </apply>
103    </math>
104  </dataGenerator>
105  <dataGenerator id="dg_2_0_1" name="PZ/max(PZ) (cI normalized)">
106    <listOfVariables>
107      <variable id="task1_____PZ" target="/sbml:sbml/sbml:model/sbml:listOfSpecies/sbml:species[@id='PZ
          ']" taskReference="task1" modelReference="model1"/>
108    </listOfVariables>
109    <math xmlns="http://www.w3.org/1998/Math/MathML">
110      <apply>
111        <divide/>
112        <ci> task1_____PZ </ci>
113        <apply>
114          <csymbol definitionURL="http://sed-ml.org/#max" encoding="text">max</csymbol>
115          <ci> task1_____PZ </ci>
116        </apply>
117      </apply>
118    </math>
119  </dataGenerator>
120  <dataGenerator id="dg_2_1_0" name="PY/max(PY) (tetR normalized)">
121    <listOfVariables>
122      <variable id="task1_____PY" target="/sbml:sbml/sbml:model/sbml:listOfSpecies/sbml:species[@id='PY
          ']" taskReference="task1" modelReference="model1"/>
123    </listOfVariables>
124    <math xmlns="http://www.w3.org/1998/Math/MathML">

```

```

125     <apply>
126     <divide/>
127     <ci> task1_____PY </ci>
128     <apply>
129     <csymbol definitionURL="http://sed-ml.org/#max" encoding="text">max</csymbol>
130     <ci> task1_____PY </ci>
131     </apply>
132     </apply>
133     </math>
134 </dataGenerator>
135 </listOfDataGenerators>
136 <listOfOutputs>
137   <plot2D id="timecourse" name="Timecourse of repressilator">
138     <listOfCurves>
139       <curve id="plot_0__plot_0_0_0__plot_0_0_1" logX="false" logY="false" xDataReference="dg_0_0_0"
140         yDataReference="dg_0_0_1"/>
141       <curve id="plot_0__plot_0_0_0__plot_0_1_1" logX="false" logY="false" xDataReference="dg_0_0_0"
142         yDataReference="dg_0_1_1"/>
143       <curve id="plot_0__plot_0_0_0__plot_0_2_1" logX="false" logY="false" xDataReference="dg_0_0_0"
144         yDataReference="dg_0_2_1"/>
145     </listOfCurves>
146   </plot2D>
147   <plot2D id="preprocessing" name="Timecourse after pre-processing">
148     <listOfCurves>
149       <curve id="plot_1__plot_1_0_0__plot_1_0_1" logX="false" logY="false" xDataReference="dg_1_0_0"
150         yDataReference="dg_1_0_1"/>
151       <curve id="plot_1__plot_1_0_0__plot_1_1_1" logX="false" logY="false" xDataReference="dg_1_0_0"
152         yDataReference="dg_1_1_1"/>
153       <curve id="plot_1__plot_1_0_0__plot_1_2_1" logX="false" logY="false" xDataReference="dg_1_0_0"
154         yDataReference="dg_1_2_1"/>
155     </listOfCurves>
156   </plot2D>
157   <plot2D id="postprocessing" name="Timecourse after post-processing">
158     <listOfCurves>
159       <curve id="plot_2__plot_2_0_0__plot_2_0_1" logX="false" logY="false" xDataReference="dg_2_0_0"
160         yDataReference="dg_2_0_1"/>
161       <curve id="plot_2__plot_2_1_0__plot_2_0_0" logX="false" logY="false" xDataReference="dg_2_1_0"
162         yDataReference="dg_2_0_0"/>
163       <curve id="plot_2__plot_2_0_1__plot_2_1_0" logX="false" logY="false" xDataReference="dg_2_0_1"
164         yDataReference="dg_2_1_0"/>
165     </listOfCurves>
166   </plot2D>
167 </listOfOutputs>
168 </sedML>

```

Listing A.1: *SED-ML document for example simulation experiment.*

A.2 Simulation experiments with dataDescriptions

The `DataDescription` provides means to use external datasets in simulation experiments. In this section simulation experiments using the `dataDescription` are presented.

A.2.1 Plotting data with simulations (L1V3_plotting-data-numl.omex)

This example demonstrates the use of the `DataDescription` and `DataSource` to load external data in SED-ML. In the example a `model` is simulated (using a `uniformTimeCourse` simulation) and the simulation results are plotted. In addition data is plotted using the `dataDescription` and `DataSource`, extracting the `S1` and `time` column from it and renders it. The listed example uses data encoded in `NuML` as `format` (`urn:sedml:format:numl`).

The corresponding example using `CSV` (`urn:sedml:format:csv`) as `format` to encode the data is available as `L1V3_plotting-data-csv.omex`.

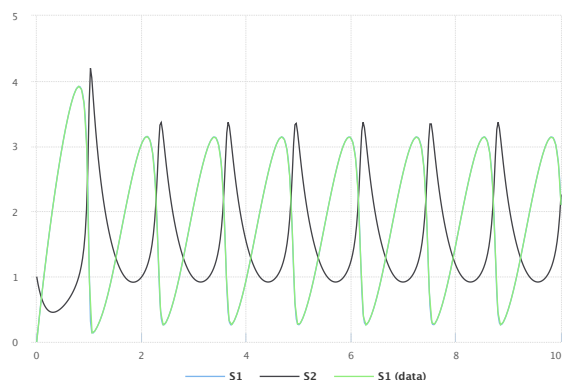

Figure A.1: The simulation result from the simulation description given in Listing A.2. Simulation with SED-ML web tools [2].

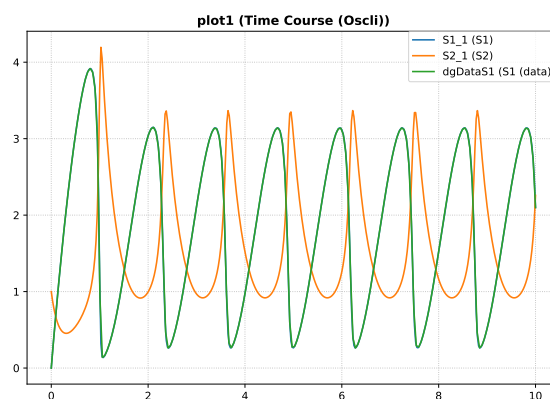

Figure A.2: Simulation with tellurium [5].

```
1 <?xml version="1.0" encoding="utf-8"?>
2 <sedML level="1" version="3" xmlns="http://sed-ml.org/sed-ml/level1/version3">
3   <listOfDataDescriptions>
4     <dataDescription id="Data1" name="oscillator data" source="./oscli.numl" format="
5       urn:sedml:format:numl">
6       <dimensionDescription>
7         <compositeDescription indexType="double" id="time" name="time" xmlns="http://www.numl.org
8           /numl/
9         level1/version1">
10          <compositeDescription indexType="string" id="SpeciesIds" name="SpeciesIds">
11            <atomicDescription valueType="double" name="Concentrations"/>
12          </compositeDescription>
13        </dimensionDescription>
14        <listOfDataSources>
15          <dataSource id="dataS1">
16            <listOfSlices>
17              <slice reference="SpeciesIds" value="S1"/>
18            </listOfSlices>
19          </dataSource>
20          <dataSource id="dataTime" indexSet="time"/>
21        </listOfDataSources>
22      </dataDescription>
23    </listOfDataDescriptions>
24    <listOfSimulations>
25      <uniformTimeCourse id="sim1" initialTime="0" outputStartTime="0" outputEndTime="10"
26        numberOfPoints="400">
27        <algorithm kisaoID="KISAO:0000019">
28          <listOfAlgorithmParameters>
29            <algorithmParameter kisaoID="KISAO:0000209" value="1E-06"/>
30            <algorithmParameter kisaoID="KISAO:0000211" value="1E-12"/>
31            <algorithmParameter kisaoID="KISAO:0000415" value="10000"/>
32          </listOfAlgorithmParameters>
33        </algorithm>
34      </uniformTimeCourse>
35    </listOfSimulations>
```

```

34 <listOfModels>
35   <model id="model1" language="urn:sedml:language:sbml" source="./oscli.xml"/>
36 </listOfModels>
37 <listOfTasks>
38   <task id="task1" modelReference="model1" simulationReference="sim1"/>
39 </listOfTasks>
40 <listOfDataGenerators>
41   <dataGenerator id="time_1" name="time">
42     <listOfVariables>
43       <variable id="time" name="time" taskReference="task1" symbol="urn:sedml:symbol:time"/>
44     </listOfVariables>
45     <math xmlns="http://www.w3.org/1998/Math/MathML">
46       <ci>time</ci>
47     </math>
48   </dataGenerator>
49   <dataGenerator id="S1_1" name="S1">
50     <listOfVariables>
51       <variable id="S1" name="S1" taskReference="task1"
52         target="/sbml:sbml/sbml:model/sbml:listOfSpecies/sbml:species[@id='S1']"/>
53     </listOfVariables>
54     <math xmlns="http://www.w3.org/1998/Math/MathML">
55       <ci>S1</ci>
56     </math>
57   </dataGenerator>
58   <dataGenerator id="S2_1" name="S2">
59     <listOfVariables>
60       <variable id="S2" name="S2" taskReference="task1"
61         target="/sbml:sbml/sbml:model/sbml:listOfSpecies/sbml:species[@id='S2']"/>
62     </listOfVariables>
63     <math xmlns="http://www.w3.org/1998/Math/MathML">
64       <ci>S2</ci>
65     </math>
66   </dataGenerator>
67   <dataGenerator id="dgDataS1" name="S1 (data)">
68     <listOfVariables>
69       <variable id="varS1" modelReference="model1" target="#dataS1"/>
70     </listOfVariables>
71     <math xmlns="http://www.w3.org/1998/Math/MathML">
72       <ci>varS1</ci>
73     </math>
74   </dataGenerator>
75   <dataGenerator id="dgDataTime" name="Time">
76     <listOfVariables>
77       <variable id="varTime" modelReference="model1" target="#dataTime"/>
78     </listOfVariables>
79     <math xmlns="http://www.w3.org/1998/Math/MathML">
80       <ci>varTime</ci>
81     </math>
82   </dataGenerator>
83 </listOfDataGenerators>
84 <listOfOutputs>
85   <plot2D id="plot1" name="Time Course (Oscili)">
86     <listOfCurves>
87       <curve id="curve1" logX="false" logY="false" xDataReference="time_1" yDataReference="S1_1"
88         />
89       <curve id="curve2" logX="false" logY="false" xDataReference="time_1" yDataReference="S2_1"
90         />
91       <curve id="curve3" logX="false" logY="false" xDataReference="dgDataTime" yDataReference="
92         dgDataS1"/>
93     </listOfCurves>
94   </plot2D>
95 </listOfOutputs>
96 </sedML>

```

Listing A.2: SED-ML document using *DataSource* and *DataDescription*

A.3 Simulation experiments with repeatedTasks

The `RepeatedTask` makes it possible to encode a large number of different simulation experiments. In this section several such simulation experiments are presented.

A.3.1 Time course parameter scan (L1V3_repeated-scan-oscli.omex)

In this example a `repeatedTask` is used to run repeated `uniformTimeCourse` simulations with a deterministic simulation algorithm. Within the `repeatedTask` after each run the parameter value is changed, resulting in a time course parameter scan.

NOTE: This example produces three dimensional results (time, species concentration, multiple repeats). SED-ML Level 1 Version 3 does not include a way to post-process these values, so it is left to the implementation on how to display them. One example would be to flatten the values by overlaying them onto the desired plot.

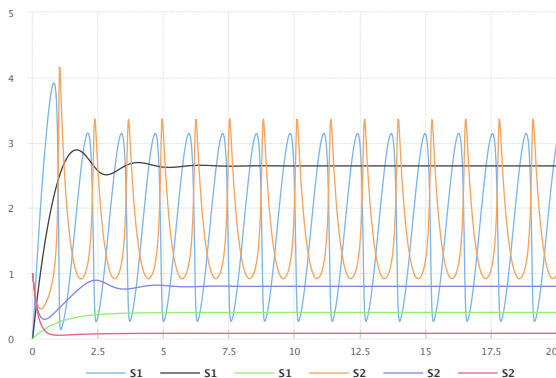

Figure A.3: The simulation result gained from the simulation description given in Listing A.3. Simulation with SED-ML web tools [2].

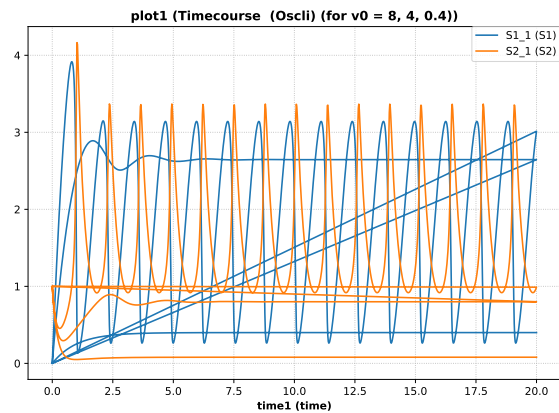

Figure A.4: Simulation with tellurium [5].

```

1 <?xml version="1.0" encoding="utf-8"?>
2 <sedML xmlns="http://sed-ml.org/sed-ml/level1/version3" level="1" version="3">
3   <listOfSimulations>
4     <uniformTimeCourse id="timecourse1" initialTime="0" outputStartTime="0" outputEndTime="20"
5       numberOfPoints="1000">
6       <algorithm kisaoID="KISA0:0000019" />
7     </uniformTimeCourse>
8   </listOfSimulations>
9   <listOfModels>
10    <model id="modell1" language="urn:sedml:language:sbml" source="./oscli.xml" />
11  </listOfModels>
12  <listOfTasks>
13    <task id="task0" modelReference="modell1" simulationReference="timecourse1" />
14    <repeatedTask id="task1" resetModel="true" range="current">
15      <listOfRanges>
16        <vectorRange id="current">
17          <value>8</value>
18          <value>4</value>
19          <value>0.4</value>
20        </vectorRange>
21      </listOfRanges>
22      <listOfChanges>
23        <setValue target="/sbml:sbml/sbml:model/sbml:listOfParameters/sbml:parameter[@id='J0_v0']"
24          range="current" modelReference="modell1">
25          <math xmlns="http://www.w3.org/1998/Math/MathML">
26            <ci> current </ci>
27          </math>
28        </setValue>
29      </listOfChanges>
30    </repeatedTask>
31  </listOfTasks>
32  <listOfDataGenerators>
33    <dataGenerator id="time1" name="time">

```

```

36     <listOfVariables>
37       <variable id="time" symbol="urn:sedml:symbol:time" taskReference="task1" />
38     </listOfVariables>
39     <math xmlns="http://www.w3.org/1998/Math/MathML">
40       <ci> time </ci>
41     </math>
42   </dataGenerator>
43   <dataGenerator id="J0_v0_1" name="J0_v0">
44     <listOfVariables>
45       <variable id="J0_v0" name="J0_v0" taskReference="task1" target="/sbml:sbml/sbml:model/
46         sbml:listOfParameters/sbml:parameter[@id='J0_v0']" />
47     </listOfVariables>
48     <math xmlns="http://www.w3.org/1998/Math/MathML">
49       <ci> J0_v0 </ci>
50     </math>
51   </dataGenerator>
52   <dataGenerator id="S1_1" name="S1">
53     <listOfVariables>
54       <variable id="S1" name="S1" taskReference="task1" target="/sbml:sbml/sbml:model/
55         sbml:listOfSpecies/sbml:species[@id='S1']" />
56     </listOfVariables>
57     <math xmlns="http://www.w3.org/1998/Math/MathML">
58       <ci> S1 </ci>
59     </math>
60   </dataGenerator>
61   <dataGenerator id="S2_1" name="S2">
62     <listOfVariables>
63       <variable id="S2" name="S2" taskReference="task1" target="/sbml:sbml/sbml:model/
64         sbml:listOfSpecies/sbml:species[@id='S2']" />
65     </listOfVariables>
66     <math xmlns="http://www.w3.org/1998/Math/MathML">
67       <ci> S2 </ci>
68     </math>
69   </dataGenerator>
70 </listOfDataGenerators>
71 <listOfOutputs>
72   <plot2D id="plot1" name="Timecourse (Oscili) (for v0 = 8, 4, 0.4)">
73     <listOfCurves>
74       <curve id="curve1" logX="false" logY="false" xDataReference="time1" yDataReference="S1_1" />
75       <curve id="curve2" logX="false" logY="false" xDataReference="time1" yDataReference="S2_1" />
76     </listOfCurves>
77   </plot2D>
78 </listOfOutputs>
79 </sedML>

```

Listing A.3: SED-ML document implementing the one dimensional time course parameter scan

A.3.2 Steady state parameter scan (L1V3_repeated-steady-scan-oscli.omex)

In this example a `repeatedTask` is used in combination with a `steadyState` simulation task (performing a steady state computation). On each repeat a parameter is varied resulting in a steady state parameter scan.

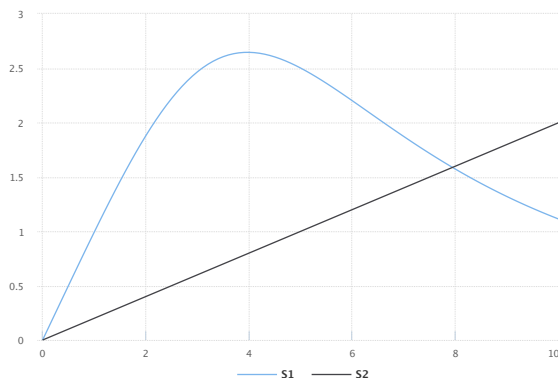

Figure A.5: The simulation result from the simulation description given in Listing A.4. Simulation with SED-ML web tools [2].

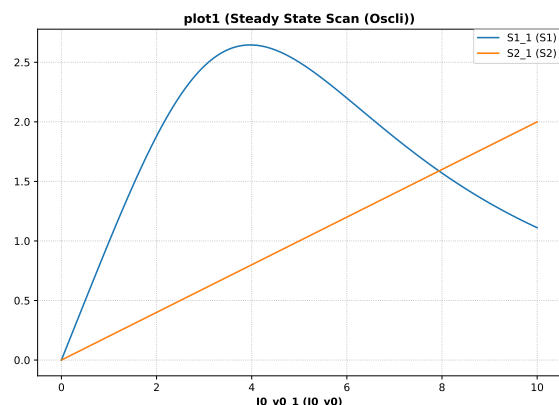

Figure A.6: Simulation with tellurium [5].

1 <?xml version="1.0" encoding="utf-8"?>

```

2 <!-- Written by libSedML v1.1.4992.38982 see http://libsedml.sf.net -->
3 <sedML xmlns="http://sed-ml.org/sed-ml/level1/version3" level="1" version="3">
4   <listOfSimulations>
5     <steadyState id="steady1">
6       <algorithm kisaoID="KISA0:0000282" />
7     </steadyState>
8   </listOfSimulations>
9   <listOfModels>
10    <model id="model1" language="urn:sedml:language:sbml" source="./oscli.xml" />
11  </listOfModels>
12  <listOfTasks>
13    <task id="task0" modelReference="model1" simulationReference="steady1" />
14    <repeatedTask id="task1" resetModel="true" range="current">
15      <listOfRanges>
16        <uniformRange id="current" start="0" end="10" numberOfPoints="100" type="linear" />
17      </listOfRanges>
18      <listOfChanges>
19        <setValue target="/sbml:sbml/sbml:model/sbml:listOfParameters/sbml:parameter[@id='J0_v0']"
20          range="current" modelReference="model1">
21          <math xmlns="http://www.w3.org/1998/Math/MathML">
22            <ci> current </ci>
23          </math>
24        </setValue>
25      </listOfChanges>
26      <listOfSubTasks>
27        <subTask order="1" task="task0" />
28      </listOfSubTasks>
29    </repeatedTask>
30  </listOfTasks>
31  <listOfDataGenerators>
32    <dataGenerator id="J0_v0_1" name="J0_v0">
33      <listOfVariables>
34        <variable id="J0_v0" name="J0_v0" taskReference="task1" target="/sbml:sbml/sbml:model/
35          sbml:listOfParameters/sbml:parameter[@id='J0_v0']" />
36      </listOfVariables>
37      <math xmlns="http://www.w3.org/1998/Math/MathML">
38        <ci> J0_v0 </ci>
39      </math>
40    </dataGenerator>
41    <dataGenerator id="S1_1" name="S1">
42      <listOfVariables>
43        <variable id="S1" name="S1" taskReference="task1" target="/sbml:sbml/sbml:model/
44          sbml:listOfSpecies/sbml:species[@id='S1']" />
45      </listOfVariables>
46      <math xmlns="http://www.w3.org/1998/Math/MathML">
47        <ci> S1 </ci>
48      </math>
49    </dataGenerator>
50    <dataGenerator id="S2_1" name="S2">
51      <listOfVariables>
52        <variable id="S2" name="S2" taskReference="task1" target="/sbml:sbml/sbml:model/
53          sbml:listOfSpecies/sbml:species[@id='S2']" />
54      </listOfVariables>
55      <math xmlns="http://www.w3.org/1998/Math/MathML">
56        <ci> S2 </ci>
57      </math>
58    </dataGenerator>
59  </listOfDataGenerators>
60  <listOfOutputs>
61    <plot2D id="plot1" name="Steady State Scan (Oscli)">
62      <listOfCurves>
63        <curve id="curve1" logX="false" logY="false" xDataReference="J0_v0_1" yDataReference="S1_1" />
64        <curve id="curve2" logX="false" logY="false" xDataReference="J0_v0_1" yDataReference="S2_1" />
65      </listOfCurves>
66    </plot2D>
67    <report id="report1" name="Steady State Values">
68      <listOfDataSets>
69        <dataSet id="col1" dataReference="J0_v0_1" label="J0_v0" />
70        <dataSet id="col2" dataReference="S1_1" label="S1" />
71        <dataSet id="col3" dataReference="S2_1" label="S2" />
72      </listOfDataSets>
73    </report>
74  </listOfOutputs>
75 </sedML>

```

Listing A.4: SED-ML document implementing the one dimensional steady state parameter scan

A.3.3 Stochastic simulation (L1V3_repeated-stochastic-runs.omex)

In this example a `repeatedTask` is used to run a stochastic simulation multiple times. Running just one stochastic trace does not provide a complete picture of the behavior of a system. A large number of such traces is needed. This example demonstrates the basic use case of running ten traces of a simulation by using a `repeatedTask` which runs ten uniform time course simulations (each performing a stochastic simulation).

NOTE: This example produces three dimensional results (time, species concentration, multiple repeats). While SED-ML Level 1 Version 3 does not include a way to post-processing these values. So it is left to the implementation on how to display them. One example would be to flatten the values by overlaying them onto the desired plot.

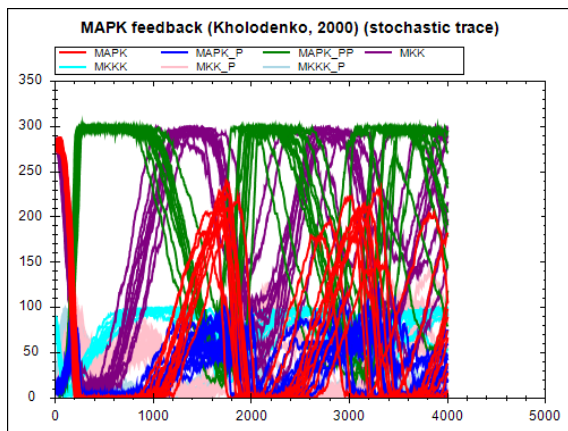

Figure A.7: The simulation result from the simulation description given in Listing A.5. Simulation with SED-ML web tools [2].

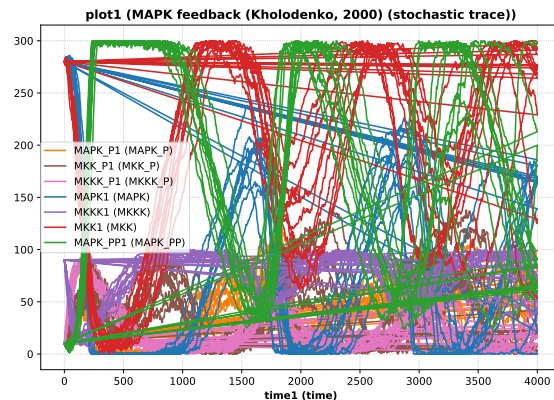

Figure A.8: Simulation with tellurium [5].

```

1 <?xml version="1.0" encoding="utf-8"?>
2 <sedML xmlns="http://sed-ml.org/sed-ml/level1/version3" level="1" version="3">
3   <listOfSimulations>
4     <uniformTimeCourse id="timecourse1" initialTime="0" outputStartTime="0" outputEndTime="4000"
5       numberOfPoints="1000">
6       <algorithm kisaoID="KISAO:0000241" />
7     </uniformTimeCourse>
8   </listOfSimulations>
9   <listOfModels>
10    <model id="modell" language="urn:sedml:language:sbml" source="./BorisEJB.xml" />
11  </listOfModels>
12  <listOfTasks>
13    <task id="task0" modelReference="modell" simulationReference="timecourse1" />
14    <repeatedTask id="task1" resetModel="true" range="current">
15      <listOfRanges>
16        <uniformRange id="current" start="0" end="10" numberOfPoints="10" type="linear" />
17      </listOfRanges>
18      <listOfSubTasks>
19        <subTask order="1" task="task0" />
20      </listOfSubTasks>
21    </repeatedTask>
22  </listOfTasks>
23  <listOfDataGenerators>
24    <dataGenerator id="time1" name="time">
25      <listOfVariables>
26        <variable id="time" taskReference="task1" symbol="urn:sedml:symbol:time" />
27      </listOfVariables>
28      <math xmlns="http://www.w3.org/1998/Math/MathML">
29        <ci> time </ci>
30      </math>
31    </dataGenerator>
32    <dataGenerator id="MAPK1" name="MAPK">
33      <listOfVariables>
34        <variable id="MAPK" name="MAPK" taskReference="task1" target="/sbml:sbml/sbml:model/
35          sbml:listOfSpecies/sbml:species[@id='MAPK']" />
36      </listOfVariables>
37      <math xmlns="http://www.w3.org/1998/Math/MathML">
38        <ci> MAPK </ci>
39      </math>
40    </dataGenerator>
41    <dataGenerator id="MAPK_P1" name="MAPK_P">
42      <listOfVariables>
43        <variable id="MAPK_P" name="MAPK_P" taskReference="task1" target="/sbml:sbml/sbml:model/
44          sbml:listOfSpecies/sbml:species[@id='MAPK_P']" />
45      </listOfVariables>
46      <math xmlns="http://www.w3.org/1998/Math/MathML">
47        <ci> MAPK_P </ci>
48      </math>
49    </dataGenerator>
50    <dataGenerator id="MAPK_PP1" name="MAPK_PP">
51      <listOfVariables>

```

```

49     <variable id="MAPK_PP" name="MAPK_PP" taskReference="task1" target="/sbml:sbml/sbml:model/
50         sbml:listOfSpecies/sbml:species[@id='MAPK_PP']" />
51 </listOfVariables>
52 <math xmlns="http://www.w3.org/1998/Math/MathML">
53     <ci> MAPK_PP </ci>
54 </math>
55 </dataGenerator>
56 <dataGenerator id="MKK1" name="MKK">
57     <listOfVariables>
58         <variable id="MKK" name="MKK" taskReference="task1" target="/sbml:sbml/sbml:model/
59             sbml:listOfSpecies/sbml:species[@id='MKK']" />
60     </listOfVariables>
61     <math xmlns="http://www.w3.org/1998/Math/MathML">
62         <ci> MKK </ci>
63     </math>
64 </dataGenerator>
65 <dataGenerator id="MKK_P1" name="MKK_P">
66     <listOfVariables>
67         <variable id="MKK_P" name="MKK_P" taskReference="task1" target="/sbml:sbml/sbml:model/
68             sbml:listOfSpecies/sbml:species[@id='MKK_P']" />
69     </listOfVariables>
70     <math xmlns="http://www.w3.org/1998/Math/MathML">
71         <ci> MKK_P </ci>
72     </math>
73 </dataGenerator>
74 <dataGenerator id="MKKK1" name="MKKK">
75     <listOfVariables>
76         <variable id="MKKK" name="MKKK" taskReference="task1" target="/sbml:sbml/sbml:model/
77             sbml:listOfSpecies/sbml:species[@id='MKKK']" />
78     </listOfVariables>
79     <math xmlns="http://www.w3.org/1998/Math/MathML">
80         <ci> MKKK </ci>
81     </math>
82 </dataGenerator>
83 <dataGenerator id="MKKK_P1" name="MKKK_P">
84     <listOfVariables>
85         <variable id="MKKK_P" name="MKKK_P" taskReference="task1" target="/sbml:sbml/sbml:model/
86             sbml:listOfSpecies/sbml:species[@id='MKKK_P']" />
87     </listOfVariables>
88     <math xmlns="http://www.w3.org/1998/Math/MathML">
89         <ci> MKKK_P </ci>
90     </math>
91 </dataGenerator>
92 </listOfDataGenerators>
93 <listOfOutputs>
94     <plot2D id="plot1" name="MAPK feedback (Kholodenko, 2000) (stochastic trace)">
95         <listOfCurves>
96             <curve id="curve1" logX="false" logY="false" xDataReference="time1" yDataReference="MAPK1" />
97             <curve id="curve2" logX="false" logY="false" xDataReference="time1" yDataReference="MAPK_P1" />
98             <curve id="curve3" logX="false" logY="false" xDataReference="time1" yDataReference="MAPK_PP1" />
99             <curve id="curve4" logX="false" logY="false" xDataReference="time1" yDataReference="MKK1" />
100             <curve id="curve5" logX="false" logY="false" xDataReference="time1" yDataReference="MKKK1" />
101             <curve id="curve6" logX="false" logY="false" xDataReference="time1" yDataReference="MKK_P1" />
102             <curve id="curve7" logX="false" logY="false" xDataReference="time1" yDataReference="MKKK_P1" />
103         </listOfCurves>
104     </plot2D>
105 </listOfOutputs>
106 </sedML>

```

Listing A.5: SED-ML document implementing repeated stochastic runs

A.3.4 Simulation perturbation (L1V3_oscli-nested-pulse.omex)

Often it is interesting to see how the dynamic behavior of a model changes when some perturbations are applied to the model. In this example a `repeatedTask` is used iterating a `oneStep` task (that advances an ODE integration to the next output step). During the steps a single parameter is modified effectively causing the oscillations of a model to stop. Once the value is reset the oscillations recover.

Note: In the example a `functionalRange` is used, although the same result could also be achieved using the `setValue` element directly.

```

1 <?xml version="1.0" encoding="utf-8"?>
2 <sedML xmlns="http://sed-ml.org/sed-ml/level1/version3" level="1" version="3">
3     <listOfSimulations>
4         <oneStep id="stepper" step="0.1">
5             <algorithm kisaoID="KISAO:0000019" />
6         </oneStep>
7     </listOfSimulations>
8     <listOfModels>
9         <model id="model1" language="urn:sedml:language:sbml" source="./oscli.xml" />
10    </listOfModels>
11    <listOfTasks>
12        <task id="task0" modelReference="model1" simulationReference="stepper" />
13        <repeatedTask id="task1" resetModel="false" range="index">

```

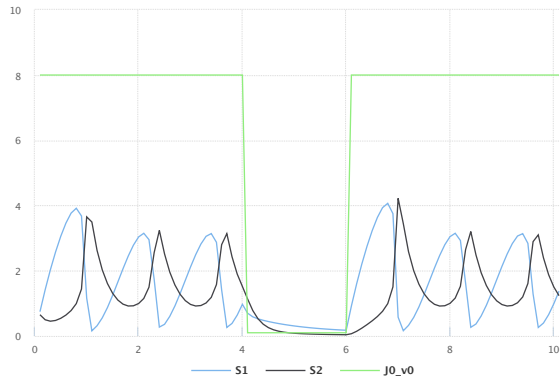

Figure A.9: The simulation result from the simulation description given in Listing A.6. Simulation with SED-ML web tools [2].

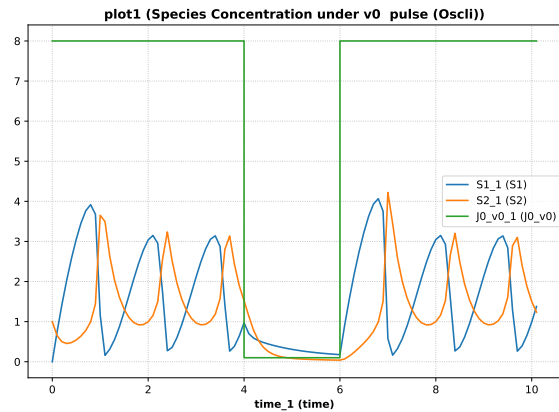

Figure A.10: Simulation with tellurium [5].

```

14     <listOfRanges>
15       <uniformRange id="index" start="0" end="10" numberOfPoints="100" type="linear" />
16       <functionalRange id="current" range="index">
17         <math xmlns="http://www.w3.org/1998/Math/MathML">
18           <piecewise>
19             <piece>
20               <cn> 8 </cn>
21               <apply>
22                 <lt />
23                 <ci> index </ci>
24                 <cn> 1 </cn>
25               </apply>
26             </piece>
27             <piece>
28               <cn> 0.1 </cn>
29               <apply>
30                 <and />
31                 <apply>
32                   <geq />
33                   <ci> index </ci>
34                   <cn> 4 </cn>
35                 </apply>
36                 <apply>
37                   <lt />
38                   <ci> index </ci>
39                   <cn> 6 </cn>
40                 </apply>
41               </apply>
42             </piece>
43             <otherwise>
44               <cn> 8 </cn>
45             </otherwise>
46           </piecewise>
47         </math>
48       </functionalRange>
49     </listOfRanges>
50     <listOfChanges>
51       <setValue target="/sbml:sbml/sbml:model/sbml:listOfParameters/sbml:parameter[@id='J0_v0']"
52         range="current" modelReference="model1">
53         <math xmlns="http://www.w3.org/1998/Math/MathML">
54           <ci> current </ci>
55         </math>
56       </setValue>
57     </listOfChanges>
58     <listOfSubTasks>
59       <subTask order="1" task="task0" />
60     </listOfSubTasks>
61   </repeatedTask>
62 </listOfTasks>
63 <listOfDataGenerators>
64   <dataGenerator id="time_1" name="time">
65     <listOfVariables>
66       <variable id="time" symbol="urn:sedml:symbol:time" taskReference="task1" />
67     </listOfVariables>
68     <math xmlns="http://www.w3.org/1998/Math/MathML">
69       <ci> time </ci>
70     </math>
71   </dataGenerator>
72   <dataGenerator id="J0_v0_1" name="J0_v0">

```

```

73     <listOfVariables>
74       <variable id="J0_v0" name="J0_v0" taskReference="task1" target="/sbml:sbml/sbml:model/
       sbml:listOfParameters/sbml:parameter[@id='J0_v0']" />
75     </listOfVariables>
76     <math xmlns="http://www.w3.org/1998/Math/MathML">
77       <ci> J0_v0 </ci>
78     </math>
79   </dataGenerator>
80   <dataGenerator id="S1_1" name="S1">
81     <listOfVariables>
82       <variable id="S1" name="S1" taskReference="task1" target="/sbml:sbml/sbml:model/
       sbml:listOfSpecies/sbml:species[@id='S1']" />
83     </listOfVariables>
84     <math xmlns="http://www.w3.org/1998/Math/MathML">
85       <ci> S1 </ci>
86     </math>
87   </dataGenerator>
88   <dataGenerator id="S2_1" name="S2">
89     <listOfVariables>
90       <variable id="S2" name="S2" taskReference="task1" target="/sbml:sbml/sbml:model/
       sbml:listOfSpecies/sbml:species[@id='S2']" />
91     </listOfVariables>
92     <math xmlns="http://www.w3.org/1998/Math/MathML">
93       <ci> S2 </ci>
94     </math>
95   </dataGenerator>
96 </listOfDataGenerators>
97 <listOfOutputs>
98   <plot2D id="plot1" name="Species Concentration under v0 pulse (Oscili)">
99     <listOfCurves>
100       <curve id="curve1" logX="false" logY="false" xDataReference="time_1" yDataReference="S1_1" />
101       <curve id="curve2" logX="false" logY="false" xDataReference="time_1" yDataReference="S2_1" />
102       <curve id="curve3" logX="false" logY="false" xDataReference="time_1" yDataReference="J0_v0_1" />
103     </listOfCurves>
104   </plot2D>
105   <report id="report1" name="Species Concentration under v0 pulse (Oscili)">
106     <listOfDataSets>
107       <dataSet id="col0" dataReference="time_1" label="time" />
108       <dataSet id="col1" dataReference="J0_v0_1" label="J0_v0" />
109       <dataSet id="col2" dataReference="S1_1" label="S1" />
110       <dataSet id="col3" dataReference="S2_1" label="S2" />
111     </listOfDataSets>
112   </report>
113 </listOfOutputs>
114 </sedML>

```

Listing A.6: SED-ML document implementing the perturbation experiment

A.3.5 2D steady state parameter scan (L1V3_parameter-scan-2d.omex)

This example uses a [repeatedTask](#) which runs over another [repeatedTask](#) which performs a steady state computation. Each repeated simulation task modifies a different parameter.

NOTE: This example produces three dimensional results (time, species concentration, multiple repeats). While SED-ML Level 1 Version 3 does not include a way to post-processing these values. So it is left to the implementation on how to display them. One example would be to flatten the values by overlaying them onto the desired plot.

```

1 <?xml version="1.0" encoding="utf-8"?>
2 <sedML xmlns="http://sed-ml.org/sed-ml/level1/version3" level="1" version="3">
3   <listOfSimulations>
4     <steadyState id="steady1">
5       <algorithm kisaoID="KISA0:0000282" />
6     </steadyState>
7   </listOfSimulations>
8   <listOfModels>
9     <model id="model1" language="urn:sedml:language:sbml" source="BorisEJB.xml" />
10  </listOfModels>
11  <listOfTasks>
12    <task id="task0" modelReference="model1" simulationReference="steady1" />
13    <repeatedTask id="task1" resetModel="false" range="current">
14      <listOfRanges>
15        <vectorRange id="current">
16          <value>1</value>
17          <value>5</value>
18          <value>10</value>
19          <value>50</value>
20          <value>60</value>
21          <value>70</value>
22          <value>80</value>
23          <value>90</value>
24          <value>100</value>
25        </vectorRange>
26      </listOfRanges>

```

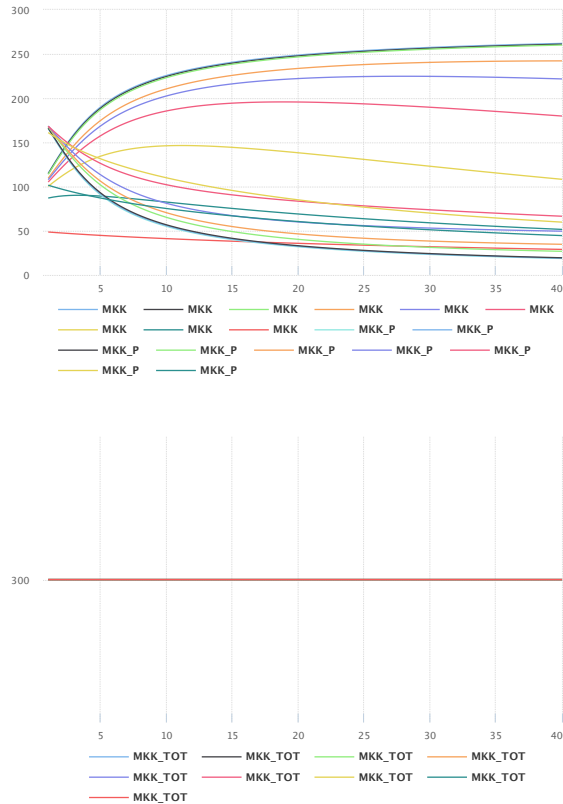

Figure A.11: The simulation result gained from the simulation description given in Listing A.7. Simulation with SED-ML web tools [2].

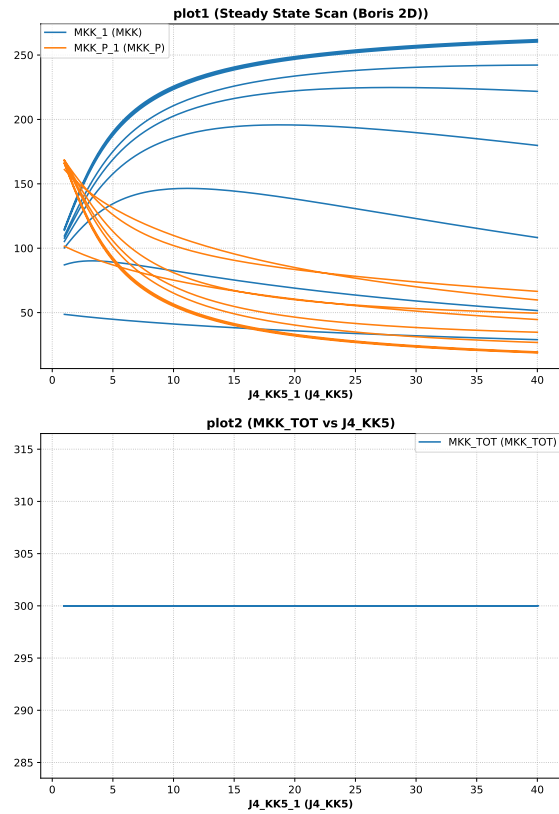

Figure A.12: Simulation with tellurium [5].

```

27 <listOfChanges>
28   <setValue target="/sbml:sbml/sbml:model/sbml:listOfParameters/sbml:parameter[@id='J1_KK2']"
29     range="current" modelReference="model1">
30     <math xmlns="http://www.w3.org/1998/Math/MathML">
31       <ci> current </ci>
32     </math>
33   </setValue>
34 </listOfChanges>
35 <listOfSubTasks>
36   <subTask order="1" task="task2" />
37 </listOfSubTasks>
38 </repeatedTask>
39 <repeatedTask id="task2" resetModel="false" range="current1">
40   <listOfRanges>
41     <uniformRange id="current1" start="1" end="40" numberOfPoints="100" type="linear" />
42   </listOfRanges>
43   <listOfChanges>
44     <setValue target="/sbml:sbml/sbml:model/sbml:listOfParameters/sbml:parameter[@id='J4_KK5']"
45       range="current1" modelReference="model1">
46       <math xmlns="http://www.w3.org/1998/Math/MathML">
47         <ci> current1 </ci>
48       </math>
49     </setValue>
50   </listOfChanges>
51   <listOfSubTasks>
52     <subTask order="1" task="task0" />
53   </listOfSubTasks>
54 </repeatedTask>
55 </listOfTasks>
56 <listOfDataGenerators>
57   <dataGenerator id="J4_KK5_1" name="J4_KK5">
58     <listOfVariables>
59       <variable id="J4_KK5" name="J4_KK5" taskReference="task1" target="/sbml:sbml/sbml:model/
60         sbml:listOfParameters/sbml:parameter[@id='J4_KK5']" />
61     </listOfVariables>
62     <math xmlns="http://www.w3.org/1998/Math/MathML">
63       <ci> J4_KK5 </ci>
64     </math>
65   </dataGenerator>

```

```

65 <dataGenerator id="J1_KK2_1" name="J1_KK2">
66 <listOfVariables>
67 <variable id="J1_KK2" name="J1_KK2" taskReference="task1" target="/sbml:sbml/sbml:model/
sbml:listOfParameters/sbml:parameter[@id='J1_KK2']" />
68 </listOfVariables>
69 <math xmlns="http://www.w3.org/1998/Math/MathML">
70 <ci> J1_KK2 </ci>
71 </math>
72 </dataGenerator>
73 <dataGenerator id="MKK_1" name="MKK">
74 <listOfVariables>
75 <variable id="MKK" name="MKK" taskReference="task1" target="/sbml:sbml/sbml:model/
sbml:listOfSpecies/sbml:species[@id='MKK']" />
76 </listOfVariables>
77 <math xmlns="http://www.w3.org/1998/Math/MathML">
78 <ci> MKK </ci>
79 </math>
80 </dataGenerator>
81 <dataGenerator id="MKK_P_1" name="MKK_P">
82 <listOfVariables>
83 <variable id="MKK_P" name="MKK_P" taskReference="task1" target="/sbml:sbml/sbml:model/
sbml:listOfSpecies/sbml:species[@id='MKK_P']" />
84 </listOfVariables>
85 <math xmlns="http://www.w3.org/1998/Math/MathML">
86 <ci> MKK_P </ci>
87 </math>
88 </dataGenerator>
89 <dataGenerator id="MKK_PP_1" name="MKK_PP_1">
90 <listOfVariables>
91 <variable id="MKK_PP_1" name="MKK_PP" taskReference="task1" target="/sbml:sbml/sbml:model/
sbml:listOfSpecies/sbml:species[@id='MKK_PP']" />
92 </listOfVariables>
93 <math xmlns="http://www.w3.org/1998/Math/MathML">
94 <ci> MKK_PP_1 </ci>
95 </math>
96 </dataGenerator>
97 <dataGenerator id="MKK_TOT" name="MKK_TOT">
98 <listOfVariables>
99 <variable id="MKK" name="MKK" taskReference="task1" target="/sbml:sbml/sbml:model/
sbml:listOfSpecies/sbml:species[@id='MKK']" />
100 <variable id="MKK_P" name="MKK_P" taskReference="task1" target="/sbml:sbml/sbml:model/
sbml:listOfSpecies/sbml:species[@id='MKK_P']" />
101 <variable id="MKK_PP" name="MKK_PP" taskReference="task1" target="/sbml:sbml/sbml:model/
sbml:listOfSpecies/sbml:species[@id='MKK_PP']" />
102 </listOfVariables>
103 <math xmlns="http://www.w3.org/1998/Math/MathML">
104 <apply>
105 <plus/>
106 <ci> MKK </ci>
107 <ci> MKK_P </ci>
108 <ci> MKK_PP </ci>
109 </apply>
110 </math>
111 </dataGenerator>
112 </listOfDataGenerators>
113 <listOfOutputs>
114 <plot2D id="plot1" name="Steady State Scan (Boris 2D)">
115 <listOfCurves>
116 <curve id="curve1" logX="false" logY="false" xDataReference="J4_KK5_1" yDataReference="MKK_1" />
117 <curve id="curve2" logX="false" logY="false" xDataReference="J4_KK5_1" yDataReference="MKK_P_1" />
118 </listOfCurves>
119 </plot2D>
120 <plot2D id="plot2" name="MKK_TOT vs J4_KK5">
121 <listOfCurves>
122 <curve id="curve3" logX="false" logY="false" xDataReference="J4_KK5_1" yDataReference="MKK_TOT" />
123 </listOfCurves>
124 </plot2D>
125 <report id="report1" name="Steady State Values (Boris2D)">
126 <listOfDataSets>
127 <dataSet id="col0" dataReference="J4_KK5_1" label="J4_KK5" />
128 <dataSet id="col1" dataReference="J1_KK2_1" label="J1_KK2" />
129 <dataSet id="col2" dataReference="MKK_1" label="MKK" />
130 <dataSet id="col3" dataReference="MKK_P_1" label="MKK_P" />
131 <dataSet id="col_4" dataReference="MKK_PP_1" label="MKK_PP_1" />
132 <dataSet id="col4" dataReference="MKK_TOT" label="MKK_TOT" />
133 </listOfDataSets>
134 </report>
135 </listOfOutputs>
136 </sedML>

```

Listing A.7: SED-ML document implementing the two dimensional steady state parameter scan

A.4 Simulation experiments with different model languages

SED-ML allows to specify models in various languages, e.g., SBML [14] and CellML [8] (see Section 3.2.3 for more information). This section demonstrates the same simulation experiment with the model either in SBML (Appendix A.4.1) or in CellML (Appendix A.4.2).

A.4.1 Van der Pol oscillator in SBML (L1V3_vanderpol-sbml.omex)

The following example provides a SED-ML description for the simulation of the Van der Pol oscillator in SBML [14]. The time-course and the behavior in the phase plane are plotted. The mathematical model and the performed simulation experiment are identical to Appendix A.4.2.

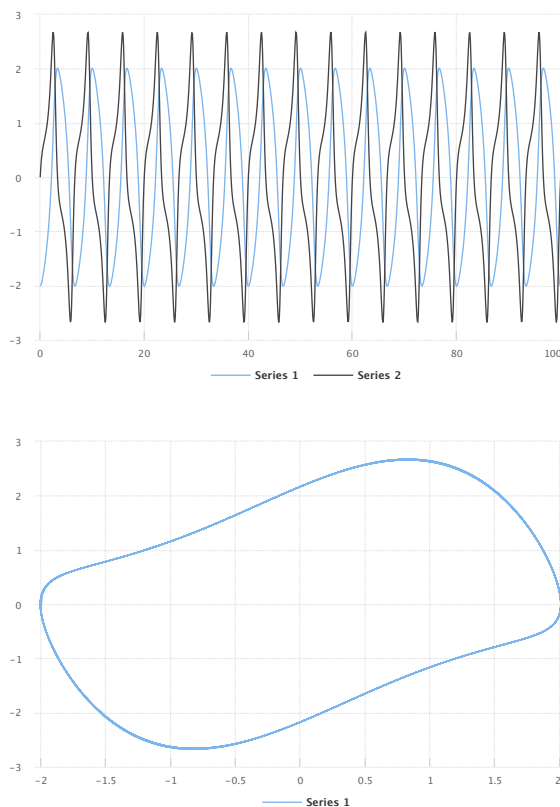

Figure A.13: The simulation result gained from the simulation description given in Listing A.8. Simulation with SED-ML web tools [2].

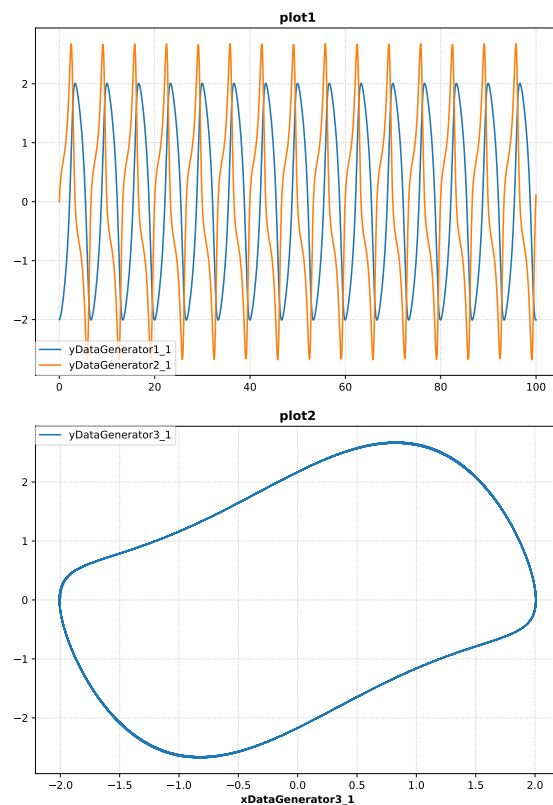

Figure A.14: Simulation with tellurium [5].

```

1 <?xml version='1.0' encoding='UTF-8'?>
2 <sedML level="1" version="3" xmlns="http://sed-ml.org/sed-ml/level1/version3">
3   <listOfSimulations>
4     <uniformTimeCourse id="simulation1" initialTime="0" numberOfPoints="1000" outputEndTime="100"
5       outputStartTime="0">
6       <algorithm kisaoID="KISAO:0000019">
7         <listOfAlgorithmParameters>
8           <algorithmParameter kisaoID="KISAO:0000211" value="1e-07"/>
9           <algorithmParameter kisaoID="KISAO:0000475" value="BDF"/>
10          <algorithmParameter kisaoID="KISAO:0000481" value="true"/>
11          <algorithmParameter kisaoID="KISAO:0000476" value="Newton"/>
12          <algorithmParameter kisaoID="KISAO:0000477" value="Dense"/>
13          <algorithmParameter kisaoID="KISAO:0000480" value="0"/>
14          <algorithmParameter kisaoID="KISAO:0000415" value="500"/>
15          <algorithmParameter kisaoID="KISAO:0000467" value="0"/>
16          <algorithmParameter kisaoID="KISAO:0000478" value="Banded"/>
17          <algorithmParameter kisaoID="KISAO:0000209" value="1e-07"/>
18          <algorithmParameter kisaoID="KISAO:0000479" value="0"/>
19        </listOfAlgorithmParameters>
20      </algorithm>

```

```

20     </uniformTimeCourse>
21 </listOfSimulations>
22 <listOfModels>
23   <model id="model" language="urn:sedml:language:sbml" source="vanderpol-sbml.xml"/>
24 </listOfModels>
25 <listOfTasks>
26   <repeatedTask id="repeatedTask" range="once" resetModel="true">
27     <listOfRanges>
28       <vectorRange id="once">
29         <value> 1 </value>
30       </vectorRange>
31     </listOfRanges>
32     <listOfSubTasks>
33       <subTask order="1" task="task1"/>
34     </listOfSubTasks>
35   </repeatedTask>
36   <task id="task1" modelReference="model" simulationReference="simulation1"/>
37 </listOfTasks>
38 <listOfDataGenerators>
39   <dataGenerator id="xDataGenerator1_1">
40     <listOfVariables>
41       <variable id="xVariable1_1" taskReference="task1" symbol="urn:sedml:symbol:time" />
42     </listOfVariables>
43     <math xmlns="http://www.w3.org/1998/Math/MathML">
44       <ci> xVariable1_1 </ci>
45     </math>
46   </dataGenerator>
47   <dataGenerator id="yDataGenerator1_1">
48     <listOfVariables>
49       <variable id="yVariable1_1" target="/sbml:sbml/sbml:model/sbml:listOfSpecies/sbml:species
50         [id='x']" taskReference="repeatedTask" modelReference="model"/>
51     </listOfVariables>
52     <math xmlns="http://www.w3.org/1998/Math/MathML">
53       <ci> yVariable1_1 </ci>
54     </math>
55   </dataGenerator>
56   <dataGenerator id="xDataGenerator2_1">
57     <listOfVariables>
58       <variable id="xVariable2_1" taskReference="task1" symbol="urn:sedml:symbol:time" />
59     </listOfVariables>
60     <math xmlns="http://www.w3.org/1998/Math/MathML">
61       <ci> xVariable2_1 </ci>
62     </math>
63   </dataGenerator>
64   <dataGenerator id="yDataGenerator2_1">
65     <listOfVariables>
66       <variable id="yVariable2_1" target="/sbml:sbml/sbml:model/sbml:listOfSpecies/sbml:species
67         [id='y']" taskReference="repeatedTask" modelReference="model"/>
68     </listOfVariables>
69     <math xmlns="http://www.w3.org/1998/Math/MathML">
70       <ci> yVariable2_1 </ci>
71     </math>
72   </dataGenerator>
73   <dataGenerator id="xDataGenerator3_1">
74     <listOfVariables>
75       <variable id="xVariable3_1" target="/sbml:sbml/sbml:model/sbml:listOfSpecies/sbml:species
76         [id='x']" taskReference="repeatedTask" modelReference="model"/>
77     </listOfVariables>
78     <math xmlns="http://www.w3.org/1998/Math/MathML">
79       <ci> xVariable3_1 </ci>
80     </math>
81   </dataGenerator>
82   <dataGenerator id="yDataGenerator3_1">
83     <listOfVariables>
84       <variable id="yVariable3_1" target="/sbml:sbml/sbml:model/sbml:listOfSpecies/sbml:species
85         [id='y']" taskReference="repeatedTask" modelReference="model"/>
86     </listOfVariables>
87     <math xmlns="http://www.w3.org/1998/Math/MathML">
88       <ci> yVariable3_1 </ci>
89     </math>
90   </dataGenerator>
91 </listOfDataGenerators>
92 <listOfOutputs>
93   <plot2D id="plot1">
94     <listOfCurves>
95       <curve id="curve1_1" logX="false" logY="false" xDataReference="xDataGenerator1_1"
96         yDataReference="yDataGenerator1_1"/>
97       <curve id="curve2_1" logX="false" logY="false" xDataReference="xDataGenerator2_1"
98         yDataReference="yDataGenerator2_1"/>
99     </listOfCurves>
100   </plot2D>
101   <plot2D id="plot2">
102     <listOfCurves>
103       <curve id="curve3_1" logX="false" logY="false" xDataReference="xDataGenerator3_1"
104         yDataReference="yDataGenerator3_1"/>
105     </listOfCurves>
106   </plot2D>
107 </listOfOutputs>

```

Listing A.8: *Van der Pol Model (SBML) Simulation Description in SED-ML***A.4.2 Van der Pol oscillator in CellML (L1V3_vanderpol-cellml.omex)**

The following example provides a SED-ML description for the simulation of the Van der Pol model in CellML [8]. The time-course and the behavior in the phase plane are plotted. The mathematical model and the performed simulation experiment are identical to Appendix A.4.1.

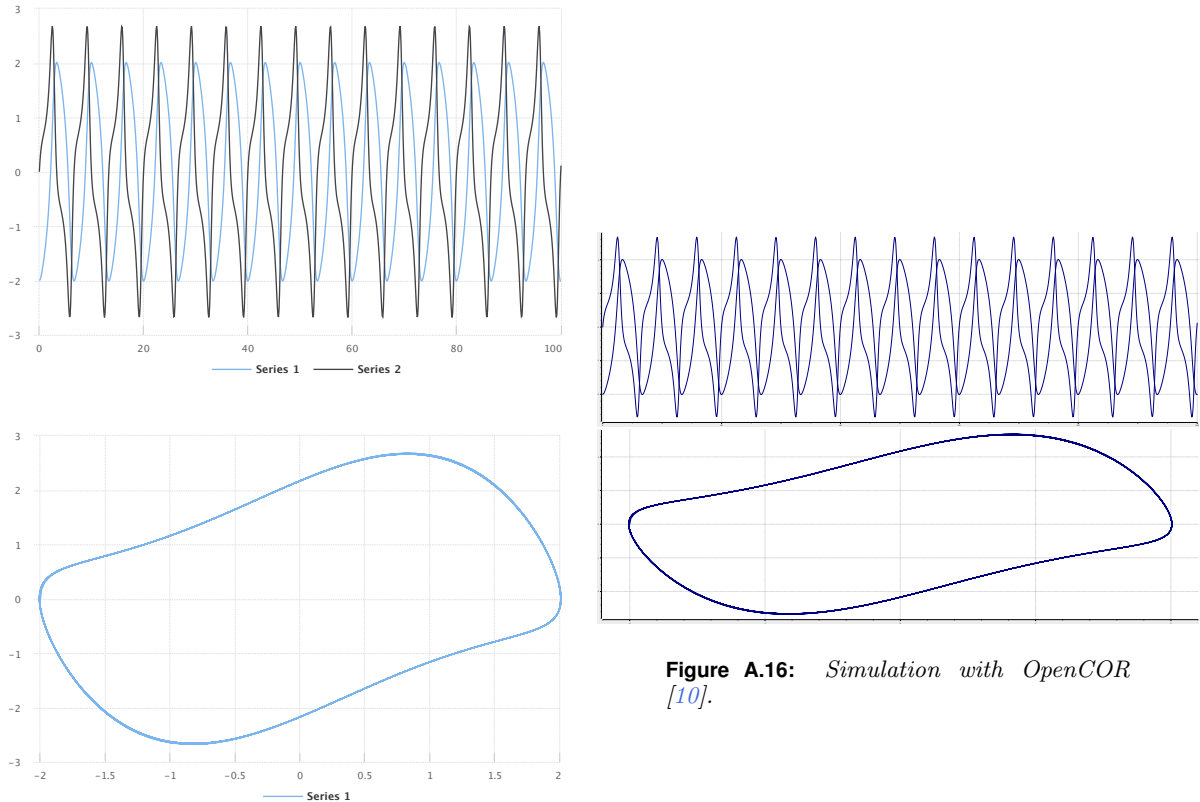

Figure A.16: *Simulation with OpenCOR [10].*

Figure A.15: *The simulation result gained from the simulation description given in Listing A.9. Simulation with SED-ML web tools [2].*

```

1 <?xml version='1.0' encoding='UTF-8'?>
2 <sedML level="1" version="3" xmlns="http://sed-ml.org/sed-ml/level1/version3" xmlns:cellml="http://www.
  cellml.org/cellml/1.0#">
3   <listOfSimulations>
4     <uniformTimeCourse id="simulation1" initialTime="0" numberOfPoints="1000" outputEndTime="100"
      outputStartTime="0">
5       <algorithm kisaoID="KISAO:0000019">
6         <listOfAlgorithmParameters>
7           <algorithmParameter kisaoID="KISAO:0000211" value="1e-07"/>
8           <algorithmParameter kisaoID="KISAO:0000475" value="BDF"/>
9           <algorithmParameter kisaoID="KISAO:0000481" value="true"/>
10          <algorithmParameter kisaoID="KISAO:0000476" value="Newton"/>
11          <algorithmParameter kisaoID="KISAO:0000477" value="Dense"/>
12          <algorithmParameter kisaoID="KISAO:0000480" value="0"/>
13          <algorithmParameter kisaoID="KISAO:0000415" value="500"/>
14          <algorithmParameter kisaoID="KISAO:0000467" value="0"/>
15          <algorithmParameter kisaoID="KISAO:0000478" value="Banded"/>
16          <algorithmParameter kisaoID="KISAO:0000209" value="1e-07"/>
17          <algorithmParameter kisaoID="KISAO:0000479" value="0"/>
18        </listOfAlgorithmParameters>
19      </algorithm>
20    </uniformTimeCourse>
21  </listOfSimulations>
22  </listOfModels>

```

```

23     <model id="model" language="urn:sedml:language:cellml.1.0" source="vanderpol-model.cellml"/>
24 </listOfModels>
25 <listOfTasks>
26   <repeatedTask id="repeatedTask" range="once" resetModel="true">
27     <listOfRanges>
28       <vectorRange id="once">
29         <value> 1 </value>
30       </vectorRange>
31     </listOfRanges>
32     <listOfSubTasks>
33       <subTask order="1" task="task1"/>
34     </listOfSubTasks>
35   </repeatedTask>
36   <task id="task1" modelReference="model" simulationReference="simulation1"/>
37 </listOfTasks>
38 <listOfDataGenerators>
39   <dataGenerator id="xDataGenerator1_1">
40     <listOfVariables>
41       <variable id="xVariable1_1" target="/cellml:model/cellml:component[@name='main']/
42         cellml:variable[@name='t']" taskReference="repeatedTask"/>
43     </listOfVariables>
44     <math xmlns="http://www.w3.org/1998/Math/MathML">
45       <ci> xVariable1_1 </ci>
46     </math>
47   </dataGenerator>
48   <dataGenerator id="yDataGenerator1_1">
49     <listOfVariables>
50       <variable id="yVariable1_1" target="/cellml:model/cellml:component[@name='main']/
51         cellml:variable[@name='x']" taskReference="repeatedTask"/>
52     </listOfVariables>
53     <math xmlns="http://www.w3.org/1998/Math/MathML">
54       <ci> yVariable1_1 </ci>
55     </math>
56   </dataGenerator>
57   <dataGenerator id="xDataGenerator2_1">
58     <listOfVariables>
59       <variable id="xVariable2_1" target="/cellml:model/cellml:component[@name='main']/
60         cellml:variable[@name='t']" taskReference="repeatedTask"/>
61     </listOfVariables>
62     <math xmlns="http://www.w3.org/1998/Math/MathML">
63       <ci> xVariable2_1 </ci>
64     </math>
65   </dataGenerator>
66   <dataGenerator id="yDataGenerator2_1">
67     <listOfVariables>
68       <variable id="yVariable2_1" target="/cellml:model/cellml:component[@name='main']/
69         cellml:variable[@name='y']" taskReference="repeatedTask"/>
70     </listOfVariables>
71     <math xmlns="http://www.w3.org/1998/Math/MathML">
72       <ci> yVariable2_1 </ci>
73     </math>
74   </dataGenerator>
75   <dataGenerator id="xDataGenerator3_1">
76     <listOfVariables>
77       <variable id="xVariable3_1" target="/cellml:model/cellml:component[@name='main']/
78         cellml:variable[@name='x']" taskReference="repeatedTask"/>
79     </listOfVariables>
80     <math xmlns="http://www.w3.org/1998/Math/MathML">
81       <ci> xVariable3_1 </ci>
82     </math>
83   </dataGenerator>
84   <dataGenerator id="yDataGenerator3_1">
85     <listOfVariables>
86       <variable id="yVariable3_1" target="/cellml:model/cellml:component[@name='main']/
87         cellml:variable[@name='y']" taskReference="repeatedTask"/>
88     </listOfVariables>
89     <math xmlns="http://www.w3.org/1998/Math/MathML">
90       <ci> yVariable3_1 </ci>
91     </math>
92   </dataGenerator>
93 </listOfDataGenerators>
94 <listOfOutputs>
95   <plot2D id="plot1">
96     <listOfCurves>
97       <curve id="curve1_1" logX="false" logY="false" xDataReference="xDataGenerator1_1"
98         yDataReference="yDataGenerator1_1"/>
99       <curve id="curve2_1" logX="false" logY="false" xDataReference="xDataGenerator2_1"
100        yDataReference="yDataGenerator2_1"/>
101     </listOfCurves>
102   </plot2D>
103   <plot2D id="plot2">
104     <listOfCurves>
105       <curve id="curve3_1" logX="false" logY="false" xDataReference="xDataGenerator3_1"
106        yDataReference="yDataGenerator3_1"/>
107     </listOfCurves>
108   </plot2D>
109 </listOfOutputs>

```

101 </sedML>

Listing A.9: *Van der Pol Model (CellML) Simulation Description in SED-ML*

A.5 Reproducing publication results

SED-ML allows to describe simulation experiments from publications in a reproducible manner. This section provides such examples.

A.5.1 Le Loup model (L1V3_leloup-sbml.omex)

The following example provides a SED-ML description for the simulation of the model based on the publication [16].

The model is referenced by its SED-ML `id` `model1` and refers to the model with the MIRIAM URN `urn:miriam:biomodels.db:BIOMD0000000021`. A second model is defined in the example, using `model1` as a source and applying additional changes to it, in this case updating two model parameters.

One simulation setup is defined in the `listOfSimulations`. It is a `uniformTimeCourse` over 380 time units, providing 1000 output points. The algorithm used is the CVODE solver, as denoted by the KiSAO ID `KiSAO:0000019`.

A number of `dataGenerators` are defined, which are the prerequisite for defining the simulation `output`. The first `dataGenerator` with `id` `time` collects the simulation time. `tim1` maps on the `Mt` entity in the model that is used in `task1` which in the model `model1`. The `dataGenerator` named `per_tim1` maps on the `Cn` entity in `model1`. Finally the fourth and fifth `dataGenerators` map on the `Mt` and `per_tim` entity respectively in the updated model with ID `model2`.

The `output` defined in the experiment consists of three `2D plots`. The first plot has two `curves` and provides the time course of the simulation using the `tim` mRNA concentrations from both tasks. The second plot shows the `per_tim` concentration against the `tim` concentration for the oscillating model. The third plot shows the same plot for the chaotic model. The resulting three plots are depicted in Figure A.17 and A.18 .

```
1 <?xml version="1.0" encoding="utf-8"?>
2 <sedML xmlns="http://sed-ml.org/sed-ml/level1/version3" level="1" version="3">
3   <listOfSimulations>
4     <uniformTimeCourse id="simulation1" initialTime="0" outputStartTime="0" outputEndTime="380"
5       numberOfPoints="1000">
6       <algorithm kisaoID="KISA0:0000019" />
7     </uniformTimeCourse>
8   </listOfSimulations>
9   <listOfModels>
10    <model id="model1" name="Circadian Oscillations" language="urn:sedml:language:sbml" source="
11      urn:miriam:biomodels.db:BIOMD0000000021" />
12    <model id="model2" name="Circadian Chaos" language="urn:sedml:language:sbml" source="model1">
13      <listOfChanges>
14        <changeAttribute target="/sbml:sbml/sbml:model/sbml:listOfParameters/sbml:parameter[@id='&quot;
15          V_mT&quot;]/@value" newValue="0.28" />
16        <changeAttribute target="/sbml:sbml/sbml:model/sbml:listOfParameters/sbml:parameter[@id='&quot;
17          V_dT&quot;]/@value" newValue="4.8" />
18      </listOfChanges>
19    </model>
20  </listOfModels>
21  <listOfTasks>
22    <task id="task1" modelReference="model1" simulationReference="simulation1" />
23    <task id="task2" modelReference="model2" simulationReference="simulation1" />
24  </listOfTasks>
25  <listOfDataGenerators>
26    <dataGenerator id="time" name="time">
27      <listOfVariables>
28        <variable id="t" taskReference="task1" symbol="urn:sedml:symbol:time" />
29      </listOfVariables>
30      <math xmlns="http://www.w3.org/1998/Math/MathML">
31        <ci> t </ci>
32      </math>
33    </dataGenerator>
34    <dataGenerator id="tim1" name="tim mRNA">
35      <listOfVariables>
36        <variable id="v1" taskReference="task1" target="/sbml:sbml/sbml:model/sbml:listOfSpecies/
37          sbml:species[@id='Mt']" />
38      </listOfVariables>
39      <math xmlns="http://www.w3.org/1998/Math/MathML">
40        <ci> v1 </ci>
41      </math>
42    </dataGenerator>
43    <dataGenerator id="per_tim1" name="nuclear PER-TIM complex">
44      <listOfVariables>
45        <variable id="v1a" taskReference="task1" target="/sbml:sbml/sbml:model/sbml:listOfSpecies/
46          sbml:species[@id='Cn']" />
47      </listOfVariables>
48      <math xmlns="http://www.w3.org/1998/Math/MathML">
```

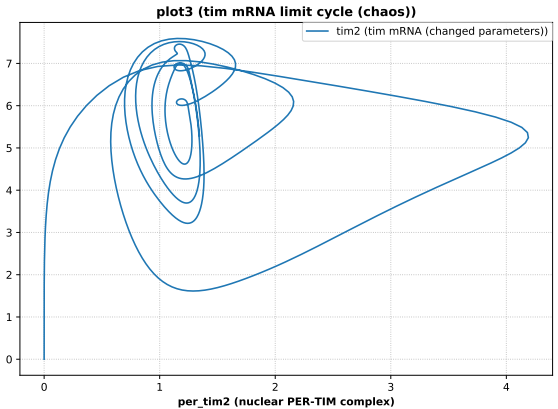
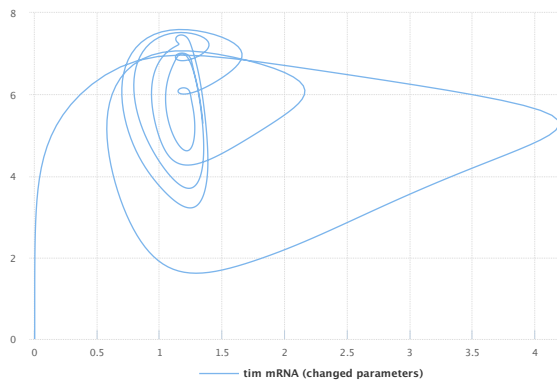
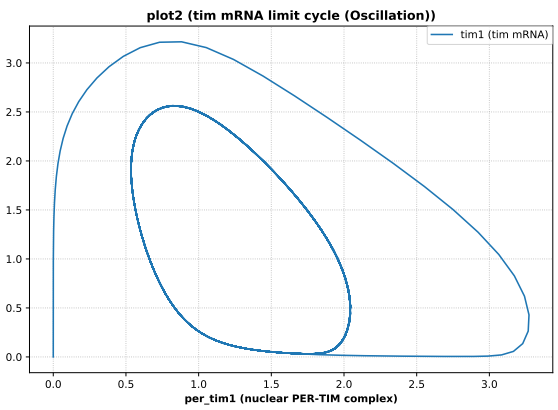
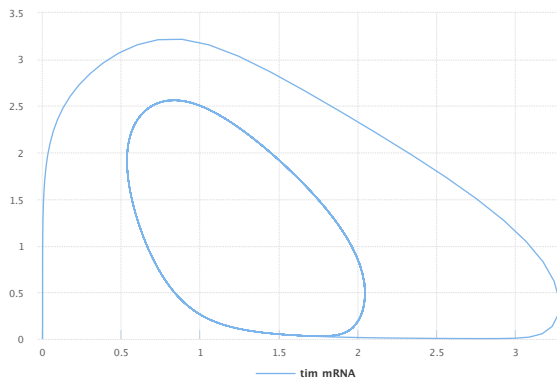
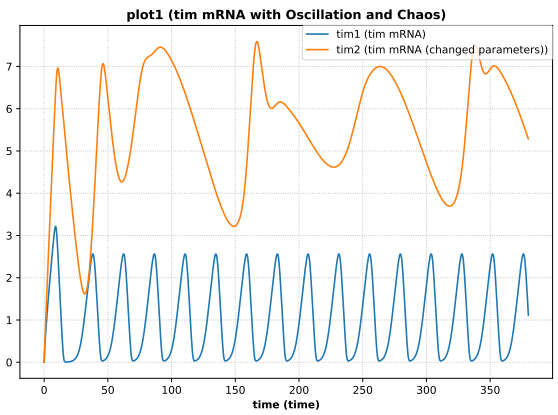
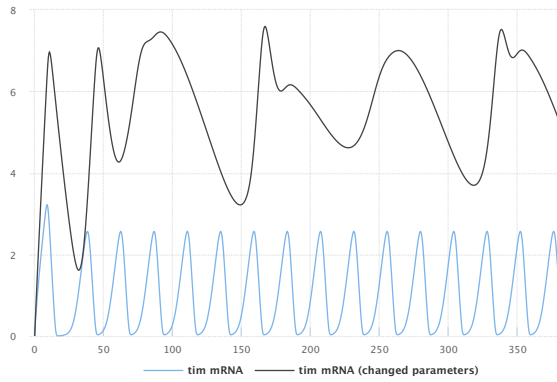

Figure A.17: The simulation result gained from the simulation description given in Listing A.10. Simulation with SED-ML web tools [2].

Figure A.18: Simulation with tellurium [5].

```

43     <ci> v1a </ci>
44   </math>
45 </dataGenerator>
46 <dataGenerator id="tim2" name="tim mRNA (changed parameters)">
47   <listOfVariables>
48     <variable id="v2" taskReference="task2" target="/sbml:sbml/sbml:model/sbml:listOfSpecies/
49       sbml:species[@id='Mt']" />
50   </listOfVariables>
51   <math xmlns="http://www.w3.org/1998/Math/MathML">
52     <ci> v2 </ci>
53   </math>
54 </dataGenerator>
55 <dataGenerator id="per_tim2" name="nuclear PER-TIM complex">
56   <listOfVariables>
57     <variable id="v2a" taskReference="task2" target="/sbml:sbml/sbml:model/sbml:listOfSpecies/
58       sbml:species[@id='Cn']" />
59   </listOfVariables>
60   <math xmlns="http://www.w3.org/1998/Math/MathML">

```

```

59     <ci> v2a </ci>
60   </math>
61 </dataGenerator>
62 </listOfDataGenerators>
63 <listOfOutputs>
64   <plot2D id="plot1" name="tim mRNA with Oscillation and Chaos">
65     <listOfCurves>
66       <curve id="c1" logX="false" logY="false" xDataReference="time" yDataReference="tim1" />
67       <curve id="c2" logX="false" logY="false" xDataReference="time" yDataReference="tim2" />
68     </listOfCurves>
69   </plot2D>
70   <plot2D id="plot2" name="tim mRNA limit cycle (Oscillation)">
71     <listOfCurves>
72       <curve id="c3" logX="false" logY="false" xDataReference="per_tim1" yDataReference="tim1" />
73     </listOfCurves>
74   </plot2D>
75   <plot2D id="plot3" name="tim mRNA limit cycle (chaos)">
76     <listOfCurves>
77       <curve id="c4" logX="false" logY="false" xDataReference="per_tim2" yDataReference="tim2" />
78     </listOfCurves>
79   </plot2D>
80 </listOfOutputs>
81 </sedML>

```

Listing A.10: *LeLoup Model Simulation Description in SED-ML*

A.5.2 IkappaB signaling (L1V3_ikkapab.omex)

The following example provides a SED-ML description for the simulation of the IkappaB-NF-kappaB signaling module described in [12].

This model is referenced by its SED-ML ID `model1` and refers to the model with the MIRIAM URN `urn:miriam:biomodels.db:BIOMD0000000140`. Software applications interpreting this example know how to dereference this URN and access the model in BioModels Database [15].

The simulation description specifies one simulation `simulation1`, which is a uniform timecourse simulation that simulates the model for 41 hours. `task1` then applies this simulation to the model.

As output this simulation description collects four parameters: `Total_NFkBn`, `Total_IkBbeta`, `Total_IkBeps` and `Total_IkBalpha`. These variables are plotted against the simulation time as shown in Figure A.19 and A.20.

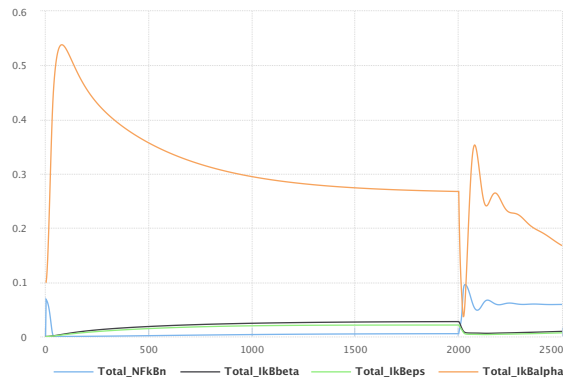

Figure A.19: *The simulation result gained from the simulation description given in Listing A.11. Simulation with SED-ML web tools [2].*

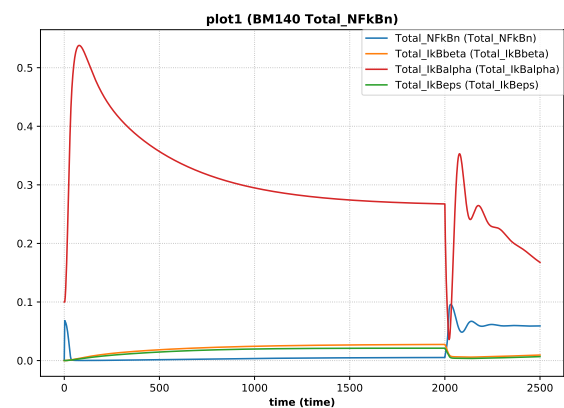

Figure A.20: *Simulation with tellurium [5].*

```

1 <?xml version="1.0" encoding="utf-8"?>
2 <sedML xmlns="http://sed-ml.org/sed-ml/level1/version3" level="1" version="3">
3   <listOfSimulations>
4     <uniformTimeCourse id="simulation1"
5       initialTime="0" outputStartTime="0" outputEndTime="2500"
6       numberOfPoints="1000" >
7       <algorithm kisaoID="KISA0:0000019"/>
8     </uniformTimeCourse>
9   </listOfSimulations>
10  </listOfModels>

```

```

11     <model id="model1" language="urn:sedml:language:sbml" source="urn:miriam:biomodels.db:BIOMD0000000140
12     "/>
13 </listOfModels>
14 <listOfTasks>
15   <task id="task1" modelReference="model1"
16     simulationReference="simulation1"/>
17 </listOfTasks>
18 <listOfDataGenerators>
19   <dataGenerator id="time" name="time">
20     <listOfVariables>
21       <variable id="time1" taskReference="task1" symbol="urn:sedml:symbol:time"/>
22     </listOfVariables>
23     <math xmlns="http://www.w3.org/1998/Math/MathML">
24       <ci>time1</ci>
25     </math>
26   </dataGenerator>
27   <dataGenerator id="Total_NFkBn" name="Total_NFkBn">
28     <listOfVariables>
29       <variable id="Total_NFkBn1" taskReference="task1"
30         target="/sbml:sbml/sbml:model/sbml:listOfParameters/sbml:parameter[@id='Total_NFkBn']"/>
31     </listOfVariables>
32     <math xmlns="http://www.w3.org/1998/Math/MathML">
33       <ci>Total_NFkBn1</ci>
34     </math>
35   </dataGenerator>
36   <dataGenerator id="Total_IkBbeta" name="Total_IkBbeta">
37     <listOfVariables>
38       <variable id="Total_IkBbeta1" taskReference="task1"
39         target="/sbml:sbml/sbml:model/sbml:listOfParameters/sbml:parameter[@id='Total_IkBbeta']" />
40     </listOfVariables>
41     <math xmlns="http://www.w3.org/1998/Math/MathML">
42       <ci>Total_IkBbeta1</ci>
43     </math>
44   </dataGenerator>
45   <dataGenerator id="Total_IkBeps" name="Total_IkBeps">
46     <listOfVariables>
47       <variable id="Total_IkBeps1" taskReference="task1"
48         target="/sbml:sbml/sbml:model/sbml:listOfParameters/sbml:parameter[@id='Total_IkBeps']" />
49     </listOfVariables>
50     <math xmlns="http://www.w3.org/1998/Math/MathML">
51       <ci>Total_IkBeps1</ci>
52     </math>
53   </dataGenerator>
54   <dataGenerator id="Total_IkBalpha" name="Total_IkBalpha">
55     <listOfVariables>
56       <variable id="Total_IkBalpha1" taskReference="task1"
57         target="/sbml:sbml/sbml:model/sbml:listOfParameters/sbml:parameter[@id='Total_IkBalpha']" />
58     </listOfVariables>
59     <math xmlns="http://www.w3.org/1998/Math/MathML">
60       <ci>Total_IkBalpha1</ci>
61     </math>
62   </dataGenerator>
63 </listOfDataGenerators>
64 <listOfOutputs>
65   <plot2D id="plot1" name="BM140 Total_NFkBn">
66     <listOfCurves>
67       <curve id="c1" logX="false" logY="false" xDataReference="time"
68         yDataReference="Total_NFkBn" />
69       <curve id="c2" logX="false" logY="false" xDataReference="time"
70         yDataReference="Total_IkBbeta" />
71       <curve id="c3" logX="false" logY="false" xDataReference="time"
72         yDataReference="Total_IkBeps" />
73       <curve id="c4" logX="false" logY="false" xDataReference="time"
74         yDataReference="Total_IkBalpha" />
75     </listOfCurves>
76   </plot2D>
77 </listOfOutputs>
78 </sedML>

```

Listing A.11: *IkappaB-NF-kappaB signaling Model Simulation Description in SED-ML*

B. XML Schema

Listing B.1 shows the full SED-ML XML Schema.

```
1 <xs:schema targetNamespace="http://sed-ml.org/sed-ml/level1/version3" xmlns="http://sed-ml.org/sed-ml/
  level1/version3"
2   xmlns:xs="http://www.w3.org/2001/XMLSchema" xmlns:math="http://www.w3.org/1998/Math/MathML"
3   elementFormDefault="qualified">
4   <xs:import namespace="http://www.w3.org/1998/Math/MathML" schemaLocation="sedml-mathml.xsd" />
5
6
7   <xs:simpleType name="SID">
8     <xs:annotation>
9       <xs:documentation>
10        The type SID is used throughout SED-ML as the
11        type of the 'id' attributes on SED-ML elements.
12      </xs:documentation>
13    </xs:annotation>
14    <xs:restriction base="xs:string">
15      <xs:pattern value="(_|[a-z]|[A-Z])(_|[a-z]|[A-Z]|[0-9])*" />
16    </xs:restriction>
17  </xs:simpleType>
18
19  <!-- Attribute group for elements with ID & name attributes -->
20  <xs:attributeGroup name="idGroup">
21    <xs:attribute name="id" use="required" type="SID"></xs:attribute>
22    <xs:attribute name="name" use="optional" type="xs:string"></xs:attribute>
23  </xs:attributeGroup>
24
25  <!-- SED Base class -->
26  <xs:complexType name="SEDBase">
27    <xs:annotation>
28      <xs:documentation xml:lang="en">
29        The SEDBase type is the
30        base type of all main types in SED-ML. It
31        serves as a container for
32        the annotation of any part of the
33        experiment description.
34      </xs:documentation>
35    </xs:annotation>
36    <xs:sequence>
37      <xs:element ref="notes" minOccurs="0" />
38      <xs:element ref="annotation" minOccurs="0" />
39    </xs:sequence>
40    <!--
41      This must be a variable-type identifier, i.e., (Letter | '_'
42      (NCNameChar)* that is unique in the document.
43    -->
44    <xs:attribute name="metaid" type="xs:ID" use="optional"></xs:attribute>
45  </xs:complexType>
46
47  <!-- SED ML Top level element -->
48  <xs:element name="sedML">
49    <xs:complexType>
50      <xs:complexContent>
51        <xs:extension base="SEDBase">
52          <xs:sequence>
53            <xs:element ref="listOfDataDescriptions" minOccurs="0" />
54            <xs:element ref="listOfSimulations" minOccurs="0" />
55            <xs:element ref="listOfModels" minOccurs="0" />
56            <xs:element ref="listOfTasks" minOccurs="0" />
57            <xs:element ref="listOfDataGenerators" minOccurs="0" />
58            <xs:element ref="listOfOutputs" minOccurs="0" />
59          </xs:sequence>
60          <xs:attribute name="level" type="xs:decimal" use="required" fixed="1" />
61          <xs:attribute name="version" type="xs:decimal" use="required" fixed="3" />
62        </xs:extension>
63      </xs:complexContent>
64    </xs:complexType>
65  </xs:element>
66
67  <!-- notes and annotations -->
68  <xs:element name="notes">
```



```

69     <xs:complexType>
70     <xs:sequence>
71         <xs:any namespace="http://www.w3.org/1999/xhtml"
72             processContents="skip" minOccurs="0" maxOccurs="unbounded" />
73     </xs:sequence>
74 </xs:complexType>
75 </xs:element>
76 <xs:element name="annotation">
77     <xs:complexType>
78         <xs:sequence>
79             <xs:any processContents="skip" minOccurs="0" maxOccurs="unbounded" />
80         </xs:sequence>
81     </xs:complexType>
82 </xs:element>
83
84 <!-- KiSAO ID type -->
85 <xs:simpleType name="KisaoType">
86     <xs:restriction base="xs:string">
87         <xs:pattern value="KISA0:[0-9]{7}" />
88     </xs:restriction>
89 </xs:simpleType>
90
91 <!-- global element declarations -->
92 <xs:element name="variable">
93     <xs:complexType>
94         <xs:complexContent>
95             <xs:extension base="SEDBase">
96                 <!-- at least one of taskReference or modelReference must be set -->
97                 <xs:attribute name="taskReference" type="SID" use="optional" />
98                 <xs:attribute name="modelReference" type="SID" use="optional" />
99
100                 <!-- either target or symbol have to be used in the variable definition -->
101                 <xs:attribute name="target" type="xs:token" use="optional" />
102                 <xs:attribute name="symbol" type="xs:string" use="optional" />
103                 <xs:attributeGroup ref="idGroup" />
104             </xs:extension>
105         </xs:complexContent>
106     </xs:complexType>
107 </xs:element>
108
109 <xs:element name="parameter">
110     <xs:complexType>
111         <xs:complexContent>
112             <xs:extension base="SEDBase">
113                 <xs:attributeGroup ref="idGroup" />
114                 <xs:attribute name="value" type="xs:double" use="required" />
115             </xs:extension>
116         </xs:complexContent>
117     </xs:complexType>
118 </xs:element>
119
120 <!-- The model(s) to simulate/analyse -->
121 <xs:element name="model">
122     <xs:complexType>
123         <xs:complexContent>
124             <xs:extension base="SEDBase">
125                 <xs:sequence>
126                     <xs:element ref="listOfChanges" minOccurs="0" />
127                 </xs:sequence>
128                 <xs:attribute name="language" type="xs:anyURI" use="optional"
129                     default="urn:sedml:language:xml" />
130                 <xs:attribute name="source" type="xs:anyURI" use="required" />
131                 <xs:attributeGroup ref="idGroup" />
132             </xs:extension>
133         </xs:complexContent>
134     </xs:complexType>
135 </xs:element>
136
137 <!-- Model pre-processing changes -->
138 <xs:element name="newXML">
139     <xs:complexType>
140         <xs:sequence>
141             <xs:any processContents="skip" minOccurs="1" maxOccurs="unbounded" />
142         </xs:sequence>
143     </xs:complexType>
144 </xs:element>
145
146 <xs:element name="changeAttribute">
147     <xs:complexType>
148         <xs:complexContent>
149             <xs:extension base="SEDBase">
150                 <xs:attribute name="target" use="required" type="xs:token" />
151                 <xs:attribute name="newValue" type="xs:string" use="required" />
152             </xs:extension>
153         </xs:complexContent>
154     </xs:complexType>
155 </xs:element>
156
157 <xs:element name="changeXML">

```

```

158     <xs:complexType>
159       <xs:complexContent>
160         <xs:extension base="SEDBase">
161           <xs:sequence>
162             <xs:element ref="newXML" />
163           </xs:sequence>
164           <xs:attribute name="target" use="required" type="xs:token" />
165         </xs:extension>
166       </xs:complexContent>
167     </xs:complexType>
168 </xs:element>
169
170 <xs:element name="addXML">
171   <xs:complexType>
172     <xs:complexContent>
173       <xs:extension base="SEDBase">
174         <xs:sequence>
175           <xs:element ref="newXML" />
176         </xs:sequence>
177         <xs:attribute name="target" use="required" type="xs:token" />
178       </xs:extension>
179     </xs:complexContent>
180   </xs:complexType>
181 </xs:element>
182
183 <xs:element name="removeXML">
184   <xs:complexType>
185     <xs:complexContent>
186       <xs:extension base="SEDBase">
187         <xs:attribute name="target" use="required" type="xs:token" />
188       </xs:extension>
189     </xs:complexContent>
190   </xs:complexType>
191 </xs:element>
192
193 <xs:complexType name="ComputeChange">
194   <xs:complexContent>
195     <xs:extension base="SEDBase">
196       <xs:sequence>
197         <xs:element ref="listOfVariables" minOccurs="0" />
198         <xs:element ref="listOfParameters" minOccurs="0" />
199         <xs:element ref="math:math" />
200       </xs:sequence>
201       <xs:attribute name="target" use="required" type="xs:token" />
202     </xs:extension>
203   </xs:complexContent>
204 </xs:complexType>
205
206 <xs:element name="computeChange" type="ComputeChange"/>
207
208
209 <!-- The simulation/analysis algorithms to use -->
210 <xs:element name="algorithm">
211   <xs:complexType>
212     <xs:complexContent>
213       <xs:extension base="SEDBase">
214         <xs:sequence>
215           <xs:element ref="listOfAlgorithmParameters" minOccurs="0"/>
216         </xs:sequence>
217         <xs:attribute name="kisaoID" type="KisaoType" use="required" />
218       </xs:extension>
219     </xs:complexContent>
220   </xs:complexType>
221 </xs:element>
222
223 <xs:element name="algorithmParameter">
224   <xs:complexType>
225     <xs:complexContent>
226       <xs:extension base="SEDBase">
227         <xs:attribute name="kisaoID" type="KisaoType" use="required"/>
228         <xs:attribute name="value" type="xs:string" use="required"/>
229       </xs:extension>
230     </xs:complexContent>
231   </xs:complexType>
232 </xs:element>
233
234 <xs:complexType name="Simulation">
235   <xs:complexContent>
236     <xs:extension base="SEDBase">
237       <xs:sequence>
238         <xs:element ref="algorithm" />
239       </xs:sequence>
240       <xs:attributeGroup ref="idGroup" />
241     </xs:extension>
242   </xs:complexContent>
243 </xs:complexType>
244
245 <xs:element name="uniformTimeCourse">
246   <xs:complexType>

```

```

247         <xs:complexContent>
248           <xs:extension base="Simulation">
249             <xs:attribute name="outputStartTime" type="xs:double" use="required" />
250             <xs:attribute name="outputEndTime" type="xs:double" use="required" />
251             <xs:attribute name="numberOfPoints" type="xs:integer" use="required" />
252             <xs:attribute name="initialTime" type="xs:double" use="required" />
253           </xs:extension>
254         </xs:complexContent>
255       </xs:complexType>
256     </xs:element>
257
258     <xs:element name="oneStep">
259       <xs:complexType>
260         <xs:complexContent>
261           <xs:extension base="Simulation">
262             <xs:attribute name="step" type="xs:double" use="required"/>
263           </xs:extension>
264         </xs:complexContent>
265       </xs:complexType>
266     </xs:element>
267
268     <xs:element name="steadyState">
269       <xs:complexType>
270         <xs:complexContent>
271           <xs:extension base="Simulation">
272             <!-- There is actually no difference from the base type here -->
273           </xs:extension>
274         </xs:complexContent>
275       </xs:complexType>
276     </xs:element>
277
278     <!-- The various task elements inherit from AbstractTask -->
279     <xs:complexType name="AbstractTask">
280       <xs:complexContent>
281         <xs:extension base="SEDBase">
282           <xs:attributeGroup ref="idGroup" />
283         </xs:extension>
284       </xs:complexContent>
285     </xs:complexType>
286
287     <xs:element name="task">
288       <xs:complexType>
289         <xs:complexContent>
290           <xs:extension base="AbstractTask">
291             <xs:attribute name="simulationReference" type="Sid" use="required" />
292             <xs:attribute name="modelReference" type="Sid" use="required" />
293           </xs:extension>
294         </xs:complexContent>
295       </xs:complexType>
296     </xs:element>
297
298     <xs:element name="repeatedTask">
299       <xs:complexType>
300         <xs:complexContent>
301           <xs:extension base="AbstractTask">
302             <xs:sequence>
303               <xs:element ref="listOfRanges"/>
304               <xs:element name="listOfChanges" type="repeatedTaskListOfChanges"
305                 minOccurs="0"/>
306               <xs:element ref="listOfSubTasks"/>
307             </xs:sequence>
308             <xs:attribute name="range" type="Sid" use="required"/>
309             <xs:attribute name="resetModel" type="Sid" use="required"/>
310           </xs:extension>
311         </xs:complexContent>
312       </xs:complexType>
313     </xs:element>
314
315     <!-- Child elements of repeatedTask -->
316     <xs:complexType name="Range">
317       <xs:complexContent>
318         <xs:extension base="SEDBase">
319           <xs:attributeGroup ref="idGroup"/>
320         </xs:extension>
321       </xs:complexContent>
322     </xs:complexType>
323
324     <xs:simpleType name="LogOrLinear">
325       <xs:restriction base="xs:string">
326         <xs:enumeration value="log"/>
327         <xs:enumeration value="linear"/>
328       </xs:restriction>
329     </xs:simpleType>
330
331     <xs:element name="uniformRange">
332       <xs:complexType>
333         <xs:complexContent>
334           <xs:extension base="Range">
335             <xs:attribute name="start" type="xs:double"/>

```

```

336         <xs:attribute name="end" type="xs:double"/>
337         <xs:attribute name="numberOfPoints" type="xs:integer"/>
338         <xs:attribute name="type" type="LogOrLinear"/>
339     </xs:extension>
340 </xs:complexType>
341 </xs:element>
342
343
344 <xs:element name="vectorRange">
345     <xs:complexType>
346         <xs:complexContent>
347             <xs:extension base="Range">
348                 <xs:sequence>
349                     <xs:element name="value" type="xs:double" maxOccurs="unbounded"/>
350                 </xs:sequence>
351             </xs:extension>
352         </xs:complexContent>
353     </xs:complexType>
354 </xs:element>
355
356 <xs:element name="functionalRange">
357     <xs:complexType>
358         <xs:complexContent>
359             <xs:extension base="Range">
360                 <xs:sequence>
361                     <xs:element ref="listOfVariables" minOccurs="0" />
362                     <xs:element ref="listOfParameters" minOccurs="0" />
363                     <xs:element ref="math:math" />
364                 </xs:sequence>
365                 <xs:attribute name="range" type="SID" use="optional"/>
366             </xs:extension>
367         </xs:complexContent>
368     </xs:complexType>
369 </xs:element>
370
371 <xs:element name="setValue">
372     <xs:complexType>
373         <xs:complexContent>
374             <xs:extension base="ComputeChange">
375                 <xs:attribute name="modelReference" type="SID" use="required"/>
376                 <xs:attribute name="range" type="SID" use="optional"/>
377                 <xs:attribute name="symbol" type="xs:string" use="optional"/>
378             </xs:extension>
379         </xs:complexContent>
380     </xs:complexType>
381 </xs:element>
382
383 <xs:element name="subTask">
384     <xs:complexType>
385         <xs:complexContent>
386             <xs:extension base="SEDBase">
387                 <xs:attribute name="task" type="SID" use="required"/>
388                 <xs:attribute name="order" type="xs:integer" use="optional"/>
389             </xs:extension>
390         </xs:complexContent>
391     </xs:complexType>
392 </xs:element>
393
394 <!-- Post-processing using a data generator -->
395 <xs:element name="dataGenerator">
396     <xs:complexType>
397         <xs:complexContent>
398             <xs:extension base="SEDBase">
399                 <xs:sequence>
400                     <xs:element ref="listOfVariables" minOccurs="0" />
401                     <xs:element ref="listOfParameters" minOccurs="0" />
402                     <xs:element ref="math:math" />
403                 </xs:sequence>
404                 <xs:attributeGroup ref="idGroup" />
405             </xs:extension>
406         </xs:complexContent>
407     </xs:complexType>
408 </xs:element>
409
410 <!-- Simulation experiment outputs -->
411 <xs:element name="plot2D">
412     <xs:complexType>
413         <xs:complexContent>
414             <xs:extension base="SEDBase">
415                 <xs:sequence>
416                     <xs:element ref="listOfCurves" minOccurs="0" />
417                 </xs:sequence>
418                 <xs:attributeGroup ref="idGroup" />
419             </xs:extension>
420         </xs:complexContent>
421     </xs:complexType>
422 </xs:element>
423
424 <xs:element name="plot3D">

```

```

425     <xs:complexType>
426     <xs:complexContent>
427     <xs:extension base="SEDBase">
428     <xs:sequence>
429     <xs:element ref="listOfSurfaces" minOccurs="0" />
430     </xs:sequence>
431     <xs:attributeGroup ref="idGroup" />
432     </xs:extension>
433     </xs:complexContent>
434 </xs:complexType>
435 </xs:element>
436
437 <xs:element name="report">
438 <xs:complexType>
439 <xs:complexContent>
440 <xs:extension base="SEDBase">
441 <xs:sequence>
442 <xs:element ref="listOfDataSets" minOccurs="0" />
443 </xs:sequence>
444 <xs:attributeGroup ref="idGroup" />
445 </xs:extension>
446 </xs:complexContent>
447 </xs:complexType>
448 </xs:element>
449
450 <xs:element name="curve">
451 <xs:complexType>
452 <xs:complexContent>
453 <xs:extension base="SEDBase">
454 <xs:attributeGroup ref="idGroup" />
455 <xs:attribute name="yDataReference" type="SId" use="required" />
456 <xs:attribute name="xDataReference" type="SId" use="required" />
457
458 <xs:attribute name="logY" use="required" type="xs:boolean" />
459 <xs:attribute name="logX" use="required" type="xs:boolean" />
460 </xs:extension>
461 </xs:complexContent>
462 </xs:complexType>
463 </xs:element>
464
465 <xs:element name="surface">
466 <xs:complexType>
467 <xs:complexContent>
468 <xs:extension base="SEDBase">
469 <xs:attributeGroup ref="idGroup" />
470 <xs:attribute name="yDataReference" type="SId" use="required" />
471 <xs:attribute name="xDataReference" type="SId" use="required" />
472 <xs:attribute name="zDataReference" type="SId" use="required" />
473 <xs:attribute name="logY" use="required" type="xs:boolean" />
474 <xs:attribute name="logX" use="required" type="xs:boolean" />
475 <xs:attribute name="logZ" use="required" type="xs:boolean" />
476 </xs:extension>
477 </xs:complexContent>
478 </xs:complexType>
479 </xs:element>
480
481 <xs:element name="dataSet">
482 <xs:complexType>
483 <xs:complexContent>
484 <xs:extension base="SEDBase">
485 <xs:attribute name="dataReference" type="SId" use="required" />
486 <xs:attribute name="label" use="required" type="xs:string" />
487 <xs:attributeGroup ref="idGroup" />
488 </xs:extension>
489 </xs:complexContent>
490 </xs:complexType>
491 </xs:element>
492
493 <!-- listOf elements -->
494 <xs:element name="listOfVariables">
495 <xs:complexType>
496 <xs:complexContent>
497 <xs:extension base="SEDBase">
498 <xs:sequence>
499 <xs:element ref="variable" minOccurs="0" maxOccurs="unbounded" />
500 </xs:sequence>
501 </xs:extension>
502 </xs:complexContent>
503 </xs:complexType>
504 </xs:element>
505
506 <xs:element name="listOfParameters">
507 <xs:complexType>
508 <xs:complexContent>
509 <xs:extension base="SEDBase">
510 <xs:sequence>
511 <xs:element ref="parameter" minOccurs="0" maxOccurs="unbounded" />
512 </xs:sequence>
513 </xs:extension>

```

```

514     </xs:complexContent>
515   </xs:complexType>
516 </xs:element>
517
518 <xs:element name="listOfAlgorithmParameters">
519   <xs:complexType>
520     <xs:complexContent>
521       <xs:extension base="SEDBase">
522         <xs:sequence>
523           <xs:element ref="algorithmParameter" minOccurs="0" maxOccurs="unbounded" />
524         </xs:sequence>
525       </xs:extension>
526     </xs:complexContent>
527   </xs:complexType>
528 </xs:element>
529
530 <xs:element name="listOfTasks">
531   <xs:complexType>
532     <xs:complexContent>
533       <xs:extension base="SEDBase">
534         <xs:choice minOccurs="0" maxOccurs="unbounded">
535           <xs:element ref="task" />
536           <xs:element ref="repeatedTask" />
537         </xs:choice>
538       </xs:extension>
539     </xs:complexContent>
540   </xs:complexType>
541 </xs:element>
542
543 <xs:element name="listOfDataDescriptions">
544   <xs:complexType>
545     <xs:complexContent>
546       <xs:extension base="SEDBase">
547         <xs:choice minOccurs="0" maxOccurs="unbounded">
548           <xs:element ref="dataDescription"/>
549         </xs:choice>
550       </xs:extension>
551     </xs:complexContent>
552   </xs:complexType>
553 </xs:element>
554
555 <xs:element name="dataDescription">
556   <xs:complexType>
557     <xs:complexContent>
558       <xs:extension base="SEDBase">
559         <xs:sequence>
560           <xs:element ref="dimensionDescription"/>
561           <xs:element ref="listOfDataSources"/>
562         </xs:sequence>
563         <xs:attribute name="source" type="xs:anyURI" use="required" />
564         <xs:attribute name="format" type="xs:anyURI" use="optional" />
565         <xs:attributeGroup ref="idGroup" />
566       </xs:extension>
567     </xs:complexContent>
568   </xs:complexType>
569 </xs:element>
570
571 <xs:element name="dimensionDescription">
572   <xs:complexType>
573     <xs:sequence>
574       <xs:any namespace="http://www.numl.org/numl/level1/version1"
575         processContents="skip" minOccurs="0" maxOccurs="unbounded" />
576     </xs:sequence>
577   </xs:complexType>
578 </xs:element>
579
580 <xs:element name="listOfDataSources">
581   <xs:complexType>
582     <xs:complexContent>
583       <xs:extension base="SEDBase">
584         <xs:choice minOccurs="0" maxOccurs="unbounded">
585           <xs:element ref="dataSource"/>
586         </xs:choice>
587       </xs:extension>
588     </xs:complexContent>
589   </xs:complexType>
590 </xs:element>
591
592 <xs:element name="dataSource">
593   <xs:complexType>
594     <xs:complexContent>
595       <xs:extension base="SEDBase">
596         <xs:sequence>
597           <xs:element ref="listOfSlices" minOccurs="0" maxOccurs="unbounded" />
598         </xs:sequence>
599         <xs:attribute name="indexSet" type="SID" use="optional" />
600         <xs:attributeGroup ref="idGroup" />
601       </xs:extension>
602     </xs:complexContent>

```

```

603     </xs:complexType>
604 </xs:element>
605
606 <xs:element name="listOfSlices">
607   <xs:complexType>
608     <xs:complexContent>
609       <xs:extension base="SEDBase">
610         <xs:choice minOccurs="0" maxOccurs="unbounded">
611           <xs:element ref="slice"/>
612         </xs:choice>
613       </xs:extension>
614     </xs:complexContent>
615   </xs:complexType>
616 </xs:element>
617
618 <xs:element name="slice">
619   <xs:complexType>
620     <xs:complexContent>
621       <xs:extension base="SEDBase">
622         <xs:attribute name="reference" type="SId" use="required" />
623         <xs:attribute name="value" type="xs:string" use="required" />
624       </xs:extension>
625     </xs:complexContent>
626   </xs:complexType>
627 </xs:element>
628
629 <xs:element name="listOfSimulations">
630   <xs:complexType>
631     <xs:complexContent>
632       <xs:extension base="SEDBase">
633         <xs:choice minOccurs="0" maxOccurs="unbounded">
634           <xs:element ref="uniformTimeCourse"/>
635           <xs:element ref="oneStep"/>
636           <xs:element ref="steadyState"/>
637         </xs:choice>
638       </xs:extension>
639     </xs:complexContent>
640   </xs:complexType>
641 </xs:element>
642
643 <xs:element name="listOfOutputs">
644   <xs:complexType>
645     <xs:complexContent>
646       <xs:extension base="SEDBase">
647         <xs:choice minOccurs="0" maxOccurs="unbounded">
648           <xs:element ref="plot2D" />
649           <xs:element ref="plot3D" />
650           <xs:element ref="report" />
651         </xs:choice>
652       </xs:extension>
653     </xs:complexContent>
654   </xs:complexType>
655 </xs:element>
656
657 <xs:element name="listOfModels">
658   <xs:complexType>
659     <xs:complexContent>
660       <xs:extension base="SEDBase">
661         <xs:sequence>
662           <xs:element ref="model" minOccurs="0" maxOccurs="unbounded" />
663         </xs:sequence>
664       </xs:extension>
665     </xs:complexContent>
666   </xs:complexType>
667 </xs:element>
668
669 <xs:element name="listOfDataGenerators">
670   <xs:complexType>
671     <xs:complexContent>
672       <xs:extension base="SEDBase">
673         <xs:sequence>
674           <xs:element ref="dataGenerator" minOccurs="0" maxOccurs="unbounded" />
675         </xs:sequence>
676       </xs:extension>
677     </xs:complexContent>
678   </xs:complexType>
679 </xs:element>
680
681 <xs:element name="listOfCurves">
682   <xs:complexType>
683     <xs:complexContent>
684       <xs:extension base="SEDBase">
685         <xs:sequence>
686           <xs:element ref="curve" maxOccurs="unbounded" />
687         </xs:sequence>
688       </xs:extension>
689     </xs:complexContent>
690   </xs:complexType>
691 </xs:element>

```

```

692
693 <xs:element name="listOfSurfaces">
694   <xs:complexType>
695     <xs:complexContent>
696       <xs:extension base="SEDBase">
697         <xs:sequence>
698           <xs:element ref="surface" maxOccurs="unbounded" />
699         </xs:sequence>
700       </xs:extension>
701     </xs:complexContent>
702   </xs:complexType>
703 </xs:element>
704
705 <xs:element name="listOfDataSets">
706   <xs:complexType>
707     <xs:complexContent>
708       <xs:extension base="SEDBase">
709         <xs:sequence>
710           <xs:element ref="dataSet" maxOccurs="unbounded" />
711         </xs:sequence>
712       </xs:extension>
713     </xs:complexContent>
714   </xs:complexType>
715 </xs:element>
716
717 <xs:element name="listOfChanges">
718   <xs:complexType>
719     <xs:complexContent>
720       <xs:extension base="SEDBase">
721         <xs:choice minOccurs="0" maxOccurs="unbounded">
722           <xs:element ref="changeAttribute" />
723           <xs:element ref="changeXML" />
724           <xs:element ref="addXML" />
725           <xs:element ref="removeXML" />
726           <xs:element ref="computeChange" />
727         </xs:choice>
728       </xs:extension>
729     </xs:complexContent>
730   </xs:complexType>
731 </xs:element>
732
733 <xs:element name="listOfRanges">
734   <xs:complexType>
735     <xs:complexContent>
736       <xs:extension base="SEDBase">
737         <xs:choice maxOccurs="unbounded">
738           <xs:element ref="uniformRange" />
739           <xs:element ref="vectorRange" />
740           <xs:element ref="functionalRange" />
741         </xs:choice>
742       </xs:extension>
743     </xs:complexContent>
744   </xs:complexType>
745 </xs:element>
746
747 <xs:complexType name="repeatedTaskListOfChanges">
748   <xs:complexContent>
749     <xs:extension base="SEDBase">
750       <xs:sequence>
751         <xs:element ref="setValue" minOccurs="0" maxOccurs="unbounded" />
752       </xs:sequence>
753     </xs:extension>
754   </xs:complexContent>
755 </xs:complexType>
756
757 <xs:element name="listOfSubTasks">
758   <xs:complexType>
759     <xs:complexContent>
760       <xs:extension base="SEDBase">
761         <xs:sequence>
762           <xs:element ref="subTask" maxOccurs="unbounded" />
763         </xs:sequence>
764       </xs:extension>
765     </xs:complexContent>
766   </xs:complexType>
767 </xs:element>
768 </xs:schema>

```

Listing B.1: *The SED-ML XML Schema definition*

Bibliography

- [1] F. T. Bergmann, R. Adams, S. Moodie, J. Cooper, M. Glont, M. Golebiewski, M. Hucka, C. Laibe, A. K. Miller, D. P. Nickerson, B. G. Olivier, N. Rodriguez, H. M. Sauro, M. Scharm, S. Soiland-Reyes, D. Waltemath, F. Yvon, and N. Le Novère. COMBINE archive and OMEX format: one file to share all information to reproduce a modeling project. *BMC bioinformatics*, 15:369, Dec. 2014.
- [2] F. T. Bergmann, D. Nickerson, D. Waltemath, and M. Scharm. SED-ML web tools: generate, modify and export standard-compliant simulation studies. *Bioinformatics*, 33(8):1253–1254, 2017.
- [3] T. Berners-Lee, R. Fielding, and L. Masinter. Uniform Resource Identifier (URI): Generic Syntax, 2005.
- [4] D. Carlisle, P. Ion, R. Miner, and N. Poppelier. Mathematical Markup Language (MathML) version 2.0. *W3C Recommendation*, 21, 2001.
- [5] K. Choi, J. K. Medley, C. Cannistra, M. König, L. Smith, K. Stocking, and H. M. Sauro. Tellurium: A python based modeling and reproducibility platform for systems biology. *bioRxiv*, 2016.
- [6] J. Clarke and S. DeRose. XML Path Language (XPath) version 1.0, 1999.
- [7] M. Courtot, N. Juty, C. Knüpfer, D. Waltemath, A. Dräger, A. andFinney, M. Golebiewski, S. Hoops, S. Keating, D. Kell, S. Kerrien, J. Lawson, A. Lister, J. Lu, R. Machne, P. Mendes, M. Pocock, N. Rodriguez, A. Villegier, S. Wimalaratne, C. Laibe, M. Hucka, and N. Le Novère. Controlled vocabularies and semantics in Systems Biology. *Mol Sys Biol*, 7, Oct. 2011.
- [8] A. A. Cuellar, C. M. Lloyd, P. F. Nielson, M. D. B. Halstead, D. P. Bullivant, D. P. Nickerson, and P. J. Hunter. An overview of CellML 1.1, a biological model description language. *Simulation*, 79(12):740–747, 2003.
- [9] M. Elowitz and S. Leibler. A synthetic oscillatory network of transcriptional regulators. *Nature*, 403(6767):335–338, Jan. 2000.
- [10] A. Garny and P. J. Hunter. OpenCOR: a modular and interoperable approach to computational biology. *Frontiers in physiology*, 6, 2015.
- [11] N. Goddard, M. Hucka, F. Howell, H. Cornelis, K. Skankar, and D. Beeman. Towards NeuroML: Model Description Methods for Collaborative Modeling in Neuroscience. *Phil. Trans. Royal Society series B*, 356:1209–1228, 2001.
- [12] A. Hoffmann, A. Levchenko, M. L. Scott, and D. Baltimore. The I κ B-NF- κ B signaling module: temporal control and selective gene activation. *Science*, 298(5596):1241–1245, 2002.
- [13] M. Hucka, F. Bergmann, S. Hoops, S. Keating, S. Sahle, and D. Wilkinson. The Systems Biology Markup Language (SBML): Language Specification for Level 3 Version 1 Core (Release 1 Candidate). *Nature Precedings*, January 2010.
- [14] M. Hucka, A. Finney, H. M. Sauro, H. Bolouri, J. C. Doyle, H. Kitano, A. P. Arkin, B. J. Bornstein, D. Bray, A. Cornish-Bowden, A. A. Cuellar, S. Dronov, E. D. Gilles, M. Ginkel, V. Gor, I. I. Goryanin, W. J. Hedley, T. C. Hodgman, J. H. Hofmeyr, P. J. Hunter, N. S. Juty, J. L. Kasberger, A. Kreamling, U. Kummer, N. Le Novere, L. M. Loew, D. Lucio, P. Mendes, E. Minch, E. D. Mjolsness, Y. Nakayama, M. R. Nelson, P. F. Nielsen, T. Sakurada, J. C. Schaff, B. E. Shapiro, T. S. Shimizu, H. D. Spence, J. Stelling, K. Takahashi, M. Tomita, J. Wagner, and J. Wang. The systems biology markup language (SBML): a medium for representation and exchange of biochemical network models. *Bioinformatics*, 19(4):524–531, March 2003.

- [15] N. Le Novère, B. Bornstein, A. Broicher, M. Courtot, M. Donizelli, H. Dharuri, L. Li, H. Sauro, M. Schilstra, B. Shapiro, J. L. Snoep, and M. Hucka. BioModels Database: a free, centralized database of curated, published, quantitative kinetic models of biochemical and cellular systems. *Nucleic Acids Res*, 34(Database issue), January 2006.
- [16] J.-C. Leloup, D. Gonze, and A. Goldbeter. Limit cycle models for circadian rhythms based on transcriptional regulation in drosophila and neurospora. *Journal of Biological Rhythms*, 14(6):433–448, 1999.
- [17] C. Li, M. Donizelli, N. Rodriguez, H. Dharuri, L. Endler, V. Chelliah, L. Li, E. He, A. Henry, M. Stefan, J. Snoep, M. Hucka, N. Le Novère, and C. Laibe. BioModels Database: An enhanced, curated and annotated resource for published quantitative kinetic models. *BMC Systems Biology*, 4(1):92+, June 2010.
- [18] S. Pemberton et al. XHTML 1.0: The Extensible HyperText Markup Language—W3C Recommendation 26 January 2000. *World Wide Web Consortium (W3C)(August 2002)*, 2002.
- [19] D. Waltemath, R. Adams, D. Beard, F. Bergmann, U. Bhalla, R. Britten, V. Chelliah, M. Cooling, J. Cooper, E. Crampin, A. Garny, S. Hoops, M. Hucka, P. Hunter, E. Klipp, C. Laibe, A. Miller, I. Moraru, D. Nickerson, P. Nielsen, M. Nikolski, S. Sahle, H. Sauro, H. Schmidt, J. Snoep, D. Tolle, O. Wolkenhauer, and N. Le Novère. Minimum Information About a Simulation Experiment (MIASE). *PLoS Comput Biol*, 7:e1001122, 2011.
- [20] D. Waltemath, R. Adams, F. T. Bergmann, M. Hucka, F. Kolpakov, A. K. Miller, I. I. Moraru, D. Nickerson, S. Sahle, J. L. Snoep, and N. Le Novère. Reproducible computational biology experiments with SED-ML: the simulation experiment description markup language. *BMC systems biology*, 5(1):198, 2011.