

Article

The Use of Lignin as a Microbial Carrier in the Co-Digestion of Cheese and Wafer Waste

Agnieszka A. Pilarska ^{1,*} , Agnieszka Wolna-Maruwka ², Krzysztof Pilarski ³, Damian Janczak ³, Krzysztof Przybył ¹ and Marzena Gawrysiak-Witulska ¹

¹ Institute of Food Technology of Plant Origin, Poznań University of Life Sciences, Wojska Polskiego 31, 60-637 Poznań, Poland; kprzybyl@up.poznan.pl (K.P.); marzena.gawrysiak-witulska@up.poznan.pl (M.G.-W.)

² Department of General and Environmental Microbiology, Poznań University of Life Sciences, Wojska Polskiego 31, 60-637 Poznań, Poland; amaruwka@up.poznan.pl

³ Institute of Biosystems Engineering, Poznań University of Life Sciences, Wojska Polskiego 50, 60-637 Poznań, Poland; pilarski@up.poznan.pl (K.P.); djanczak@up.poznan.pl (D.J.)

* Correspondence: pilarska@up.poznan.pl; Tel.: +48-61-848-73-08

Received: 7 November 2019; Accepted: 7 December 2019; Published: 12 December 2019



Abstract: The aim of the article was to present the effects of lignin grafted with polyvinylpyrrolidone (PVP) as a microbial carrier in anaerobic co-digestion (AcoD) of cheese (CE) and wafer waste (WF). Individual samples of waste cheese and wafers were also tested. The PVP modifier was used to improve the adhesive properties of the carrier surface. Lignin is a natural biopolymer which exhibits all the properties of a good carrier, including nontoxicity, biocompatibility, porosity, and thermal stability. Moreover, the analysis of the zeta potential of lignin and lignin combined with PVP showed their high electrokinetic stability within a wide pH range, that is, 4–11. The AcoD process was conducted under mesophilic conditions in a laboratory by means of anaerobic batch reactors. Monitoring with two standard parameters: pH and the VFA/TA ratio (volatile fatty acids-to-total alkalinity ratio) proved that the process was stable in all the samples tested. The high share of $N-NH_4^+$ in TKN (total Kjeldahl nitrogen), which exceeded 90% for WF+CE and CE at the last phases of the process, proved the effective conversion of nitrogen forms. The microbiological analyses showed that eubacteria proliferated intensively and the dehydrogenase activity increased in the samples containing the carrier, especially in the system with two co-substrates (WF+CE/lignin) and in the waste cheese sample (CE/lignin). The biogas production increased from 1102.00 $m^3 Mg^{-1} VS$ (volatile solids) to 1257.38 $m^3 Mg^{-1} VS$ in the WF+CE/lignin sample, and from 881.26 $m^3 Mg^{-1} VS$ to 989.65 $m^3 Mg^{-1} VS$ in the CE/lignin sample. The research results showed that the cell immobilization on lignin had very positive effect on the anaerobic digestion process.

Keywords: lignin; microbial carrier; cheese waste; wafer waste; biogas production

1. Introduction

The dairy industry generates significant amounts of waste at various stages of the production chain, especially in cheese production processes [1]. In spite of the specific possibilities to use selected types of waste, including permeate, whey protein concentrate, and isolate products [2], other liquid and solid wastes produced in large amounts require effective disposal methods.

At present, anaerobic digestion (AD) is thought to be the most sustainable solution in waste management and energy recovery, also in the dairy sector [3]. Although this is an environment-friendly and promising method, its implementation may cause problems, mostly due to the chemical composition of dairy waste (i.e., acidic pH, high concentration of mineral salts) [4]. The breakdown of typical protein waste containing casein involves the release of ammonia and hydrogen sulphide, which inhibit the

anaerobic digestion [3]. In this case, the accumulation of volatile fatty acids (VFA) originating from the coexistent fat may occur equally frequently. In order to solve technical problems, various configurations of reactors, operating under mesophilic or thermophilic conditions, were tested [5–7]. There have also been attempts to stabilize the system by supplementation with alkalizing compounds [8]. However, for economic reasons it is more common to combine dairy waste with other co-substrates, buffering the system and improving the balance of carbon and nutrients [9–11]. The composition of an effective co-substrate should complement the basic substrate and cause synergistic effects [12]. Confectionery waste is the material that potentially meets the abovementioned conditions regarding cheese waste. The confectionery industry continuously generates large amounts of waste. Apart from being recycled, it should be disposed of or used in accordance with the principles of sustainable development [13]. As stated in previous studies, confectionery waste undoubtedly has high biochemical methane potential (BMP) due to its composition and physicochemical properties [14,15].

Researchers try to modify the AD process conditions to ensure better distribution of microbial species in a suitable habitat, provide them with constant access to valuable nutrients and appropriate pH in their environment so as to improve their metabolic activity [16]. One of the methods improving the condition of methanogens and other mixed cultures is their immobilization with an appropriate carrier [17]. Interactions between microorganisms and the carrier result in the formation of a compact and stable biofilm, which naturally becomes a more active catalyst of bioconversion processes. Cells have a natural tendency to adhere to surfaces. This feature is of key significance in the cell immobilization method. Its driving force is the deficit of nutrients in the environment. The concentration of nutrients is usually slightly higher near the surface [18]. The choice of an adequate carrier which matches the conditions of the process is decisive to its success. So far, various materials have been tested as carriers in the methane fermentation process, for example, artificial polymers, activated carbon, pine shavings, or natural zeolites [19]. As results from the reference publications, the carrier limited the release and the effect of inhibitors (e.g., ammonia), desensitized cells to changes in the environment (pH, temperature, access to the medium), stabilized the system, and increased the bioconversion of materials.

Lignin is one of the most common renewable substances after cellulose. It is a complex aromatic biopolymer mainly composed of p-coumaryl, coniferyl, and sinapyl alcohols—three fundamental monomers differing in the degree of methoxylation [20]. Due to the valuable properties of the compound, such as porosity, well-developed specific surface area, exceptional absorbency, thermoplasticity, bioactivity, and specific structure, it has been used for various innovative purposes [21,22]. In addition, lignin has been proved to activate pancreatic α -amylase and lipase, where the immobilized enzymes achieved high activity and stability [23]. According to reports, this material has also been used for the synthesis of carrier composites with chitin and silica [24].

In view of the findings listed above and the fact that lignin meets all the requirements of a carrier in the AD process (above all, porosity, but also nontoxicity, biocompatibility, thermal and electrokinetic stability, resistance to hydrolytic enzymes), Pilarska et al. (2018, 2019) tested this biopolymer in the anaerobic breakdown of selected organic waste as a lignin/polyvinylpyrrolidone (PVP) system [25,26]. The author found that it may also be important that lignin is capable of adsorbing heavy metals and other chemical compounds that are potential inhibitors of the AD of sewage sludge [27,28]. Polyvinylpyrrolidone (PVP) is a linear water-soluble polymer, whereas in the cross-linked version it is insoluble, has excellent wetting properties, readily forms biofilms, and is often used in microbiology [29]. The task of PVP is to improve cell adhesion to the carrier surface.

The goal of the study was to verify the amount of biogas/methane produced in anaerobic co-digestion of waste cheese (CE) and waste wafers (WF) with the addition of lignin combined with polyvinylpyrrolidone ($-\text{[CH}_2\text{CH(C}_4\text{H}_6\text{NO)]}_n-$, PVP), and without the carrier—as the control variant. The process was conducted in a laboratory under mesophilic conditions in anaerobic batch digestion reactors. Stabilized sewage sludge was used as the inoculum. During the experiment, the fermenting suspension was analyzed for pH, volatile fatty acids/total alkalinity (VFA/TA), total Kjeldahl nitrogen

(TKN), ammonium nitrogen ($N-NH_4^+$), chemical oxygen demand (COD), and bacterial counts and enzymatic activity.

2. Materials and Methods

2.1. Feedstock and Inoculum

Waste cottage cheese (CE) from a dairy and waste wafers (WF) from a confectionery near Poznań were used as substrates. Stabilized sewage sludge used in the experiment as an inoculum was acquired from the Poznań Central Sewage Treatment Plant (Poznań, Poland). Kraft lignin, which was used as a carrier, and polyvinylpyrrolidone—a carrier modifier, were purchased from Sigma-Aldrich, Steinheim am Albuch, Germany. The physicochemical properties of the waste materials used in the experiment are shown in Table 1.

Table 1. Physicochemical properties of substrates and inoculum used in the experiment.

| Waste | pH | TS | VS | C/N Ratio | C | N | N-NH ₄ | P | Light Metal Ions | | | |
|-------|------|--------|-----------------------|-----------|-----------------------|-----------------------|-----------------------|------------------------|------------------------|------|----|-----|
| | | | | | | | | | K | Na | Mg | Ca |
| | - | (wt %) | (wt % _{TS}) | - | (wt % _{TS}) | (wt % _{TS}) | (wt % _{TS}) | (mg kg ⁻¹) | (mg kg ⁻¹) | | | |
| CE | 4.67 | 24.89 | 95.75 | 3.48 | 52.19 | 15.01 | 0.44 | 1,452 | 351 | 433 | 84 | 849 |
| WF | 6.80 | 82.24 | 98.37 | 46.21 | 41.59 | 0.90 | 0.29 | 152 | 37 | 154 | 49 | 154 |
| Inoc. | 7.19 | 2.15 | 58.33 | 3.33 | 27.68 | 8.32 | 3.86 | 2560 | 3236 | 6300 | 33 | 52 |

TS = total solids. VS = volatile solids Inoc. = Inoculum.

2.2. Experimental Procedure

2.2.1. Sample Preparation

The following control samples and samples with a carrier were tested: WF, WF/lignin, CE, CE/lignin, WF+CE, WF+CE/lignin, inoculum, inoculum/lignin. The content of substrates and inoculum in the batches followed the standard [30] with guidelines for the digestion of organic materials. As recommended, the content of dry organic matter in the inoculum ranged from 1.5% to 2%, whereas the content of dry matter in the batch did not exceed 10% [31]. Table 2 shows the composition of the batches and their most important physicochemical parameters.

Table 2. Composition and selected properties of the substrate/inoculum batches.

| Batch | CE (g) | WF (g) | Lignin+PVP (g) | Inoculum (g) | pH | TS (%) | VS (%) |
|-----------------|--------|--------|----------------|--------------|------|--------|--------|
| WF | - | 14.0 | - | 1186.0 | 7.24 | 4.24 | 70.15 |
| WF/lignin | - | 14.0 | 23.5 | 1186.0 | 7.16 | 4.07 | 67.34 |
| CE | 30.7 | - | - | 1169.9 | 7.38 | 2.73 | 59.29 |
| CE/lignin | 30.7 | - | 23.5 | 1170.3 | 7.04 | 2.76 | 60.47 |
| WF+CE | 4.1 | 7.8 | - | 1189.0 | 7.02 | 2.74 | 58.72 |
| WF+CE/lignin | 4.1 | 7.8 | 23.5 | 1169.9 | 6.78 | 2.75 | 58.84 |
| inoculum | - | - | - | 1200.0 | 7.22 | 3.17 | 69.82 |
| inoculum/lignin | - | - | 23.5 | 1200.0 | 7.13 | 4.85 | 71.01 |

2.2.2. Carrier Preparation

The lignin+PVP cell carrier was prepared by making a wet mechanical connection (with 50 mL H₂O) of 20 g lignin and 3.5 g polyvinylpyrrolidone. The carrier was applied to appropriate substrate/inoculum batches (see Table 2), and then the whole was mixed vigorously. The carrier was added to the mixture at an amount based on data in reference publications [32,33]. The authors of this study made partial physicochemical analysis of the lignin+PVP material in earlier tests [25,26], which showed that it met essential requirements for the microbial carrier in the AD process.

2.2.3. Anaerobic Digester Setup

The anaerobic digestion process was conducted in a multi-chamber bioreactor, shown in Figure 1. In total, there were 24 digestion chambers in this experiment (each sample was tested in triplicate). The capacity of the bioreactors was 1.4 L (5). They were filled with the batch up to 1 L, which was mixed once a day. The bioreactors were located in a water jacket (4) connected to a heater (1), thanks to which the process could be conducted within the set temperature range (mesophilic conditions) [14,34]. The biogas produced in the process flowed (7) to the tanks (8) freely, where it was stored. The hydraulic retention time (HRT) was 21 days. According to the standard [35], the experiment was continued until the daily biogas production in all the bioreactors dropped below 1% of the total amount of biogas produced.

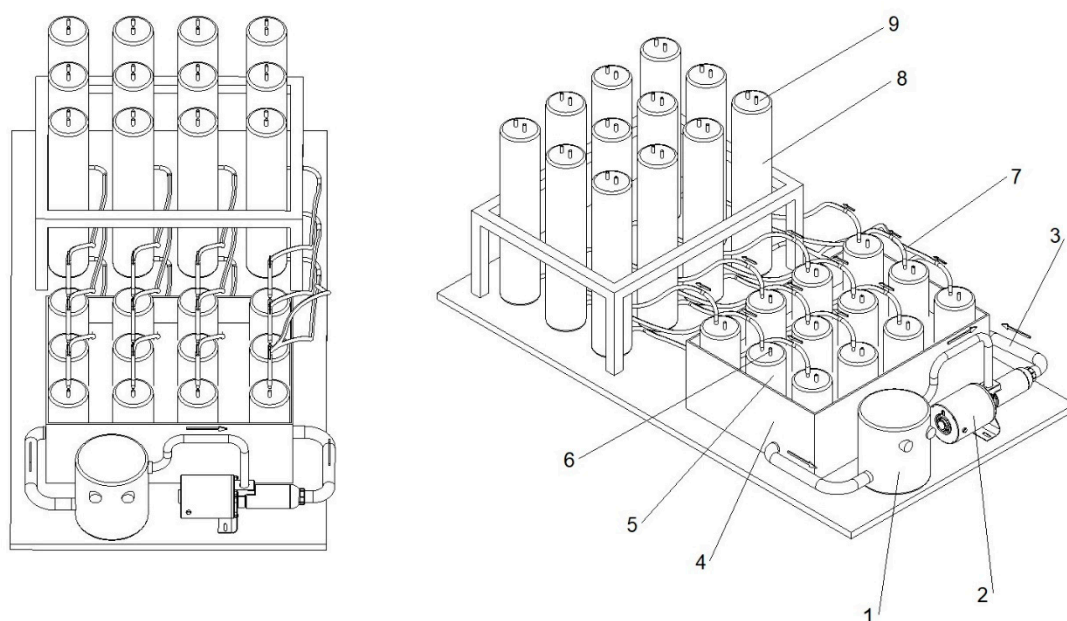

Figure 1. The anaerobic bioreactor (12-chamber section) used in biogas production experiment: 1—water heater; 2—water pump; 3—insulated tubes for heating medium; 4—water jacket (39 °C); 5—bioreactor (1.4 L); 6—slurry sampling valve; 7—tube for biogas transport; 8—graduated tank for biogas; 9—gas sampling valve.

2.2.4. Qualitative and Quantitative Analysis of Biogas

The volume of biogas produced was measured every 24 h. The quantitative composition of biogas was measured with Geotech GA5000 gas instrument [31].

The efficiency of biogas production ($\text{m}^3 \text{Mg}^{-1}$) from dry matter or dry organic matter was estimated according to results of the experiment. The biogas efficiency for individual substrates was calculated by subtraction of the volume of biogas produced from the inoculum alone from the volume of biogas produced from the samples. The equation presented by the authors in earlier studies was used to calculate the cumulative amount of biogas generated from the inoculum (digested sewage sludge) in the bioreactors with a given substrate or mixture of substrates [25,26].

2.3. Analytical Techniques

2.3.1. Physicochemical Analysis

The pH (potentiometric analysis) and electrolytic conductivity of the substrates and batches were analyzed with an Elmetron CP-215. The content of total solids (TS) was measured by drying at 105 °C

(Zalmed SML dryer, Zalmed, Łomianki, Poland). The content of volatile solids (VS) was measured by combustion at 550 °C (MS Spectrum PAF 110/6 furnace, MS Spectrum, Warszawa, Poland) [25].

The substrates and the digested materials were analyzed using the following methods and devices: the carbon content—combustion at 900 °C, CO₂-OI Analytical analyzer; nitrogen—titration, Kjeldahl method with 0.1 n HCl; ammonium nitrogen—distillation and titration with 0.1 n HCl; phosphorus—the mineralization of phosphorus compounds with nitric acid (microwave furnace, Milestone), then by spectrophotometric analysis (Varian Cary 50); chemical oxygen demand (CODr)—titration, dichromate method (potassium dichromate, concentrated sulphuric acid, silver sulphate as catalyst); light metal ions—inductively coupled plasma optical emission spectrometry (ICP-OES, Sysmex, Hoeilaart, Belgium), JY 2000 2 ICP-OES spectrometer (ISA Jobin Yvon, Edison, NJ, USA) [15,36].

The content of VFA (volatile fatty acids), TA (total alkalinity), and the VFA/TA ratio (volatile fatty acids-to-total alkalinity ratio) in the fermenting batch was measured by collecting a 5 mL sample (5 mL of the fermentation substrate). Next, it was titrated with 0.1 N of sulphuric acid solution (H₂SO₄) up to pH 5.0 to calculate the TA value. The VFA value was measured after the second titration step between pH 5.0 and pH 4.4 [15].

The porous structure parameters of the lignin and lignin+PVP material were measured using an ASAP 2420 instrument (Micromeritics Instrument Co., Norcross, GA, USA). Before performing the analysis, the samples were degassed in vacuum at a temperature of 90 °C. The BJH (Barrett–Joyner–Halenda) method was applied to measure the total volume and pore size distribution [25].

Zeta potential values of the kraft lignin and lignin+PVP carrier were measured with a Zetasizer Nano ZS apparatus equipped with an autotitrator (Malvern Instruments Ltd., Cambridge, UK). It was possible to make measurements by combining electrophoresis and laser measurement of particle mobility based on the Doppler effect. In order to measure the electrophoretic mobility, a sample (0.01 g) was suspended in an electrolyte solution with variable ionic strength (25 mL), which was 0.001 M NaCl. Next, the suspension was placed in the autotitrator vessel. The entire system was titrated with 0.2 M HCl and 0.2 M NaOH solutions. pH was controlled by means of a glass electrode [24].

2.3.2. Microbial Analysis

The total count of bacteria in six materials collected during the digestion process was measured with the direct method under a fluorescent microscope (Zeiss), using modified fluorescent in situ hybridization (FISH) according to [37]. Microbiological analyses were made at four terms: I—the 2nd day of the experiment, II—the 4th day of the experiment, III—the 8th day of the experiment, IV—the 14th day of the experiment, V—the 18th day of the experiment, VI—the 20th day of the experiment.

The fermented sludge (0.01 mL) was placed on the surface of slides using a Breed chamber. Next, it was fixed with a 4% PFA solution (paraformaldehyde). After that, the materials were washed in a phosphate buffer solution (PBS) three times and 0.5% Triton solution was added. Then, the samples were washed with the PBS three times again. Next, they were placed in an alcohol series (70%, 80%, 96%). After adding a 70% formamide solution, the genetic probe EUB338 GCT GCC TCC CGT AGG AGT [38] was applied at a concentration of 25 ng μL⁻¹. It was stained with a Cy5 fluorescent dye, suspended in a solution which consisted of: 5M NaCl, 1M Tris/HCl, 25% formamide, 10% SDS, and ddH₂O. The digestate samples were incubated for 24 h in darkness, at 37 °C. Next, the preparations were analyzed with a fluorescence microscope equipped with an AxioCam MRc5 color digital camera. The image was analyzed by means of the AxioVision 4.8 software (AxioVision LE 4.8 2.0, Carl Zeiss Microscopy, LLC, White Plains, NY, USA) [25].

At the last term of analyses (VI), the count of methane microorganisms of the *Archaea* domain was measured using the fluorescence in situ hybridization method. The microorganisms in the fermented waste samples were detected with the ARCH915 GTG CTC CCC CGC CAA TTC CT probe, proposed by [39], stained with the Cy5 dye, which was used to detect these microorganisms in the fermented waste samples under analysis.

2.3.3. Biochemical Analysis

The samples were analyzed biochemically using the spectrophotometric method. The dehydrogenase activity (DHA) was measured with the method developed by [40], with some modifications. The samples (5 mL) were incubated for 24 h with 2,3,5-triphenyltetrazolium chloride (TTC) at 30 °C, pH 7.4. Triphenylformazan (TPF) was produced, extracted with 96% ethanol, and measured spectrophotometrically at 485 nm. The dehydrogenase activity was presented in units $\mu\text{mol TPF g}^{-1} \text{ DM of waste } 24 \text{ h}^{-1}$ [41].

2.3.4. Statistical Analysis

The Statistica 12.0 program (Statistica, formerly-StatSoft Inc., Oklahoma, OK, USA) was used for statistical analyses. Two-way analysis of variance was used to determine the significance of variation in the count and activity of the microorganisms, depending on the experimental variant and the term of the analysis.

A stepwise regression procedure descending from the fifth grade was used to present the results of microbial and enzymatic analyses so as to select the multiple regression model. The coefficient of determination R^2 was used to fit the model. Pearson's linear correlation coefficient was calculated to identify the type of dependence between the count and activity of microorganisms and the chemical parameters of waste fermented.

3. Results and Discussion

3.1. Physicochemical Properties of Substrates

The waste cheese (CE) used in the experiment was primarily a source of organic matter and macroelements, as indicated by VS (95.75 wt%_{TS}) and chemical oxygen demand (86.58 mg L⁻¹)—see Table 1. What might be a matter of concern with this type of waste is its high content of calcium (849 mg kg⁻¹) and sodium (433 mg kg⁻¹) (Table 1). Excessive amounts of calcium, whose range cannot be reached (according to data from reference publications) in waste cheese [42], cause the precipitation of carbon and phosphate and the formation of mill scale in reactors. As far as the value obtained in this study is concerned, calcium will only favor the formation of cell aggregates.

There is a relatively high concentration of sodium in cheese and cheese waste, including quark, due to their salt content [3,4]. Sodium in the anaerobic digestion system may easily affect the activity of microorganisms and disturb their metabolism. At low concentrations, that is, 230–350 mg L⁻¹, sodium is necessary for methanogens to form adenosine triphosphate and oxidize NADH [42]. Potential problems arising from a slightly elevated sodium level in CE (Table 1) and the acidic pH of this substrate (pH = 4.67) can be solved by using confectionery waste as a co-substrate (neutralizing and complementary composition), buffering sewage sludge and the lignin microbial carrier.

The physicochemical properties of waste wafers (WF) and digested sewage sludge (inoculum) were characterized in detail by the first author in earlier publications [14,15,25,26]. Generally, WF are characterized by approximately neutral pH, considerable content of total solids (TS) and volatile solids (VS), and a high C/N ratio (see Table 1), which contributes to their high biochemical methane potential (BMP) [15]. The concentration of ammonium nitrogen (N-NH₄⁺) and light metals does not exceed the critical values [39] for the stability of anaerobic digestion (AD). On the contrary, it favors the development and activity of methanogenic consortia [14,26]. The main advantage of stabilized sewage sludge is its high buffer capacity due to its considerable alkalinity developed in the raw sewage sludge digestion process, where nitrates were reduced to carbonates and hydrogencarbonates (total denitrification) [43].

3.2. Carrier Characteristics

At present, scientists in many centers all over the world are conducting numerous studies on the physicochemical and structural properties of lignin [44–46]. Pilarska et al. (2018) also presented the

results of a wide range of analyses in another article on the use of lignin and lignin combined with PVP as a cell carrier [25].

Spectroscopic analysis proved that the combination of lignin with PVP had a physical nature and affected its surface properties rather than its chemical ones. The absence of chemical bonds between the carrier and the modifier should be explained by the non-stoichiometric ratio of both compounds. However, surface effect was the only role of the modifier.

Observations with SEM images showed that both materials tended to form irregularly shaped particle aggregates with a clearly mesoporous structure [25]. Irregular microstructures and troughs favor cell adhesion. At a later stage they favor cell colonization on the surface of the carrier.

As the results showed, the relatively well-developed specific surface area of lignin ($1.9 \text{ m}^2/\text{g}$) and lignin+PVP ($2.5 \text{ m}^2/\text{g}$), [25] is an indispensable attribute of an effective carrier. Moreover, large pores with diameters up to 20 nm can be seen in Figure 2, which shows the pore size distribution of lignin and lignin+PVP.

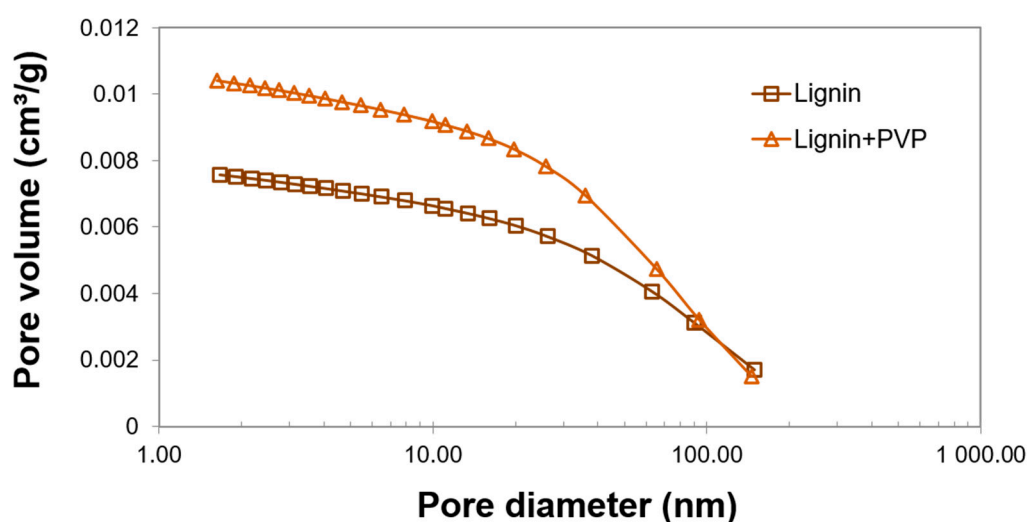

Figure 2. Pore size distribution of the pure and grafted lignin.

The knowledge of the thermal stability of lignin and lignin+PVP is important because sometimes the AD process takes place under thermophilic conditions. Pilarska et al. (2018) interpreted the results of a thermal gravimetric analysis and differential thermal gravimetric analysis in detail and they proved the high thermal stability of both materials [25]. The first signal of a weight loss of 2.7%–3.9% was recorded only at a temperature of about 200 °C.

Due to various conditions of methane fermentation, including those where adverse changes in the pH of the environment (from acidic to alkaline) may occur, it is recommended to verify the electrokinetic stability of lignin combined with PVP (see Figure 3). The knowledge of the zeta potential value, the parameter which is a measure of electrostatic interactions between particles, enables estimation of the stability of the colloidal dispersion of the system, which is understood as a limited tendency to coagulate particles. In water systems, the limit value of zeta potential of about $\pm 30 \text{ mV}$ is assumed to determine the electrokinetic stability of dispersion. When this parameter is equal to zero, the system is in a state of full coagulation. The value at which the zeta potential is equal to zero is called the isoelectric point (IEP) [47].

Kraft lignin, like kraft lignin combined with PVP, exhibited negative zeta potential values (from -40 mV to -25 mV) over the entire pH range under analysis (see Figure 3). The negative surface charge is a consequence of surface ionization of hydroxyl and acid groups, resulting from the dispersion of lignin in aqueous solutions. The distribution of the obtained measurement points proved that both materials exhibited high electrokinetic stability within a wide pH range, that is, from 4 to 11. This

observation is in line with data provided in relevant publications [24,45]. The shape of electrokinetic curves suggests that both materials tend to achieve IEP at a pH close to 1 [45].

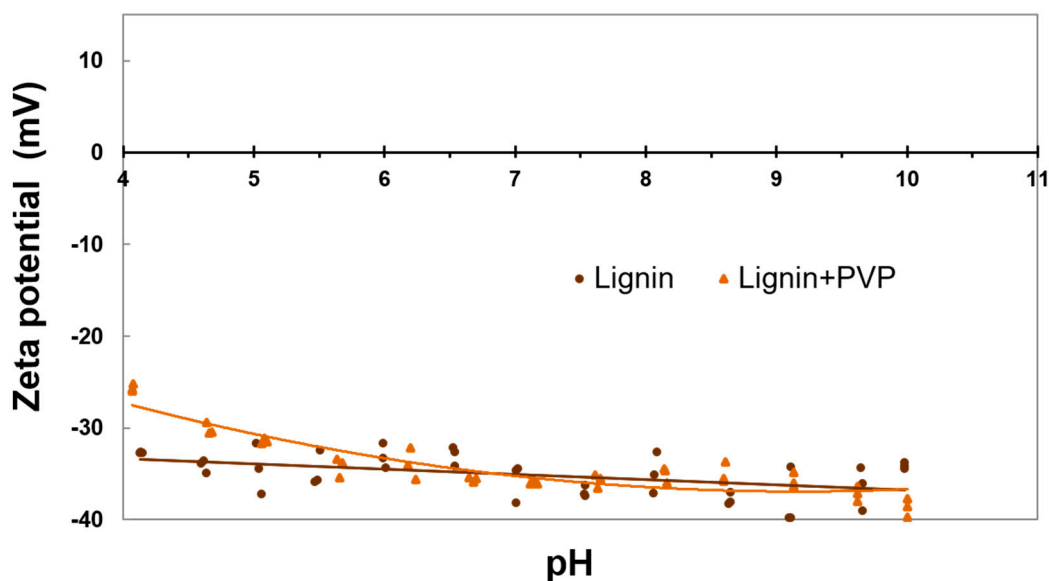
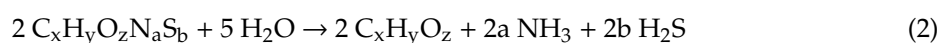

Figure 3. Electrokinetic stability of the pure and grafted lignin.

3.3. Batch Experiments

3.3.1. Digestion Process Monitoring

The monitoring of the process stability involved measuring pH and the VFA/TA ratio (volatile fatty acids-to-total alkalinity ratio). As results from the publications, the optimal pH range for the growth of methanogens is 6.5–7.2 [15,42,48]. In none of the samples pH dropped to 6.5, which indicates the accumulation of volatile fatty acids and acidification of the environment (Figure 4). However, an increase in pH to a maximum of 7.55 was noted, especially in the samples containing cheese waste. The increase in pH resulted from the decomposition of milk protein—casein, which was accompanied by the release of ammonia [3]. The equations below apply to hydrolysis (1) and acidogenic phase (2):



Apart from the VFA concentration, the volatile fatty acids/total alkalinity (VFA/TA) ratio is commonly used to assess the process stability. The curves corresponding to variation in the VFA/TA ratio during the decomposition of substances in individual samples show that the process proceeded without inhibition, according to the assumed ranges of values specifying stable digester and some instability [15,43] (Figure 4). The highest VFA/TA ratio of 4.9 was noted for the combination of the co-substrates with lignin (WF+CE/lignin). However, after 7 days it dropped to 0.4, which is the process stability limit value. The VFA/TA ratio shows that the decomposition of both CE and WF+CE was particularly stable. These results are correlated with the chemical oxygen demand (COD_r) values, which began to decrease on the fourth (CE, CE/lignin, WF+CE) or eighth day (WF/lignin, WF+CE/lignin, inoculum, inoculum/lignin), depending on the sample (Figure 5).

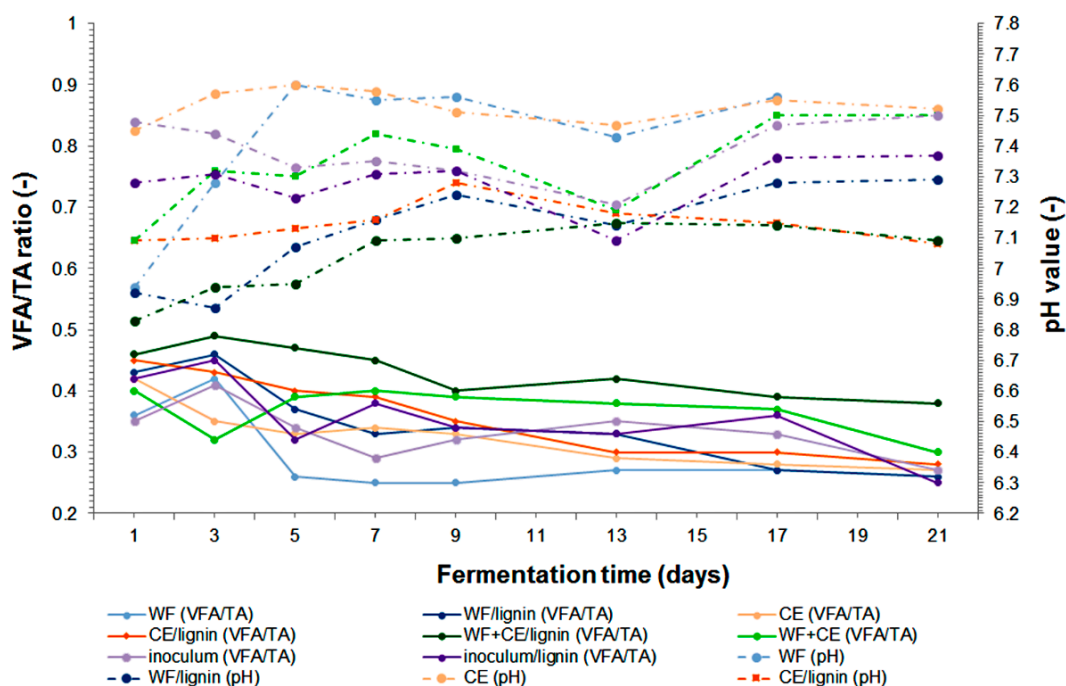

Figure 4. Changes in the pH and VFA/TA ratio during the anaerobic digestion of the samples under analysis. TA: total alkalinity.

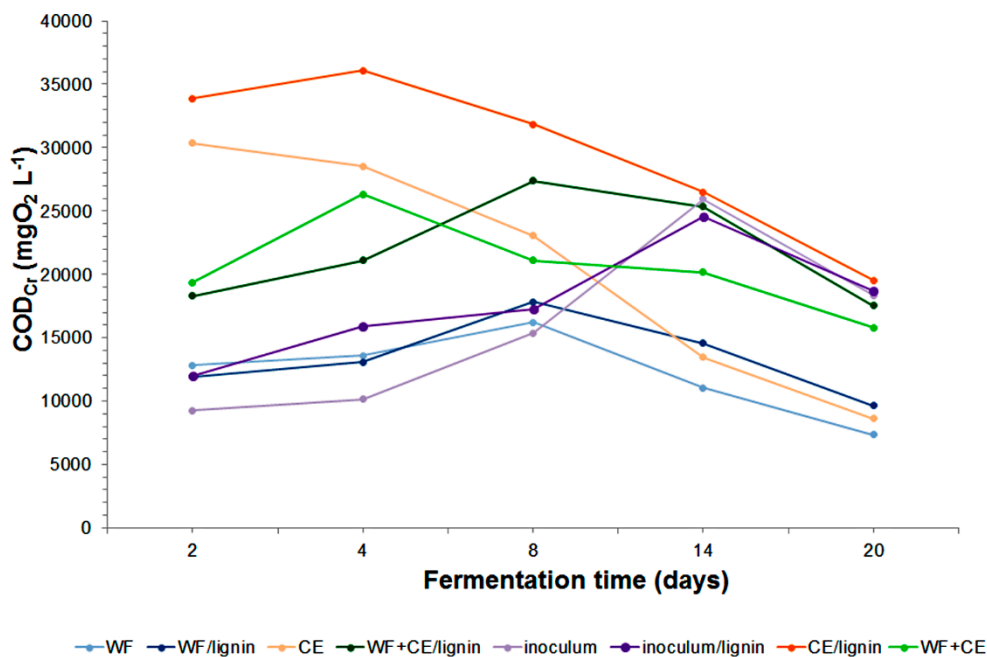

Figure 5. Changes in the COD_{Cr} during anaerobic digestion of the samples tested.

The effective removal of VS from the system was confirmed by a decrease in the amount of oxygen consumed by oxidation reactions, mainly organic matter. The best removal efficiency of the total COD_{Cr}, that is, 71.5%, was noted for the CE. It was 42.4% for the CE/lignin, and a comparable value, that is, 42.8%, for the WF. There were similar results of experiments where whey cheese was a substrate [9,10].

The decomposition of organic matter also releases nitrogen compounds. The analysis of changes in nitrogen forms occurring during anaerobic digestion is particularly important when protein substrates

and sewage sludge are used. In the process of anaerobic decomposition of organic substances, organic nitrogen is converted into ammonium nitrogen, whereas part of organic nitrogen is bound in biomass [49]. The efficiency of ammonium nitrogen formation depends on the digestion chamber load and the process temperature [50]. Snell (1943) was the first to observe that during the decomposition of proteins, 75%–90% of organic nitrogen was converted into ammonium nitrogen [51].

It is justified to make a simultaneous analysis of the total Kjeldahl nitrogen (TKN) content. Its value is the sum of ammonium nitrogen and organic nitrogen, and separately, ammonium nitrogen ($N-NH_4^+$), in the decomposed material (see Figures 6 and 7).

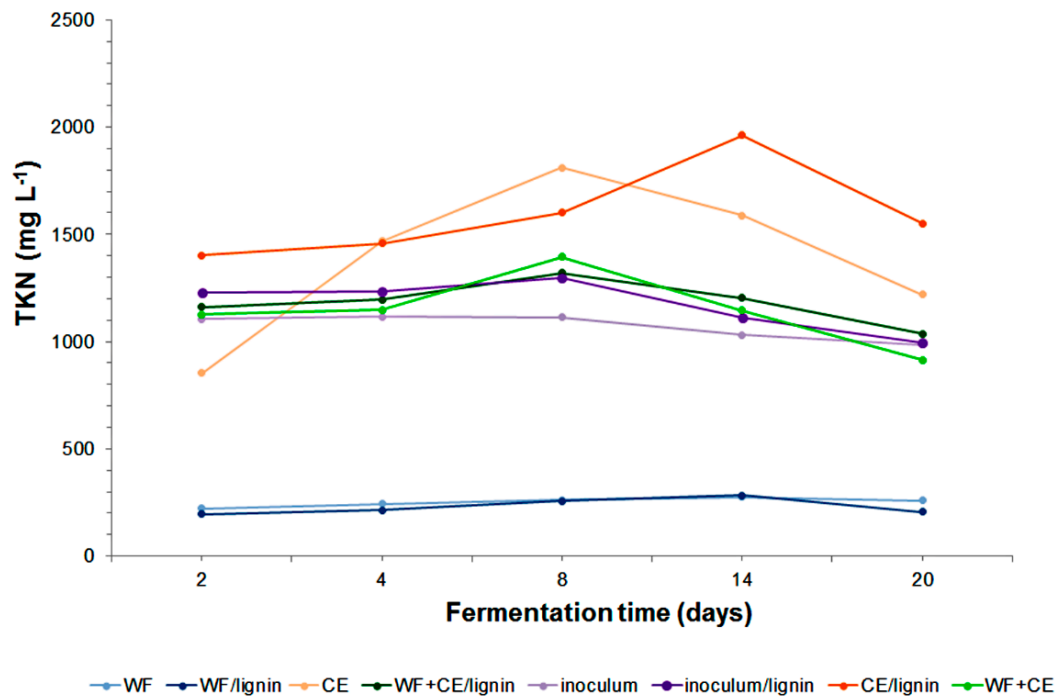

Figure 6. Changes in the TKN (total Kjeldahl nitrogen) during anaerobic digestion of the samples tested.

The TKN concentration increased systematically in all the systems at the phases of dynamic decomposition of organic matter contained in the samples (Figure 6). The results of the analysis of the $N-NH_4^+$ content in the samples showed that its concentration had increased as a result of the conversion of organic nitrogen into ammonium nitrogen (Figure 7). The maximum $N-NH_4^+$ content in the TKN in the digestates with wafers and the ones containing wafers with the lignin–PVP carrier was 83%. The content of ammonium nitrogen in TKN in the samples containing only waste cheese was as high as 92%. This value proved that organic nitrogen had been effectively converted and it was in agreement with data provided in reference publications [48]. The analysis of the ammonium nitrogen concentration in the sample with the WF+CE co-substrates per TKN concentration revealed an even higher value at the last phase of the process—98%. Therefore, the addition of the wafer co-substrate improved the degradation. According to Chen et al. (2013), the concentration of $N-NH_4^+$ produced during the experiment did not threaten the activity or development of microorganisms [42]. The general distribution of the values was consistent with the results reported by other authors [52].

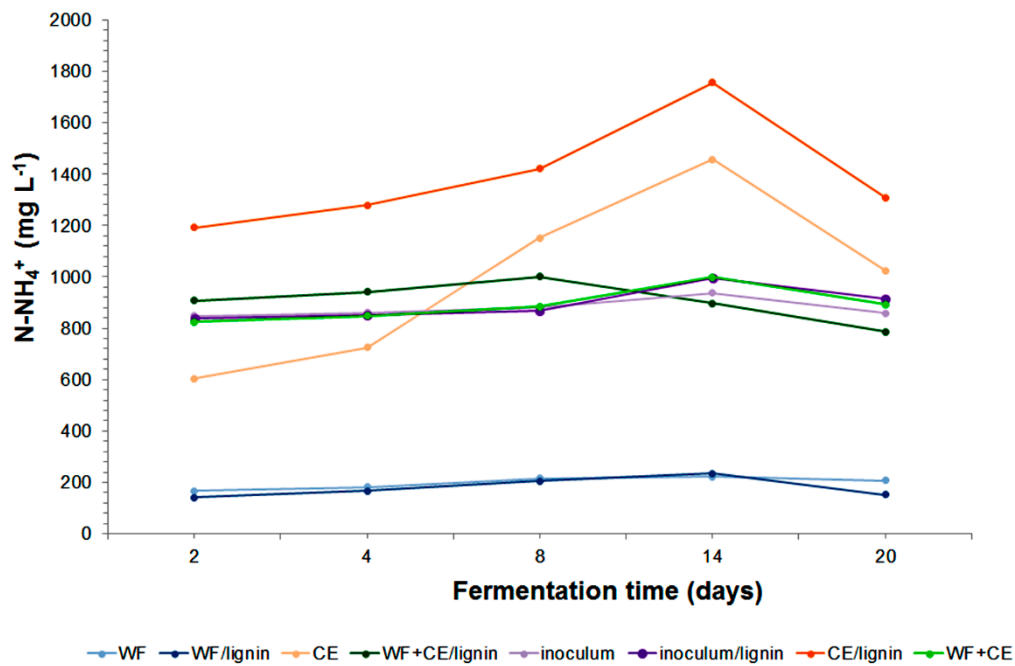

Figure 7. Variation in the N-NH₄⁺ during anaerobic digestion of the samples tested.

3.3.2. Bacterial Count and Enzymatic Activity

The results of the research on the influence of three types of organic waste (including the inoculum) and the lignin carrier on the total count of bacteria and the dehydrogenase activity were analyzed statistically. The two-way analysis of variance showed that the factors under analysis had highly significant influence ($p = 0.001$) on the dynamics of variation in the count and activity of bacteria. The multiple regression analysis showed that the second degree model was the best for both the cell count and microbial activity—the coefficient of determination R^2 for the square model had the highest values (see Figures 8 and 9).

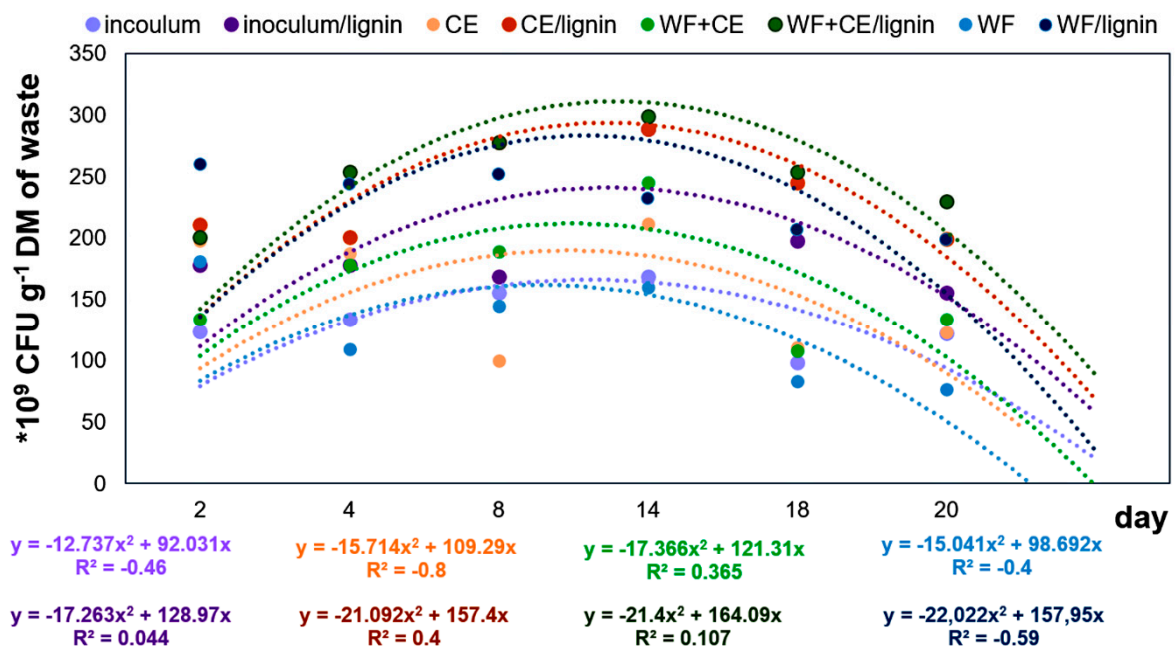

Figure 8. Changes in the total count of bacteria in the samples digested.

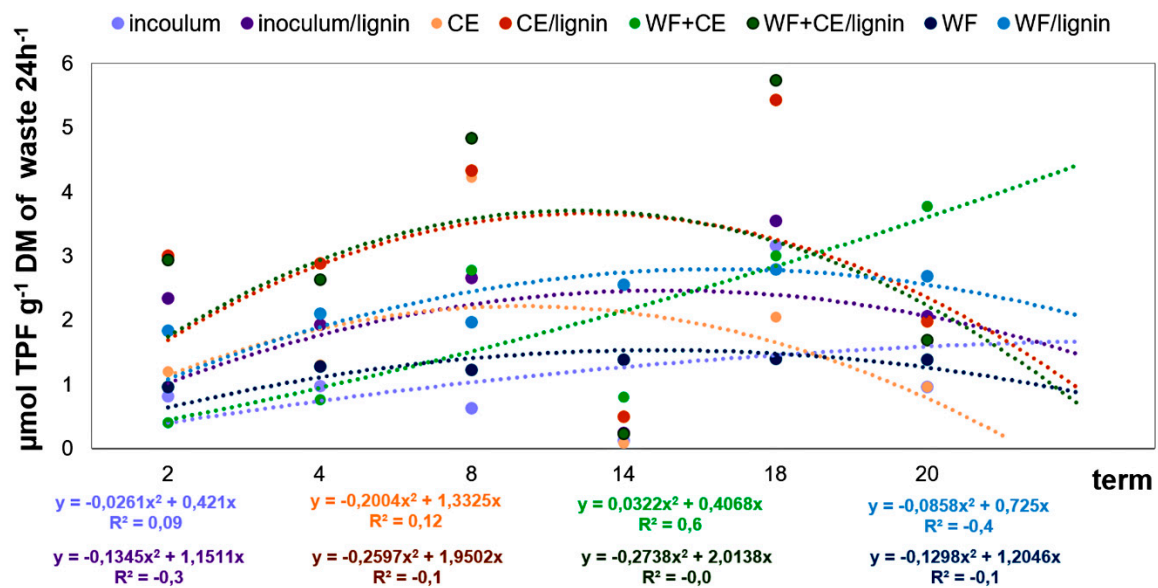

Figure 9. Changes in the dehydrogenase activity (DHA) in the samples digested.

The results of the experiment showed that during the process, the highest count of eubacteria (Figures 8 and 10) was found in the WF+CE/lignin sample, which consisted of waste wafers co-digested anaerobically with waste cheese and the lignin+PVP carrier. It is most likely that this phenomenon was caused by the pH value (pH ~7), which remained the most favorable for bacterial growth and development during the decomposition of material in this variant (Figure 4). This fact was also confirmed by the relatively high value of Pearson's linear correlation coefficient (see Table 3).

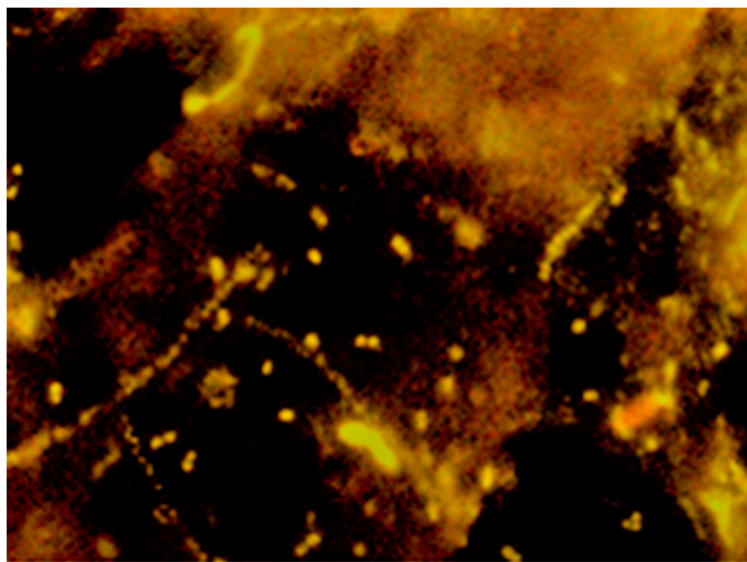

Figure 10. Specific identification of whole fixed bacterial cells with fluorescent oligonucleotide probes (FISH)—WF + CE/lignin combination (400x magnification).

The waste cheese fermented with the CE/lignin carrier was another sample with a high bacterial count (Figure 8). There was a positive correlation between the count of bacteria and the content of ammonium nitrogen ($N-NH_4^+$) in the digestate (Table 3). Ammonium nitrogen is significant for the course of anaerobic digestion. On the one hand, it is the nutrient substance of anaerobic microorganisms. On the other hand, it ensures partial alkalinity of the anaerobic digestion system [53]. As mentioned

before, $N-NH_4^+$ has a beneficial effect on condition its concentration does not exceed the value causing the inhibition of the AD process [42].

Table 3. Pearson correlation coefficient between bacteria number, DHA activity, and chemical parameters of samples applied in the experiment at consecutive terms of analysis.

| Parameters | WF | WF/Lignin | CE | CE/Lignin | WF+CE | WF+CE/Lignin | Inoculum | Inoculum/Lignin |
|------------------------|--------|-----------|-------|-----------|-------|--------------|----------|-----------------|
| Bacteria Number | | | | | | | | |
| $N-NH_4^+$ | -0.19 | 0.21 | -0.13 | 0.81 * | 0.67 | 0.31 | 0.81 * | 0.80 * |
| TKN | -0.19 | 0.24 | -0.23 | 0.79 | 0.60 | 0.47 | 0.41 | -0.14 |
| pH | -0.46 | -0.69 | -0.44 | 0.98 * | -0.42 | 0.74 | -0.88 * | -0.92 * |
| DHA | -0.70 | -0.93 * | -0.73 | -0.03 | -0.33 | -0.28 | -0.85 * | -0.70 |
| DHA | | | | | | | | |
| $N-NH_4^+$ | 0.75 | 0.03 | -0.03 | -0.56 | 0.08 | -0.23 | -0.49 | -0.57 |
| TKN | 0.79 | 0.01 | 0.44 | -0.56 | -0.04 | -0.26 | -0.46 | -0.08 |
| pH | 0.86 * | 0.67 | 0.24 | -0.22 | 0.79 | 0.13 | 0.54 | 0.86 * |

Explanation: *—the correlation between the tested parameters is statistically significant with probability $p = 0.05$; DHA—dehydrogenase activity, TKN—Total Kjeldahl Nitrogen.

The results of the microbiological tests showed intensified influence of the type of waste used (and its combinations) with or without the carrier on the count of bacteria in the following gradation: $WF+CE > CE > inoculum \geq WF$.

The analysis of the influence of the carrier alone on the proliferation of bacteria showed that the cell count in the experimental variants enriched with lignin was 31%–46% higher. This finding was in line with the results of earlier studies conducted by the same authors [25,26]. The beneficial effect of lignin results from its sorption properties, which extend the activity and stability of the consortium of microorganisms by protecting them from changes in pH, temperature, and composition of the substrate [23,54]. The activating effect of the lignin+PVP carrier could also be attributed to its specific irregular microstructure, ensuring stable contact between lignin and cells. It is said that the cell binding to lignin has covalent nature. Lalov et al. [55] made the same hypothesis when they applied granulated polymeric support (poly(acrylonitrile-acrylamide)). As far as lignin is concerned, it will most likely be the bond formed by the combination of hydroxyl and hydroxymethyl groups from the lignin and amino groups from the cells. This statement will be verified in another study by Pilarska et al.

The experimental combination type was an important parameter influencing the count of methane microorganisms of the *Archaea* domain (Figure 11). The microbiological analysis of the fermented materials made at the last term showed the highest statistically significant count of methane bacteria in the WF/lignin sample. Apart from that, lignin had no statistically significant effect on the count of bacteria in most of the experimental variants.

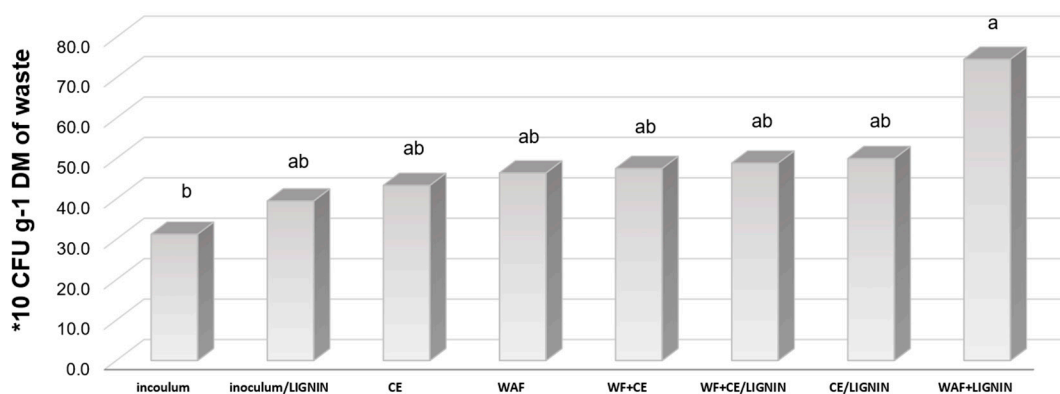

Figure 11. The count of *Archaea* in the samples subjected to anaerobic digestion at the last term of analyses.

Figure 9 shows the results of biochemical analyses. Like in the case of the bacterial count, the highest dehydrogenase activity level was found in the WF+CE/lignin and CE/lignin samples. The DHA, which is considered a very important indicator of the intensity of respiratory metabolism, mainly in active microorganisms, is positively correlated with the content of organic matter and with the count of microorganisms [56]. However, the results of our research showed that the DHA was negatively correlated with the bacterial count (Table 3). In most of the variants, the DHA was increasing successively until the 14th day of the experiment. Then, the value of this parameter began to decrease. This phenomenon is most likely to have been caused by the secretion of specific process inhibitors, such as hydrogen sulphide, during the biodegradation of matter [3,53]. The maximum DHA was observed on the 18th day of the experiment, especially in the aforementioned variants: WF+CE/lignin and CE/lignin.

The biochemical analysis of the fermented waste showed that lignin positively affected the DHA in all the experimental variants. This fact proves that carriers stabilize the structure of enzymatic proteins [17].

3.3.3. Process Performance

Table 4 shows the amount of biogas obtained from the waste cheese (quark) (CE) calculated per organic substance, that is, $881.26 \text{ m}^3 \text{ Mg}^{-1} \text{ VS}$, where the share of methane was $556.42 \text{ m}^3 \text{ Mg}^{-1} \text{ VS}$. This is a very good result, comparable with the yield from buttermilk and much better than the yield from whey due to the higher TS and differences in the chemical composition, including a considerable content of fat [1,3,16]. The efficiency of anaerobic digestion of CE is also comparable with that of food waste from restaurants and canteens [57]. The efficiency of biogas production from confectionery waste or stuffed wafers alone was verified and discussed in detail in earlier publications by Pilarska et al. (2018, 2019) [14,15].

Table 4. Total biogas and methane performance.

| Batch | Biogas | | Methane | | CH ₄ (%) |
|-----------------|--------------------------------------|--------------------------------------|--------------------------------------|--------------------------------------|---------------------|
| | (m ³ Mg ⁻¹ FM) | (m ³ Mg ⁻¹ VS) | (m ³ Mg ⁻¹ FM) | (m ³ Mg ⁻¹ VS) | |
| WF | 866.33 | 897.22 | 479.16 | 496.39 | 55.31 |
| WF/lignin | 966.28 | 1201.45 | 551.34 | 685.53 | 57.06 |
| CE | 210.04 | 881.26 | 132.61 | 556.42 | 63.14 |
| CE/lignin | 235.87 | 989.65 | 151.43 | 635.36 | 64.20 |
| WF+CE | 674.48 | 1102.00 | 349.83 | 571.57 | 51.87 |
| WF+CE/lignin | 769.58 | 1257.38 | 402.18 | 657.68 | 52.26 |
| inoculum | 1.51 | 120.07 | 0.94 | 74.90 | 62.38 |
| inoculum/lignin | 1.29 | 170.43 | 2.14 | 103.10 | 60.49 |

FM: fresh matter.

The co-substrate system with waste wafers and waste cheese was tested for the first time. The combination of WF with CE gave very good results: $1102.00 \text{ m}^3 \text{ Mg}^{-1} \text{ VS}$ of biogas with almost 52% of methane ($571.57 \text{ m}^3 \text{ Mg}^{-1} \text{ VS}$). Figure 12 illustrates a successive increase in the accumulated biogas—the process was not inhibited. The analyses of pH, the VFA/TA ratio, TKN, and N-NH_4^+ showed that the matter contained in the WF+CE sample was decomposed stably and effectively (see Figures 4, 6 and 7). The results proved the occurrence of synergistic effects between these two materials. There is a good prognosis for the implementation of this solution in industrial production. The analysis and comparison of the earlier results show that dairy waste proved to be a better co-substrate for waste wafers than sewage sludge [14,25].

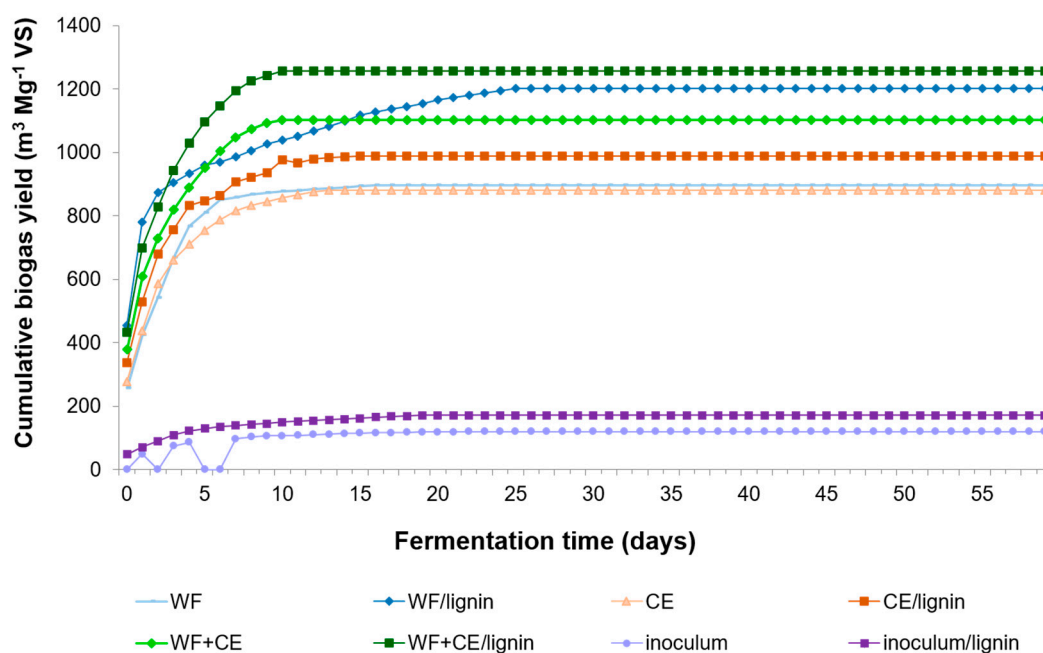

Figure 12. Cumulative biogas production curves from VS of the samples tested.

The addition of lignin to the WF+CE system aided the microorganisms catalyzing the bioconversion process and increased the yield of biogas and methane by 15% (Table 4). This phenomenon was correlated with the results of microbiological and biochemical analyses, which showed that the combining of WF and CE as co-substrates resulted in the highest count of bacteria and the highest dehydrogenase activity of all the experimental variants.

The research showed that due to the properties of lignin, it could be used as a cell carrier in the AD process [25,26]. So far, other researchers have mainly focused on assessing the activation and stabilization of specific enzymes by lignin. For example, lignin was proved to activate α -amylase and lipase [58], where lipase could be immobilized on cellulose/lignin beads [59] or on the chitin/lignin composite [23]. Gong et al. (2017) used lignin extracted from bamboo shoot shells (BBS) to activate and α -amylase immobilization [54]. The authors attributed the active effect of lignin to its rough and relatively well-developed surface, where numerous cavities ensure optimal distribution and stable contact between starch and the enzyme. Researchers observed that lignin-immobilized enzymes were characterized by higher catalytic efficiency and storage stability than their free counterparts [51,58,59]. The observations made in the earlier studies [25,26] and the results of the current microbiological and biochemical analyses lead to a similar conclusion.

4. Conclusions

The authors once again confirmed that lignin combined with PVP had beneficial effect on the count of microorganisms and enzymatic activity. This study supplements the results of physicochemical analyses of lignin+PVP. They confirmed its mesoporous structure and high electrokinetic stability within a wide pH range from 4 to 11.

The combined cheese and confectionery waste gave very successful results. The compositions of WF and CE waste complement each other and give synergistic effects. The buffering alkaline pH resulting from the release of $N-NH_4^+$ during the AD of cheese waste may prevent acidification, which accompanies the breakdown of carbohydrates. The course of the decomposition process was stable in all the samples, not only due to the selection of the right substrates, but also due to the stable sewage sludge. At the last phases of the process, the share of $N-NH_4^+$ in TKN exceeded 90%, especially in the samples with the CE. This fact confirmed the conversion of organic nitrogen to ammonium

nitrogen during the process and effective degradation of organic matter (especially in the WF+CE and CE samples).

The lignin+PVP cell carrier intensified favorable conditions in the anaerobic bioreactor and improved the biogas efficiency. The biochemical analyses showed that eubacteria proliferated intensively and the dehydrogenase activity increased in the samples containing the carrier, especially in the combination with two co-substrates (WF+CE/lignin) and in the waste cheese sample (CE/lignin). Interestingly, there was a positive correlation between the count of bacteria and the content of ammonium nitrogen ($N-NH_4^+$) produced during the decomposition of the CE/lignin material. The biogas production grew from 1102.00 to 1257.38 $m^3 Mg^{-1} VS$ (including 52.26% CH_4) in the WF+CE/lignin combination, and from 881.26 $m^3 Mg^{-1} VS$ to 989.65 $m^3 Mg^{-1} VS$ (including 64.20% CH_4) in the CE/lignin combination.

It is recommended to continue research to confirm the nature of the interactions between cells and lignin. Apart from that, it is necessary to supplement research on the removal of heavy metals from fermented sewage sludge and tests on the absorption of other chemicals contained in potential substrates, which inhibit the AD process.

Author Contributions: Conceptualization, A.A.P.; Data curation, K.P. (Krzysztof Pilarski) and D.J.; Formal analysis, K.P. (Krzysztof Przybył) and M.G.-W.; Investigation, A.W.-M., K.P. (Krzysztof Pilarski) and D.J.; Methodology, A.A.P. and A.W.-M.; Resources, A.A.P. and A.W.-M.; Supervision, M.G.-W.; Visualization, K.P. (Krzysztof Przybył); Writing—original draft, A.A.P.

Funding: This research received no external funding.

Conflicts of Interest: The authors declare no conflicts of interest.

References

1. Fontana, A.; Campanaro, S.; Treu, L.; Kougias, P.G.; Cappa, F.; Morelli, L.; Angelidaki, I. Performance and genome-centric metagenomics of thermophilic single and two-stage anaerobic digesters treating cheese wastes. *Water Res.* **2018**, *134*, 181–191. [[CrossRef](#)] [[PubMed](#)]
2. Hassan, A.N.; Nelson, B.K. Invited review: Anaerobic fermentation of dairy food wastewater. *J. Dairy Sci.* **2012**, *95*, 6188–6203. [[CrossRef](#)] [[PubMed](#)]
3. Pilarska, A.A.; Pilarski, K.; Witaszek, K.; Waliszewska, H.; Zborowska, M.; Waliszewska, B.; Kolasiński, M.; Szwarc-Rzepka, K. Treatment of dairy waste by anaerobic digestion with sewage sludge. *Ecol. Chem. Eng. S* **2016**, *23*, 99–115. [[CrossRef](#)]
4. Prazeres, A.R.; Carvalho, F.; Rivas, J. Cheese whey management: A review. *J. Environ. Manag.* **2012**, *110*, 48–68. [[CrossRef](#)] [[PubMed](#)]
5. Vlyssides, A.G.; Tsimas, E.S.; Barampouti, E.M.P.; Mai, S.T. Anaerobic digestion of cheese dairy wastewater following chemical oxidation. *Biosyst. Eng.* **2012**, *113*, 253–258. [[CrossRef](#)]
6. Rico, C.; Muñoz, N.; Fernández, J.; Rico, J.L. High-load anaerobic co-digestion of cheese whey and liquid fraction of dairy manure in a one-stage UASB process: Limits in co-substrates ratio and organic loading rate. *Chem. Eng. J.* **2015**, *262*, 794–802. [[CrossRef](#)]
7. Fernández, C.; Cuetos, M.J.; Martínez, E.J.; Gómez, X. Thermophilic anaerobic digestion of cheese whey: Coupling H_2 and CH_4 production. *Biomass Bioenerg.* **2015**, *81*, 55–62. [[CrossRef](#)]
8. Seo, Y.H.; Yun, Y.M.; Lee, H.; Han, J.I. Pretreatment of cheese whey for hydrogen production using a simple hydrodynamic cavitation system under alkaline condition. *Fuel* **2015**, *150*, 202–207. [[CrossRef](#)]
9. Basak, B.; Fatima, A.; Jeon, B.H.; Ganguly, A.; Chatterjee, P.K.; Dey, A. Process kinetic studies of biohydrogen production by co-fermentation of fruit-vegetable wastes and cottage cheese whey. *Energy Sustain. Dev.* **2018**, *47*, 39–52. [[CrossRef](#)]
10. Maragkaki, A.E.; Vasileiadis, I.; Fountoulakis, M.; Kyriakou, A.; Lasaridi, K.; Manios, T. Improving biogas production from anaerobic co-digestion of sewage sludge with a thermal dried mixture of food waste, cheese whey and olive mill wastewater. *Waste Manag.* **2018**, *71*, 644–651. [[CrossRef](#)]
11. Szaja, A.; Montusiewicz, A. Enhancing the co-digestion efficiency of sewage sludge and cheese whey using brewery spent grain as an additional substrate. *Bioresour. Technol.* **2019**, *291*, 121863. [[CrossRef](#)] [[PubMed](#)]

12. Xie, S.; Wickham, R.; Nghiem, L.D. Synergistic effect from anaerobic co-digestion of sewage sludge and organic wastes. *Int. Biodeterior. Biodegrad.* **2017**, *116*, 191–197. [[CrossRef](#)]
13. Rusín, J.; Kašáková, K.; Chamrádová, K. Anaerobic digestion of waste wafer material from the confectionery production. *Energy* **2015**, *85*, 194–199. [[CrossRef](#)]
14. Pilarska, A.A. Anaerobic co-digestion of waste wafers from the confectionery production with sewage sludge. *Polish J. Environ. Stud.* **2018**, *27*, 237–245. [[CrossRef](#)]
15. Pilarska, A.A.; Pilarski, K.; Wolna-Maruwka, A.; Boniecki, P.; Zaborowicz, M. Use of confectionery waste in biogas production by the anaerobic digestion process. *Molecules* **2019**, *24*, 37. [[CrossRef](#)]
16. Pagliano, G.; Ventorino, V.; Antonio Panico, A.; Romano, I.; Francesco Pirozzi, F.; Pepe, O. Anaerobic process for bioenergy recovery from dairy waste: Meta-analysis and enumeration of microbial community related to intermediates production. *Front. Microbiol.* **2019**, *9*. [[CrossRef](#)]
17. Dzionek, A.; Wojcieszńska, D.; Guzik, U. Natural carriers in bioremediation: A review. *Electron. J. Biotechnol.* **2016**, *23*, 28–36. [[CrossRef](#)]
18. Guisan, J.M. *Methods in Biotechnology: Immobilization of Enzymes and Cells*, 2nd ed.; Humana Press: Totowa, NJ, USA, 2006.
19. Purnomo, C.W.; Mellyanawaty, M.; Budhijanto, W. Simulation and experimental study on iron impregnated microbial immobilization in zeolite for production of biogas. *Waste Biomass Valorization* **2017**, *8*, 2413–2421. [[CrossRef](#)]
20. Gellerstedt, G. Softwood kraft lignin: Raw material for the future. *Ind. Crops Prod.* **2015**, *77*, 845–854. [[CrossRef](#)]
21. Liu, Z.; Xu, D.; Xu, L.; Kong, F.; Wang, S.; Yang, G. Preparation and characterization of softwood kraft lignin copolymers as a paper strength additive. *Polymers* **2018**, *10*, 743. [[CrossRef](#)]
22. Qin, Y.; Lin, X.; Lu, Y.; Wu, S.; Yang, D.; Qiu, X.; Fang, Y.; Wang, T. Preparation of a low reducing effect sulfonated alkali lignin and application as dye dispersant. *Polymers* **2018**, *10*, 982. [[CrossRef](#)]
23. Zdarta, J.; Meyer, A.S.; Jesionowski, J.; Pinelo, M. A general overview of support materials for enzyme immobilization: Characteristics, properties, practical utility. *Catalysts* **2018**, *8*, 92. [[CrossRef](#)]
24. Ciesielczyk, F.; Klapiszewski, F.; Szwarc-Rzepka, K.; Jesionowski, T. A novel method of combination of Kraft lignin with synthetic mineral support. *Adv. Powder Technol.* **2014**, *25*, 695–703. [[CrossRef](#)]
25. Pilarska, A.A.; Wolna-Maruwka, A.; Pilarski, K. Kraft lignin grafted with polyvinylpyrrolidone as a novel microbial carrier in biogas production. *Energies* **2018**, *11*, 3246. [[CrossRef](#)]
26. Pilarska, A.A.; Pilarski, K.; Wolna-Maruwka, A. Cell immobilization on lignin–polyvinylpyrrolidone material used for anaerobic digestion of waste wafers and sewage sludge. *Environ. Eng. Sci.* **2019**, *36*, 478–490. [[CrossRef](#)]
27. Klapiszewski, Ł.; Bartczak, P.; Wysokowski, M.; Jankowska, M.; Kabat, K.; Jesionowski, T. Silica conjugated with kraft lignin and its use as a novel “green” sorbent for hazardous metal ions removal. *Chem. Eng. J.* **2015**, *260*, 684–693. [[CrossRef](#)]
28. Li, Z.; Xiao, D.; Ge, Y.; Koehler, S. Surface-functionalized porous lignin for fast and efficient lead removal from aqueous solution. *ACS Appl. Mater. Inter.* **2015**, *7*, 15000–15009. [[CrossRef](#)]
29. Singleton, P.; Keyser, H.; Sand, E. *Development and evaluation of liquid inoculants. Inoculants and Nitrogen Fixation of Legumes in Vietnam*; Herridge, D., Ed.; ACIAR Proceedings 109e; Australian Centre for International Agricultural Research: Canberra, Australia, 2002; pp. 52–66.
30. Norm VDI 4630. *Fermentation of Organic Materials Characterization of the Substrate, Sampling, Collection of Material Data, Fermentation Tests*; German Engineers Club: Düsseldorf, Germany, 2006.
31. Pilarska, A.A.; Pilarski, K.; Ryniecki, A.; Tomaszuk, K.; Dach, J.; Wolna-Maruwka, A. Utilization of vegetable dumplings waste from industrial production by anaerobic digestion. *Int. Agrophys.* **2017**, *31*, 93–102. [[CrossRef](#)]
32. Montalvo, S.; Díaz, F.; Guerrero, L.; Sánchez, E.; Borja, R. Effect of particle size and doses of zeolite addition on anaerobic digestion processes of synthetic and piggy wastes. *Process. Biochem.* **2005**, *40*, 1475–1481. [[CrossRef](#)]
33. Ivanova, G.; Rákhely, G.; Kovács, K.L. Hydrogen production from biopolymers by *Caldicellulosiruptor saccharolyticus* and stabilization of the system by immobilization. *Int. J. Hydrog. Energy* **2008**, *33*, 6953–6961. [[CrossRef](#)]

34. Pilarski, K.; Pilarska, A.A.; Witaszek, K.; Dworecki, Z.; Żelaziński, T.; Ekielski, A.; Makowska, A.; Michniewicz, J. The impact of extrusion on the biogas and biomethane yield of plant substrates. *J. Ecol. Eng.* **2016**, *17*, 264–272. [[CrossRef](#)]
35. DIN Guideline 38 414-S8. *Characterisation of the Substrate, Sampling, Collection of Material Data, Fermentation Tests*; German Institute for Standardization: Berlin, Germany, 1985.
36. Wolna-Maruwka, A.; Piechota, T.; Niewiadomska, A.; Dach, J.; Szczech, M.; Jędrzycka, M.; Pilarska, A.A. An assessment of adaptive and antagonistic properties of *Trichoderma* sp. strains in vegetable waste composts. *Arch. Environ. Prot.* **2017**, *43*, 2–81. [[CrossRef](#)]
37. Amann, R.I.; Krumholz, L.; Stahl, D.A. Fluorescent-oligonucleotide probing of whole cells for determinative, phylogenetic, and environmental studies in microbiology. *J. Bacteriol.* **1990**, *172*, 762–770. [[CrossRef](#)] [[PubMed](#)]
38. Amann, R.I.; Binder, B.J.; Olson, R.J.; Chisholm, S.W.; Devereux, R.; Stahl, D.A. Combination of 16S rRNA targeted oligonucleotide probes with flow cytometry for analyzing mixed microbial populations. *Appl. Environ. Microbiol.* **1990**, *56*, 1919–1925. [[PubMed](#)]
39. Stahl, D.A.; Amann, R. Development and application of nucleic acid probes. In *Nucleic Acid Techniques in Bacterial Systematics*; Stackebrandt, E., Goodfellow, M., Eds.; Wiley: New York, NY, USA, 1991; pp. 205–248.
40. Camiña, F.; Trasar-Cepeda, C.; Gil-Sotres, F.; Leirós, C. Measurement of dehydrogenase activity in acid soils rich in organic matter. *Soil Biol. Biochem.* **1998**, *30*, 1005–1011. [[CrossRef](#)]
41. Wolna-Maruwka, A.; Niewiadomska, A.; Piechota, T.; Karwatka, K.; Pilarska, A.A. The handling of composted onion waste in the form of substrates for the proliferation of the *Trichoderma* sp. *Ann. Set Environ. Prot.* **2019**, *21*. In Press.
42. Chen, Y.; Cheng, J.J.; Creamer, K.S. Inhibition of anaerobic digestion process: A review. *Bioresour. Technol.* **2008**, *99*, 4044–4064. [[CrossRef](#)]
43. Pilarska, A.A.; Pilarski, K.; Waliszewska, B.; Zborowska, M.; Witaszek, K.; Waliszewska, H.; Kolasiński, M.; Szwarz-Rzepka, K. Evaluation of bio-methane yields for high-energy organic waste and sewage sludge: A pilot-scale study for a wastewater treatment plant. *Environ. Eng. Manag. J.* **2019**, *18*, 2019–2030.
44. Li, X.; Li, M.; Pu, Y.; Ragauskas, A.J.; Klett, A.S.; Thies, M.; Zheng, Y. Inhibitory effects of lignin on enzymatic hydrolysis: The role of lignin chemistry and molecular weight. *Renew. Energ.* **2018**, *123*, 664–674. [[CrossRef](#)]
45. Kłapiszewski, L.; Rzemieniecki, T.; Krawczyk, M.; Malina, D.; Norman, M.; Zdarta, J.; Majchrzak, I.; Dobrowolska, A.; Czaczyk, K.; Jesionowski, T. Kraft lignin/silica–AgNPs as a functional material with antibacterial activity. *Colloid. Surf. B* **2015**, *134*, 220–228. [[CrossRef](#)]
46. Zhao, Y.; Tagami, A.; Dobeles, G.; Lindström, M.E.; Sevastyanova, O. The impact of lignin structural diversity on performance of cellulose nanofiber (CNF)-starch composite films. *Polymers* **2019**, *11*, 538. [[CrossRef](#)] [[PubMed](#)]
47. Kosmulski, M. Zeta potentials in nonaqueous media: How to measure and control them. *Colloids Surf. A Physicochem. Eng. Asp.* **2009**, *159*, 277–281. [[CrossRef](#)]
48. Latif, M.A.; Mehta, C.M.; Batstone, D.J. Influence of low pH on continuous anaerobic digestion of waste activated sludge. *Water Res.* **2017**, *113*, 42–49. [[CrossRef](#)] [[PubMed](#)]
49. Krakat, N.; Demirel, B.; Anjum, R.; Dietz, D. Methods of ammonia removal in anaerobic digestion: A review. *Water Sci. Technol.* **2017**, *76*, 1925–1938. [[CrossRef](#)] [[PubMed](#)]
50. Suschka, J.; Grübel, K. Nitrogen in the process of waste activated sludge anaerobic digestion. *Arch. Environ. Prot.* **2014**, *40*, 123–136. [[CrossRef](#)]
51. Snell, J.R. Anaerobic digestion: Nitrogen changes and losses during anaerobic digestion. *Sew. Work. J.* **1943**, *15*, 56–70.
52. Sheng, K.; Chen, X.; Pan, J.; Klossa, R.; Wei, Y.; Ying, Y. Effect of ammonia and nitrate on biogas production from food waste via anaerobic digestion. *Biosyst. Eng.* **2013**, *116*, 205–212. [[CrossRef](#)]
53. Yuan, H.; Zhu, N. Progress in inhibition mechanisms and process control of intermediates and by-products in sewage sludge anaerobic digestion. *Renew. Sustain. Energy Rev.* **2016**, *58*, 429–438. [[CrossRef](#)]
54. Gong, W.; Ran, Z.; Ye, F.; Zhao, G. Lignin from bamboo shoot shells as an activator and novel immobilizing support for α -amylase. *Food Chem.* **2017**, *228*, 455–462. [[CrossRef](#)]
55. Lalov, I.G.; Krysteva, M.A.; Phelouzat, J.L. Improvement of biogas production from vinasse via covalently immobilized methanogens. *Bioresour. Technol.* **2001**, *79*, 83–85. [[CrossRef](#)]

56. Tan, X.; Wang, Z.; Lu, G.; He, W.; Wei, G.; Huang, F.; Xu, X.; Shen, W. Kinetics of soil dehydrogenase in response to exogenous Cd toxicity. *J. Hazard. Material.* **2017**, *329*, 299–309. [[CrossRef](#)] [[PubMed](#)]
57. Ding, L.; Cheng, J.; Qiao, D.; Yue, L.; Li, Y.Y.; Zhou, J.; Cen, K. Investigating hydrothermal pretreatment of food waste for two-stage fermentative hydrogen and methane co-production. *Bioresour. Technol.* **2017**, *241*, 491–499. [[CrossRef](#)] [[PubMed](#)]
58. Zhang, J.; Xiao, L.; Yang, Y.C.; Wang, Z.X.; Li, G.X. Lignin binding to pancreatic lipase and its influence on enzymatic activity. *Food Chem.* **2014**, *149*, 99–106. [[CrossRef](#)] [[PubMed](#)]
59. Park, S.; Kim, S.H.; Kim, J.H.; Yu, H.; Kim, H.J. Application of cellulose/lignin hydrogel beads as novel supports for immobilizing lipase. *J. Mol. Catal. B Enzym.* **2015**, *119*, 33–39. [[CrossRef](#)]



© 2019 by the authors. Licensee MDPI, Basel, Switzerland. This article is an open access article distributed under the terms and conditions of the Creative Commons Attribution (CC BY) license (<http://creativecommons.org/licenses/by/4.0/>).