

Received 24 July 2016; revised 4 October 2016; accepted 9 October 2016. Date of publication 4 December 2017;
date of current version 18 December 2017.

Digital Object Identifier 10.1109/JTEHM.2017.2723465

Electromechanically Actuated Multifunctional Wireless Auxetic Device for Wound Management

MARIAM MIR¹, UMAR ANSARI¹, MURTAZA NAJABAT ALI¹,
MUHAMMAD HASSAN UL IFTIKHAR¹, AND FAISAL QAYYUM²

¹Biomedical Engineering and Sciences Department, School of Mechanical and Manufacturing Engineering,
National University of Sciences and Technology, Islamabad 44000, Pakistan

²Mechanical Engineering Department, University of Engineering and Technology, Taxilla 44000, Pakistan

CORRESPONDING AUTHOR: M. N. ALI (murtaza_bme@hotmail.com)

ABSTRACT The design and fabrication of a wound healing device for chronic wounds, with multiple functions for controlled drug delivery and exudate removal, has been described in this paper. The structural features have been machined and modified through laser cutting in a biocompatible polymer cast. Miniaturized versions of electronically actuated (lead-screw and pulley) mechanisms are used for the specific purpose of controlled drug delivery. These mechanisms have been studied and tested, being controlled through a microcontroller setup. An auxetic polymeric barrier membrane has been used for restricting the drug quantities administered. Drug delivery mechanisms are powered wirelessly, through an external, active RF component; this communicates with a passive component that is buried inside the wound healing device. The exudate removal efficiency of the device has been assessed through several simple tests using simulated wound exudate. It has been found that reasonably precise quantities of drug dosages to be administered to the wound site can be controlled through both drug delivery mechanisms; however, the lead-screw mechanism provides a better control of auxetic barrier membrane actuation and hence controlled drug delivery. We propose that this device can have potential clinical significance in controlled drug delivery and exudate removal in the management of chronic wounds.

INDEX TERMS Auxetic film, chronic wounds, controlled drug delivery, exudate removal, smart medical device.

I. INTRODUCTION

The excessive infiltration of macrophages during the later inflammatory stages in wound healing, has to be is cordoned off; otherwise aninflammatory host response may lead to a chronic wound disposition [1]–[4].

In topical medications used for this purpose, therapeutics (through ointments or gels), can be difficult to maintain during normal movement. Although medicated patches are available [6], [7], pain and frequent dressing changes are still an unaddressed problem. Medicated dressings that offer predictable and controlled drug release profiles would obviate these issues [8], [9]; polyurethanes with a good cellular response might also be one solution [10], these have also been known to maintain moisture in wounds and curtail microbial bio-film formation [11], [12].

In porous auxetic biomaterials with a negative Poisson's ratio (that is they undergo an increase in cross section in

directions that are parallel and perpendicular to the direction of the applied force) [13], there will be an increase in the pore size in response to uni-axial application of force. Auxetic materials have been used in applications such as molecular sieves and size tunable filters or foams [18], [19]; where a particle is entrapped in an unexpanded structure and then freed when the pore size is increased and there is an overall expansion of the film; in response to uni-axial application of force [14]. This property of auxetic structures has the potential to be harnessed as an application for controlled drug delivery in smart bandages [15], where the precise regulation of release of a drug from the main reservoir, is a requirement.

With most preparations there is only an abstract regulation of the change in porosity (and hence the amount of drug released). Drug release cannot be 'switched off' when needed; and thus the dose regimen cannot be strictly controlled.

To our knowledge, auxetic structures have not yet been applied to functional medical devices for controlled drug delivery in wound healing. Such structures can restrict the passage of particulate matter (in case of two-dimensional membranes); when subjected to mechanical or magnetic forces, the particulate matter can be released or its flow can be stopped at will. Herein, we present a novel design for such a medical device; this device incorporates an auxetic component that is actuated by electronic means to help strictly regulate the amount of medicament that reaches the site of the wound (Figure 1 a and b).

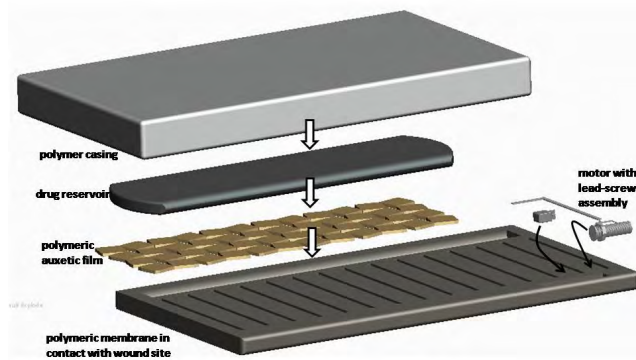

a)

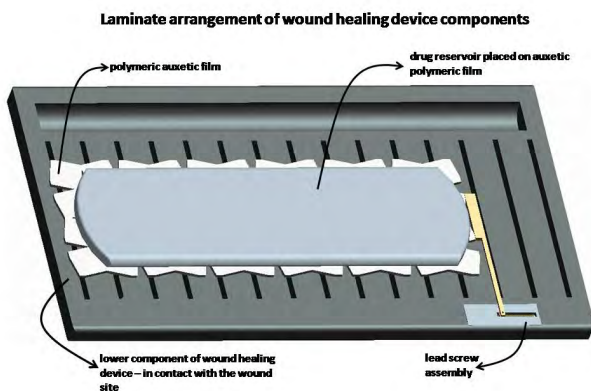

b)

FIGURE 1. a) Laminate arrangement of all components within the device, b) Skin surface component with auxetic film (placed beneath the drug reservoir).

Wearable and electrically operated medical devices offer great potential for the use of Radio Frequency (RF) remote power transmission; this way bulky battery packs can be avoided.

In the past such systems have been used to influence cardiac output [21]; pacemakers and other long term implants [22], [23]. Integration of an RF component with our wound healing device would thus obviate the need for bulky battery packs that may require replacement. Wireless power transmission has thus been harnessed in the current design;

this is the mode through which the drug delivery mechanisms are powered up.

This wound healing device also caters to the aspect of exudate removal from chronic wounds; with regards to holistic wound management; this obviates the need for frequent hospital visits or painful dressing changes.

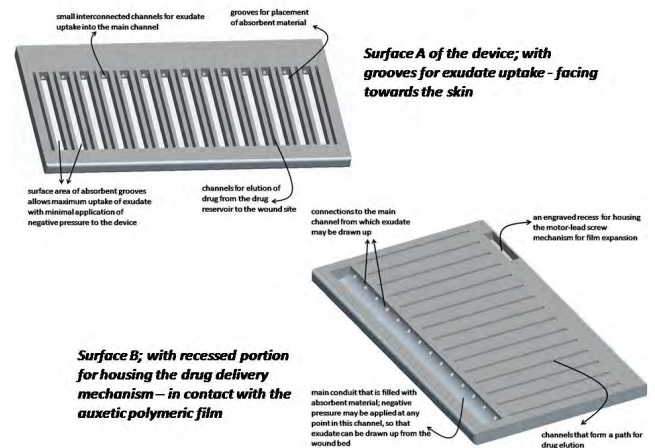

FIGURE 2. CAD model; figure showing several key features in surface A (skin contacting surface) and in surface B (in contact with the auxetic film).

II. METHODOLOGY

A. DESIGN OF THE DEVICE AND ITS COMPONENTS

CAD designs of all device components were modeled in Pro E wildfire version 5.0. The laminate arrangement of six individual device components work in synchrony to perform dual functions of taking up wound exudate and administering controlled doses of drug to the wound site. The skin surface component (see figure 2) has a number of recessed features that are tailored to house absorbent material and hollow slits that will allow the passage of drug. These grooves are connected by miniscule channels to a main conduit (on the posterior surface), that will also be filled with absorbent material; the hollow slits are in direct contact with an auxetic polymeric film (figure 1b) which is placed directly underneath the drug reservoir.

The PU (Polyurethane) film with an auxetic geometry acts a barrier, restricting the amount of drug passing through it. Each film is a planar structure with unit cells comprised of four connected squares rotated at an angle to each other (forming hinges between two unit cells in both vertical and horizontal directions). The diamond shaped hollow spaces between the rotated squares act as pores in the film. The entire auxetic structure comprises of a repetition of such unit cells patterned vertically and horizontally. The auxetic rotating squares design [24] of the polymeric film allows it to expand in both parallel and perpendicular directions in response to a uni-axial application of force, thereby leading to an overall increase in pore size (figure 3).

In this work, two mechanisms have been explored with reference to film actuation. The first mechanism is

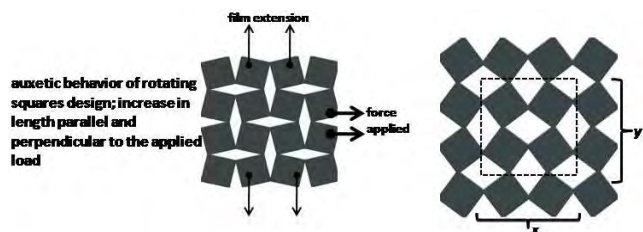

FIGURE 3. Auxetic behavior of the rotating squares design; force is applied in the y axis causes film expansion in both x and y axis.

a string-pulley mechanism which is based on the concept of a simple fixed pulley, in this case it acts across an axle (a fixture on surface B, see figure 4a). The mechanism causes transmission of force across a string that is attached at one end to the auxetic polymeric film and from the other end to the rotating shaft (motor head). When the shaft rotates in either clockwise or anticlockwise direction, the end of the string (attached to the motor shaft) gets wound circumferentially on it, thus getting tighter; the force in the taut string is transmitted horizontally through to the auxetic film, which expands in response.

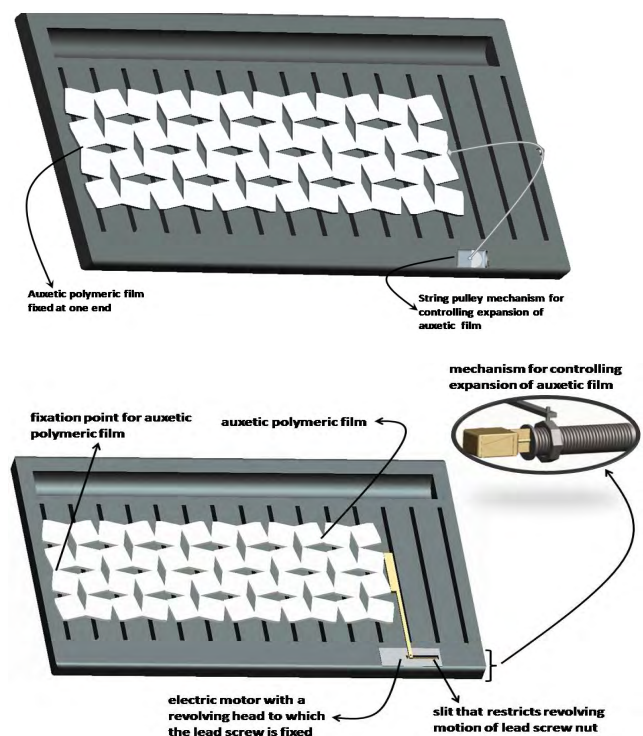

FIGURE 4. a) Schematic of the pulley mechanism attached to the auxetic film, b) CAD model of lead-screw mechanism housed in a recessed portion of surface B (magnified portion shows the attachment of motor head with lead screw).

The second mechanism employed for controlling drug delivery is the lead screw mechanism. This mechanism also modulates the amount of drug that is eluted through the auxetic film and the polymeric skin surface component of the device to reach the wound site. The linear forward motion of the lead screw nut, which is connected to the auxetic

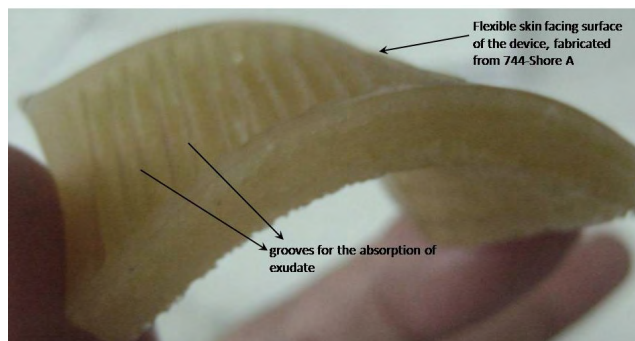

FIGURE 5. Flexible skin facing surface of the device, fabricated from Polyurethane 744, Shore A.

film through a beam attachment (see figure 4b) ultimately causes extension of the film and hence an opening of film pores. The extent of this linear motion and the degree of pore opening is controlled by rotation of the revolving motor head (shaft – refer to figure 4b) that is attached to the lead screw; the screw thus rotates in tandem with the motor head. The nut (attached to the beam) in this case is allowed only forward and backward linear motion, in response to rotation of the threaded screw. Because of controlled pore expansion, the amount of drug that elutes through the auxetic film can be controlled. The film pores can also be completely closed when drug elution is not required.

B. FABRICATION OF DEVICE COMPONENTS

Commercially available PMC-744 Parts A and B (composition - Polyurethane Prepolymer, Diethylhexyl Phthalate, Toluene Diisocyanate - mixed isomers) from Smooth-On, USA were mixed in the ratio (2A:1B), casted and cured. The PU auxetic film thickness was 0.5 mm per film.

An auxetic film CAD design (described above), was imported into the Laser/Cut-Engrave software (Shenzhen Lead CNC-LS240A); laser cutting was carried out at Power 20 W, Speed 20 mm s⁻¹. The length, thickness and width of the laser cut auxetic films were 44 mm, 0.5 mm and 22 mm respectively. Surface A/B and the device casing was cut at a Power 20W and Speed 2 mm s⁻¹; grooved features were engraved at Power 50 W, Speed 200 mm s⁻¹ and a step size of 0.05 mm. Thickness, length and width of the assembled device were (4mm, 50mm and 25mm).

C. CIRCUITRY FOR LEAD SCREW AND PULLEY MECHANISMS

Optimal operating requirements for both drug delivery mechanisms were 3 Volts and 0.17 Amperes. The lead screw mechanism was configured with bipolar transistors, to satisfy the same voltage requirements without the use of a higher battery voltage. An ATMEL AVR8-bit microcontroller was used to support device function for both mechanisms.

D. RF MODULE FOR WIRELESS POWER TRANSMISSION

The drug delivery system is powered through a wireless RF link. An 8-bit microcontroller module is used to generate

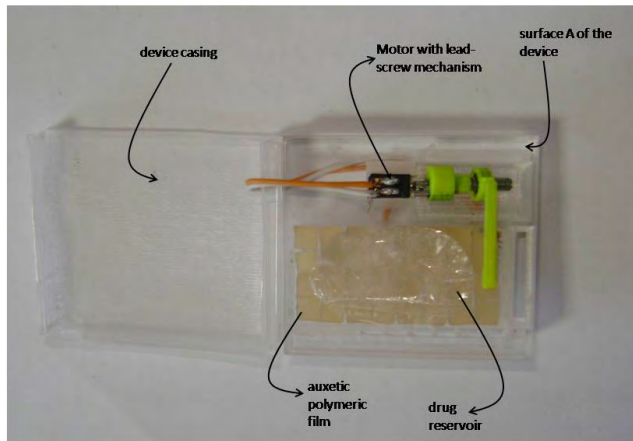

FIGURE 6. Laminate arrangement of the fabricated device with the auxetic polymeric film actuation controlling mechanism and the drug reservoir.

pulse width modulation (PWM) waves to excite the primary inductor coil for this purpose. The signal from the microcontroller is switched to the transmitter coil, using a bi-polar transistor. The received wave is rectified and filtered to obtain a smooth DC output voltage input (see figures 7 a, 8 and 9). The rectified DC voltage is fed to drive the motor (motor control movement is explained in figure 7b) that initiates auxetic film expansion and controls drug delivery, as explained previously.

E. TEST METHODS FOR VERIFICATION OF DEVICE FUNCTIONS

1) TENSILE TESTING OF AUXETIC FILM

Force-extension tests for both auxetic and non-auxetic polyurethane films were carried out. Accounting for the low modulus of the auxetic PU films, tests were carried out manually by adding small incremental weights to the lower portion of the films. Total force exerted on the samples was verified, using an electronic scale (Wei Heng, China) to which the upper end of each film was attached. Point attachment constraints have been used at extremes (at the last row of unit cells); to simulate the condition in which the film has been used in the wound healing device. It is pertinent to mention here that force versus extension tests were carried out till the point of structural deformation of the film was reached (as shown in figure 11 c); since this is the maximum force applied till which the film has been extended while drug delivery function of the device was tested.

2) DRUG DELIVERY

Tests for drug delivery and exudate removal functions were carried out. An acrylic testing frame with the same structural features as the device was developed; this had an additional provision for collection of drug that passes through the auxetic film. With each reading, the amount of drug eluted was collected at the bottom of the test bed. A pharmaceutical diluent Lactose-D-Monohydrate (Sigma Aldrich, Germany),

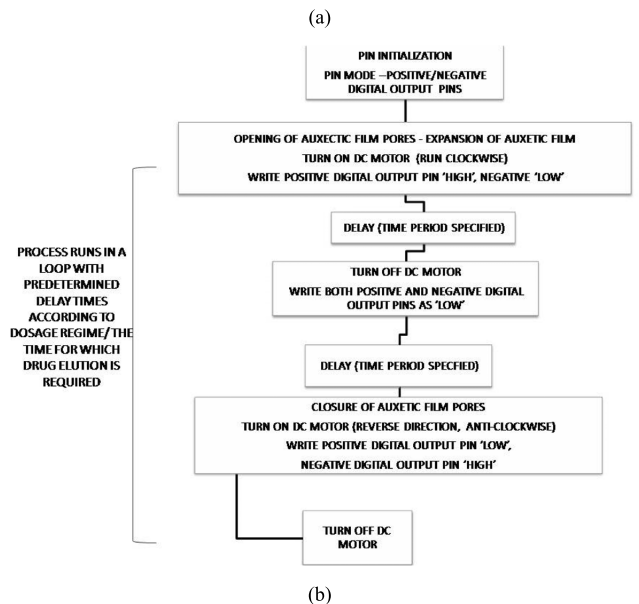
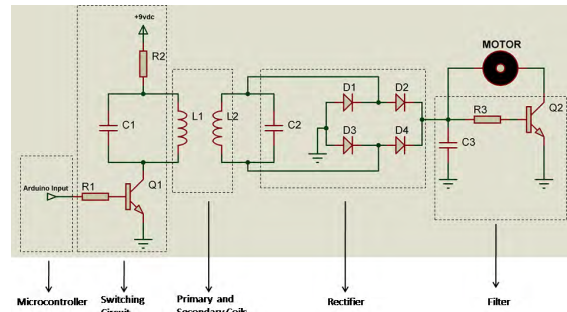

FIGURE 7. a): Circuit description - the active and passive components of the RF module used to power up the motor for controlling drug delivery mechanism. b) Flow chart showing details of the motor control through the microcontroller.

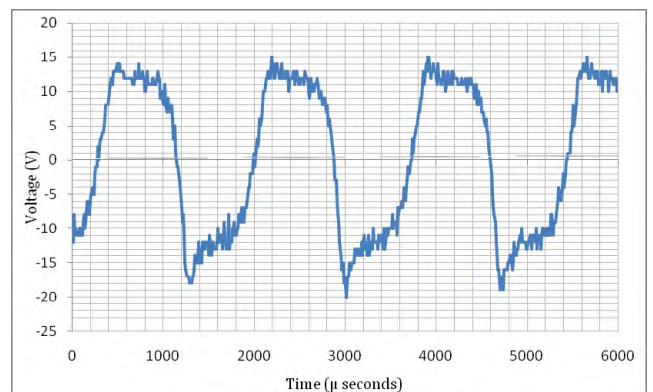

FIGURE 8. Signals obtained during power transmission through RF; the figure shows the signal obtained from the receiving unit.

was used to represent the powdered medicament. The amount of medicament was weighed using a precision balance (PS 360.R2.H, RADWAG, USA) and individual weights were recorded for each film actuation reading. Both film actuation mechanisms were supported with a microcontroller; thus

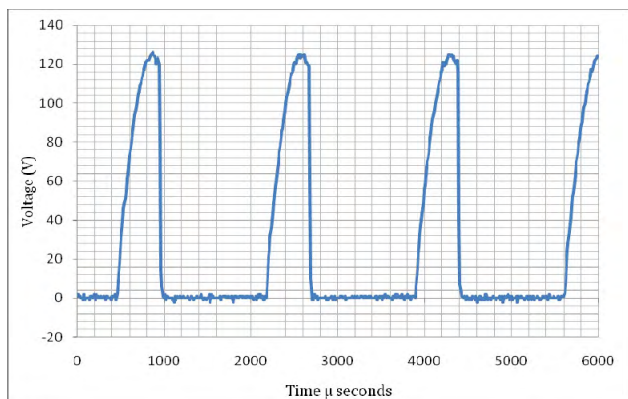

FIGURE 9. The signals obtained during power transmission through RF; the figure shows the signal obtained from the transmitting unit.

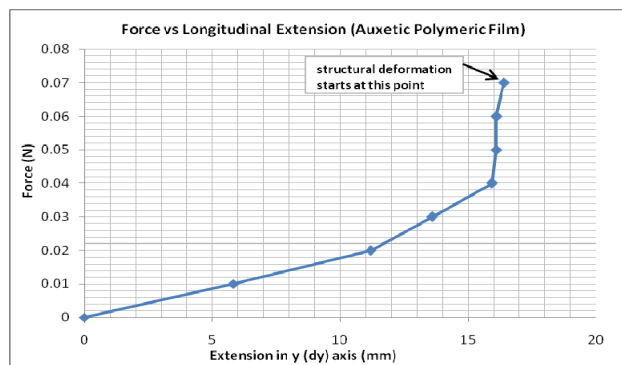

FIGURE 12. Graphical representation of the results showing longitudinal extension undergone by the auxetic polyurethane film in response to different loads.

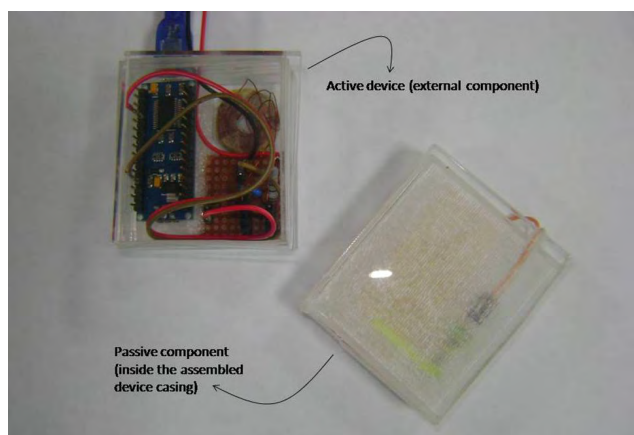

FIGURE 10. Showing the final assembled device with casing, along with the active external RF components, internal RF components are buried inside the device.

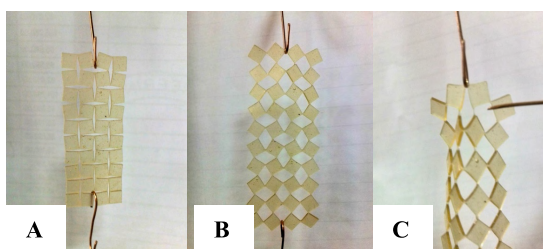

FIGURE 11. Different stages of the tensile test; A) minimal load applied, B) Unit cells and pores fully expanded, C) film undergoing structural deformation in the transverse plane at extreme load.

the motor could be powered up for specific time intervals ranging from 75 milliseconds to 300 milliseconds. This time interval directly corresponds to the number of times that the motor shaft rotates (in either clockwise or anticlockwise directions according to the polarity of the motor terminals). An increased time interval (and hence an increased number of shaft rotations) means a higher degree of film extension and greater opening of film pores. Recordings of the mass of drug eluted with each reading have been made with ten such time intervals in the range of 75 milliseconds to 300 milliseconds.

A 25 millisecond gap separates each recording. A total of ten sample readings have been recorded with respect to each time interval. Each reading has been repeated five times to determine the reliability of the quantity of drug eluted.

3) EXUDATE REMOVAL

The quantity and ease of exudate removal from the device was assessed through the use of a simulated wound exudate solution (sodium chloride/calcium chloride solution with 142 mmol sodium ions and 2.5 mmol calcium ions). Exudate removal tests were performed using cellulose fiber as the absorbent material embedded in the grooves (in surface A) and the main conduit (surface B). As stated earlier, the grooves in surface A and the conduit in surface B are connected through miniscule channels. Thus, the simulated wound exudate was allowed to be taken up by the absorbent grooves in Surface A; subsequently, the fluid was drawn up from the device through a simple 5 ml syringe (the access point for the syringe is provided in the casing of the device); this access point through to the main conduit on surface B of the device. For each new reading, the simulated wound bed was refilled with 2ml of the ionic solution (simulated exudate, composition given above). Thus active purulent wound conditions were simulated.

III. RESULTS

The auxetic polymeric films have a negative Poisson’s ratio, a property that is exploited in the proposed application; both transverse and longitudinal extensions have been recorded with increasing loads. The auxetic films have a linear response to incremental loads (figure 12 and 13) up to 0.02 N (at an extension of 11.2 mm for the longitudinal axis and 2.8 mm for the transverse axis); that is, the film undergoes elastic deformation up until this point. After 0.02 N, the polymeric film undergoes plastic deformation. The values have been plotted until the point where structural buckling of the film in the transverse plane takes place; this is the maximum load applied until which the film can be used for restricting the amount of drug delivered from the device.

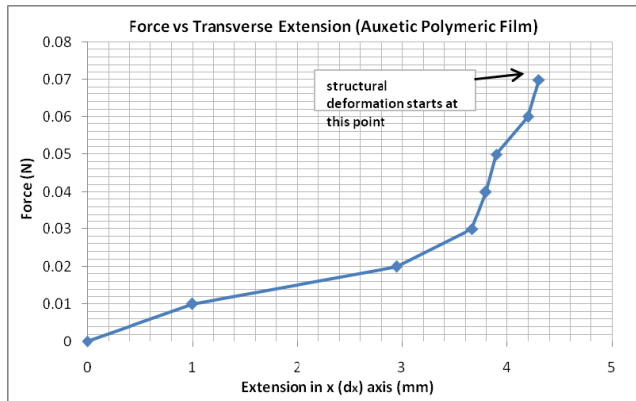

FIGURE 13. Graphical representation of tensile data for transverse extension of the film in response to different loads applied.

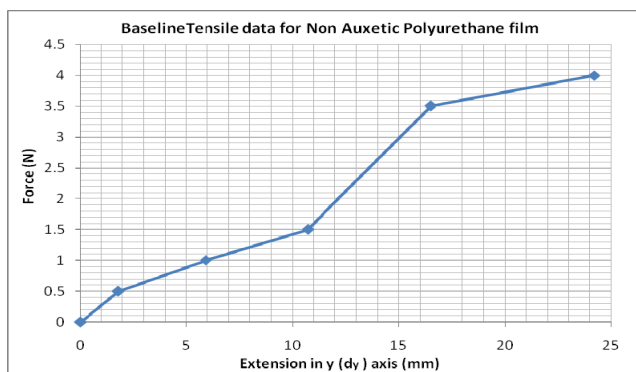

FIGURE 14. Baseline data for the control sample (polyurethane film).

TABLE 1. Quantity of drug recorded with reference to increasing times for film actuation (Pulley Mechanism).

Time delay	1st actuation 75ms	2nd actuation 100ms	3rd actuation 125ms	4th actuation 150ms	5th actuation 175ms	6th actuation 200ms	7th actuation at 225ms	8th actuation 250ms	9th actuation 275ms	10th actuation 300ms
1	1	4	7	14	14	18	23	21	22	24
2	0	2	4	12	12	18	19	20	23	25
3	0	1	8	15	24	12	14	17	21	24
4	1	4	4	13	13	17	21	21	24	21
5	1	3	1	15	12	16	25	22	21	18
Mean value (mg)	0.4	2.8	4.8	13.8	15	16.2	20.4	20.2	22.2	22.4

Break at elongation takes place at 1 N; the point at which the auxetic film breaks at the hinges. The baseline data shows similar behavior with the film undergoing both elastic and then plastic deformation; final breakage occurs at 4 N, for the non-auxetic polyurethane film.

Drug delivery tests have been carried out so that the precisely controlled, automated drug release function of the device could be validated. Recordings of the mass of drug eluted, with reference to both mechanisms have been presented in tabular form (above). The motor operation (movement of the motor for millisecond time intervals) has been pre-programmed on an Arduino interface. A mean reading was derived for each set of five readings; and interpreted

TABLE 2. Quantity of Drug recorded with reference to increasing times for film actuation (Lead-Screw Mechanism)

Time delay	1st actuation 75ms	2nd actuation 100ms	3rd actuation 125ms	4th actuation 150ms	5th actuation 175ms	6th actuation 200ms	7th actuation 225ms	8th actuation at 250ms	9th actuation 275ms	10th actuation 300ms
1	0.5	1	5	1	15	15	23	19	17	31
2	0.6	2	12	6	4	16	17	23	26	28
3	0.8	2	8	8	15	13	11	5	18	15
4	0.9	3	4	7	7	13	11	21	11	23
5	1	1	1	9	20	8	8	13	13	30
Mean Value (mg)	0.76	1.8	6	6.2	12.2	13	14	16.2	17	25.4

graphically as part of a linear trend-line. Mean values of the eluted drug amount, that correspond to increasing time intervals (from 75 ms to 300 ms) for the pulley mechanism range from 0.4 milligrams to 22.4 milligrams. Whereas mean values corresponding to increasing time intervals (from 75 ms to 300 ms) for the lead screw mechanism range from 0.76 milligrams to 25.4 milligrams (Table 2). The range of drug quantity delivered is therefore comparable for both mechanisms.

Results show that mass readings are recorded for drug eluted for both data sets, show a linearly increasing trend, with increasing time intervals for which the motor is powered up (depicted in figures 15 and 16). A comparison of individual weight recordings can be made with the sequential recordings for each mechanism's data set separately. For example, the time interval is increasing in similar increments of 25 milliseconds; corresponding to that, the increments in each weight recording correspond to a range of 0.2 mg to 4 mg, with two exceptions in each data set where the increment goes up to 9 mg (pulley mechanism) and 8 mg (lead screw mechanism).

The scatter patterns for both kinds of data may be seen in the graphs (figures 15a and 16a) Graphical representations of drug release patterns show that a strong positive, linear correlation exists between the amount of drug released and the time interval for which the motor is powered up. The flux (pharmaceutical powder released per unit time), is comparable for both mechanisms; that is, 0.104 mg ms^{-1} for the pulley mechanism and 0.097 mg ms^{-1} for the lead screw mechanism. There is thus a nominal difference between the rates of release for both mechanisms. However, in a scatter pattern comparison between both graphs, a higher regression coefficient (R^2 value) is observed for the lead screw mechanism (0.945) as compared to the pulley mechanism (0.914). A difference of 0.03 in the regression coefficients between the medicament profiles of both data sets shows that there is a higher linear correlation between the data set related to the lead screw mechanism and more variance can be accounted for by this regression model. The data distribution plots (figures 15 a and b), show the data spreads for each data set at various time intervals. It is interesting to note that it is possible to deliver larger drug quantities through the lead-screw mechanism, as compared to the pulley mechanism (see the differences between the highest non-outlier values

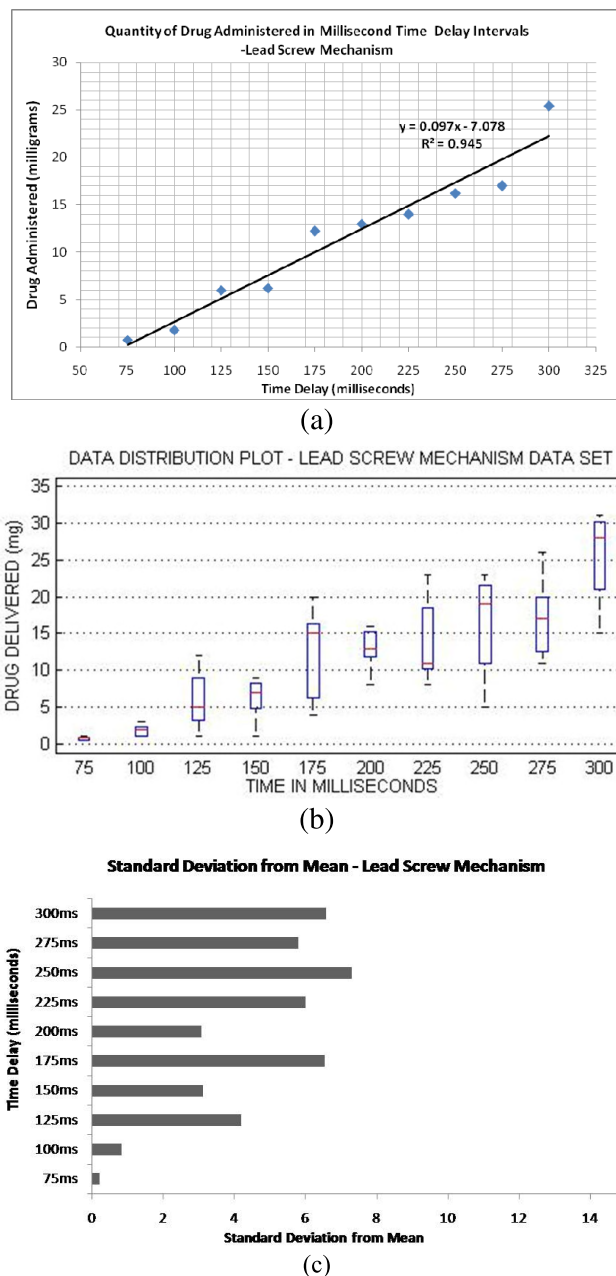
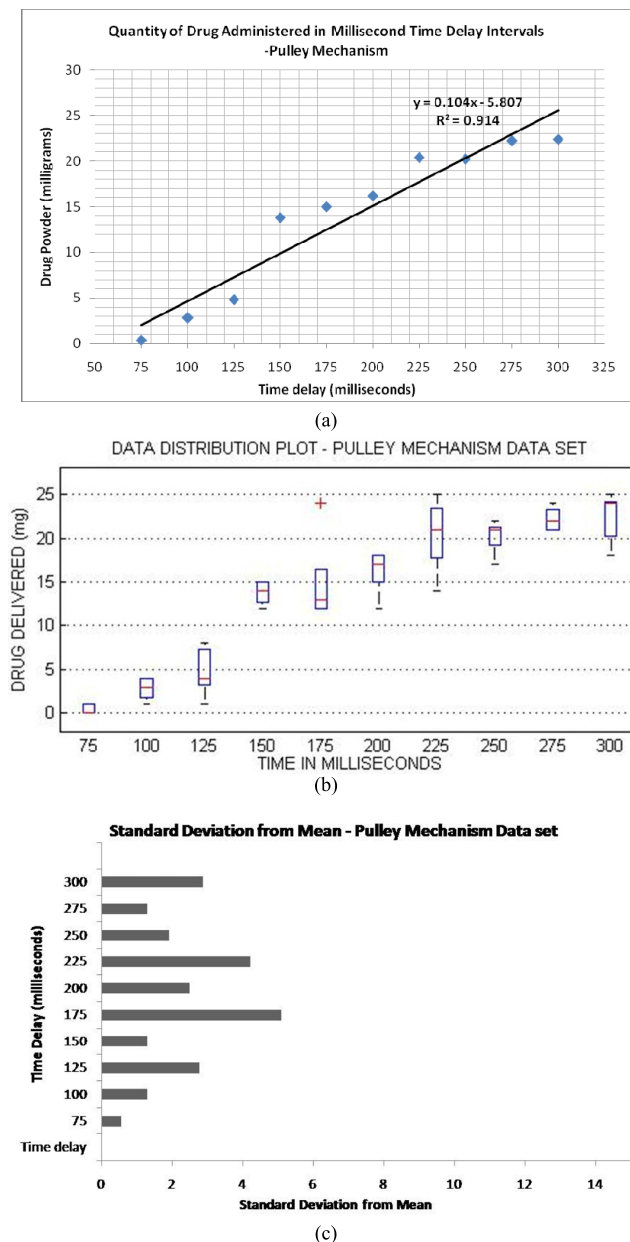

FIGURE 15. a): Graphical representation of results; showing the amounts of drug delivered through the string-pulley mechanism. b) Box plot showing the data distribution for amount of drug administered (pulley mechanism data set) relative to each time interval for which the system was powered up. c) Standard deviation from the mean, for drug amounts delivered through the pulley mechanism.

FIGURE 16. a) : Graphical representation of results; film actuation controlled through the lead-screw mechanism. b) Boxplot showing data distribution (lead screw mechanism data set) for amount of drug administered relative to each time interval for which the system was powered. c) Standard deviation from the mean , for drug amounts delivered through the lead screw mechanism.

for the 300 ms time intervals in both graphs). This may be correlated with the elastic nature of the auxetic film which exerts a counter-pull (the effect is more marked in case of the pulley mechanism), and thus limits the amount of drug delivered for longer times of motor actuation.

In the first series of tests, only 0.8 ml exudate was drawn up from the device. The amount increased in subsequent readings, (a maximum of 2ml) in last set of readings. Fresh SE solution was added to the simulated wound bed after specific time intervals; absorbent cellulose material was allowed to

soak up a maximum amount for 15 minutes after which it was drawn up from the absorbent conduit on surface B. The graph (figure 17), shows cumulative readings of the exudate absorbed by the device, against exudate amount drawn up from the device.

IV. DISCUSSION

This study aims to investigate the functioning of a wound healing device with multiple functionalities of controlled drug delivery and exudate removal. A flexible biocompatible

TABLE 3. Comparison of the rate of release (flux or slope of the graph) and regression coefficient values for both data sets.

Mode of Drug Delivery	Rate of Release (mg/ms)	Regression Coefficient for Linear Data (R ² value)
Pulley Mechanism	0.104	0.914
Lead-Screw Mechanism	0.097	0.945

TABLE 4. Quantity of Simulated Exudate (SE), taken up from the simulated wound site; four data sets were obtained; the values have been averaged.

SE added for each reading	SE added (cumulative)	Quantity of SE removal (1)	Quantity of SE removal (2)	Quantity of SE removal (3)	Quantity of SE removal (4)	Quantity of SE removal (average)	Quantity of SE removal (Cumulative)
2ml	2	0.8	1.8	1.2	0.8	1.15	1.15
2ml	4	1.7	1.9	1.8	2	1.85	3
2ml	6	1.8	1.9	1.9	1.9	1.875	4.875
2ml	8	1.8	1.8	1.8	1.85	1.813	6.688
2ml	10	1.8	1.75	1.9	1.95	1.85	8.518

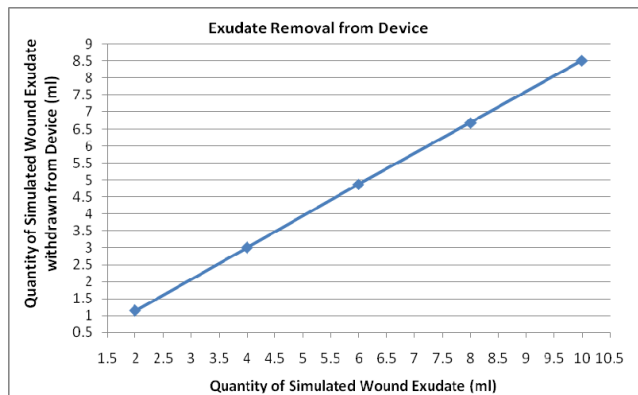

FIGURE 17. Graphical representation of the quantity of simulated wound exudate drawn up from the device as compared to the quantity of simulated wound exudate present.

polymer has been used for fabrication, so that the device can complement contours of the skin surface. Electronically controlled drug delivery mechanisms have been tested, that cater to the possibility of predicted amounts of drug elution that can be controlled at will. Both mechanisms, coupled with the auxetic rate controlling membrane, are miniaturized versions that fit compactly into the overall assembly of the device.

A larger time interval for mechanism activation means a larger number of revolutions of the motor shaft head and greater degree of film extension. Since the rate controlling polymeric film is auxetic, application of uni-axial force at the

ends of the film causes both vertical and horizontal expansion of the auxetic design, which causes an overall increase in pore size. This increase allows medicament or particulate matter to pass through the film.

Tensile tests conducted to ascertain the suitability of the soft and flexible (0.5mm thick) polyurethane barrier membrane confirm the low modulus of the film, which is a basic requirement in this application. The values are consistent with those reported in literature [26]. A reasonable amount of extension can thus be obtained with such a film, even by the use of miniaturized pulling mechanisms that can fit into the device structure without hindering overall flexibility. The auxetic nature of the films has been proved by tensile tests, since expansion is seen in both transverse and longitudinal directions. This is a much needed feature, since pore opening in response to small but controlled amount of uni-axial force, is what controls the quantity of drug elution. The difference in force values between the non auxetic and auxetic film samples is attributed to the obvious reason of material removal from the film to obtain the auxetic geometrical pattern, this is also consistent with the data reported in previous studies [27]. Tensile tests thus prove the suitability of both the polymeric material and the geometry for this particular application.

The flux or rate of release for both the drug delivery mechanisms (pulley and the lead screw) show a strong positive, linear correlation with the time intervals (for which the motor was powered up). This linearity is an advantage in such a device, since the purpose of electronic actuation for drug delivery is to decrease reliance on abstract mechanisms of drug release such as diffusion or chemical interactions. The linear behavior of the drug release profile means that the release can be predicted, or controlled in precisely timed, pre-programmed intervals. With the exception of a few outliers, (readings at 175 ms), it may be seen that the amount of powdered medicament that passes through the auxetic film is comparable for both mechanisms.

The main factor affecting the actuation of the film in the pulley mechanism is the winding of the string on the motor shaft, however, for the lead screw mechanism, the number of threads per turn on the threaded screw also have a direct affect how far the nut (and hence the beam to which the film is attached) moves, with each rotation of the motor head. Hence pore widening in the auxetic film is directly correlated with this factor as well.

Comparing both data sets, a larger amount of particulates pass through the film in the instances where the lead screw is actuated for greater length time intervals (300 ms). This shows that there is an inherent limitation in the pulley mechanism. After the motor head shaft rotates to wind the string and the string is pulled taut, this tension creates a force that is translated as extension for the auxetic film. However, the tension in the taut string also has the effect of creating an opposing force on the motor shaft, which stops it from rotating further. This effect (which we may call the elastic re-bound effect) has trickled down into several readings in the string-pulley mechanism data set. For instance, in several

readings, the opposing tension in the string (caused by the pull of the elastic film) limited the motor shaft from winding the string any further, so that there is only a small difference between the last two readings (22.2 mg for 275 ms interval and 22.4 mg for 300 ms interval). However, in the lead screw mechanism, no such limitation exists. Hence the last weight recording has gone up to 25.4 mg for 300 ms in this data set.

The flux/rate of release of both the pulley mechanism data set (0.104 mg ms^{-1}), and the lead screw mechanism data set (0.097 mg ms^{-1}) is comparable, with only a nominal difference of 0.007. This is because both mechanisms essentially achieve the same result, that is, an actuation of the film causing an overall extension and widening of the pores that leads to drug particulates passing through.

An analysis reveals that there is a difference in the degree and pattern of scatter points in our graphical interpretation for both (pulley and lead-screw) data sets. The R^2 value (refer to figures 15 and 16), which depicts the goodness of a fit typically when dealing with linear correlations such as this one, is 0.914 for the pulley mechanism data set, and 0.945 for the lead screw data set. Both values are close to 1, which shows that there is a strong linear correlation between the data. This also shows that a large degree of variance is accounted for by these regression models. These values place our initial observations of predictability of the linear data into perspective. However, the value of the regression coefficient is higher for the lead screw data set (0.945) as compared to the string-pulley data set (0.914). On this basis it may be deduced that the lead screw mechanism for drug delivery is a better suited candidate for such a device, where predictability and control of the dose administered are key considerations.

The lead screw mechanism (supported by the pre-programmed microcontroller), also enables complete closure of the film pores after the drug has been delivered; thus drug administration may be stopped completely as well, whenever this is a requirement of the treatment regime.

The main advantage of electronically controlled drug delivery lies in the complete control over the treatment regimen. Research has been conducted on other preparations [17] where drug release profiles are dependent upon the fabrication technique or chemical linkages with other agents. While offering obvious advantages for wound healing, the fact remains that there is no absolute control over the amount of drug eluting from the formulation/dressing. In the current work, we have used a pharmaceutical diluent to validate the drug release profiles; the amount of the active ingredient administered can thus be varied by varying the composition (percentage) of the active ingredient in the pharmaceutical powder (drug reservoir). The quantity of drug to be administered can be increased, decreased or stopped at will, depending on the requirement of the patient.

An ionic solution (simulated wound exudate) has been used for wound exudate removal tests. It was found that in the first of these series of tests, 0.8 ml of the simulated exudate was drawn up from the device, although 2 ml of the solution was poured into the Petri dish. This could be because initially,

the cellulose absorbent material in the grooves (surface A) of the device is completely dry and some of the solution remains entrapped in the cellulose fibers. Larger solution amounts are drawn up in later readings, in the fourth set of readings this goes up to 2 ml. Initial exudate draws were less efficient as compared to latter ones. This could be explained simply by fluid affinity that increases in wet cellulose fibers; because of the cohesive nature of water molecules. The higher absorbent capacity of this device (compared to conventional dressings) [25] is because of the larger surface area of the grooves, in which the absorbent material is stored. This additional feature of exudate collection from the device also means that the exudate can be examined clinically and drug therapy or dosage regimen can be modified accordingly.

V. CONCLUSION

This study explores the use of two wirelessly powered, electronically actuated mechanisms for precisely timed, pre-programmed drug delivery regimens. The lead-screw mechanism shows a stronger linear correlation of drug amount eluted with time. This device has the potential to allow an optimal amount of exudate to be removed; without removal of the device from the site of application. We propose that in future works, an in-vitro biological study may be conducted and the device may be modified according to the results, so that this study can be explored further with reference to clinical applications in chronic wound healing.

REFERENCES

- [1] S. Guo and L. A. DiPietro, "Factors affecting wound healing," *J. Dental Res.*, vol. 89, no. 3, pp. 219–229, Mar. 2010.
- [2] C. T. Hess, "Practice points checklist for factors affecting wound healing," *Adv. Skin Wound Care*, vol. 24, no. 4, p. 192, 2008.
- [3] T. J. Koh and L. A. DiPietro, "Inflammation and wound healing: The role of the macrophage," *Expert Rev. Molecular Med.*, vol. 13, p. e23, Jul. 2011.
- [4] A. Sindrilariu *et al.*, "An unrestrained proinflammatory M1 macrophage population induced by iron impairs wound healing in humans and mice," *J. Clin. Invest.*, vol. 121, no. 3, pp. 985–997, Mar. 2011.
- [5] B. A. Lipsky and C. Hoey, "Topical antimicrobial therapy for treating chronic wounds," *Clin. Infectious Diseases*, vol. 49, no. 10, pp. 1541–1549, 2009.
- [6] A. J. Whittam *et al.*, "Challenges and opportunities in drug delivery for wound healing," *Adv. Wound Care*, vol. 5, no. 2, pp. 79–88, Jan. 2016.
- [7] R. Sriprya, M. S. Kumar, M. R. Ahmed, and P. K. Sehgal, "Collagen bilayer dressing with ciprofloxacin, an effective system for infected wound healing," *J. Biomater. Sci. Polym. Ed.*, vol. 18, no. 3, pp. 335–351, 2007.
- [8] P. J. Tarcha, *Polymers in Controlled Drug Delivery*. New York, NY, USA: Taylor & Francis, Nov. 1990, pp. 1–296.
- [9] R. Langer, "Invited review polymeric delivery systems for controlled drug release," *Chem. Eng. Commun.*, vol. 6, nos. 1–3, pp. 1–48, 1980.
- [10] G. D. Mogosanu and A. M. Grumezescu, "Natural and synthetic polymers for wounds and burns dressing," *Int. J. Pharmaceutics*, vol. 25, no. 2, pp. 127–136, Mar. 2014.
- [11] F. Brandl, F. Kastner, R. M. Gschwind, T. Blunk, J. Teßmar, and A. Göferich, "Hydrogel-based drug delivery systems: Comparison of drug diffusivity and release kinetics," *J. Controlled Release*, vol. 142, no. 2, pp. 221–228, Mar. 2010.
- [12] J. S. Boateng, K. H. Matthews, H. N. E. Stevens, and G. M. Eccleston, "Wound healing dressings and drug delivery systems: A review," *J. Pharmaceutical Sci.*, vol. 97, no. 8, pp. 2892–2923, Aug. 2008.
- [13] B. D. Caddock and K. E. Evans, "Microporous materials with negative Poisson's ratios. I. Microstructure and mechanical properties," *J. Phys. D, Appl. Phys.*, vol. 22, no. 12, pp. 1877–1882, 1989.

- [14] A. Alderson, P. J. Davies, M. R. Williams, K. E. Evans, K. L. Alderson, and J. N. Grima, "Modelling of the mechanical and mass transport properties of auxetic molecular sieves: An idealised organic (polymeric honeycomb) host-guest system," *Mol. Simul.*, vol. 31, no. 13, pp. 897–905, Nov. 2005.
- [15] A. Alderson and K. Alderson, "Expanding materials and applications: Exploiting auxetic textiles," *Tech. Textiles Int.*, vol. 14, no. 6, pp. 29–34, Sep. 2005.
- [16] C. D. Tran and T. M. Mututuvuri, "Cellulose, chitosan, and keratin composite materials. Controlled drug release," *Langmuir*, vol. 31, no. 4, pp. 1516–1526, 2014.
- [17] R. A. Thakur, C. A. Florek, J. Kohn, and B. B. Michniak, "Electrospun nanofibrous polymeric scaffold with targeted drug release profiles for potential application as wound dressing," *Int. J. Pharm.*, vol. 364, no. 1, pp. 87–93, Nov. 2008.
- [18] A. Alderson, J. Rasburn, S. Ameer-Beg, P. G. Mullarkey, W. Perrie, and K. E. Evans, "An auxetic filter: A tuneable filter displaying enhanced size selectivity or defouling properties," *Ind. Eng. Chem. Res.*, vol. 39, no. 3, pp. 654–665, 2000.
- [19] A. Alderson, J. Rasburn, and K. E. Evans, "Mass transport properties of auxetic (negative Poisson's ratio) foams," *Phys. Status Solidi*, vol. 244, no. 3, pp. 817–827, Mar. 2007.
- [20] F. Zhang, X. Liu, S. A. Hackworth, R. J. Scلابassi, and M. Sun, "In vitro and in vivo studies on wireless powering of medical sensors and implantable devices," in *Proc. IEEE/NIH Life Sci. Syst. Appl. Workshop*, Apr. 2009, pp. 84–87.
- [21] W. W. L. Glenn, A. Mauro, E. Longo, P. H. Lavietes, and F. J. Mackay, "Remote stimulation of the heart by radiofrequency transmission—Clinical application to a patient with Stokes-Adams syndrome," *New England J. Med.*, vol. 261, pp. 948–951, Nov. 1959.
- [22] L. Eisenberg, A. Mauro, and W. W. L. Glenn, "Transistorized pacemaker for remote stimulation of the heart by radio-frequency transmission," *IRE Trans. Bio-Med. Electron.*, vol. 8, no. 4, pp. 253–257, Oct. 1961.
- [23] W. H. Ko, S. P. Liang, and C. D. F. Fung, "Design of radio-frequency powered coils for implant instruments," *Med. Biol. Eng. Comput.*, vol. 15, no. 6, pp. 634–640, Nov. 1997.
- [24] D. Attard, E. Manicaro, R. Gatt, and J. N. Grima, "On the properties of auxetic rotating stretching squares," *Phys. Status Solidi*, vol. 246, no. 9, pp. 2045–2054, Sep. 2009.
- [25] S. Thomas, G. Hughes, P. Fram, and A. Hallet, "An in-vitro comparison of the physical characteristics of hydrocolloids, hydrogels, foams and alginate/CMC fibrous dressings," *SMTL Rep.*, pp. 1–24, May 2005.
- [26] R. Adhikari, P. A. Gunatillake, S. J. McCarthy, and G. F. Meijs, "Low-modulus siloxane-based polyurethanes. I. Effect of the chain extender 1,3-bis(4-hydroxybutyl)1,1,3,3-tetramethyldisiloxane (BHTD) on properties and morphology," *J. Appl. Polym. Sci.*, vol. 83, no. 4, pp. 736–746, Jan. 2002.
- [27] M. N. Ali, J. J. C. Busfield, and I. U. Rehman, "Auxetic oesophageal stents: Structure and mechanical properties," *J. Mater. Sci. Mater. Med.*, vol. 25, no. 2, pp. 527–553, Feb. 2014.



UMAR ANSARI received the Ph.D. degree in biomedical engineering from the University of New South Wales, Australia. He has been teaching various courses in the Department of Biomedical Engineering, National University of Sciences and Technology, since 2013. His research interest includes implantable devices, rehabilitation engineering and functional electronics stimulation. His current research projects are rehabilitation of stroke patients and diagnostic bio sensing



MURTAZA NAJABAT ALI received the B.Sc. degree in biomedical engineering from the University of Engineering and Technology, Taxila, Pakistan, the M.Sc. degree in biomedical engineering from Brunel University, and the Ph.D. degree from The University of Sheffield. As part of his M.Sc. academic program, he completed a research project entitled Appraisal of the efficacy and effectiveness of Auxetic structures configured as endovascular implant relevant to the palliative treatment of oesophageal cancer. He is currently a Biomedical Engineer. He was a Post-Doctorate Research Assistant with the Kroto Research Institute, The University of Sheffield, for the pilot project, which has been supported by the Research and Innovation Department, The University of Sheffield.



MUHAMMAD HASSAN UL IFTIKHAR received the M.S. degree in biomedical engineering from the National University of Sciences and Technology and the University of Engineering and Technology. He is currently with Shaukat Khanum Hospital, Lahore, in biomedical engineering. He was involved in drug delivery, RF communication for drug delivery, and sensor development.



MARIAM MIR received the M.S. degree in biomedical sciences from the National University of Sciences and Technology and the University of Engineering and Technology, where she is currently pursuing the Ph.D. degree in biomedical sciences. She has a vast experience in research and her research interest includes biomedical implants and biomaterials and development of drug delivery mechanisms.



FAISAL QAYYUM received the B.S. and M.S. degrees in mechanical engineering from the University of Engineering and Technology, Taxila, Pakistan. He is currently serving as a Lecturer with the Mechanical Engineering Department, University of Engineering and Technology. His main research interests are fracture mechanics, mechanics of materials, FEA, and composites.