

Homologous recombination prevents methylation-induced toxicity in *Escherichia coli*

Anetta Nowosielska, Stephen A. Smith¹, Bevin P. Engelward¹ and M. G. Marinus*

Department of Biochemistry and Molecular Pharmacology, University of Massachusetts Medical School, 364 Plantation Street, Worcester MA 01605 USA and ¹Biological Engineering Division, Massachusetts Institute of Technology, Cambridge, MA 02139, USA

Received December 13, 2005; Revised January 4, 2006; Accepted March 27, 2006

ABSTRACT

Methylating agents such as N-methyl-N'-nitro-N-nitrosoguanidine (MNNG) and methyl methane sulfonate (MMS) produce a wide variety of N- and O-methylated bases in DNA, some of which can block replication fork progression. Homologous recombination is a mechanism by which chromosome replication can proceed despite the presence of lesions. The two major recombination pathways, RecBCD and RecFOR, which repair double-strand breaks (DSBs) and single-strand gaps respectively, are needed to protect against toxicity with the RecBCD system being more important. We find that recombination-deficient cell lines, such as *recBCD recF*, and *ruvC recG*, are as sensitive to the cytotoxic effects of MMS and MNNG as the most base excision repair (BER)-deficient (*alkA tag*) isogenic mutant strain. Recombination and BER-deficient double mutants (*alkA tag recBCD*) were more sensitive to MNNG and MMS than the single mutants suggesting that homologous recombination and BER play essential independent roles. Cells deleted for the *polA* (DNA polymerase I) or *priA* (primosome) genes are as sensitive to MMS and MNNG as *alkA tag* bacteria. Our results suggest that the mechanism of cytotoxicity by alkylating agents includes the necessity for homologous recombination to repair DSBs and single-strand gaps produced by DNA replication at blocking lesions or single-strand nicks resulting from AP-endonuclease action.

INTRODUCTION

Multiple DNA repair systems specific for alkylation damage are present in most organisms suggesting that alkylating

agents are significant contributors of endogenous and exogenous sources of DNA damage. At least 12 different nitrogen and oxygen atoms on DNA bases can be alkylated as well as oxygen atoms on the phosphates of the DNA backbone (1). The major products of alkylation include N7-methylguanine (7-meG), N3-methyladenine (3-meA) and O⁶-methylguanine (O⁶-meG) with smaller amounts of N1-methyladenine, N3-methylcytosine and O⁴-methylthymine (2). N7-methylguanine is thought to be relatively innocuous, while the O-methylated bases promote mutagenesis by miscoding (3) and N3-meA, N1-methyladenine, N3-methylcytosine are cytotoxic through their ability to block replicative polymerases (4,5). Agents such as methyl methane sulfonate (MMS) produce predominantly N-methylation while N-methyl-N'-nitro-N-nitrosoguanidine (MNNG) produces both N- and O-methylation (2). In addition to these agents, which are used for research purposes, alkylating agents are also used clinically for the treatment of a variety of cancers (6,7).

The first of three different mechanisms (Figure 1) to repair alkylated bases in *Escherichia coli* involves direct removal of methyl groups from O⁶-methylguanine and O⁴-methylthymine by the constitutive Ogt and the inducible Ada methyltransferases (1,7–9). The inducible AlkA and constitutive Tag glycosylases constitute a second mechanism to remove principally N3-meA, creating an abasic site which is a substrate for AP endonucleases, deoxyribosephosphodiesterases, DNA polymerase I and DNA ligase in a typical base excision repair (BER) fashion (10,11). The third mechanism employs the DNA-dioxygenase, AlkB, which directly regenerates unmodified bases from N1-methyladenine or N3-methylcytosine by oxidative demethylation (12,13). The Ada protein is also a positive regulator of transcription of its own gene as well as the *alkA*, *alkB* and *aidB* genes (6,14) and the three induced Ada, AlkA and AlkB activities remove 12 out of 14 possible modifications (1).

Although much has been learned about these repair mechanisms and the transcriptional regulation of the Ada response, relatively little is known about the role of homologous recombination in response to methylation damage in *E.coli*.

*To whom correspondence should be addressed. Tel: +1 508 856 3330; Fax: +1 508 856 2003; Email: martin.marinus@umassmed.edu

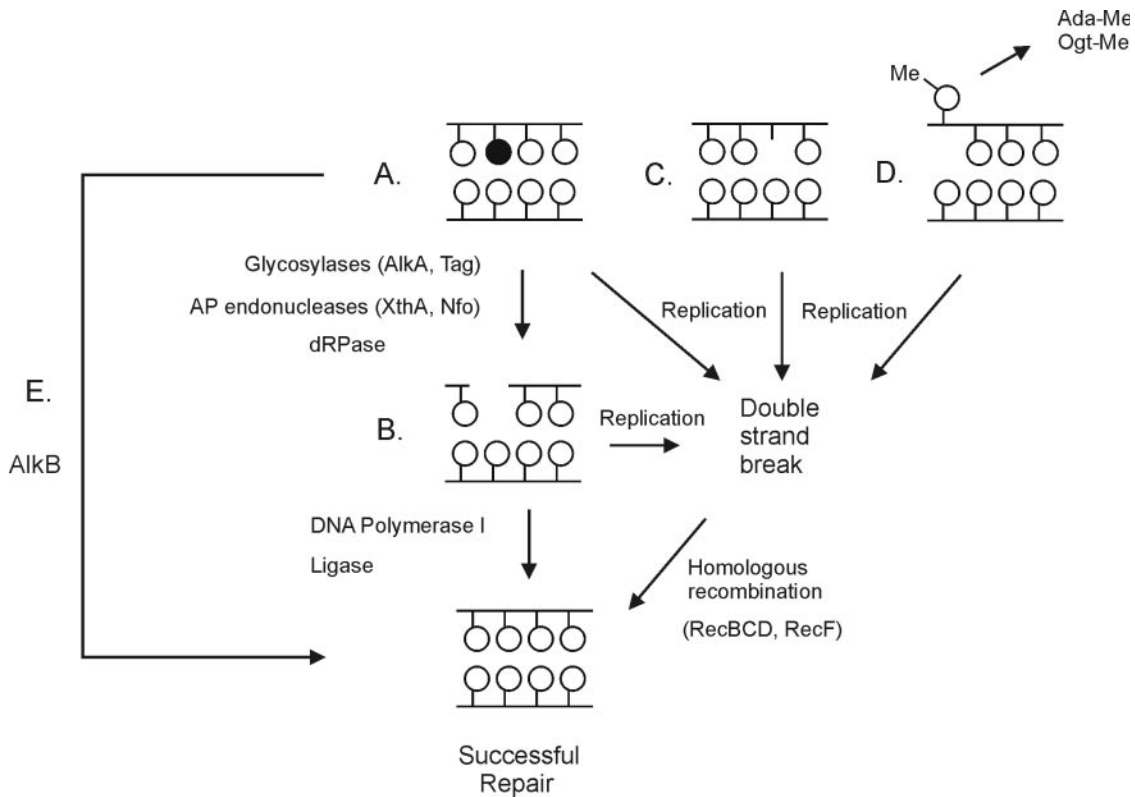

Figure 1. Methylation damage and repair pathways. (A) Replication-blocking lesions (filled circle) may provoke DSB formation by replication fork breakdown or stalling. AlkA and Tag glycosylases remove methylated bases (filled circle) and the resulting abasic site is recognized and cleaved by the AP endonucleases XthA or Nfo, followed by repair, replication and ligation to restore the integrity of DNA. Replication through the nicked substrate, (B) results in replication fork collapse and DSB formation. (C) Depurination of methylated bases results in the formation of abasic sites which are replication-blocking lesions and may lead to replication fork stalling or breakdown and DSB formation. (D) Ada and Ogt methyltransferases remove methyl groups from oxygen residues on flipped out bases. If not repaired, O-methylated bases can block replication forks to form structures acted upon by RecBCD. (E) AlkB directly removes methyl groups from N1-methyladenine and N3-methylcytosine by oxidative demethylation. DSBs are repaired by the two major homologous recombination repair pathways, RecBCD and RecF. The RecF pathway includes RecF, RecJ, RecN, RecO, RecQ and RecR. Both pathways utilize RecA, RuvA, RuvB, RuvC and RecG.

RecA is essential for homologous recombination in *E. coli*, functioning to stimulate homology searching to allow for synapsis (15). Although there are numerous reports in the literature documenting the increased sensitivity of *recA* mutants to methylating agents [e.g. (16)], these results are difficult to interpret because of the multiple roles of RecA in cell physiology including regulation of the SOS response (17) and translesion synthesis (TLS) by PolV (UmuD'₂C) (17). Unlike RecA, there are other genes that have well-defined roles in homologous recombination that are not part of SOS or TLS. For example, RecBCD and RecFOR are essential components of the two major recombinational repair pathways in *E. coli*, the former being primarily for the purpose of processing double-strand breaks (DSBs), and the latter for processing single-strand gaps (18,19). The RecF pathway also involves the RecJ exonuclease (20) and the RecQ helicase (21). After recruitment of RecA to single-stranded DNA by either RecBCD or RecFOR, RecA stimulates strand invasion of a homologous duplex (15), which can lead to strand exchange using either the RecG or RuvAB helicases to move the Holliday junctions (22). RuvC then cleaves these junctions to resolve the recombination intermediates. These recombination processes also require 'housekeeping' enzymes, such as topoisomerases, single-strand binding protein, ligase and polymerases (18).

To our knowledge, although BER and direct reversal by the Ada and AlkB systems have clearly been demonstrated to play critical roles in response to alkylation damage in *E. coli*, the relative importance of homologous recombinational repair has not been previously reported except for a single publication on the effect of *recB* and *recF* pathway mutations in AP endonuclease-deficient cells (23). Thus, in order to completely understand the role of recombination in preventing methylation damage-induced toxicity to DNA, we have constructed a comprehensive set of isogenic mutant strains and analyzed their sensitivities to MMS and MNNG.

MATERIALS AND METHODS

Strains

All strains are derivatives of *E. coli* K-12 (Table 1) and most were constructed by P1vir transduction. The *tag::Tet* strain was constructed by first cloning the *tag* gene from the chromosome by PCR into a plasmid and then inserting the tetracycline-resistance genes from mTn10 into the BamHI site of the *tag* gene. The plasmid DNA was linearized and recombined into the chromosome by selection for tetracycline-resistance as described by Murphy *et al.* (24).

Table 1. *E. coli* K-12 strains used in this study

| Strain Number | Genotype | Source of mutation/plasmid |
|---------------|--|----------------------------|
| GM4286 | $\Delta polA::Kan/ F' polA^+$ | C. Joyce |
| GM7330 | F' $\Delta(lacY-lacZ)286$ ($\phi 80dIII\Delta lacZ9$) <i>ara thi</i> (?) | E. B. Konrad |
| GM7332 | $\Delta recG263::Kan Met^-$ | R. G. Lloyd |
| GM7334 | <i>recA56 srl300::Tn10 Met^-</i> | A. J. Clark |
| GM7338 | <i>ruvC53 eda51::Tn10 $\Delta recG263::Kan Met^-$</i> | Laboratory stock |
| GM7340 | <i>ruvC53 eda51::Tn10 Met^-</i> | R. G. Lloyd |
| GM7346 | $\Delta recBCD::Kan$ | K. C. Murphy |
| GM7368 | <i>uvrA6 malE::Tn10</i> | CGSC ^a |
| GM7378 | <i>recR252::mTn10Kan</i> | R. G. Lloyd |
| GM7380 | <i>recO1504::Tn5</i> | R. G. Lloyd |
| GM7382 | <i>recJ284::Tn10</i> | R. G. Lloyd |
| GM7388 | <i>recD1901::Tn10</i> | D. P. Biek |
| GM7390 | $\Delta ruvABC::Cam$ | R. G. Lloyd |
| GM7394 | <i>lexA3 mal::Tn9</i> | D. Mount |
| GM7512 | $\Delta(ada-alkB)25::Cam$ | G. Walker |
| GM7517 | <i>sfiA211</i> | Laboratory stock |
| GM7555 | <i>sfiA211 priA2::Kan</i> | S. Sandler |
| GM7624 | <i>alkA1 zef-3129::Tn10</i> | M. Volkert |
| GM7633 | <i>alkA1 zef-3129::Tn10 $\Delta recBCD::Kan$</i> | Laboratory stock |
| GM7641 | <i>alkA1 zef-3129::Tn10 tagA1 zhb::Tn5</i> | Laboratory stock |
| GM7645 | $\Delta uvrD291::Tet$ | K. C. Murphy |
| GM7649 | $\Delta polA::Kan$ | C. Joyce |
| GM7653 | <i>recQ::Tet</i> | A. R. Poteete |
| GM7663 | <i>recN::Tet</i> | R. G. Lloyd |
| GM7693 | $\Delta recBCD::Kan recN::Tet$ | Laboratory stock |
| GM7695 | $\Delta recBCD::Kan recQ::Tet$ | Laboratory stock |
| GM7769 | <i>recF::Tet</i> | K. C. Murphy |
| GM7771 | <i>recF::Tet $\Delta recBCD::Kan$</i> | Laboratory stock |
| GM7836 | <i>recB270 (Ts)</i> | Laboratory stock |
| GM8098 | $\Delta tag::Tet$ | This work |
| GM8241 | F' 5'-Exo Cam/GM7649 | C. Joyce |
| GM8242 | F' Klenow Cam/GM7649 | C. Joyce |
| GM8397 | <i>alkA1 zef-3129::Tn10 tagA1 zhb::Tn5 $\Delta recBCD::Kan$</i> | Laboratory stock |
| GM8444 | <i>ogt::Kan</i> | (9), B. Sedgwick |
| GM8445 | <i>ada-10::Tn10 ogt::Kan</i> | Laboratory stock |
| GM8454 | <i>ada-10::Tn10 ogt::Kan $\Delta recBCD::Kan$</i> | Laboratory stock |
| GM8461 | $\Delta tag::mTn10 ada$ $\Delta(ada-alkB)25::Cam$ | Laboratory stock |
| GM8467 | $\Delta nfo-1::Kan thyA::Cam$ | B. Weiss |
| GM8468 | $\Delta nfo-1::Kan thyA::Cam xthA1 zdh201::Tn10$ | Laboratory stock |
| GM8470 | <i>xthA1 zdh-201::Tn10</i> | B. Weiss |
| GM8487 | $\Delta nfo-1::Kan xthA1 zdh201::Tn10 recB270 (Ts)$ | Laboratory stock |
| GM8488 | $\Delta nfo-1::Kan xthA1 zdh201::Tn10 recF322::Tn3$ | Laboratory stock |
| GM8609 | AS MV1601 but $\Delta recBCD::Kan$ | Laboratory stock |
| MV1161 | <i>thr-1 araC14 leuB6Δ</i> (<i>gpt-proA</i>)62 <i>lacY1 tsx-33</i> <i>supE44 galK2 hisG4 rfbD1</i> <i>mgl-51 rpoS396 rpsL31(Str^R)</i> <i>kdgK51 xylA5 mtl-1</i> <i>argE3 thi-1 rfa-550</i> | M. R. Volkert |
| MV1601 | As MV1161 but <i>alkB52::Mud1(Ap^R lac)</i> | M. R. Volkert |
| MV2127 | As MV1601 but <i>recF332::Tn3</i> | M. R. Volkert |

The GM strains above are derivatives of GM7330 [F' $\Delta(lacY-lacZ)286$ $\phi 80dIII\Delta lacZ9$ *ara thi* (?)].

^a*E. coli* Genetic Stock Center, Biology Department, Yale University, New Haven CT 06520-8193.

The insertion of the tetracycline-resistance genes into the chromosomal *tag* gene was verified by PCR.

To introduce $\Delta recBCD::Kan$ into strains which already have a kanamycin-resistance marker on chromosome, we introduced a *thyA::Cam* marker by P1vir transduction and then transduced a second time to Thy⁺ with a P1vir lysate prepared on a $\Delta recBCD::Kan$ host and tested the transductants for ultraviolet and chloramphenicol sensitivity. The *thyA::Cam* replacement allele was constructed as described (24).

Plasmid p24Tag (25), which has the *tag* gene under control of the arabinose BAD promoter, was a gift from Dr Leona Samson (MIT, Cambridge MA). Plasmid pBAR (26), which has the *ada* gene under control of an IPTG-inducible promoter, was a gift from Dr Bruce Demple (Harvard School of Public Health, Boston, MA).

Media and chemicals

L broth consists of 20 g tryptone, 10 g yeast extract, 1 g NaCl and 4 ml 1 M NaOH per liter, solidified when required with 16 g agar (Difco). Minimal medium was that described by Davis and Mingioli minimal salts without glucose (27). Ampicillin, chloramphenicol, kanamycin and tetracycline were added to media at 100, 10, 20 and 10 μ g/ml, respectively. MNNG (Sigma Aldrich) was prepared by dissolving 1 mg MNNG in 100 μ l DMSO and adding 900 μ l sterile water. Aliquots were stored frozen at -20°C . MMS (Sigma Aldrich) was added directly to cell cultures.

Cytotoxicity assays

Overnight cultures were diluted 1:100 and grown in L medium at 37°C to $OD_{600} = 0.4-0.6$. The cells were centrifuged and resuspended in the equal volume of minimal salts and treated with 6, 12 and 18 mM MMS for 15 min at 37°C . For MNNG the doses were 10, 20 and 40 μ g/ml for 10 min at 37°C . Samples were withdrawn, diluted and plated on L plates for survival. Colonies were counted and survival calculated as a percentage of the untreated control value. MMS gradient plates were prepared using a slanted 25 ml L-broth agar bottom layer containing 20 μ l MMS and a similar volume of top layer without MMS. MNNG gradient plates were prepared in the same way with 200 μ g/ml MNNG. For all experiments, a representative result is shown and each survival curve was reproduced at least twice.

RESULTS

BER increases cell survival after exposure to MMS and MNNG

Throughout this paper we have used low doses of MMS and MNNG and relatively short exposure times: 10 min for MNNG and 15 min for MMS. We used these conditions because of the extreme sensitivity of some of the mutant strains to these agents. Under these conditions, although the Ada response is only slightly induced (28), the wild-type strain appears to be quite resistant (Figure 2), presumably because the constitutive levels of Tag glycosylase and Ogt methyltransferase are sufficient to prevent toxicity. Mutations in *alkA* and *tag* genes inactivate 3-meA-DNA-glycosylases which efficiently

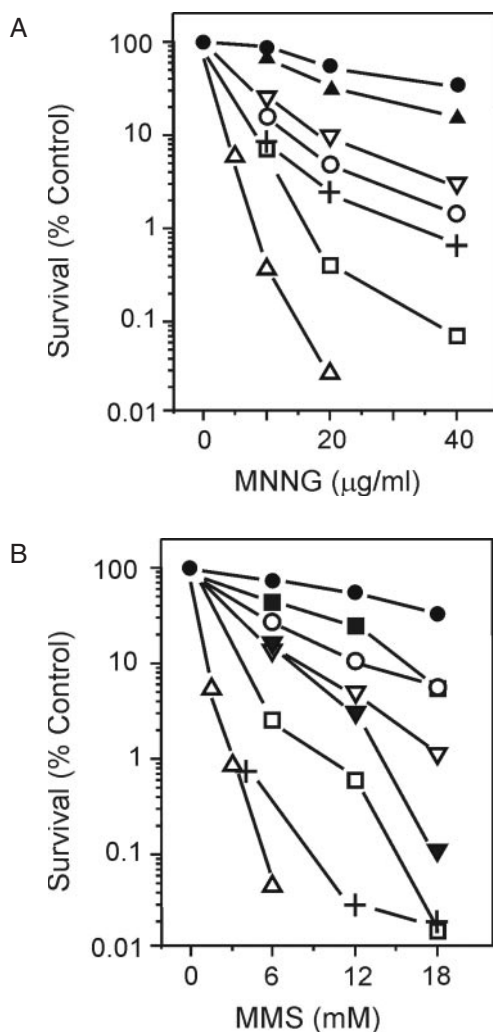

Figure 2. Survival of the wild-type and mutant strains to (A) MNNG and (B) MMS. (A) Wild-type, *alkA*, *alkB* and *tag*, closed circles; *alkB recF*, *alkB recBCD*, closed triangles; *alkA tag* and *alkA recBCD*, open squares; *recBCD*, open circles; *recBCD tag*, inverted open triangles; *alkA tag recBCD*, right-side up open triangles; *alkA tag recF*, crosses. (B) Wild-type, *tag*, *alkB*, closed circles; *alkA*, closed squares; *alkA tag*, *alkB recF*, open squares; *recBCD*, *alkB recBCD*, open circles; *alkA recBCD*, inverted closed triangles; other symbols as for (A).

remove 3-meA from DNA. There was no significant difference between *alkA* or *tag* mutants and the wild-type strain survival after MNNG exposure although there was a small but consistent decrease in survival of the *alkA* strain to MMS (Figure 2). The *alkA tag* double mutant, however, has very low survival after exposure to both agents confirming a previous report (29) but not another (9).

We combined the *alkA* and *tag* mutations separately and together with $\Delta recBCD$ to inquire if there is independence between BER and recombination. For MNNG, the *alkA* mutation, but not *tag*, increased the sensitivity relative to the $\Delta recBCD$ cells (Figure 2A). However, the triple mutant *alkA tag* $\Delta recBCD$ was substantially more sensitive to MNNG than the $\Delta recBCD$ or *alkA tag* parents (Figure 2A). With MMS, the results were similar (Figure 2B). Over-expression of Tag had little effect on survival of *recBCD* strains (data not shown). The results indicate that RecBCD

recombination is important for cell survival and that it appears to act independently from BER by the AlkA and Tag glycosylases under conditions of acute exposure to methylating agents.

The RecF pathway constitutes the second major recombination system in *E. coli*. In contrast to the results with *recBCD*, an *alkA tag recF* strain is more resistant to MNNG than the *alkA tag* double mutant (Figure 2A). This result indicates that the RecBCD system is more important for survival than RecF following MNNG exposure. The increased survival of the *alkA tag recF* mutant may indicate that the RecF enzymes attempt potentially lethal repair on BER substrates in the absence of AlkA and Tag. In response to MMS, however, the *recF* and *recBCD* derivatives of the *alk tag* parent were more sensitive as expected for independent functions for BER and recombination.

In general, the results above suggest that the combined disruption of homologous recombination and DNA glycosylases results in an additive, rather than a synergistic effect. Synergy would be consistent with these pathways acting on the same lesion, whereas an additive result suggests independent substrates. One possibility is that the substrate of recombinational repair changes from BER intermediates to BER substrates when *alkA* and *tag* are knocked out, which would be consistent with the glycosylase step not being rate limiting in BER, as is the case in mammalian cells (30).

Inactivation of the *alkB* gene, which encodes a DNA-dioxygenase, did not change the survival kinetics to MNNG and MMS compared with wild type (Figure 2). The *alkB recBCD* double mutant, however, is more resistant than a *recBCD* strain to MNNG (Figure 2). With MMS, the survival of *recBCD* and *alkB recBCD* strains are similar suggesting that the gene products act in the same pathway of repair. Although the *alkB recF* strain was relatively resistant to MNNG (Figure 2A), it showed a dramatic reduction in survival after MMS exposure (Figure 2B) indicating that RecF pathway enzymes are critical for survival in the absence of AlkB. It is probable that the RecF pathway requirement is to repair gaps in DNA which probably results as a consequence of replication fork stalling at AlkB substrates.

O-Methylation removal enhances cell survival after MNNG exposure

Ada and Ogt are O⁶-methylguanine-DNA-methyltransferases that remove methyl groups from O⁶-meG and O⁴-meT by transferring them to a nucleophilic cysteine residue in their active sites (31). While the methyl group from O⁶-meG is more efficiently removed by Ada, O⁴-meT is repaired more efficiently by Ogt (32). The survival of the *ogt* and *ada* mutants to MMS and MNNG was similar to wild type (Figure 3) while the *ada ogt* double mutant was as resistant as wild type to MMS presumably because little O-methylation is produced under these exposure conditions (Figure 3B). With MNNG, however, the *ada ogt* strain shows increased sensitivity compared with wild type and this is increased further in a $\Delta recBCD$, but not *recF*, genetic background (Figure 3A). The RecBCD and RecF systems are both required for survival but clearly act on different substrates. The *ada* mutation used in these experiments is a Tn10 insertion that has a polar effect on the adjacent *alkB* gene. The effects on survival in Figure 3

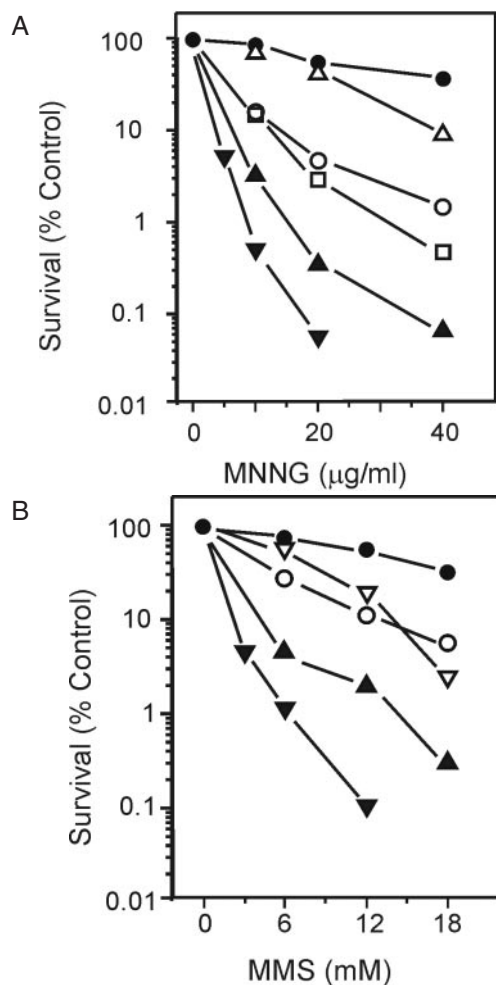

Figure 3. Survival of the wild-type and mutant strains to (A) MNNG and (B) MMS. (A) Wildtype, *ogt*, closed circles; *ada*, right-side up open triangles; *recBCD*, open circles; *ada ogt*, *ada ogt recF*, *ada tag* open squares; *ada ogt recBCD*, right-side up closed triangles; *ada tag recBCD*, inverted closed triangles. (B) Wild-type, *ada*, *ogt*, *ada ogt*, closed circles; *ada ogt recF*, *ada ogt recBCD*, right side up closed triangles; *ada tag*, upside down open triangles; other symbols as for (A).

with MNNG are because of *ada*, and not *alkB*, gene inactivation since the results from Figure 2 indicate that *alkB* mutants are resistant to MNNG.

We next investigated the combined effects of loss of direct reversal and loss of BER in cells lacking homologous recombinational repair of DSBs. Interestingly, an *ada tag* mutant exposed to MNNG had the same survival as the *ada ogt* strain showing that Ogt is comparably as important as Tag (Figure 3A). The *ada tag* strain exposed to MMS, however, was much more sensitive than its *ada ogt* counterpart (Figure 3B) suggesting that expression of the constitutively expressed Tag glycosylase is necessary for survival under conditions that favor formation of its major substrate, 3-meA, over those of Ogt, namely O⁴-meT and O⁶-meG. For both MNNG and MMS treated cells, we observed a significant decrease in survival of the triple mutant, *ada tag recBCD* (Figure 3) compared with *ada tag*, indicating that recombination makes a significant contribution to survival

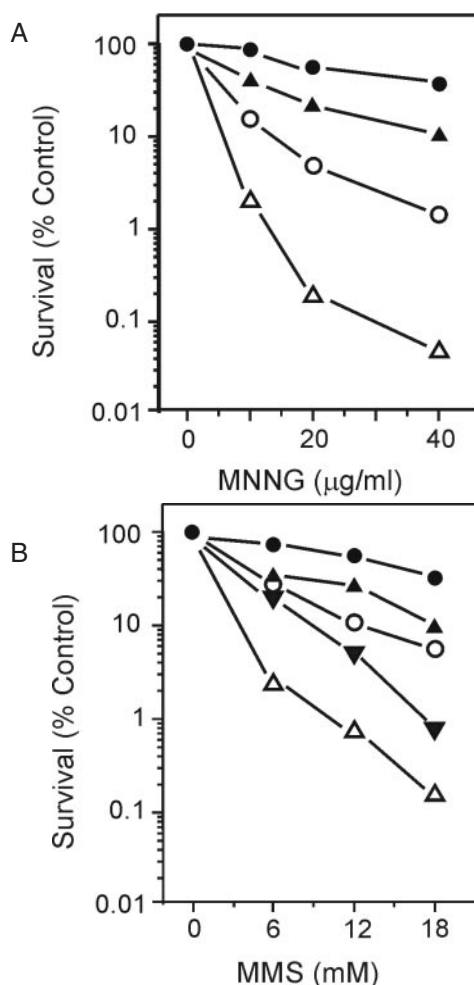

Figure 4. Survival of the wild-type and mutant strains to (A) MNNG and (B) MMS. (A) Wild-type, *recD*, *recN*, *recI*, *recQ*, closed circles; *recBCD*, open circles; *recF*, *recO*, *recR*, right-side up closed triangles; *recN recBCD*, *recQ recBCD*, *recF recBCD*, right-side up open triangles. (B) Wild-type, *recN*, *recQ*, *recI*, *recD*, closed circles; *recBCD*, open circles; *recF*, *recO*, right-side up closed triangles; *recN recBCD*, *recQ recBCD*, upside down closed triangles; *recF recBCD*, right-side up open triangles.

in cells lacking both BER and direct reversal. Although the deletion introduced to disrupt *ada* also eliminates sequences required for *alkB*, the effects in Figure 3 must be because of *ada* and not *alkB* (see Figure 2).

Recombination is critical to prevent toxicity

To learn about the relative importance of DSBs versus single-strand gaps, we compared the methylation-sensitivity of strains lacking essential proteins in the RecBCD and RecFOR systems. RecBCD acts at blunt ends of duplex DNA to resect them and, after encountering a χ sequence, to load RecA (15,18). The RecFOR proteins act at single-stranded gaps to load RecA and they are assisted by the RecJ exonuclease, the RecQ helicase and the RecN protein (19), whose function is not yet well defined (33). Cells with the *recBCD* deletion are more sensitive than wild type after MNNG and MMS exposure (Figure 4). The *recD* variant, which has a hyper-recombination

phenotype but lacks exonuclease activity (18), has a survival similar to the wild type after MNNG or MMS exposure (Figure 4), suggesting that it is specifically RecBCD's role in stimulating homologous recombination that is critical in preventing methylation-induced toxicity.

The *recF*, *recO* and *recR* strains showed the same sensitivity to MMS and MNNG toxicity, consistent with their being in the same pathway (Figure 4). Relative to *recBCD* cells, those lacking either RecF or RecO are more resistant to MNNG, but similarly sensitive to MMS (Figure 4). This difference may reflect the ratio of DSB versus gap-driven recombinational repair. When both pathways were inactivated simultaneously in the *recBCD recF* double mutant, cells are killed by both types of methylating agents at very low concentrations (Figure 4). Disruption of both pathways appears to cause an additive increase in sensitivity, which is consistent with the RecFOR and RecBCD pathways acting on different substrates.

In addition to studies of the *recF*, *O* and *R* components, we also studied the roles of additional genes involved in the RecFOR pathway, namely *recN*, *recQ* and *recJ*. The *recJ*, *recN* and *recQ* strains had survivals similar to wild type but in the absence of RecBCD, the *recN* and *recQ* cells became very sensitive to both MNNG and MMS (Figure 4). This result is consistent with an essential role for these proteins to counteract methylation damage in the absence of the RecBCD system.

In general, *recF* double mutant cells are sensitized further to MMS, but not MNNG, indicating that the RecF pathway is more important for survival to MMS. The RecBCD pathway appears to be equally important for repair of MMS and MNNG damage as *recBCD* double-mutants show increased sensitization to both agents.

Survival of *recA*, *recG*, *ruv* and *lexA* mutants

The RecA protein promotes homologous pairing between DNA molecules during recombination, has a regulatory role in the SOS response through co-protease activity, is required for *in vitro* translesion synthesis by PolV (UmuD'₂C) and it stabilizes blocked replication forks (15,17,18,34). The sensitivity of a *recA* mutant to MMS and MNNG (Figure 5) could be attributed to any or all of these factors.

The only known functions for RuvAB and RuvC are the translocation and cleavage of Holliday junctions respectively making these proteins specifically important to homologous recombination. We found that disruption of *ruvAB* and *ruvC* increased the sensitivity of cells to killing by MNNG (Figure 5A) but not for MMS (Figure 5B). RecG is also a Holliday junction-specific helicase that functions in homologous recombination and we found that the *recG* mutant is more sensitive to both MNNG and MMS compared with wild-type cells (Figure 5). Previous studies have shown that neither the *ruv* nor *recG* mutations individually affect recombination frequencies substantially in conjugational or transductional crosses but any *ruv* mutation combined with *recG* results in severe recombination-deficiency (35). Here, we show that the *recG ruvC* double mutant is far more sensitive to killing by methylating agents than are the single mutants (Figure 5), suggesting that recombination modulated by both RecG and RuvC is required for resistance to MMS and MNNG.

We expected that induction of some SOS genes involved in recombination such as *recA*, *ruvA* and *ruvB*, might be needed

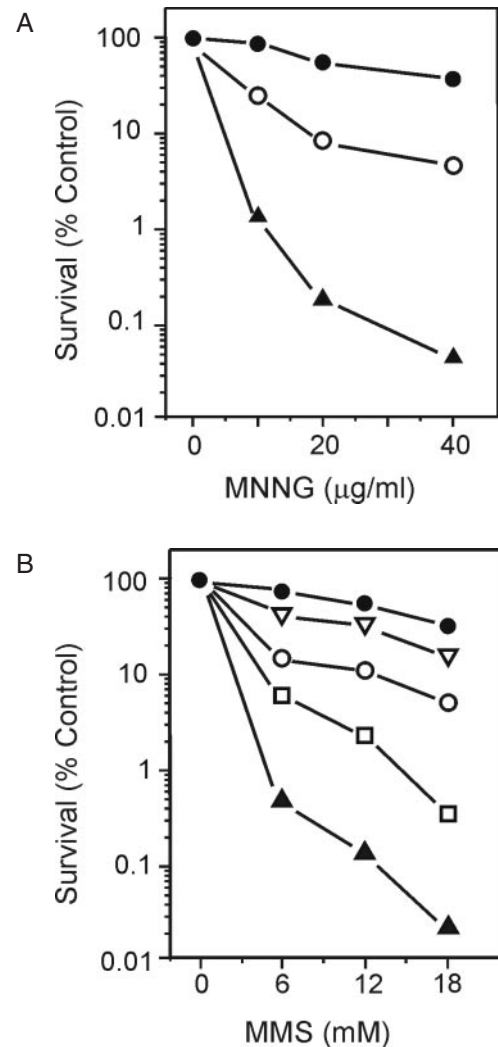

Figure 5. Survival of the wild-type and mutant strains to (A) MNNG and (B) MMS. (A) Wild-type, closed circles; *ruvABC*, *recG*, *ruvC*, open circles; *ruvC* *recA*, *recA*, right-side up closed triangles. (B) *recA*, open squares, *ruvC*, upside down open triangles. Other symbols as for (A).

to repair methylation damage but a *lexA3* (*Ind*⁻) strain (SOS genes constitutively repressed) had wild-type survival to MNNG and MMS (Figure 6). The results are consistent with a model in which basal levels of recombination proteins such as RecA and RuvA and RuvB are sufficient to cope with the level of DSBs produced after acute low-level exposure to methylating agent damage. The resistance of the *lexA3* (*Ind*⁻) strain to methylating agents also indicates that the sensitivity of a *recA* mutant to methylating agents is not because of its role in the SOS response or TLS. It also indicates that SOS-inducible bypass translesion polymerases do not play a significant role in survival to methylation damage although it is possible, but unlikely, that basal levels of these enzymes are sufficient to cope with the damage inflicted on DNA.

Recombination-deficient *xthA nfo* strains

Mutation of the *xthA* and *nfo* genes inactivates the major and minor AP endonucleases of *E.coli* (36), and the *xthA nfo*

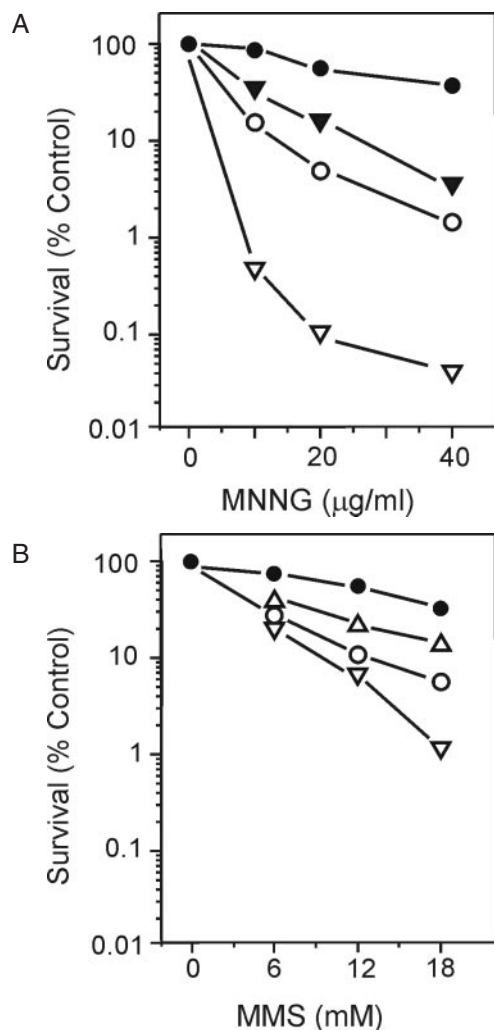

Figure 6. Survival of the wild-type and mutant strains to (A) MNNG and (B) MMS. (A) Wild-type, *lexA3*, *uvrA*, *uvrD*, *sfiA*, closed circles; *recBCD*, open circles; *sfiA priA*, upside down open triangles. (B) Wild-type, *uvrA*, *uvrD*, closed circles; *lexA3*, right side up open triangles; *recBCD*, open circles; *sfiA*, upside down open triangles.

double-mutant strain is more sensitive to methylation damage after acute exposure than wildtype and the effect is greater for MMS than MNNG (Figure 7). An *xthA nfo recF* strain is very sensitive to MMS (Figure 7B) but less so to MNNG (Figure 7A) indicating that recombination is essential in the absence of AP-endonucleases presumably owing to the presence of abasic sites which block replication fork progression. The result also indicates that MMS produces more substrate requiring the RecF system than MNNG and this substrate is probably single-strand gaps. We were unable to test the contribution of RecBCD since *xthA nfo recB270* (Ts) cells are inviable at the non-permissive temperature (Table 3).

It was shown previously (36) that chronic exposure of *xthA nfo* bacteria to MMS reduces survival to a greater extent than that for acute exposure. Upon chronic exposure to MMS (cells on gradient plates), we found that *xthA nfo* bacteria are more sensitive to MMS and MNNG than wild type and their survival was almost identical to a *recBCD* strain (data not shown) which is consistent with previous studies and confirms that

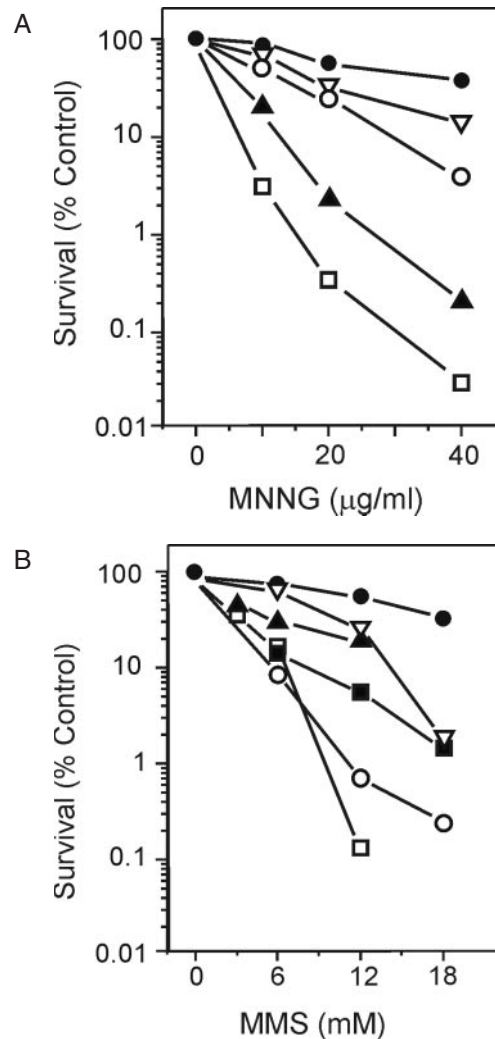

Figure 7. Survival of the wildtype and mutant strains to (A) MNNG and (B) MMS. (A) Wild-type, *xth*, *nfo*, *polA/F*⁺*polA*⁺, closed circles; *polA*, open squares; *polA/F* Klenow fragment, *polA/5'-3' exo*, right-side up closed triangles; *xthA nfo*, upside down open triangles; *xth nfo recF*, open circles. (B) Wild-type, *xth*, *nfo*, *polA/F*⁺*polA*⁺, closed circles; *polA*, open squares; *polA/F* Klenow fragment, right-side up closed triangles; *polA/5'-3' exo*, solid squares; *xthA nfo*, upside down open triangles; *xthA nfo recF*, open circles.

AP-endonuclease action is important for cellular survival to methylating agents (36).

DNA polymerase I and PriA promote cell survival after treatment with MNNG and MMS

When a new replication fork is reassembled following replication fork collapse or destruction, it is necessary to reload the replicative DNA polymerase holoenzyme using PriA, PriB, PriC and DnaT proteins, referred to here as the PriA pathway. Mutants such as *priA* are constitutively activated for the SOS response and need to be investigated in a *sfiA* (*sulA*) background to prevent lethal filamentation (37). The *priA* mutation also imparts a recombination-deficient phenotype (38). The *priA sfiA* strain is very sensitive to MNNG showing similar survival to that for *recBCD recF* and *ruvC recG* suggesting that either replication restart, or recombination or both are

necessary for cells to resist methylation damage. The strain is less sensitive to MMS which is consistent with a reduced role for RecBCD recombination followed by replication-restart compared with RecF recombination at gaps. The *sfiA* mutation does not alter survival compared with the wild-type allele (Figure 6A).

DNA polymerase I is involved in BER and NER by nick-translation or gap filling respectively and it is expected to play an important role in completing BER following base removal by AlkA or Tag action. PolI has also been implicated as being essential for intrachromosomal recombination (39). We found that the $\Delta polA$ strain is extremely sensitive to both MMS and MNNG to about the same degree as the most sensitive strains we have studied, such as *alkA tag* and *recG ruvC* (Figure 7). The effect is specific to *polA* since the $F'polA^+/\Delta polA$ derivative is as resistant to methylation-induced killing as wild-type cells are (Figure 7). Expression of either the 5'-3'-exonuclease or the Klenow domain in a $\Delta polA$ strain did not result in wild-type survival indicating that both these activities are required for resistance to methylating agents (Figure 7). Our results with the $\Delta polA$ strain are in contrast to the modest sensitivity to MMS previously reported for strains with *polA* nonsense and mis-sense mutations (40,41).

DISCUSSION

We have summarized the data obtained in the Results section in Table 2 and the strains have been placed into three groups on the basis of sensitivity to methylating agents. A striking result is the sensitivity of strains with single mutations in genes affecting recombination (*recA*, *priA*) compared with those affecting BER (*ada*, *tag*, *ogt*). Apart from the BER-defective *alkA tag* double mutant, this correlation becomes more striking for cells with multiple mutations affecting recombination (e.g. *recBCD recF*, *recBCD alkA tag*). We conclude that homologous recombination is essential for the repair or tolerance of methylated lesions in DNA.

In addition to conditions where cells were exposed to an acute low dose of methylating agent, we have also tested the effect of chronic exposure by growing cells on solid media for 2 days in a concentration gradient of MMS or MNNG ('gradient plates'). The results were in agreement with

those for acute exposure (Figures 2–7) except for the strains with *ada-alkB*, *alkA*, *ada ogt* and *xthA nfo* mutations which showed a greater sensitivity after chronic versus acute exposure (data not shown). The *recF* strain, on the other hand, was more resistant to chronic than acute exposure to methylating agents. We also found that overexpression of Tag or Ada did not change survival in *recBCD* cells (data not shown).

It is remarkable that strains deficient in recombination, such as *recA*, *recBCD recF* and *ruvC recG*, are as sensitive to methylating agents as BER repair-deficient *alkA tag* bacteria. This observation indicates that recombination is as important as BER for cells to repair damage inflicted by MMS and MNNG. Both RecBCD and RecFOR pathways are required (Figure 4) but since the survival of the *recBCD recF* double mutant is less than each alone, they act independently of each other. This is not unexpected given that RecBCD is involved primarily in DSB repair and RecFOR in the repair of gaps (15,18,34,42). The requirement for both of these recombination systems is compatible with at least two types of methylation-induced damage requiring recombinational repair. Although DNA single-strand breaks have been detected after alkylation damage, there is no evidence that these agents directly form DSBs. It is more probable that the single-strand breaks or replication-blocking lesions are converted to DSBs during DNA replication.

DNA single-strand breaks could arise in methylated DNA by at least two mechanisms. First, AlkA or Tag glycosylase action forms abasic sites and then AP endonuclease activity cleaves the DNA backbone. Second, abasic sites that are produced after spontaneous 7-meG depurination eventually become substrates for AP endonucleases. The independence of AlkA or Tag-mediated BER from homologous recombination suggests that the second possibility is more likely. It is probable that nicks generated by AP endonucleases, which require additional processing by deoxyribosephosphodiesterases, are longer lived than simple ligatable nicks with a 3'-OH and a 5'-phosphate and so there is a greater chance that they will be encountered by a replication fork. If these nicks are encountered by a replication fork, they will produce replication fork collapse, generating substrates for RecBCD pathway recombination (43). During re-construction of the fork, the PriA pathway proteins reload the DNA polymerase III holoenzyme (37). This explanation could account for the

Table 2. Sensitivity of GM7330 derivatives to acute MNNG and MMS exposure

| Sensitivity | MNNG | MMS |
|--|---|---|
| Like wild-type survival | <i>alkA</i> , <i>alkB</i> , <i>tag</i> , <i>ada</i> , <i>ogt</i> , <i>recJ</i> , <i>recN</i> , <i>recQ</i> , <i>recD</i> , <i>lexA3</i> , <i>uvrA</i> , <i>sfiA</i> , <i>polA</i> / $F' polA^+$, <i>xthA</i> , <i>nfo</i> , <i>alkB recF</i> , <i>alkB recBCD</i> | <i>alkB</i> , <i>tag</i> , <i>ada</i> , <i>ogt</i> , <i>ada ogt</i> , <i>ruvC</i> , <i>uvrD</i> , <i>recJ</i> , <i>recN</i> , <i>recQ</i> , <i>recD</i> , <i>lexA3</i> , <i>uvrA</i> , <i>polA</i> / $F' polA^+$, <i>xthA</i> , <i>nfo</i> |
| Moderately sensitive (similar to <i>recBCD</i>) | <i>recBCD</i> , <i>recFOR</i> , <i>ruvABC</i> , <i>ruvC</i> , <i>recG</i> , <i>uvrD</i> , <i>recBCD tag</i> , <i>recF alk tag</i> , <i>recF ada ogt</i> , <i>xthA nfo recF</i> | <i>recBCD</i> , <i>recFOR</i> , <i>alkA</i> , <i>recG</i> , <i>ada tag</i> , <i>alkB recBCD</i> , <i>priA sfiA</i> |
| Very sensitive | <i>polA</i> , <i>recA</i> , <i>priA sfiA</i> , <i>ada ogt</i> , <i>ada tag</i> , <i>alkA tag</i> , <i>ruvC recG</i> , <i>recBCD recN</i> , <i>recBCD</i> , <i>recQ</i> , <i>recBCD recF</i> , <i>recBCD alkA</i> , <i>recBCD ada tag</i> , <i>recBCD alkA tag</i> , <i>recBCD ada ogt</i> | <i>polA</i> , <i>recA</i> , <i>alkA tag</i> , <i>ruvC recG</i> , <i>recF alk tag</i> , <i>recF ada ogt</i> , <i>recF alkB</i> , <i>xthA nfo recF</i> , <i>recBCD recN</i> , <i>recBCD</i> , <i>recQ</i> , <i>recBCD recF</i> , <i>recBCD alkA</i> , <i>recBCD tag</i> , <i>recBCD ada tag</i> , <i>recBCD alkA tag</i> , <i>recBCD ada ogt</i> |

sensitivity of *priA* mutants to methylation-induced toxicity, since such cells would be less capable in restoring collapsed replication forks (Figure 6).

Although it is clearly the case that a single-strand break formed during BER could potentially cause replication fork breakdown, unrepaired base damage is also potentially recombinogenic. For example, unrepaired 3-meA can block replicative polymerase progression (5). Indeed, we observed that there is an enormous increase in the sensitivity of *recBCD* mutant cells when AlkA and Tag are deleted, presumably because unrepaired 3-meA causes formation of DSBs. Similarly, abasic sites arising from N7-methylguanine depurination, for example, also block replicative polymerase progression (44–47). The viability of *xthA nfo recF* cells and their poor survival after MMS exposure (Figure 7B) is consistent with RecBCD-promoted DSB repair at stalled replication forks at abasic sites. The inviability of *xthA nfo recBCD* bacteria (Table 3) is probably due to replication fork problems at spontaneously occurring abasic sites or blocking lesions. We speculate that this effect is magnified after methylation damage based on the increased susceptibility of *xthA nfo* cells chronically exposed to MMS and MNNG. Regardless of the underlying mechanism of methylation-induced recombination, the data presented here are consistent with both unrepaired methylation damage and BER repair intermediates inducing DSBs.

Our conclusions regarding the role of AP-endonucleases in promoting recombinational repair are similar to those reached by Wang and Chang (23). These authors found that *xthA nfo nth* (endonuclease III) mutants were more sensitive than wild-type to MMS and that *recA* and *recB*, derivatives could not be constructed but that a *recF* derivative could be. Although there are some differences between their data and ours, we agree that methylated bases produce secondary lesions that require the function of the *recA* and *recB* genes to ensure survival.

Our observations suggest that there is a difference between MNNG and MMS in recombinational repair of DSBs and gaps. The most compelling data are the responses of the *alkB recF* (Figure 2) and *xthA nfo recF* cells (Figure 7). The *alkB recF* cells show wild-type resistance to MNNG but high sensitivity to MMS. The *xthA nfo recF* bacteria are more sensitive to MMS than MNNG suggesting that DSB repair is more important after MNNG damage than gap repair and vice versa for MMS. The basis for these differences between MNNG and MMS is not clear as the amounts of N-methylated residues formed in DNA are not very different (12) except for 4-fold increases in N1-methyladenine and N3-methylcytosine (AlkB substrates) by MMS versus MNNG. It is clear from these results, however, that the requirement for RecF recombination is greater in cells exposed to MMS than MNNG. MNNG produces more O-methylated bases than MMS which probably explains why *ada ogt* cells are more

sensitive to MNNG than MMS (Figure 3) and may indicate that these O-methylated bases act as lethal lesions as previously suggested (29). This suggestion is supported by our data in Figures 2 and 3 which, because of the wild-type survival of *ada*-regulated gene disruptions (*alkA*, *alkB*), can be interpreted as indicating that it is the methyltransferase, and not the regulatory function, of Ada that is important. We speculate that, at least some of the time, O-methylated bases block progression of the replication fork and promoting fork stalling, collapse or breakage. The results with the *ada ogt* and *alkA tag* double mutants suggest that AlkA, Tag, Ada and Ogt are all required to promote survival after MNNG challenge while survival after MMS exposure is dependent predominantly on the *alkA* and *tag* genes products (Figure 2B). These results are consistent with previous observations (1,8).

One unexpected and very interesting result of these studies was the observation that *polA* mutant cells are extremely sensitive to methylating agents (Figure 7). Although MMS sensitivity of *polA* mis-sense and nonsense mutants has been described previously [e.g. (41)], the degree of killing was much less than that for the *polA* deletion mutant. This result suggests that PolI may have functions other than simply nick translation in BER or gap filling in NER. PolI is essential for intrachromosomal recombination initiated by a DSB (39) and, therefore, it could also be required for DSB repair after methylation damage to DNA. Our data (Figure 7) suggest that both 3'-5' exonuclease and Klenow fragment functions are required for resistance to methylation damage.

The increased sensitivity of the *alkA tag* double mutant versus the single mutants likely reflects the redundancy of the glycosylases in repairing damage. Alternatively, the decreased survival might indicate that when replication-blocking methylated bases persist in DNA, recombination becomes a major mechanism for the cell to tolerate such lesions. This explanation is similar to that proposed for the repair of ultraviolet damage in *uvr* mutants deficient in NER (48) where single-strand gaps occur on both leading and lagging strand which have to be filled by recombination. The data presented here suggest that such gaps are also formed after methylation damage and repaired by the RecFOR system. These gaps could arise at a blocking lesion by decoupling leading and lagging strand polymerase assemblies (46,49) allowing further lagging strand synthesis followed by re-initiation of replication after PriC loading of DnaB (50).

We were surprised to observe that the *uvrD* strain showed moderate sensitivity to MNNG (Figure 6A). The UvrD helicase performs essential steps in NER and mismatch repair (MMR). Since NER is not involved in repair of methylated lesions (consistent with the fact that disruption of the *uvrA* gene does not sensitize cells to methylation damage, Figure 6) and MMR effects occur predominantly in *dam* mutants, it is unlikely that the sensitivity of the *uvrD* mutant is because of these processes. Alternatively, it is possible that UvrD helicase action may be necessary for DSB repair by recombination as UvrD-deficiency has been reported to affect recombination (51). In addition to its involvement in NER and MMR, UvrD has recently been implicated in replication fork reversal (52). These results, therefore, suggest the possibility that fork reversal at replication-blocking lesions, such as 3-meA, may require UvrD or that this helicase is required for recombination during repair of methylation-induced DSBs.

Table 3. Inviability of *recB* AP endonuclease-deficient bacteria

| Strain | Genotype | Ratio CFU 42°/30° | Ratio CFU 37°/30° |
|--------|-------------------------|---|-------------------|
| GM8487 | <i>xthA nfo recB270</i> | $1.6 \times 10^{-5} \pm 0.8 \times 10^{-5}$ | 0.9 ± 0.18 |
| GM7836 | <i>recB270</i> | 0.8 ± 0.19 | 1.0 ± 0.17 |

In conclusion, our results suggest that recombination is essential to repair both DSBs and single-strand gaps after methylation damage. DSBs result from replication fork problems at single-strand nicks resulting from AP-endonuclease action, and from replication-blocking lesions such as 3-methyladenine, abasic sites and O-methylated bases. A prediction of the genetic data presented in this paper is that DSBs should be formed in cells exposed to MNNG as a consequence of DNA replication and we are currently seeking evidence for this prediction.

ACKNOWLEDGEMENTS

The authors thank all the investigators listed in Table 1 for donating bacterial strains. The authors also thank Anita Fenton for constructing the *tag::Tet* strain. This work was supported by grants GM63790 (M.G.M) and R01 CA79827 and ES07020 (S.S. and B.P.E.), from the National Institutes of Health. Funding to pay the Open Access publication charges for this article was provided by the National Institutes of Health.

Conflict of interest statement. None declared.

REFERENCES

- Sedgwick, B. (2004) Repairing DNA-methylation damage. *Nat. Rev. Mol. Cell Biol.*, **5**, 148–157.
- Strauss, B., Scudiero, D. and Henderson, E. (1975) The nature of the alkylation lesion in mammalian cells. *Basic Life Sci.*, **5A**, 13–24.
- Loechler, E.L., Green, C.L. and Essigmann, J.M. (1984) *In vivo* mutagenesis by O6-methylguanine built into a unique site in a viral genome. *Proc. Natl Acad. Sci. USA*, **81**, 6271–6275.
- Boiteux, S. and Laval, J. (1982) Mutagenesis by alkylating agents: coding properties for DNA polymerase of poly (dC) template containing 3-methylcytosine. *Biochimie*, **64**, 637–641.
- Larson, K., Sahn, J., Shenkar, R. and Strauss, B. (1985) Methylation-induced blocks to *in vitro* DNA replication. *Mutat. Res.*, **150**, 77–84.
- Kleibl, K. (2002) Molecular mechanisms of adaptive response to alkylating agents in *Escherichia coli* and some remarks on O(6)-methylguanine DNA-methyltransferase in other organisms. *Mutat. Res.*, **512**, 67–84.
- Drablos, F., Feyzi, E., Aas, P.A., Vaagbo, C.B., Kavli, B., Bratlie, M.S., Pena-Diaz, J., Otterlei, M., Slupphaug, G. and Krokan, H.E. (2004) Alkylation damage in DNA and RNA-repair mechanisms and medical significance. *DNA Repair (Amst)*, **3**, 1389–1407.
- Lindahl, T., Sedgwick, B., Sekiguchi, M. and Nakabeppu, Y. (1988) Regulation and expression of the adaptive response to alkylating agents. *Annu. Rev. Biochem.*, **57**, 133–157.
- Takano, K., Nakamura, T. and Sekiguchi, M. (1991) Roles of two types of O6-methylguanine-DNA methyltransferases in DNA repair. *Mutat. Res.*, **254**, 37–44.
- Seeberg, E., Eide, L. and Bjoras, M. (1995) The base excision repair pathway. *Trends Biochem. Sci.*, **20**, 391–397.
- Wyatt, M.D., Allan, J.M., Lau, A.Y., Ellenberger, T.E. and Samson, L.D. (1999) 3-methyladenine DNA glycosylases: structure, function, and biological importance. *Bioessays*, **21**, 668–676.
- Trewick, S.C., Henshaw, T.F., Hausinger, R.P., Lindahl, T. and Sedgwick, B. (2002) Oxidative demethylation by *Escherichia coli* AlkB directly reverts DNA base damage. *Nature*, **419**, 174–178.
- Falnes, P.O., Johansen, R.F. and Seeberg, E. (2002) AlkB-mediated oxidative demethylation reverses DNA damage in *Escherichia coli*. *Nature*, **419**, 178–182.
- Landini, P. and Volkert, M.R. (2000) Regulatory responses of the adaptive response to alkylation damage: a simple regulon with complex regulatory features. *J. Bacteriol.*, **182**, 6543–6549.
- Kowalczykowski, S.C. (2000) Initiation of genetic recombination and recombination-dependent replication. *Trends Biochem. Sci.*, **25**, 156–165.
- Shanabru, W.G., Rein, R.P., Behlau, I. and Walker, G.C. (1983) Mutagenesis, by methylating and ethylating agents, in *mutH*, *mutL*, *mutS*, and *uvrD* mutants of *Salmonella typhimurium* LT2. *J. Bacteriol.*, **153**, 33–44.
- Sutton, M.D., Smith, B.T., Godoy, V.G. and Walker, G.C. (2000) The SOS response: recent insights into *umuDC*-dependent mutagenesis and DNA damage tolerance. *Annu. Rev. Genet.*, **34**, 479–497.
- Kuzminov, A. (1999) Recombinational repair of DNA damage in *Escherichia coli* and bacteriophage lambda. *Microbiol. Mol. Biol. Rev.*, **63**, 751–813, table.
- Morimatsu, K. and Kowalczykowski, S.C. (2003) RecFOR proteins load RecA protein onto gapped DNA to accelerate DNA strand exchange: a universal step of recombinational repair. *Mol. Cell*, **11**, 1337–1347.
- Lovett, S.T. and Clark, A.J. (1984) Genetic analysis of the *recJ* gene of *Escherichia coli* K-12. *J. Bacteriol.*, **157**, 190–196.
- Nakayama, H., Nakayama, K., Nakayama, R., Irino, N., Nakayama, Y. and Hanawalt, P.C. (1984) Isolation and genetic characterization of a thymineless death-resistant mutant of *Escherichia coli* K12: identification of a new mutation (*recQ1*) that blocks the RecF recombination pathway. *Mol. Gen. Genet.*, **195**, 474–480.
- Sharples, G.J., Ingleston, S.M. and Lloyd, R.G. (1999) Holliday junction processing in bacteria: insights from the evolutionary conservation of RuvABC, RecG, and RuvA. *J. Bacteriol.*, **181**, 5543–5550.
- Wang, T.C. and Chang, H.Y. (1991) Effect of *rec* mutations on viability and processing of DNA damaged by methylmethane sulfonate in *xth nfo* cells of *Escherichia coli*. *Biochem. Biophys. Res. Commun.*, **180**, 774–781.
- Murphy, K.C., Campellone, K.G. and Poteete, A.R. (2000) PCR-mediated gene replacement in *Escherichia coli*. *Gene*, **246**, 321–330.
- Posnick, L.M. and Samson, L.D. (1999) Imbalanced base excision repair increases spontaneous mutation and alkylation sensitivity in *Escherichia coli*. *J. Bacteriol.*, **181**, 6763–6771.
- Demple, B., Sedgwick, B., Robins, P., Totty, N., Waterfield, M.D. and Lindahl, T. (1985) Active site and complete sequence of the suicidal methyltransferase that counters alkylation mutagenesis. *Proc. Natl Acad. Sci. USA*, **82**, 2688–2692.
- Davis, B.D. and Mingioli, E.S. (1951) Mutants of *Escherichia coli* requiring methionine or vitamin B12. *J. Bacteriol.*, **60**, 17.
- Demple, B. (1986) Mutant *Escherichia coli* Ada proteins simultaneously defective in the repair of O6-methylguanine and in gene activation. *Nucleic Acids Res.*, **14**, 5575–5589.
- Rebeck, G.W. and Samson, L. (1991) Increased spontaneous mutation and alkylation sensitivity of *Escherichia coli* strains lacking the *ogt* O6-methylguanine DNA repair methyltransferase. *J. Bacteriol.*, **173**, 2068–2076.
- Beard, W.A., Shock, D.D. and Wilson, S.H. (2004) Influence of DNA structure on DNA polymerase beta active site function: extension of mutagenic DNA intermediates. *J. Biol. Chem.*, **279**, 31921–31929.
- Lindahl, T., Demple, B. and Robins, P. (1982) Suicide inactivation of the *E. coli* O6-methylguanine-DNA methyltransferase. *EMBO J.*, **1**, 1359–1363.
- Sassanfar, M., Doshan, M.K., Essigmann, J.M. and Samson, L. (1991) Relative efficiencies of the bacterial, yeast, and human DNA methyltransferases for the repair of O6-methylguanine and O4-methylthymine. Suggestive evidence for O4-methylthymine repair by eukaryotic methyltransferases. *J. Biol. Chem.*, **266**, 2767–2771.
- Meddows, T.R., Savory, A.P., Grove, J.I., Moore, T. and Lloyd, R.G. (2005) RecN protein and transcription factor DksA combine to promote faithful recombinational repair of DNA double-strand breaks. *Mol. Microbiol.*, **57**, 97–110.
- McGlynn, P. and Lloyd, R.G. (2002) Recombinational repair and restart of damaged replication forks. *Nat. Rev. Mol. Cell Biol.*, **3**, 859–870.
- Lloyd, R.G. (1991) Conjugal recombination in resolvase-deficient *ruvC* mutants of *Escherichia coli* K-12 depends on *recG*. *J. Bacteriol.*, **173**, 5414–5418.
- Cunningham, R.P., Saporito, S.M., Spitzer, S.G. and Weiss, B. (1986) Endonuclease IV (*nfo*) mutant of *Escherichia coli*. *J. Bacteriol.*, **168**, 1120–1127.
- Sandler, S.J. and Marians, K.J. (2000) Role of PriA in replication fork reactivation in *Escherichia coli*. *J. Bacteriol.*, **182**, 9–13.

38. Kogoma, T., Cadwell, G.W., Barnard, K.G. and Asai, T. (1996) The DNA replication priming protein, PriA, is required for homologous recombination and double-strand break repair. *J. Bacteriol.*, **178**, 1258–1264.
39. Nowosielska, A., Calmann, M.A., Zdraveski, Z., Essigmann, J.M. and Marinus, M.G. (2004) Spontaneous and cisplatin-induced recombination in *Escherichia coli*. *DNA Repair (Amst)*, **3**, 719–728.
40. De Lucia, P. and Cairns, J. (1969) Isolation of an *E.coli* strain with a mutation affecting DNA polymerase. *Nature*, **224**, 1164–1166.
41. Konrad, E.B. and Lehman, I.R. (1974) A conditional lethal mutant of *Escherichia coli* K12 defective in the 5' leads to 3' exonuclease associated with DNA polymerase I. *Proc. Natl Acad. Sci. USA*, **71**, 2048–2051.
42. Kreuzer, K.N. (2005) Interplay between DNA replication and recombination in prokaryotes. *Annu. Rev. Microbiol.*, **59**, 43–67.
43. Kuzminov, A. (2001) Single-strand interruptions in replicating chromosomes cause double-strand breaks. *Proc. Natl Acad. Sci. USA*, **98**, 8241–8246.
44. Bonner, C.A., Randall, S.K., Rayssiguier, C., Radman, M., Eritja, R., Kaplan, B.E., McEntee, K. and Goodman, M.F. (1988) Purification and characterization of an inducible *Escherichia coli* DNA polymerase capable of insertion and bypass at abasic lesions in DNA. *J. Biol. Chem.*, **263**, 18946–18952.
45. Hevroni, D. and Livneh, Z. (1988) Bypass and termination at apurinic sites during replication of single-stranded DNA *in vitro*: a model for apurinic site mutagenesis. *Proc. Natl Acad. Sci. USA*, **85**, 5046–5050.
46. Higuchi, K., Katayama, T., Iwai, S., Hidaka, M., Horiuchi, T. and Maki, H. (2003) Fate of DNA replication fork encountering a single DNA lesion during *oriC* plasmid DNA replication *in vitro*. *Genes Cells*, **8**, 437–449.
47. Lawrence, C.W., Borden, A., Banerjee, S.K. and LeClerc, J.E. (1990) Mutation frequency and spectrum resulting from a single abasic site in a single-stranded vector. *Nucleic Acids Res.*, **18**, 2153–2157.
48. Rupp, W.D. and Howard-Flanders, P. (1968) Discontinuities in the DNA synthesized in an excision-defective strain of *Escherichia coli* following ultraviolet irradiation. *J. Mol. Biol.*, **31**, 291–304.
49. Pages, V. and Fuchs, R.P. (2003) Uncoupling of leading- and lagging-strand DNA replication during lesion bypass *in vivo*. *Science*, **300**, 1300–1303.
50. Heller, R.C. and Marians, K.J. (2005) The disposition of nascent strands at stalled replication forks dictates the pathway of replisome loading during restart. *Mol. Cell*, **17**, 733–743.
51. Zieg, J., Maples, V.F. and Kushner, S.R. (1978) Recombinant levels of *Escherichia coli* K-12 mutants deficient in various replication, recombination, or repair genes. *J. Bacteriol.*, **134**, 958–966.
52. Flores, M.J., Bidnenko, V. and Michel, B. (2004) The DNA repair helicase UvrD is essential for replication fork reversal in replication mutants. *EMBO Rep.*, **5**, 983–988.