



Goldfish morphology as a model for evolutionary developmental biology

Kinya G. Ota* and Gembu Abe

Morphological variation of the goldfish is known to have been established by artificial selection for ornamental purposes during the domestication process. Chinese texts that date to the Song dynasty contain descriptions of goldfish breeding for ornamental purposes, indicating that the practice originated over one thousand years ago. Such a well-documented goldfish breeding process, combined with the phylogenetic and embryological proximities of this species with zebrafish, would appear to make the morphologically diverse goldfish strains suitable models for evolutionary developmental (evodevo) studies. However, few modern evodevo studies of goldfish have been conducted. In this review, we provide an overview of the historical background of goldfish breeding, and the differences between this teleost and zebrafish from an evolutionary perspective. We also summarize recent progress in the field of molecular developmental genetics, with a particular focus on the twin-tail goldfish morphology. Furthermore, we discuss unanswered questions relating to the evolution of the genome, developmental robustness, and morphologies in the goldfish lineage, with the goal of blazing a path toward an evodevo study paradigm using this teleost species as a new model species. © 2016 The Authors. *WIREs Developmental Biology* published by Wiley Periodicals, Inc.

How to cite this article:

WIREs Dev Biol 2016, 5:272–295. doi: 10.1002/wdev.224

INTRODUCTION

The goldfish (*Carassius auratus*) is a well-known, ornamental, domesticated teleost species, which consists of a number of morphologically divergent strains (Figure 1). Because of the morphological attractiveness of the goldfish, this teleost species has spread all over the world, where it is bred by breeders and fanciers.^{2–5} Such extensive diversity makes goldfish particularly advantageous as a model organism, as we discuss below. The domestication

processes of goldfish strains have been documented by authors in many different countries using different languages.^{1–9} Of these reports, the descriptions by Smartt² are the most up-to-date and cover the widest range of the literature. Although detailed descriptions of the cultural historical background of goldfish breeding from the middle ages to the early modern period of China are out of the scope of this review, this article begins with a brief recap of earlier reviews which will help indicate the length of time that goldfish have been under artificial selection.

It is assumed that the origin of goldfish breeding is correlated with paddy rice cultivation, which required water storage, thereby providing a habitat for the fish.² Although it is not clear why people started to breed goldfish, it is possible that they were initially maintained as a high protein source in rice fields and irrigation ponds; this is plausible, as

*Correspondence to: otakinya@gate.sinica.edu.tw

Laboratory of Aquatic Zoology, Marine Research Station, Institute of Cellular and Organismic Biology, Academia Sinica, Yilan, Taiwan

Conflict of interest: The authors have declared no conflicts of interest for this article.

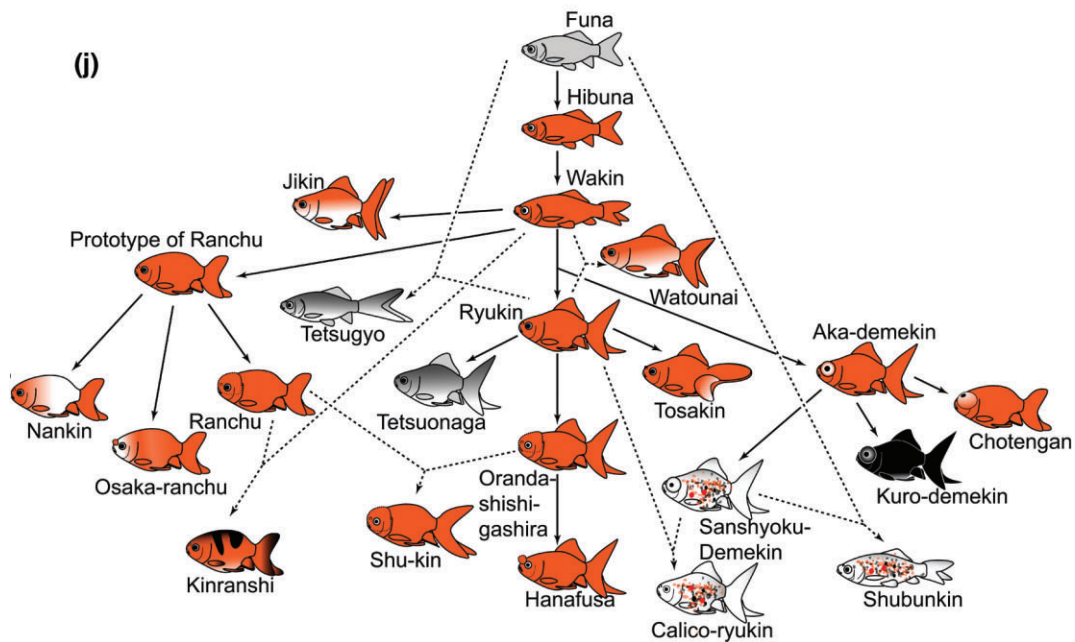
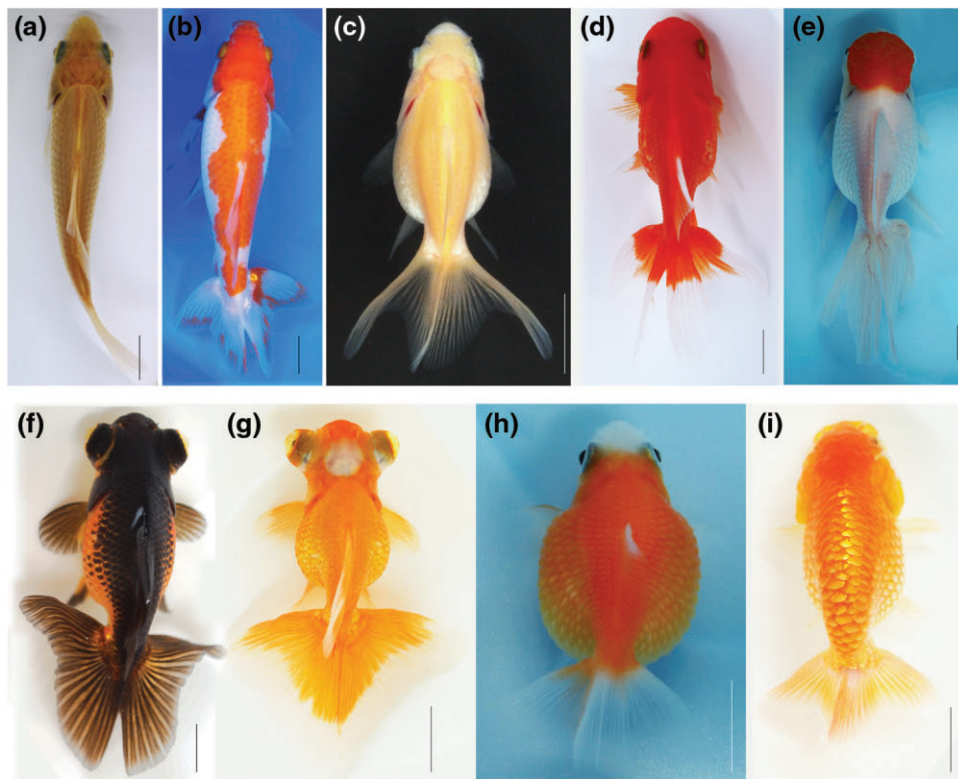

FIGURE 1 | Variation of goldfish strains. (a–i) Dorsal views of nine different goldfish strains: (a) the single fin Wakin; (b) duplicated caudal fin Wakin; (c) Ryukin; (d) Oranda; (e) Redcap Oranda; (f) telescope (the ‘black moutan’ strain); (g) telescope (butterfly tail); (h) red-color telescope; and (i) Ranchu (Reprinted with permission from Ref 27. Copyright 2014). (j) Illustration of Matsui’s genealogical diagram.¹ The name of each strain is based on Ref 1. Solid and dotted lines indicate spontaneous mutation and hybridization of different strains, respectively.

goldfish and its relatives have long been popular as food sources in areas influenced by Chinese culture.² There is greater uncertainty about the subsequent

history; however, it is hypothesized that the color mutant goldfish may have been maintained and released into ponds from the Qin to Tang dynasty

periods, due to their rarity in nature, and for religious reasons.^{2,8,9} During this period, the selective pressure on goldfish morphology appears to have been relatively weak.

It is believed that strong artificial selection of goldfish morphological features may have begun in the Song dynasty (960–1279) (Figure 2), because certain publications provide evidence that goldfish domestication for ornamental purposes began in earnest at this time.² Subsequently, the twin-tail goldfish and some other fin and eye morphology mutants were documented during the Ming (1368–1598) and Qing (1644–1912) dynasties.^{2,8} It is assumed that almost all mutants with changes in internal skeletal morphologies (twin-tail, dorsal finless, globular body shape, and pop-eye) were established during these era, based on descriptions in the relevant archives.^{2,8} The establishment of such morphologically diverse strains in this early period of goldfish domestication is significant in an evodevo context, as such strains provided 19th century biologists with an opportunity

to consider the divergence of animal body shape in nature.^{16,17}

These morphological variations have been of interest in subsequent studies, and the manner of their inheritance and anatomical features were investigated using classical genetic and anatomical methods.^{1,6,7,18–26} However, there are no reports of evodevo research employing molecular developmental approaches, with the exception of our twin-tail goldfish study (Figures 1 and 2).²⁷ Thus, in this review, we first introduce recent progress of studies on the twin-tail goldfish²⁷ and some other goldfish morphological mutations, in comparison with zebrafish mutants.^{1–7,28–30} Secondly, we also consider the strengths/weaknesses and potential of goldfish as a model animal, the differences between zebrafish mutagenesis and the goldfish breeding process, and the relationship between genome duplication and goldfish morphological divergence. Finally, we propose a hypothesis and discuss future perspectives on the relationship between genetic variation and

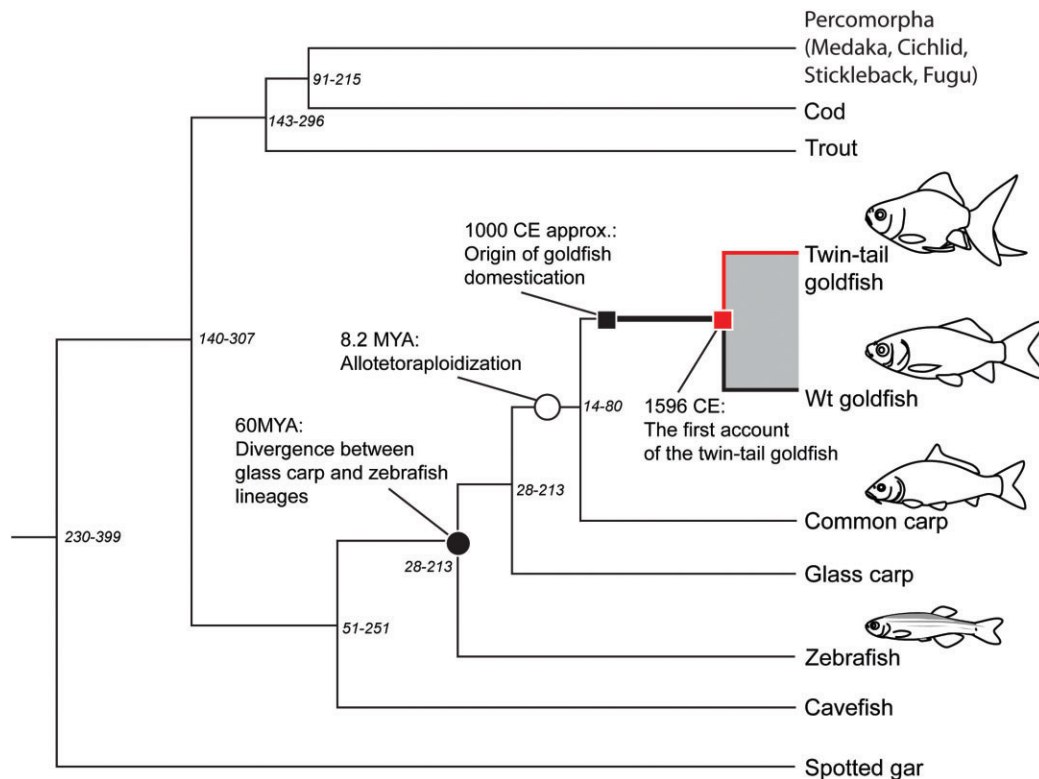

FIGURE 2 | Phylogenetic relationships between goldfish, common carp, and 10 representative ray fin fish species in which whole genome sequences are available are described based on Refs 10–13; Fugu, Cichlid, Medaka, and Stickleback are collectively grouped as Percomorpha. Evolutionary events and their dating in the lineages of goldfish, common carp, and zebrafish are based on Refs 8, 10–12, and 14 (circles and squares). CE and MYA indicate Common Era and million years ago, respectively. The branch lengths were drawn arbitrarily and do not reflect evolutionary time. Previously reported divergence times (MYA) of each node are indicated in italics.¹⁵

developmental mechanisms in goldfish morphological evolution.

TWIN-TAIL GOLDFISH AND ITS GENETIC BACKGROUND

Twin-tail morphology was previously described at the anatomical and embryological levels (Figure 3).^{23,25,26} Genetic analyses of this morphological trait were performed by two researchers.^{1,22} However, this morphological feature was not revisited by researchers in the field of molecular developmental genetics until its responsible gene was recently identified.²⁷ In this section, we explain the anatomical features of twin-tail morphology and its significance in evodevo studies, and discuss the relationship between such goldfish morphology and *dino/chordin* zebrafish mutants.

Axial Skeletal Morphology in Twin-Tail Goldfish

The detailed skeletal anatomy of the bifurcated caudal and anal fins, their developmental process, and variations of the bifurcated caudal skeletons in terms of their number of elements were first described by Watase²³ (Figures 1(b)–(i) and 3); he indicated that not only caudal and anal fin rays, but also their attaching endo-skeletons, are bifurcated in the twin-tail goldfish strains.²³ Subsequently, his paper was introduced by William Bateson¹⁷ as an example of a naturally occurring variation.

In the early 1900s, Matsui conducted a large-scale genetic analysis.^{1,6} He made hybrid strains between morphologically divergent goldfish parents and analyzed the morphological features of the subsequent generations, focusing not only on the twin-tail, but also other morphological traits (dorsal fin, eyes, etc.)^{1,6,7}; in fact, he described the morphological features and their modes of inheritance in great detail. However, it appears that he was unable to interpret the mode of inheritance of the twin-tail, presumably due to its complexity. Based on Matsui's data, Smartt² claimed that the mode of inheritance can be explained using one locus model with incomplete penetrance. However, this proposal has not been tested. We effectively had no understanding of the mode of inheritance of the twin-tail goldfish phenotype at the level of molecular biology until 2014, when the *chordin* gene was identified as the one of the genes essential for the twin-tail goldfish phenotype.²⁷

Dino/Chordin Mutant Zebrafish and Twin-Tail Goldfish

Chordin genes act as a dorsal organizer in the dorsal–ventral (DV) patterning of early embryogenesis (Figure 4(a)).^{31–42} Zebrafish with a mutation in this gene are known as *dino/chordin* mutants (Figure 5).^{37,38} The *dino* mutant, in which the region encoding functional domains (cysteine-rich domains) is completely lost from the *chordin* gene, has been investigated by several researchers in the context of early axis patterning and skeletal development in zebrafish (Figure 5).^{37–41} In one such study, Fisher and Halpern³⁹ showed that *dino* adult individuals exhibit variations in axial skeletal morphology. More significantly, their study indicated that some *dino* mutants exhibit bifurcated caudal skeletons.

Focusing on this phenotypic similarity between *dino* and the twin-tail goldfish, Abe et al.²⁷ performed backcross and functional analyses of goldfish (Figures 6 and 7). From the analyses, they learned that the goldfish has two *chordin* gene paralogues (designated as *chdA* and *chdB*), and that *chdA* of twin-tail goldfish strains has a stop codon (X) in a coding region; the wild-type (WT) and mutated *chdA* alleles were named *chdA^{wt}* and *chdA^{E127X}*, respectively (Figure 5(a)). From the position of the stop codon, it is predicted that three of four cysteine-rich domains will be absent from the encoded protein, thereby reducing the function of the *chdA* gene (Figure 5(b)).^{27,42} In fact, it was demonstrated that twin-tail goldfish larvae with a *dino*-like phenotype (duplicated fin fold and ventralized embryonic features) are homozygous for the *chdA* alleles carrying the premature stop codon (Figure 5(b)). It was also shown that injection of *chdA^{wt}* mRNA could rescue the bifurcated caudal fin phenotype, while injection of *chdA^{E127X}* mRNA could not, suggesting that *chdA* is responsible for the twin-tail phenotype (Figure 7).²⁷ As the *chdA^{E127X}* allele is homozygous in all of the twin-tail goldfish strains examined in this study, it is predicted that this allele was fixed in the common ancestor of the twin-tail goldfish strains.²⁷ Moreover, analyses of the gene expression patterns indicated that DV-patterning in the twin-tail goldfish embryos is altered by the stop codon mutation in *chdA^{E127X}*; goldfish embryos exhibited a ventralized phenotype (Figure 8).

The above work suggests that the *chdA^{E127X}* allele is essential for the twin-tail goldfish phenotype. However, this study also identified two exceptional goldfish individuals which were homozygous for the *chdA^{E127X}* allele, but did not exhibit twin-tail phenotypes (Figure 6).²⁷ At the genetic level, this type of phenotype can be explained by one of the following

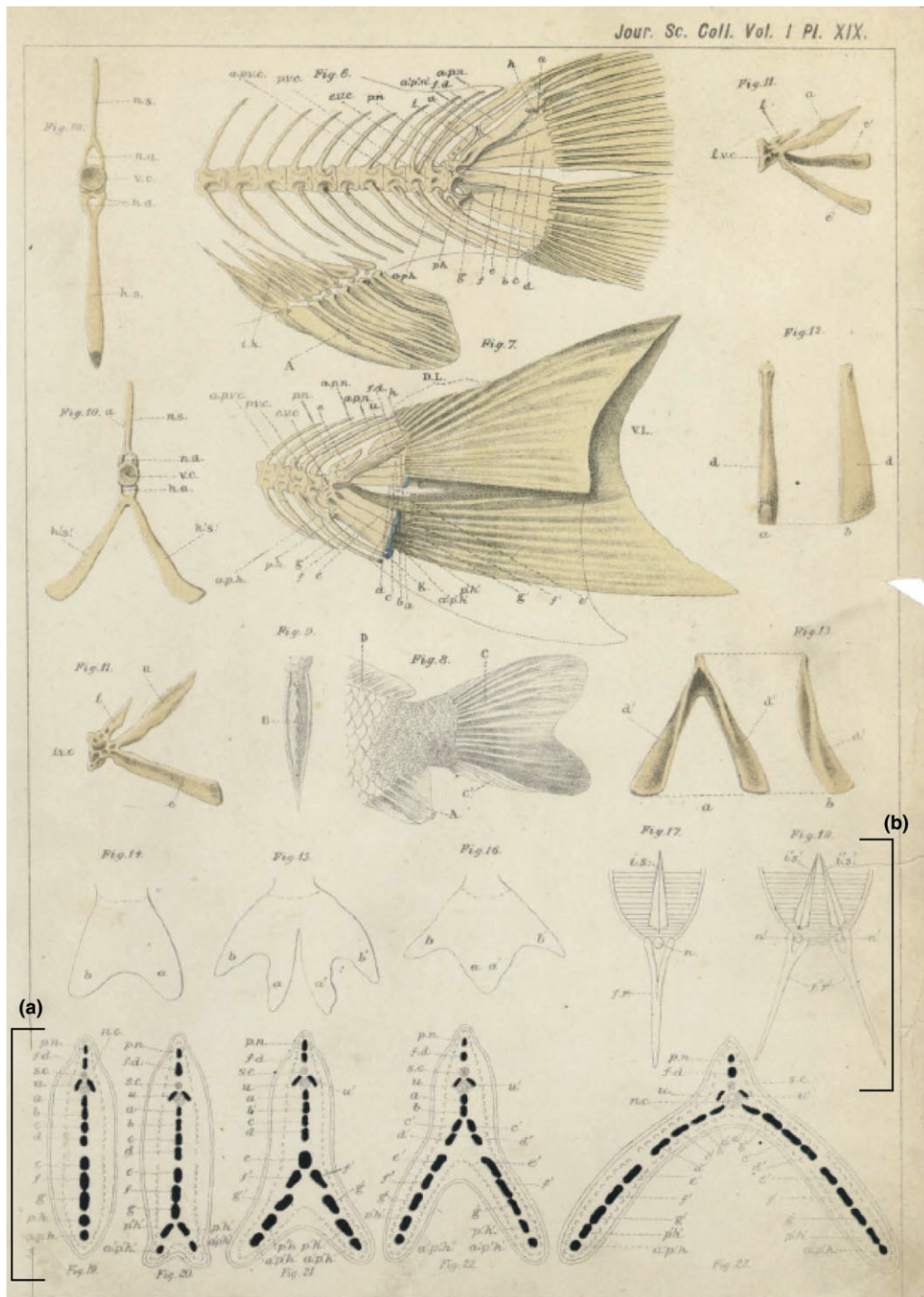

FIGURE 3 | Anatomy of the caudal skeleton of twin-tail goldfish as described by Watase.²³ (a) Drawings of transverse sections at the caudal level in different goldfish specimens with variations in twin-tail morphology. Black colored ovals indicate skeletal elements. (b) Drawings of transverse sections at the anal fin level in single (left) and bifurcated anal fin (right) goldfish specimens.

phenomena: (1) multiple responsible loci (including epistasis), (2) variations in penetrance and expressivity, and (3) combination of (1) and (2) (they are not mutually exclusive). In fact, it is possible that *chdB*

compensates for the function of *chdA* in the twin-tail goldfish (Figure 4(b); see below). In addition, given that some other DV patterning-related genes (*bmps*, *sizzled*, *tll1*, etc.) regulate (and are regulated by) the

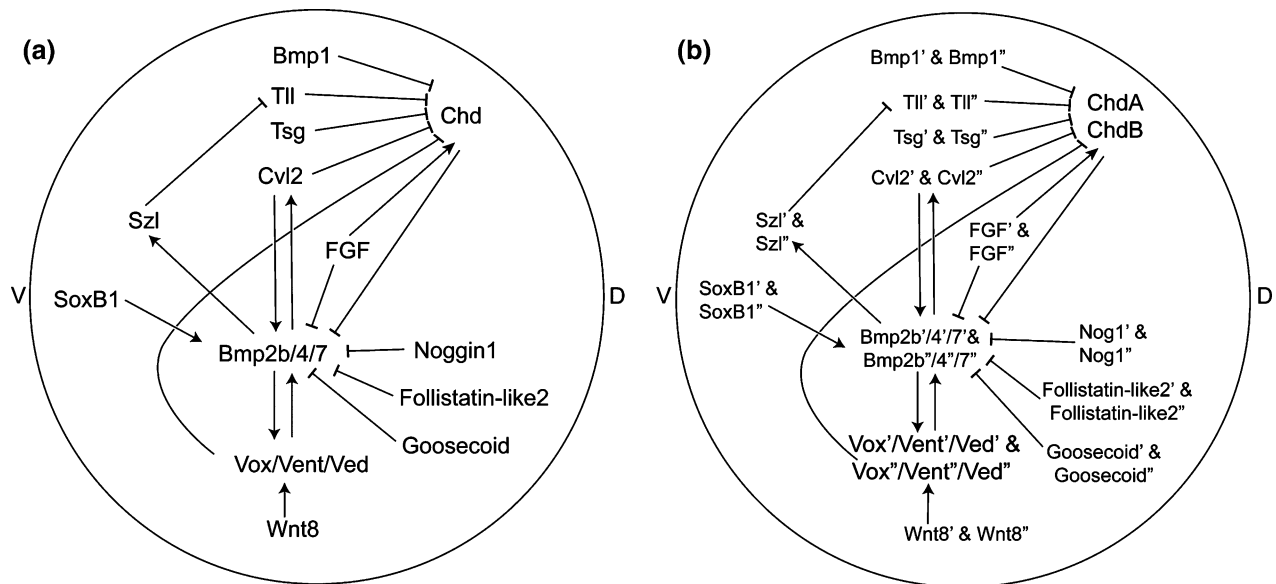

FIGURE 4 | Gene regulatory network of DV-patterning-related genes. (a) Zebrafish DV-patterning-related genes and their regulatory relationship. (Reprinted with permission from Ref 31. Copyright 2011 Annual Review) (b) Hypothetical goldfish DV-patterning-related genes. Hypothetical paralogous genes are indicated by single (') and double (") primes.



FIGURE 5 | Zebrafish and goldfish *chordin* genes. (a) Schematic representation of the Chordin amino acid sequences of zebrafish and goldfish. Colored boxes indicate cysteine-rich domains. Arrowheads indicate the mutated sites. (b) Chordin gene alleles possessed by zebrafish *dino* mutants and twin-tail goldfish strains.

chordin gene,^{31–34,40,41} their polymorphisms may affect the penetrance and expressivity of the *chdA*^{E127X} allele (Figure 4(b)). More significantly, taking into account reports that these DV patterning-related genes form a robust feedback loop system,^{31,32,34–36,40,41} the system may cancel out the effects of the *chdA*^{E127X} allele. In the above cases, it is unclear whether simple genetic approaches [linkage mapping, quantitative trait loci (QTL), etc.] would be sufficient to identify additional genes responsible for the twin-tail phenotypes.

Contribution of Subfunctionalization toward Ensuring Both Survival and Attractive Morphology

The survival rates of twin-tail goldfish and the *dino* zebrafish mutant are clearly different from each other.^{27,39} The survival rate of *dino* zebrafish is less than 10%³⁹; most *dino* zebrafish larvae exhibit malformation of the swim bladder, resulting in high mortality.³⁹ However, twin-tail goldfish larvae do not show such high mortality. Indeed, the survival rates

of backcross progenies are greater for mutated individuals (83.5%) than WT individuals (76%).²⁷ We offer three possible explanations to account for such a high survival rate in twin-tail goldfish: (1) the duplicated *chdB* gene compensates for the function of the mutated *chdA* gene; (2) the remaining cysteine-rich domain in *chdA*^{E127X} retains part of the function of the original *chdA* gene; and/or (3) some other loci and/or alleles that have deleterious effects when

present with *chdA*^{E127X} were eliminated by selective pressure. One of these, or the combined effect of multiple possibilities, may have improved the survival rate of twin-tail goldfish during the domestication process. Of these possibilities, the first appears to be most probable, because of the almost the identical molecular function and sub-functionalized gene expression patterns of *chdA* and *chdB*, as discussed below.

As duplicated paralogous genes have been previously indicated to be important for evolution,^{43–46} the *chdB* gene may play a substantial role in the formation of the morphological features specific to

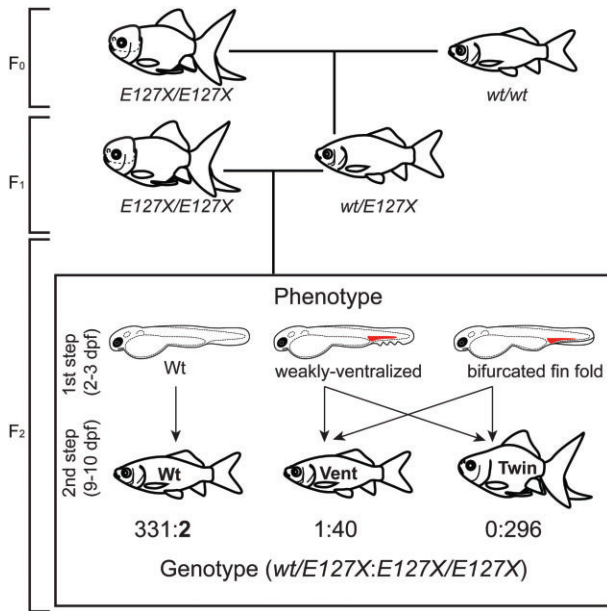

FIGURE 6 | Schematic representation of backcross analysis of the twin-tail phenotypes. The number in bold indicates the number of exceptional wildtype individuals (*E127X/E127X*), suggesting low penetrance. (Reprinted with permission from Ref 27. Copyright 2014).

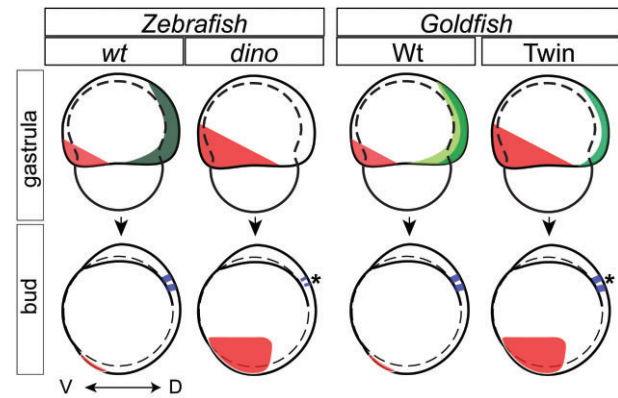

FIGURE 8 | Schematic representation of gene expression patterns in wild-type and *dino* zebrafish, and wild-type and twin-tail goldfish strains. Olive, light green, green, red, and blue regions represent areas positive for zebrafish *chordin*, *chdA*^{wt}, *chdB*, ventral markers (*eve1*, *sizzled*, and *bmp4*), and *krox20*, respectively. Asterisks indicate areas of *krox20* expression in twin-tail goldfish and *dino* zebrafish. (Reprinted with permission from Ref 27. Copyright 2014).

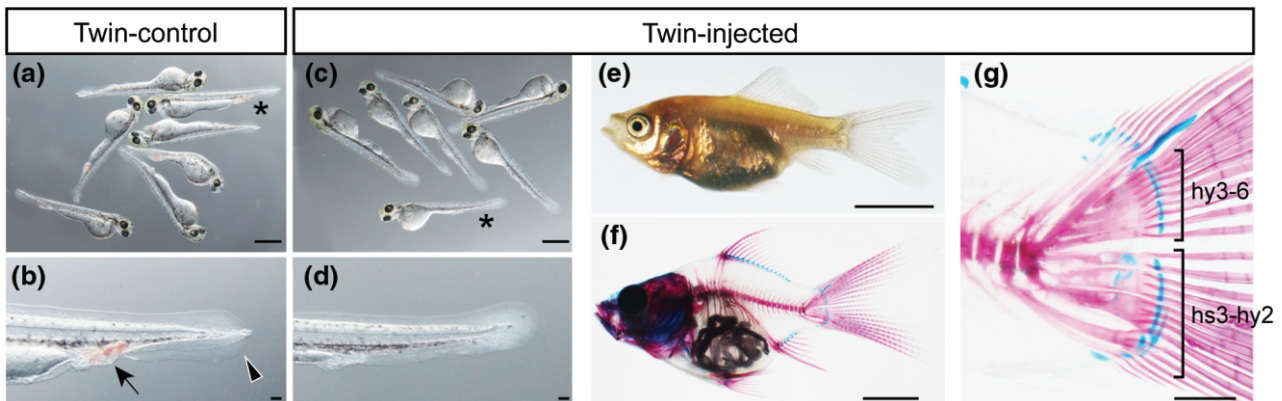

FIGURE 7 | Rescue phenotype of twin-tail goldfish. (a, b) Control twin-tail goldfish larval individuals. (c–g) Twin-tail goldfish individuals injected at the one-cell zygote stage with *chdA*^{wt} mRNA. The magnified views of caudal regions in (b) and (d) correspond to the asterisked specimens in (a) and (c), respectively. (e) Lateral view of juvenile. (f) Alcian blue- and alizarin red-stained specimen. (g) Magnified view of the caudal region of (f). Scale bars: 5mm (e, f), 1 mm (a, c, g), 100 μm (b, d). (Reprinted with permission from Ref 27. Copyright 2014 Nature Publishing Group).

twin-tail goldfish embryos. In fact, *chdA* and *chdB* exhibit similar functions, at least at the coding region.²⁷ As such, one may assume that the potential lethal effects resulting from the absence of *chdA*^{wt} are rescued by the presence of *chdB*. However, this explanation cannot be accepted directly, as it raises a further question: why does the *chdB* gene not completely cancel out the twin-tail phenotype? In other words, if *chdA* and *chdB* have identical functions, the stop codon mutation in *chdA*^{E127X} may not exert any significant effects on the embryonic features, preventing the formation of twin-tail morphology in the adult. The answer to this question is in their partly (not completely) overlapping expression patterns. In fact, their expression patterns diverge at the gastrula stage; *chdB* displays narrow band-like expression patterns at the dorsal side of the embryos, while *chdA* shows broader expression patterns around the blastoderm margin area (Figure 8). These different expression patterns suggest that *chdA* and *chdB* play different roles in goldfish embryos. Combined with the observation that the blastoderm margin ultimately moves toward the posterior region to form the tail bud at the bud stage, it appears that the absence or presence of *chdA*^{wt} may affect the development of the tail region. Moreover, the finding that *chdB* is expressed in the dorsal region of twin-tail goldfish at the bud stage suggests this gene has a significant role at this region.

There are important differences in dorsal tissue development between *dino* zebrafish and twin-tail goldfish, including the observation that the size of the hindbrain was reduced in the *dino* mutant as compared with that of WT; such evident hindbrain reduction could not be observed in twin-tail goldfish (Figure 8). Such differences suggest that the presence of subfunctionalized *chdB* expression patterns is required to prevent excessive reduction of the hindbrain, which may affect the survival rate of twin-tail goldfish embryos.

The subfunctionalized gene expression patterns of *chdA* and *chdB* allow us to explain the process by which goldfish with twin-tail morphology can exhibit a high survival rate. The *chdA* and *chdB* expression patterns also led us to suggest that subfunctionalized gene expression patterns are derived from the divergence of cis-regulatory element(s) or trans factor(s) [including coding and noncoding region(s) of trans factor(s)]. However, it is unclear whether genome duplication and subfunctionalization provide a sufficiently reasonable explanation for how highly robust developmental mechanisms were modified to generate twin-tail morphology in the goldfish lineage.

REPRESENTATIVE MORPHOLOGICAL MUTATIONS IN ORNAMENTAL GOLDFISH

Although the gene responsible for twin-tail goldfish was previously identified by us as the *chdA* gene through the application of molecular developmental genetic techniques and knowledge,^{27,30} other morphological mutations have not been investigated at the level of molecular developmental genetics. Morphological variations of the goldfish have been well-described in various textbooks.^{2–4} For example, 23 different goldfish strains were previously described in terms of their genealogical relationships⁷ (Figure 1(j)). In addition, Smartt² categorized modern goldfish variations into 16 groups, as follows: Common goldfish, *Comet*, *Shubunkin*, *Wakin*, *Jikin*, *Fantail*, *Ryukin*, *Tosakin*, *Veiltail*, *Telescope*, *Celestial*, *Bubble-eye*, *Pon-pon*, *Perlscale*, *Oranda*, and *Ranchu-Lionhead* Group.² As can be inferred from the above examples, there is no clear consensus on how diverged goldfish strains should be categorized and designated. The major reason for the lack of a systematic nomenclature system for goldfish varieties is that all goldfish strains, even those with highly diverged appearances, can mate with any other strain, and give rise to viable offspring, thereby resulting in new strains which cannot be categorized by the previous criteria. As external morphology and coloration are major factors with which breeders categorize goldfish strains, newly established strains were arbitrary designated by breeders, without detailed consideration of their anatomical, developmental, and molecular genetic background.

In this section, we introduce certain morphological mutations of genetically fixed ornamental goldfish strains, with consideration given to their anatomical features (Table 1). We first divide the goldfish body into cranial and postcranial parts along the anterior to posterior body axis, in a similar manner to other vertebrate species.^{47,48} In addition, mutated morphological features in postcranial regions were also further subdivided into three types^{47,48}; mutations at trunk, median fins, and scale (Table 1). Moreover, we provide some descriptions of hypothetical candidate genes responsible for these morphological mutations, taking into account the presumably equivalent zebrafish mutant strains and the developmental processes that cause these morphological mutations (see below).

Mutations at the Cranial Level

The ‘hood’ or warty growth (epidermal thickening in cranial and opercula regions), *narial bouquets* or

TABLE 1 | Representative Mutant Morphological Features in Goldfish

Mutated Locations	Name of Phenotype ¹	Representative Goldfish Strains	
Cranial level	<i>Hood or warty growth</i>	<i>Oranda-shishi-gashira, Ranchu</i>	
	<i>Narial bouquets</i>	<i>Osaka-ranchu, Hanafusa</i>	
	<i>Water bubble eyes</i>	<i>Water bubble eyes strain (Suihougan)</i>	
	<i>Protuberant eyes</i>	<i>Telescope-eye (Demekin)</i>	
	<i>Upwardly directed protuberant eyes</i>	<i>Celestial (Chotengan)</i>	
Postcranial level			
	Trunk	<i>Globular shape of body</i>	<i>Ryukin, Ranchu</i>
	Median fins	<i>Twin-tail</i>	<i>Ryukin, Oranda-shishi-gashira, Ranchu</i>
		<i>Caudal fin less</i>	<i>Meteor</i>
		<i>Twin-anal fin</i>	<i>Ryukin, Oranda-shishi-gashira, Ranchu</i>
		<i>Long fin</i>	<i>Commet</i>
		<i>Dorsal-fin less</i>	<i>Ranchu, Chotengan</i>
	Scale	<i>Dormed scale</i>	<i>Pearlscale</i>

¹ Please see main text and Ref 2.

pon-pon (growth of epidermal tissues around the nostril), *water bubble eyes* (developed infraorbital vesicle), *telescope-eye* (protuberant eyes), and *upwardly directed protuberant eyes* mutations can be considered to be mutations at the cranial level (Table 1).² Of those mutations, the *hood*, *protuberant eyes*, and *upwardly directed protuberant eyes* mutations involve alterations of skeletal morphology.^{25,49} Moreover, the inheritance manner of *protuberant eyes* is Mendelian, as shown by genetic approaches.⁷ Although the molecular genetic background of this eye mutation in goldfish is still unknown, the adult morphology of the *silvalfdv* zebrafish mutant, in which tumors grow from the eyes, implies that this locus and/or its related locus may be responsible for the goldfish eye mutations.^{29,50}

Mutations in the Postcranium Region

Trunk Level

Globular body shape is a representative mutation of the mid trunk region, and can be observed in various different goldfish strains (Figure 1(c)–(i) and Table 1). Moreover, this morphological mutation can be further subcategorized into several different levels, including curved back, straighter back, and short- and medium globular.² Goldfish strains with globular shapes are also known to have reduced numbers of vertebrae.²⁶ In addition, the number of vertebrae varies among different mutant strains. For example, Ryukin and Ranchu are both twin-tail ornamental goldfish strains, but these strains differ in

their total number of vertebrae, with 25–29 and 19–23, respectively.²⁶ This reduction in the number of vertebrate arises from disruption of metameric patterns and/or the reduction of vertebrae, neural, and hermal spines.²⁵

Based on the observations that (1) twin-tail goldfish have mutations in one of the two recently duplicated *chordin* genes, (2) *dino/chordin* mutants exhibit malformation of axial skeletal elements,^{27,39} and (3) *chordin* gene expression affects the ossification process,⁵¹ it is predicted that all of ornamental goldfish with the twin-tail phenotype possess a certain level of disorganization of skeletal development. With the exception of the *chdA* gene,²⁷ no other gene has yet been discovered to affect axial skeletal morphology. However, the finding that the *fsstbx24* zebrafish mutant exhibits malformation of axial skeletal elements^{29,52,53} suggests that somitogenesis related genes may also help determine the number of vertebrae in goldfish.

As regards mid-trunk morphology, it is worth mentioning that the ratio of the size of the anterior and posterior swim bladder differs between WT goldfish and ornamental strains with a globular shape³; the anterior swim bladder is considerably smaller than the posterior swim bladder in goldfish strains with a globular shape.³ This implies that the size and morphology of the Weberian apparatus may also be altered in each skeletal element.⁵⁴

Caudal Fin

Ornamental goldfish variations include twin-tail, long-fin, and caudal finless mutants² (Figure 1(b)–(i)

and Table 1). As mentioned above, twin-tail is one of the representative mutations at the caudal level, and its responsible gene has already been identified as *chordin*.²⁷ It should also be noted that there are variations in caudal fin morphology among twin-tail goldfish strains, and these strains have been subdivided into different categories by breeders (Figure 1(b)–(i)).² For example, the black telescope strains (Figure 1(f)) tend to show well-spread upper and lower lobes of the caudal fin, as compared with the other twin-tail goldfish strains shown in Figure 1(b)–(e) and (g)–(i). Watase also described these variations of the twin-tail, focusing on the skeletal anatomy by indicating how many internal caudal skeletal structures (including hemal spines, hypural, and parhypural) are polymorphic, and which varied among different strains (Figure 3(a)).²³ These differences indicate that there are additionally accumulated mutations which provide variations in not only embryonic, but also postembryonic skeletal morphogenesis. Moreover, it was empirically implied that the water temperature has some effect on twin-tail morphology.² The finding that the *snh*^{ty68} mutation of the *bmp7* gene (a DV patterning gene) in zebrafish is temperature-sensitive⁵⁵ suggests that its homologous genes may be involved in variations of twin-tail morphology in goldfish.

The long-fin goldfish mutation has been fixed as the *Comet* strain and its variations.² These strains have a slender body, and all of the fins, including the median and paired fins, are elongated. At least two different mutant zebrafish strains with elongated fins have been isolated (*lof* and *alf*)²⁹ and so we can compare these mutants with the long-fin goldfish strains. Moreover, while a caudal finless goldfish mutant (*Meteor*) was documented by Smartt 2001, this strain appears to be uncommon among modern goldfish varieties. Caudal finless mutants were also found among zebrafish *dimolchordin* and *sbnlsmad5* mutants,^{39,56,57} suggesting that the same type of mutation may account for both the *Meteor* strain and these zebrafish mutants.

Anal Fin

Watase also observed the exo- and endoskeletal morphology of the anal fin in twin-tail goldfish, and reported that the anal fin and its supporting radials are also bifurcated in some twin-tail goldfish strains (Figure 3(b)).²³ As formation of the bifurcated anal fin requires a bifurcated ventral fin fold, this mutant morphological feature might also require the *chordin* gene mutation. However, the evidence that some twin-tail goldfish do not have bifurcated anal fins suggests that the formation of endo- and exoskeletal

bifurcated anal fin morphology requires not only the *chordin* gene, but also some other additional factors.

Dorsal Fin

It appears that the dorsal-finless mutant was established after twin-tail strains were genetically fixed in the ornamental goldfish population⁵⁸ and this record is consistent with molecular phylogenetic analysis. *Ranchu* and *Chotengan* (*Celestial*) are representative dorsal finless mutant strains, which may have been established during the recent history of goldfish breeding.⁸ Moreover, these strains exhibit dramatic reductions in the number of vertebrae (see above).²⁶ Taking into account the observation that genetic diversity was reduced in domesticated goldfish during their breeding history,⁵⁹ it is expected that the reduction of vertebrae in dorsal-finless mutants is related with reduced genetic diversity in these two strains.

As the expressivity of this morphological mutation is fairly unstable, the inheritance manner of this morphology has not been properly tested.⁷ From the evidence that the *sub* mutant zebrafish exhibits a reduction in the dorsal fin,^{28,29} this zebrafish mutant appears to be comparable to the dorsal finless goldfish mentioned above at the molecular developmental level.

Scale

The *domed scale* mutation is fixed in some goldfish strains, such as the *Pearlscale* strain. Unlike mutations in pigmentation patterns which do not affect scale morphology,¹⁸ this *domed scale* mutation affects the morphology of each scale in the entire body.² Moreover, the similar *mirrorscale* mutation was reported by Smartt,² but this mutation is not common in the goldfish population; this mutation has also been established in common carp population, through mutation of the *fgfr1* gene.⁶⁰ It is expected that further investigation of *fgfr1* and its related genes may reveal why the same mutation is not common in goldfish.

STRENGTHS AND WEAKNESSES OF GOLDFISH AS A MODEL ANIMAL

The above-mentioned variation of goldfish morphology has also made goldfish of particular interest to researchers.^{2–4} Certain other factors have also made goldfish suitable for use as an experimental animal, including its ease of purchase and handling, as well as its viability under artificial aquarium conditions; from the 1990s, increasing numbers of reports have described the use of goldfish for studies of molecular

developmental biology and neuroscience.^{61–82} Additional advantages of goldfish for such studies include its suitable size for manipulation of neural tissues and embryos.^{61,65,72–79,82} However, this animal has not become a model organism for modern molecular developmental biology, partly because of its phylogenetic proximity to zebrafish (Figure 2).^{10,11,30,83}

As zebrafish has become widely used as a model animal in the field of the molecular developmental biology because of the ease of access to its embryos, goldfish embryological studies have gradually faded away.^{84–89} While the large size of goldfish embryos was previously advantageous, this advantage became almost insignificant after manipulation techniques were established in zebrafish.^{70,84} Moreover, goldfish provides no obvious benefits to researchers who are purely interested in molecular developmental genetics, as goldfish require large aquarium systems and long periods of time for maintenance and spawning.⁸³ Indeed, the phylogenetic proximity and embryological similarities of these two teleost species suggest it is unlikely that studies of goldfish would yield discoveries of molecular phenomena that would not be revealed by studies of zebrafish.^{83,90}

For the same reasons mentioned above, goldfish may also not be attractive to researchers in the field of evolutionary biology. For investigating the ancestral state of the fish lineage, medaka is more useful than goldfish, because almost all of the molecular techniques of zebrafish research are also suitable for studies of medaka (Figure 2).^{91–93} As such, comparisons between the phylogenetically distant medaka and zebrafish have provided insights into the common ancestral state of a wide range of teleosts.^{94–96} By the same logic, while comparisons between zebrafish and other model vertebrate animals tend to be recognized as useful,^{97,98} comparisons between the phylogenetically proximate goldfish and zebrafish have not been emphasized by researchers.

Thus, although several neuroscientists continue to use goldfish as a model,^{80,81} there is no precedent for intensive use of goldfish in evodevo studies. In fact, although the significance of investigating Cypriniformes closely related to zebrafish has been emphasized by a few researchers,^{99–101} almost no researchers have specifically indicated the potential of the goldfish morphological variation for evodevo studies.

However, certain other teleost species (e.g., cavefish, sticklebacks, and cichlid species) have recently been used by researchers, despite the fact that these teleost species are disadvantageous when it

comes to the application of molecular developmental genetic techniques, as compared to zebrafish and medaka (Figure 2). These teleost species have been used as models for evodevo studies.^{102–123} Such recent progress has prompted us to reconsider whether the extensive morphological variation of goldfish may also further our understanding in the evodevo field.

In addition to the progress made using these teleost species, studies of the genomic sequences of domesticated birds and mammals also have implications for the use of goldfish. The genomic sequences in domesticated animals (e.g., dog, cat, cow, chicken, and pigeons) have provided several lines of evidence for how physiology, morphology, and color patterns have been influenced by artificial selection.^{124–128} Simultaneously, these studies have motivated us to ask how the developmental mechanisms related to these artificially selected phenotypes evolved.^{129,130} The above-domesticated mammalian and avian species may help answer this question, but animals with both a history of domestication and greater embryological availability (i.e., goldfish) would be preferable. In particular, large numbers of highly transparent embryos (as observed for zebrafish and medaka) would facilitate observations of developmental processes at the molecular level. To determine whether the goldfish is suitable to answer the above question, we examined the domestication process of its morphologically divergent strains and their developmental features.

CONTRAST BETWEEN THE EFFECTS OF MUTAGENESIS AND DOMESTICATION ON MORPHOLOGICAL FEATURES

Similar to how divergent goldfish strains were genetically fixed by human activity, zebrafish mutant strains were also established under artificial conditions. The breeding process exerts selective pressures on several different phenotypic features; e.g., if an individual fish cannot physiologically adapt to the artificially prepared condition in the laboratory or breeder's pond, the individual (whether goldfish or zebrafish) will be eliminated from the breeding population. However, the processes of mutant generation differ in terms of the selective pressure on morphological features (Figure 9). In this part, we contrast zebrafish mutagenesis with goldfish breeding, focusing on morphological features.

Absence of Continuous Directional Selection on a Specific Morphological Trait in Zebrafish Mutant Strains

Zebrafish mutant strains can be considered not to have undergone directional selective pressure of their morphological features, for the following reasons. During initial large-scale mutagenesis (performed to identify genes regulating morphogenesis and development), a wide range of mutated phenotypes may be screened by researchers.^{86,88,89,131–136} At this first step, researchers may carefully screen for any detectable mutated phenotypes which show even subtle differences from WT (Figure 9(a) and (b)).^{88,89,131} In the second part of the process, mutated loci may be subject to genetic isolation or purification. More specifically, researchers will perform backcrosses between the mutant and WT zebrafish individuals to segregate potentially multiple mutated loci. Through this process, mutant zebrafish individuals with double or triple mutated loci may be removed from the zebrafish mutant population, increasing the ease at which researchers can identify the responsible locus or allele for the mutated phenotype.

After the responsible locus and/or allele have been found, the established zebrafish mutant strains tend to be maintained for further detailed molecular, genetic, and developmental analyses.^{28,86,131,137} During maintenance of the mutant strains, it is unlikely that strong directional selection is applied to certain morphological features. For example, a mutated allele which causes high lethality tends to be maintained in heterozygous zebrafish individuals. In this case, the allele cannot be the subject of selection (Figure 9(c) and (d)). Mutants that do not show lethal phenotypes are screened and maintained by using their mild mutated phenotypes as an index. In such cases, the distribution patterns of the phenotypes are not largely affected, although the mutant individuals with low penetrance and expressivity of the phenotypes tend to be removed from the population by researchers (asterisks in Figure 9(b) and (c)). For example, although mutant zebrafish strains with bifurcated fin folds were isolated by mutagenesis,^{28,29} researchers tend not to preferentially select ‘champion’ individuals with the most clearly bifurcated fin fold during the maintenance process. In other words, a certain range of polymorphisms is permitted provided the individuals all possess the required mutated morphology.

More generally, one cannot assume that zebrafish researchers impose strong directional selective pressures, by means of which isolated zebrafish mutant populations would undergo dramatic changes in their distribution patterns and in the mean of their

phenotypic features during the maintenance process (Figure 9(a)–(d)).^{86,88,89,131–136} The experimental mutagenesis process of not only zebrafish, but also of other teleost model systems,^{138–143} can be considered to lack repeated selection for mutations. In this way, it is different from the process of goldfish breeding (Figure 9(e)–(g)) (see below).

Presence of Directional Selection on Goldfish Ornamental Morphology

Unlike the mutated phenotype of zebrafish mutants (Figure 9(a)–(d)), the ornamental morphologies of goldfish have been subject to strong directional selection toward characteristics considered more attractive and valuable for fanciers and breeders (Figure 9(e)–(g)).^{2,5} For example, if one goldfish individual exhibits properties with higher commercial value (such as more symmetric and well-spread bifurcated caudal fins) than other individuals, breeders will use the former (the ‘champion’) as the parent fish to produce the next generation. In other words, for economic reasons, breeders want to exclude polymorphisms which may result in phenotypes with no value from their goldfish population.

In the context of evolutionary biology, the breeding process of goldfish morphological mutant strains can be rephrased as follows: (1) a goldfish individual showing a spontaneous mutated morphological phenotype is selected (Figure 9(f)); (2) the individuals which show the preferred morphological phenotypes are used as parent individuals to produce the next generation (Figure 9(g)); (3) the same process may be performed repeatedly; and (4) finally, the most preferred mutated morphological phenotype is fixed as the established ornamental morphology in the population and unpreferred phenotypes are eliminated, as occurs in nature (Figure 9(h)).¹⁴⁴

The presence of directional selection on goldfish ornamental morphology may allow us to investigate the evolutionary consequence of continuous and directional artificial selection on adult morphological phenotypes. More importantly, the manner by which the developmental process was modified by directional selective pressure on adult morphology can be examined using highly diverged goldfish morphologies, at the levels of both embryology and genetics.

ALLOTETRAPLOIDIZATION AND MORPHOLOGY

By examining the origin of chromosomes, genome duplication can be categorized into two types: autopolyploidization and allotetraploidization.¹⁴⁵ The

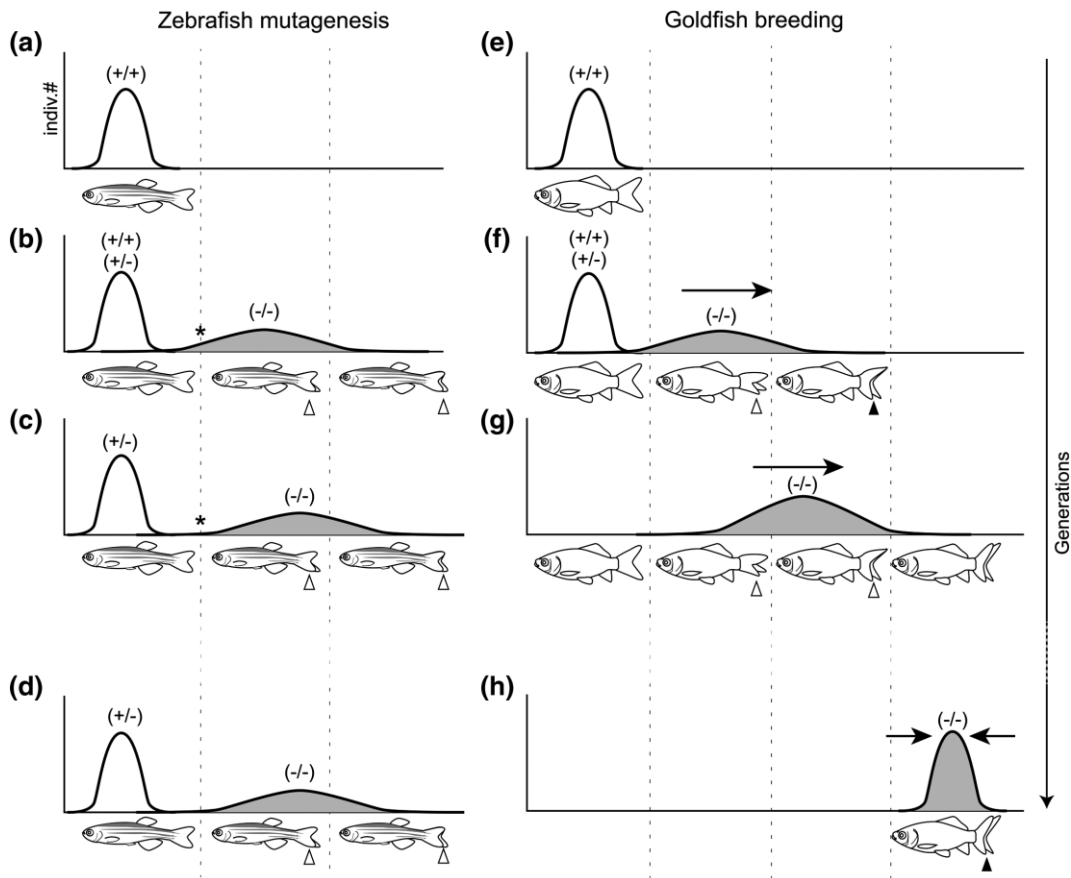

FIGURE 9 | Contrast between zebrafish mutagenesis and goldfish breeding. (a–d) The screening and maintenance process for zebrafish mutants. (e–g) Establishment of goldfish mutant strains. The vertical and horizontal axes of each graph indicate the individual number and phenotype of the populations, respectively. (a, e) Wild-type populations show a narrow distribution of the phenotype. (b, f) Distribution patterns of the wild-type, heterozygous, and mutant homozygous population in early generations. Arrowheads indicate mutated phenotypes. Black arrowheads indicate the most preferred mutated phenotypes for breeders. Horizontal arrows indicate selective pressures. This scheme is described under the assumptions that the + allele is dominant to the – allele, (+/+) and (+/–) populations show narrow and identical distributions, and the population consisting of –/– individuals shows a polymorphic phenotype. (c, g) The distribution patterns after screening. The screening of homozygous mutants with morphological features tends to remove individuals with low penetrance of the phenotype (asterisks in b and c). (d, g) The distribution patterns after long-term repeated selections. (d) The distribution patterns of the zebrafish mutant populations tend to show the same distribution patterns with former generations (c). (g) During goldfish breeding, the most preferred mutated traits in each generation (black arrowheads in g and h) tend to be selected and finally fixed in the population. If the morphological feature in question has high commercial value, stabilizing selection makes the distribution pattern narrow.

former refers to genome doubling in the same species, while the latter is duplication of the genome through species hybridization. Allotetraploidization has been found to have occurred in a number of plant species and in a limited number of animal species (e.g., amphibian species).^{146–153} A recent genome project involving various common carp strains revealed that its genome duplication event is a case of allotetraploidization, as apparent from the clear two-to-one orthologous relationship between zebrafish and common carp.¹⁵⁴ Although whole genome sequences are not yet available for goldfish as they are for common carp, the phylogenetic and cytogenetic proximity of

these two teleost species suggests that allotetraploidization occurred in the common ancestor of these teleost species (Figure 2).^{10,155,156}

How did allotetraploidization contribute to goldfish morphological evolution? A conventional answer to this question is that the expression patterns of the subfunctionalized or neo-functionalized genes were modified,⁴⁴ enabling divergence of goldfish morphological features, such as fins, eyes, and body shape. Such arguments are contained in a number of papers dealing with vertebrate genome evolution.^{157–159} In fact, the mirror carp phenotype and duplicated *fgfr* genes were explained using the

above framework.¹¹⁴ Moreover, this explanation would account for the bifurcation of the axial skeletal system through the modification of DV patterning-related genes (Figure 4). However, such an interpretation raises further questions, as follows. Why is morphological diversity observed in the goldfish lineage, but not in that of common carp? Is it possible to generate ‘twin-tail’ common carp if we subject WT common carp to mutagenesis and selective pressure? Is the appearance of the twin-tail morphology truly related to allotetraploidization? More generally, it appears that the relationship between allotetraploidy and morphological evolution has not been considered in depth in vertebrate species.

Abundant examples of allotetraploid species have enabled the relationship between morphological divergence and allotetraploidy to be well investigated at the molecular level in plants.^{45,46,149–152} Adams and colleagues^{150–152} analyzed gene expression patterns of duplicated genes that arose from allotetraploidization (paralogous or homologous genes) in different tissues, and proposed that the duplicated genes were silenced by epigenetic factor(s).^{150,151} The phylogenetic divergence of plants and animals make it difficult to directly compare allotetraploidization between these organisms. However, it may be worth investigating whether the same kind of event occurred in the common ancestor of goldfish and common carp, focusing on epigenetic factors and allotetraploidization. It is expected that further comparative studies between allotetraploidized species of plants and animals will provide clues to answer the above questions.

INCREASED MORPHOLOGICAL DIVERSITY WITH REDUCED GENETIC VARIATION

The variation of goldfish strains has been described in genetic terms by a few researchers (Figure 1). In addition, the number of described strains has increased in the last 100 years (Figure 10).^{2,4} Although differences in the criteria for how goldfish strains are categorized makes it is difficult to compare the number of strains reported by different studies, it is clear that the variety of goldfish strains increased from the 1900s to the 1970s through hybridization of earlier strains.² Curiosity may have driven such efforts to produce new strains.² Moreover, the ‘standard form’ and ‘specific characteristics’ of certain goldfish strains are defined by local goldfish specialist societies and the organizers of competitive shows.² Therefore, it appears that goldfish

morphological features remain under selective pressure by breeders, thereby giving rise to directional effects that increase morphological variation and/or ornamental attractiveness.

In fact, it is certain that morphologically divergent strains were increased by breeders during the history of goldfish domestication from the middle ages to the early modern period; such an increase also occurred during contemporary history (Figure 10),^{2,7,8} although the precise rate of increase is unknown. Simultaneously, the goldfish population experienced several bottleneck events or founder effects. In fact, taking into account the finding that *chdA*^{E127X} alleles are homozygous in all of the investigated twin-tail goldfish strains,²⁷ it is assumed that most of the morphologically divergent goldfish strains were derived from a limited number of ancestors. This assumption is consistent with the molecular population genetic analysis, which suggested that haplotype diversity decreased during the domestication process.⁵⁹ However, this raises a question: how did goldfish breeders succeed in generating so many morphologically divergent goldfish strains from a low variety of genetic polymorphisms (Figure 1)?

The first type of answer to the above question is based on the idea that a certain level of genetic polymorphisms was maintained to enable morphological variations in goldfish populations, even after the bottleneck and founder effects (Figure 11(a) and (b)). For example, genetic polymorphisms were increased by hybridization between different goldfish or wild *Carassius auratus* populations and/or newly occurred mutations, which contributed to the morphological changes (Figures 1(j) and 11(a)). In fact, several variations of goldfish appear to have been established by hybridization between different goldfish strains, according to historical descriptions (Figure 1(j)).^{2,4,7,8} Furthermore, on the basis that

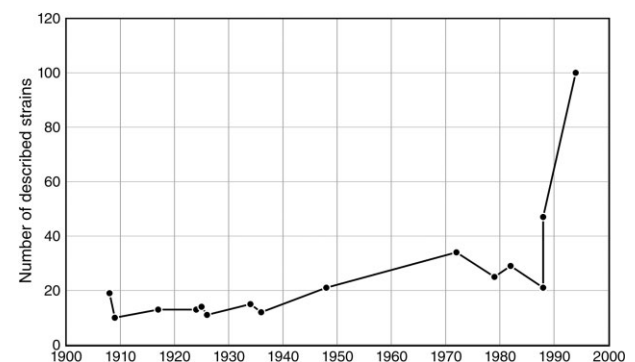

FIGURE 10 | Increase in described goldfish strains from the early to late 20th century. The number of strains is based on the study by Smartt.²

allotetraploidization occurred in the lineage of common carp/goldfish (Figure 2), it is expected that some of the resulting paralogous genes may behave as different alleles of the same gene, implying that certain levels of genetic polymorphisms can be maintained even after inbreeding (Figure 11(b)).

The second type of answer is based on the reduction of developmental robustness (Figure 11(c) and (d)). It is known that some mutated phenotypes derived from genetic polymorphisms (or sometimes environmental factors) can be masked by developmental robustness (or the ‘capacitor’), but are exposed should such robustness decrease (Figure 11(c)).^{161–163} Hsp90 of *Drosophila* and cavefish are well known examples.^{114,160} Moreover, gene regulatory network systems themselves are known to act as capacitors.^{161,162} Given that the *chordin*-related dorsal ventral patterning molecular network has the properties of a capacitor (Figure 4), it is possible that a reduction of the robustness of the DV patterning mechanism caused by the stop codon mutation exposes morphological variations (including twin-tail morphology) (Figures 4 and 5).²⁷

The two possible explanations above are not mutually exclusive. It is reasonable to assume that both of these evolutionary events occurred during goldfish domestication. Hence, these evolutionary scenarios should be considered together. For example, genetic variations may have initially increased by allotetraploidization, which may have been followed by a near simultaneous reduction of genetic polymorphisms and developmental robustness. In this case, there is a possibility that the remaining genetic

polymorphisms will be exposed and detected as various different phenotypes (Figure 11(d)). Alternatively, after a significant reduction of genetic polymorphisms and developmental robustness, the level of genetic polymorphisms may have been restored by hybridization between different goldfish populations, which is empirically performed by breeders to avoid inbreeding depression (Figure 11(e)). Moreover, it is also assumed that the two evolutionary processes mentioned above occurred multiple times. Establishment of a plausible evolutionary scenario for goldfish morphological diversity will require further studies, employing a combinational approach based on principles relating to genomics and developmental biology (see below).

COMBINATIONAL APPROACHES TOWARD WHOLE GENOME- AND HIGH-RESOLUTION ONTOGENETIC ANALYSES

In light of the evidence that certain domesticated animals have undergone the aforementioned evolutionary process (increasing genetic polymorphisms and reducing developmental processes), morphologically varied goldfish strains may provide novel insights into how phenotypic variations of dogs, cows, pigs, chickens, and pigeons were established.^{124–128} The establishment process of phenotypic variations in those domesticated amniotes was investigated by analyzing whole genome sequences.^{124–128} A reference whole genome sequence is also required to

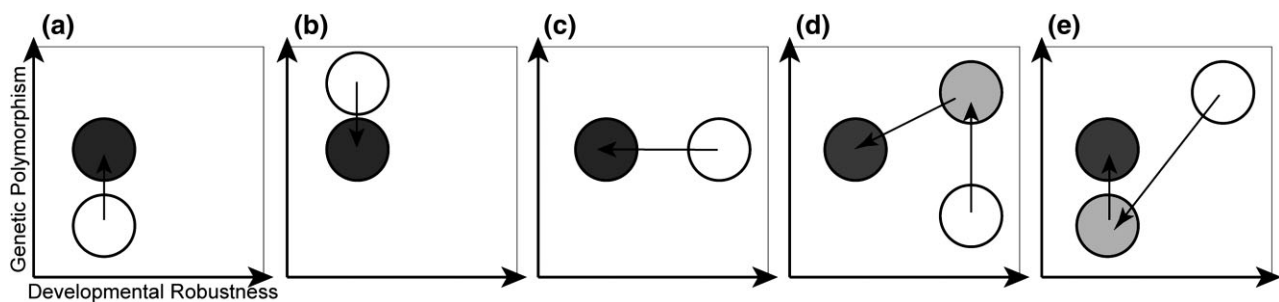

FIGURE 11 | Schematic representation of the relationship between genetic polymorphisms and developmental robustness. Arrows indicate the direction of changes in genetic polymorphisms and developmental robustness. Circles represent the populations [white: before the change; gray: after the change(s)]. (a) Increased genetic polymorphisms under low developmental robustness. This enables polymorphic phenotypes to become the subject of selection. This condition can be generated by additional mutations and/or hybridization between different strains or species. (b) Decreased genetic polymorphisms under low developmental robustness. If the genetic polymorphisms remain, the population depicted as a gray circle can still exhibit polymorphic phenotypes. This condition can be caused by bottlenecks and inbreeding. (c) Reduced robustness while retaining genetic polymorphisms. The genetic polymorphisms can manifest as phenotypic polymorphisms, as observed in the research on Hsp90 of *Drosophila*.¹⁶⁰ (d) Simultaneous reduction of robustness and genetic polymorphisms (light to dark gray circles), preceded by an increase of genetic polymorphisms (white to light gray circles). (e) Increased genetic polymorphisms (light to dark gray circles), preceded by a reduction of robustness and genetic polymorphisms (white to light gray circles).

investigate the divergence process of morphological features of goldfish. Once we obtain the available reference whole genome sequence, it will be relatively easy to identify which loci tend to show high (or low) heterozygosity in various goldfish strains, as previously examined for the above amniotes.^{124–128} In addition, comparisons between goldfish and these domesticated amniote species may provide us with insights into how population size, mating behavior, and generation time reflect morphological evolution. However, it is possible that linkage mapping between genetic markers and adult phenotype based on the whole genome sequence may be insufficient to determine the relationship between genetic polymorphisms and developmental robustness (see also *Twin-Tail Goldfish and Its Genetic Background* section). It is certain that further detailed phenotypic data will also be required.

Fortunately, contrary to the aforementioned ammonites, goldfish has the advantages of embryonic availability and fecundity, also possessed by zebrafish (please see *Strengths and Weaknesses of Goldfish as a Model Animal* section).^{30,83,90} These advantages allow us to examine the ontogenetic process at high resolution, including embryonic, and postembryonic stages,^{83,164} by applying *in vivo* and high-resolution imaging techniques,^{165–168} as well as performing morphometric and ontogenetic analyses.^{169–174} If we can compare different types of morphologically divergent goldfish strains at the levels of both whole genomes and ontogenetic processes, we can derive specific answers to the following questions: are the developmental processes stable or unstable under inbreeding and outbreeding conditions, and are certain developmental stages and morphogenesis stable or unstable under the inbreeding condition? Furthermore, comparative analysis between goldfish morphological variation and mutated phenotypes in medaka and zebrafish will also allow us to identify conserved morphology and robust developmental processes in the teleost lineage (Figure 2). This comparison will provide an opportunity to determine whether artificial selection has affected highly conserved developmental processes in the goldfish lineage. We expect that the goldfish will provide an empirical way to investigate the relationship between phenotypic and genotypic variation through introducing the concept of developmental robustness, rather than relying on simple statistical comparisons between nucleotide substitutions and adult morphology.

Finally, we should mention the significance of the above mentioned combinational approaches for the evodevo field and its relationship with certain

other fields. In fact, the significance of such combinational approaches toward genomics and ontogeny were previously emphasized by Wu and his colleagues.^{175–177} Approaches introduced in their papers (e.g., developmental, ecological, and regulatory dissection of complex traits; so called ‘functional mapping’) are designed to investigate how dynamic traits (including growth rate of animal and plant bodies, tumor size, and viral load in human, among others) connect with QTL.^{175–177} Although their focus appears to be on developing the methodology for using linkage mapping to recognize complex traits as a dynamic system, such methodology will also be of interest to evodevo researchers. For example, it is possible that the loci affecting developmental trajectories which are sought by Wu *et al.* might be related to the genes involved in heterochrony, which, as molecular entities, are relevant to evodevo research^{175–177}; however, the timescale examined by these two research fields is not the same. At the moment, little is known about the time-dependent genetic effects on highly diverged morphological traits in vertebrate species, due to the difficulty of data acquisition. However, it is expected that the above mentioned combinational approaches to goldfish morphological features will allow biologists to reconsider how evodevo-derived concepts (e.g., heterochrony, heterotopy, and developmental constraints) are related to the biological phenomena concerning human disease and crop plants investigated in the fields of genetics and genomics.^{175–180}

CONCLUSION

Although the morphological variations of the goldfish intrigued early biologists, such diversity has not been intensively investigated, presumably because of its perceived lack of use for answering significant biological questions. However, recent genomic studies of domesticated animals prompted us to ask how artificial selection and developmental mechanisms are related. The embryonic availability of goldfish, as well as its phylogenetic-proximity and embryological similarity to zebrafish, mean that it may be one of the most suitable organisms with which to answer the above question. Moreover, the continual selective pressure on the morphological features of goldfish during the breeding process further increases its suitability for answering such questions. In addition, recent genomic analysis of the common carp raised the possibility that goldfish is also allotetraploid. This implies that slightly diverged duplicated genes may have played a crucial role in the morphological

diversification of goldfish lineages. Furthermore, the goldfish may also provide a practical model for consideration of how developmental robustness and genetic diversity are related. Goldfish studies promise

to improve our integrative understanding of the relationships between genome duplication, selective pressure, alterations of the developmental system, and morphological evolution.

ACKNOWLEDGMENTS

We are grateful to the following members of the Marine Research Station, Institute of Cellular and Organismic Biology: Shu-Hua Lee, Ing-Jia Li, Chun-Ju Chang, Hung-Tsai Lee, Jhih-Hao Wei, Chia-Chun Lee, Chih-Chiang Lee, Fei-Chu Chen, and Chi-Fu Hung. We thank Duncan Wright for critical reading of our review. This research was supported by an MST grant 102-2313-B-001-005-MY3 from the Ministry of Science and Technology, Taiwan, and a Career Development Award from Academia Sinica.

REFERENCES

- Matsui Y. Preliminary note on the inheritance of caudal and anal fins in goldfish of Japan. *Proc Imp Acad Tokyo* 1933, 9:655–658.
- Smartt J. *Goldfish Varieties and Genetics: A Handbook for Breeders*. Oxford Malden, MA: Blackwell Science; 2001.
- Hervey GF, Hems J. *The Goldfish*. London: Batchworth Press; 1948.
- Matsui Y. *Pet Library Goldfish Guide: With a Section on Koi*. New York: Pet Library; 1972.
- Matsui Y, Axelrod HR. *Goldfish Guide*. 3rd ed. Neptune City: T.F.H. Publications, Inc; 1991.
- Matsui Y. Genetical studies on gold-fish of Japan. *J Imp Fish Inst* 1934, 30:1–96.
- Matsui Y. *Kagaku to Shumi Kara Mita Kingyo no Kenkyuu*. Tokyo: Seizando Syoten; 1935.
- Chen SC. A history of the domestication and the factors of the varietal formation of the common goldfish, *Carassius auratus*. *Sci Sin* 1956, 6:89–116.
- Hervey GF, Billardon-Sauvigny E. *The Goldfish of China in the XVIII Century*. London: China Society; 1950.
- Saitoh K, Miya M, Inoue JG, Ishiguro NB, Nishida M. Mitochondrial genomics of ostariophysan fishes: perspectives on phylogeny and biogeography. *J Mol Evol* 2003, 56:464–472. doi:10.1007/s00239-002-2417-y.
- Saitoh K, Sado T, Mayden RL, Hanzawa N, Nakamura K, Nishida M, Miya M. Mitogenomic evolution and interrelationships of the Cypriniformes (Actinopterygii: Ostariophysi): the first evidence toward resolution of higher-level relationships of the world's largest freshwater fish clade based on 59 whole mitogenome sequences. *J Mol Evol* 2006, 63:826–841. doi:10.1007/s00239-005-0293-y.
- Wang C, Chen Q, Lu G, Xu J, Yang Q, Li S. Complete mitochondrial genome of the grass carp (*Ctenopharyngodon idella*, Teleostei): insight into its phylogenetic position within Cyprinidae. *Gene* 2008, 424:96–101. doi:10.1016/j.gene.2008.07.011.
- Near TJ, Eytan RI, Dornburg A, Kuhn KL, Moore JA, Davis MP, Wainwright PC, Friedman M, Smith WL. Resolution of ray-finned fish phylogeny and timing of diversification. *Proc Natl Acad Sci USA* 2012, 109:13698–13703. doi:10.1073/pnas.1206625109.
- Wang Y, Lu Y, Zhang Y, Ning Z, Li Y, Zhao Q, Lu H, Huang R, Xia X, Feng Q, et al. The draft genome of the grass carp (*Ctenopharyngodon idellus*) provides insights into its evolution and vegetarian adaptation. *Nat Genet* 2015, 47:625–631. doi:10.1038/ng.3280.
- Hedges SB, Marin J, Suleski M, Paymer M, Kumar S. Tree of life reveals clock-like speciation and diversification. *Mol Biol Evol* 2015, 32:835–845. doi:10.1093/molbev/msv037.
- Darwin C. *The Variation of Animals and Plants under Domestication*. London: John Murray; 1868.
- Bateson W. *Materials for the Study of Variation: Treated with Special regard to Discontinuity in the Origin of Species*. London: Macmillan; 1894.
- Goodrich HB, Nichols R. Scale transplantation in the goldfish *Carassius auratus*. I: effects on chromatophores. II: tissue reactions. *Biol Bull* 1933, 65:253–265.
- Goodrich HB, Trinkaus JP. The differential effect of radiations on mendelian phenotypes of the goldfish, *Carassius auratus*. *Biol Bull* 1939, 77:192–199.
- Kajishima T. Analysis of gene action in the transparent-scaled goldfish, *Carassius auratus*. *Embryologia* 1960, 5:107–126.
- Kajishima T. Genetic and developmental analysis of some new color mutants in the goldfish, *Carassius auratus*. *Genetics* 1977, 86:161–174.
- Berndt W. Vererbungsstudien an Goldfischrasen. *Z Indukt Abstamm Vererbungsl* 1925, 36:161–349.

23. Watase S. On the caudal and anal fins of goldfishes. *J Sci Coll Imp Univ Tokyo* 1887, 1:247–267.
24. Koh T-P. Osteology of *Carassius auratus*. *Sci Rep Natl Tsing Hua Univ* 1931, 1:61–81.
25. Koh T-P. Osteological variations in the axial skeleton of goldfish (*Carassius auratus*). *Sci Rep Natl Tsing Hua Univ* 1932, 2:109–121.
26. Asano H, Kubo Y. Variation of spinal curvature and vertebral number in goldfish. *Jpn J Ichthyol* 1972, 19:223–231.
27. Abe G, Lee S-H, Chang M, Liu S-C, Tsai H-Y, Ota KG. The origin of the bifurcated axial skeletal system in the twin-tail goldfish. *Nat Commun* 2014, 5:3360–3367. doi:10.1038/ncomms4360.
28. vanEeden FJM, Granato M, Schach U, Brand M, FurutaniSeiki M, Haffter P, Hammerschmidt M, Heisenberg CP, Jiang YJ, Kane DA, et al. Genetic analysis of fin formation in the zebrafish, *Danio rerio*. *Development* 1996, 123:255–262.
29. Haffter P, Odenthal J, Mullins MC, Lin S, Farrell MJ, Vogelsang E, Haas F, Brand M, van Eeden FJ, Furutani-Seiki M, et al. Mutations affecting pigmentation and shape of the adult zebrafish. *Dev Genes Evol* 1996, 206:260–276.
30. Bradford Y, Conlin T, Dunn N, Fashena D, Frazer K, Howe DG, Knight J, Mani P, Martin R, Moxon SA, et al. ZFIN: enhancements and updates to the Zebrafish Model Organism Database. *Nucleic Acids Res* 2011, 39:D822–D829. doi:10.1093/nar/gkq1077.
31. Langdon YG, Mullins MC. Maternal and zygotic control of zebrafish dorsoventral axial patterning. *Annu Rev Genet* 2011, 45:357–377. doi:10.1146/annurev-genet-110410-132517.
32. De Robertis EM. Spemann's organizer and the self-regulation of embryonic fields. *Mech Dev* 2009, 126:925–941. doi:10.1016/j.mod.2009.08.004.
33. Sasai Y, Lu B, Steinbeisser H, De Robertis EM. Regulation of neural induction by the Chd and Bmp-4 antagonistic patterning signals in *Xenopus*. *Nature* 1995, 376:333–336.
34. Schier AF, Talbot WS. Molecular genetics of axis formations in zebrafish. *Annu Rev Genet* 2005, 39:561–613. doi:10.1146/annurev.genet.37.110801.143752.
35. Inomata H, Haraguchi T, Sasai Y. Robust stability of the embryonic axial pattern requires a secreted scaffold for Chordin degradation. *Cell* 2008, 134:854–865. doi:10.1016/j.cell.2008.07.008.
36. Inomata H, Shibata T, Haraguchi T, Sasai Y. Scaling of dorsal-ventral patterning by embryo size-dependent degradation of Spemann's organizer signals. *Cell* 2013, 153:1296–1311. doi:10.1016/j.cell.2013.05.004.
37. Hammerschmidt M, Pelegri F, Mullins MC, Kane DA, van Eeden FJ, Granato M, Brand M, Furutani-Seiki M, Haffter P, Heisenberg CP, et al. dino and mercedes, two genes regulating dorsal development in the zebrafish embryo. *Development* 1996, 123:95–102.
38. Schulte-Merker S, Lee KJ, McMahon AP, Hammerschmidt M. The zebrafish organizer requires *chordino*. *Nature* 1997, 387:862–863. doi:10.1038/43092.
39. Fisher S, Halpern ME. Patterning the zebrafish axial skeleton requires early *chordin* function. *Nat Genet* 1999, 23:442–446. doi:10.1038/70557.
40. Muraoka O, Shimizu T, Yabe T, Nojima H, Bae Y-K, Hashimoto H, Hibi M. Sizzled controls dorso-ventral polarity by repressing cleavage of the Chordin protein. *Nat Cell Biol* 2006, 8:329–340. doi:10.1038/ncb1379.
41. Yabe T, Shimizu T, Muraoka O, Bae Y-K, Hirata T, Nojima H, Kawakami A, Hirano T, Hibi M. Ogon/Secreted frizzled functions as a negative feedback regulator of Bmp signaling. *Development* 2003, 130:2705–2716. doi:10.1242/dev.00506.
42. Garcia Abreu J, Coffinier C, Larram J, Oelgeschläger M, De Robertis EM. Chordin-like CR domains and the regulation of evolutionarily conserved extracellular signaling systems. *Gene* 2002, 287:39–47. doi:10.1016/S0378-1119(01)00827-7.
43. Ohno S, Wolf U, Atkin NB. Evolution from fish to mammals by gene duplication. *Hereditas* 1968, 59:169–187.
44. Sémon M, Wolfe KH. Consequences of genome duplication. *Curr Opin Genet Dev* 2007, 17:505–512.
45. Otto SP. The evolutionary consequences of polyploidy. *Cell* 2007, 131:452–462. doi:10.1016/j.cell.2007.10.022.
46. Otto SP, Whitton J. Polyploid incidence and evolution. *Annu Rev Genet* 2000, 34:401–437. doi:10.1146/annurev.genet.34.1.401.
47. Liem KF, Bemis WE, Walker WF, Kabce G. *Functional Anatomy of the Vertebrates: An Evolutionary Perspective*. 3rd ed. Belmont, CA: Brooks Cole; 2001.
48. Kardong KV. *Vertebrates: Comparative Anatomy, Function, Evolution*. 6th ed. Boston, MA and London: McGraw-Hill Higher Education; 2012.
49. Matsui Y. On the warty growths of Japanese lion-head goldfish. *Annot Zool Japon* 1925, 10:355–362.
50. Schonhaler HB, Lampert JM, von Lintig J, Schwarz H, Geisler R, Neuhaus SC. A mutation in the silver gene leads to defects in melanosome biogenesis and alterations in the visual system in the zebrafish mutant fading vision. *Dev Biol* 2005, 284:421–436.
51. Zhang D, Ferguson CM, O'Keefe RJ, Puzas JE, Rosier RN, Reynolds PR. A role for the BMP antagonist chordin in endochondral ossification. *J Bone*

- Miner Res* 2002, 17:293–300. doi:10.1359/jbmr.2002.17.2.293.
52. van Eeden FJ, Granato M, Schach U, Brand M, Furutani-Seiki M, Haffter P, Hammerschmidt M, Heisenberg CP, Jiang YJ, Kane DA, et al. Mutations affecting somite formation and patterning in the zebrafish, *Danio rerio*. *Development* 1996, 123:153–164.
 53. Nikaido M, Kawakami A, Sawada A, Furutani-Seiki M, Takeda H, Araki K. Tbx24, encoding a T-box protein, is mutated in the zebrafish somite-segmentation mutant fused somites. *Nat Genet* 2002, 31:195–199. doi:10.1038/ng899.
 54. Watson JM. The development of the Weberian ossicles and anterior vertebrae in the goldfish. *Proc R Soc Lond B Biol Sci* 1939, 127:452–472.
 55. Dick A, Hild M, Bauer H, Imai Y, Maifeld H, Schier AF, Talbot WS, Bouwmeester T, Hammerschmidt M. Essential role of Bmp7 (snailhouse) and its prodomain in dorsoventral patterning of the zebrafish embryo. *Development* 2000, 127:343–354.
 56. Mullins MC, Hammerschmidt M, Kane DA, Odenthal J, Brand M, van Eeden FJ, Furutani-Seiki M, Granato M, Haffter P, Heisenberg CP, et al. Genes establishing dorsoventral pattern formation in the zebrafish embryo: the ventral specifying genes. *Development* 1996, 123:81–93.
 57. Hild M, Dick A, Rauch GJ, Meier A, Bouwmeester T, Haffter P, Hammerschmidt M. The smad5 mutation somitabun blocks Bmp2b signaling during early dorsoventral patterning of the zebrafish embryo. *Development* 1999, 126:2149–2159.
 58. Komiyama T, Kobayashi H, Tateno Y, Inoko H, Gojobori T, Ikeo K. An evolutionary origin and selection process of goldfish. *Gene* 2009, 430:5–11.
 59. Wang SY, Luo J, Murphy RW, Wu SF, Zhu CL, Gao Y, Zhang YP. Origin of Chinese goldfish and sequential loss of genetic diversity accompanies new breeds. *PLoS ONE* 2013, 8:e59571. doi:10.1371/journal.pone.0059571.
 60. Rohner N, Bercsényi M, Orbán L, Kolanczyk ME, Linke D, Brand M, Nüsslein-Volhard C, Harris MP. Duplication of *fgfr1* permits Fgf signaling to serve as a target for selection during domestication. *Curr Biol* 2009, 19:1642–1647. doi:10.1016/j.cub.2009.07.065.
 61. Yamaha E, Mizuno T, Hasebe Y, Takeda H, Yamazaki F. Dorsal specification in blastoderm at the blastula stage in the goldfish, *Carassius auratus*. *Dev Growth Differ* 1998, 40:267–275. doi:10.1046/j.1440-169X.1998.t01-1-00002.x.
 62. Yamaha E, Mizuno T, Matsushita K, Hasebe Y. Developmental staging in goldfish during the pre-gastula stage. *Nippon Suisan Gakk* 1999, 64:709–717.
 63. Yamaha E, Kazama-Wakabayashi M, Otani S, Fujimoto T, Arai K. Germ-line chimera by lower-part blastoderm transplantation between diploid goldfish and triploid crucian carp. *Genetica* 2001, 111:227–236. doi:10.1023/A:1013780423986.
 64. Yamaha E, Otani S, Minami A, Arai K. Dorso-ventral axis perturbation in goldfish embryos caused by heat and pressure-shock treatments for chromosome set manipulation. *Fish Sci* 2002, 68:313–319. doi:10.1046/j.1444-2906.2002.00427.x.
 65. Yamaha E, Murakami M, Hada K, Otani S, Fujimoto T, Tanaka M, Sakao S, Kimura S, Sato S, Arai K. Recovery of fertility in male hybrids of a cross between goldfish and common carp by transplantation of PGC (Primordial Germ Cell)-containing graft. *Genetica* 2003, 119:121–131. doi:10.1023/A:1026061828744.
 66. Yamaha E, Yamazaki F. Electrically fused-egg induction and its development in the goldfish, *Carassius auratus*. *Int J Dev Biol* 1993, 37:291–298.
 67. Goto-Kazeto R, Abe Y, Masai K, Yamaha E, Adachi S, Yamauchi K. Temperature-dependent sex differentiation in goldfish: establishing the temperature-sensitive period and effect of constant and fluctuating water temperatures. *Aquaculture* 2006, 254:617–624. doi:10.1016/j.aquaculture.2005.10.009.
 68. Tanaka M, Yamaha E, Arai K. Survival capacity of haploid–diploid goldfish chimeras. *J Exp Zool A Comp Exp Biol* 2004, 301A:491–501. doi:10.1002/jez.a.48.
 69. Kusuda S, Teranishi T, Koide N, Nagai T, Arai K, Yamaha E. Pluripotency of cryopreserved blastomeres of the goldfish. *J Exp Zool A Comp Exp Biol* 2004, 301A:131–138. doi:10.1002/jez.a.20017.
 70. Mizuno T, Yamaha E, Yamazaki F. Localized axis determinant in the early cleavage embryo of the goldfish, *Carassius auratus*. *Dev Genes Evol* 1997, 206:389–396. doi:10.1007/s004270050068.
 71. Otani S, Maegawa S, Inoue K, Arai K, Yamaha E. The Germ cell lineage identified by vas-mRNA during the Embryogenesis in Goldfish. *Zool Sci* 2002, 19:519–526. doi:10.2108/zsj.19.519.
 72. Mora-Ferrer C, Neumeier C. Neuropharmacology of vision in goldfish: a review. *Vision Res* 2009, 49:960–969. doi:10.1016/j.visres.2008.08.004.
 73. Schmitz A, Bleckmann H, Mogdans J. Organization of the superficial neuromast system in goldfish, *Carassius auratus*. *J Morphol* 2008, 269:751–761. doi:10.1002/jmor.10621.
 74. Straka H, Beck JC, Pastor AM, Baker R. Morphology and physiology of the cerebellar vestibulolateral lobe pathways linked to oculomotor function in the goldfish. *J Neurophysiol* 2006, 96:1963–1980. doi:10.1152/jn.00334.2006.

75. Zak PP, Ostrovsky MA, Bowmaker JK. Ionochromic properties of long-wave-sensitive cones in the goldfish retina: an electrophysiological and microspectrophotometric study. *Vision Res* 2001, 41:1755–1763. doi:10.1016/S0042-6989(01)00033-5.
76. Salas C, Herrero L, Rodriguez F, Torres B. Tectal codification of eye movements in goldfish studied by electrical microstimulation. *Neuroscience* 1997, 78:271–288. doi:10.1016/S0306-4522(97)83048-5.
77. Saidel WM, Marquez-Houston K, Butler AB. Identification of visual pallial telencephalon in the goldfish, *Carassius auratus*: a combined cytochrome oxidase and electrophysiological study. *Brain Res* 2001, 919:82–93. doi:10.1016/S0006-8993(01)03001-3.
78. Luque MA, Pérez-Pérez MP, Herrero L, Waitzman DM, Torres B. Eye movements evoked by electrical microstimulation of the mesencephalic reticular formation in goldfish. *Neuroscience* 2006, 137:1051–1073. doi:10.1016/j.neuroscience.2005.09.033.
79. Broglio C, Rodríguez F, Gómez A, Arias JL, Salas C. Selective involvement of the goldfish lateral pallium in spatial memory. *Behav Brain Res* 2010, 210:191–201. doi:10.1016/j.bbr.2010.02.031.
80. Zenisek D. Vesicle association and exocytosis at ribbon and extraribbon sites in retinal bipolar cell presynaptic terminals. *Proc Natl Acad Sci USA* 2008, 105:4922–4927. doi:10.1073/pnas.0709067105.
81. Kavalali ET. The mechanisms and functions of spontaneous neurotransmitter release. *Nat Rev Neurosci* 2015, 16:5–16. doi:10.1038/nrn3875.
82. Northcutt RG. Connections of the lateral and medial divisions of the goldfish telencephalic pallium. *J Comp Neurol* 2006, 494:903–943. doi:10.1002/cne.20853.
83. Tsai HY, Chang M, Liu SC, Abe G, Ota KG. Embryonic development of goldfish (*Carassius auratus*): a model for the study of evolutionary change in developmental mechanisms by artificial selection. *Dev Dyn* 2013, 242:1262–1283. doi:10.1002/dvdy.24022.
84. Nusslein-Volhard C, Dahm R. *Zebrafish*. New York: Oxford University Press; 2002.
85. Currie PD. Zebrafish genetics: mutant cornucopia. *Curr Biol* 1996, 6:1548–1552. doi:10.1016/S0960-9822(02)70768-9.
86. Mullins MC, Hammerschmidt M, Haffter P, Nusslein-Volhard C. Large-scale mutagenesis in the zebrafish: in search of genes controlling development in a vertebrate. *Curr Biol* 1994, 4:189–202. doi:10.1016/S0960-9822(00)00048-8.
87. Solnica-Krezel L, Driever W. Microtubule arrays of the zebrafish yolk cell: organization and function during epiboly. *Development* 1994, 120:2443–2455.
88. Haffter P, Granato M, Brand M, Mullins MC, Hammerschmidt M, Kane DA, Odenthal J, van Eeden FJ, Jiang YJ, Heisenberg CP, et al. The identification of genes with unique and essential functions in the development of the zebrafish, *Danio rerio*. *Development* 1996, 123:1–36.
89. Driever W, Solnica-Krezel L, Schier AF, Neuhauss SC, Malicki J, Stemple DL, Stainier DY, Zwartkruis F, Abdelilah S, Rangini Z, et al. A genetic screen for mutations affecting embryogenesis in zebrafish. *Development* 1996, 123:37–46.
90. Kimmel CB, Ballard WW, Kimmel SR, Ullmann B, Schilling TF. Stages of embryonic development of the zebrafish. *Dev Dyn* 1995, 203:253–310.
91. Kawanishi T, Kaneko T, Moriyama Y, Kinoshita M, Yokoi H, Suzuki T, Shimada A, Takeda H. Modular development of the teleost trunk along the dorsoventral axis and *zic1/zic4* as selector genes in the dorsal module. *Development* 2013, 140:1486–1496. doi:10.1242/dev.088567.
92. Takeda H, Shimada A. The art of medaka genetics and genomics: what makes them so unique? *Annu Rev Genet* 2010, 44:217–241. doi:10.1146/annurev-genet-051710-151001.
93. Moriyama Y, Kawanishi T, Nakamura R, Tsukahara T, Sumiyama K, Suster Maximiliano L, Kawakami K, Toyoda A, Fujiyama A, Yasuoka Y, et al. The medaka *zic1/zic4* mutant provides molecular insights into teleost caudal fin evolution. *Curr Biol* 2012, 22:601–607. doi:10.1016/j.cub.2012.01.063.
94. Wittbrodt J, Shima A, Schartl M. Medaka? A model organism from the far east. *Nat Rev Genet* 2002, 3:53–64. doi:10.1038/nrg704.
95. Naruse K, Tanaka M, Mita K, Shima A, Postlethwait J, Mitani H. A medaka gene map: the trace of ancestral vertebrate proto-chromosomes revealed by comparative gene mapping. *Genome Res* 2004, 14:820–828. doi:10.1101/gr.2004004.
96. Kasahara M, Naruse K, Sasaki S, Nakatani Y, Qu W, Ahsan B, Yamada T, Nagayasu Y, Doi K, Kasai Y, et al. The medaka draft genome and insights into vertebrate genome evolution. *Nature* 2007, 447:714–719. doi:10.1038/nature05846.
97. Postlethwait JH, Yan YL, Gates MA, Horne S, Amores A, Brownlie A, Donovan A, Egan ES, Force A, Gong Z, et al. Vertebrate genome evolution and the zebrafish gene map. *Nat Genet* 1998, 18:345–349. doi:10.1038/ng0498-345.
98. Sémon M, Wolfe KH. Reciprocal gene loss between Tetraodon and zebrafish after whole genome duplication in their ancestor. *Trends Genet* 2007, 23:108–112. doi:10.1016/j.tig.2007.01.003.
99. Mabee PM, Arratia G, Coburn M, Haendel M, Hilton EJ, Lundberg JG, Mayden RL, Rios N, Westerfield M. Connecting evolutionary morphology to genomics using ontologies: a case study from Cypriniformes including zebrafish. *J Exp Zool B Mol*

- Dev Evol* 2007, 308:655–668. doi:10.1002/jez.b.21181.
100. Mayden RL, Tang KL, Conway KW, Freyhof J, Chamberlain S, Haskins M, Schneider L, Sudkamp M, Wood RM, Agnew M, et al. Phylogenetic relationships of Danio within the order Cypriniformes: a framework for comparative and evolutionary studies of a model species. *J Exp Zool B Mol Dev Evol* 2007, 308B:642–654. doi:10.1002/jez.b.21175.
 101. Schilling TF, Webb J. Considering the zebrafish in a comparative context. *J Exp Zool B Mol Dev Evol* 2007, 308B:515–522. doi:10.1002/jez.b.21191.
 102. Jeffery WR. Cavefish as a model system in evolutionary developmental biology. *Dev Biol* 2001, 231:1–12. doi:10.1006/dbio.2000.0121.
 103. Jeffery WR. Adaptive evolution of eye degeneration in the Mexican blind cavefish. *J Hered* 2005, 96:185–196. doi:10.1093/jhered/esi028.
 104. Jeffery WR. Regressive evolution in *Astyanax* cavefish. *Annu Rev Genet* 2009, 43:25–47. doi:10.1146/annurev-genet-102108-134216.
 105. Jeffery WR. Pleiotropy and eye degeneration in cavefish. *Heredity* 2010, 105:495–496. doi:10.1038/hdy.2010.7.
 106. Yamamoto Y, Stock DW, Jeffery WR. Hedgehog signalling controls eye degeneration in blind cavefish. *Nature* 2004, 431:844–847. doi:10.1038/nature02864.
 107. Yamamoto Y, Byerly MS, Jackman WR, Jeffery WR. Pleiotropic functions of embryonic sonic hedgehog expression link jaw and taste bud amplification with eye loss during cavefish evolution. *Dev Biol* 2009, 330:200–211. doi:10.1016/j.ydbio.2009.03.003.
 108. Strickler AG, Yamamoto Y, Jeffery WR. The lens controls cell survival in the retina: evidence from the blind cavefish *Astyanax*. *Dev Biol* 2007, 311:512–523. doi:10.1016/j.ydbio.2007.08.050.
 109. Gross JB, Borowsky R, Tabin CJ. A novel role for Mc1r in the parallel evolution of depigmentation in independent populations of the cavefish *Astyanax mexicanus*. *PLoS Genet* 2009, 5:e1000326. doi:10.1371/journal.pgen.1000326.
 110. Yoshizawa M, Gorički Š, Soares D, Jeffery WR. Evolution of a behavioral shift mediated by superficial neuromasts helps cavefish find food in darkness. *Curr Biol* 2010, 20:1631–1636. doi:10.1016/j.cub.2010.07.017.
 111. Yoshizawa M, Jeffery WR, van Netten SM, McHenry MJ. The sensitivity of lateral line receptors and their role in the behavior of Mexican blind cavefish (*Astyanax mexicanus*). *J Exp Biol* 2014, 217:886–895. doi:10.1242/jeb.094599.
 112. Hinaux H, Pottin K, Chalhoub H, Pèrè S, Elipot Y, Legendre L, Rétaux S. A developmental staging table for *Astyanax mexicanus* surface fish and Pachón cavefish. *Zebrafish* 2011, 8:155–165. doi:10.1089/zeb.2011.0713.
 113. Pottin K, Hinaux H, Rétaux S. Restoring eye size in *Astyanax mexicanus* blind cavefish embryos through modulation of the Shh and Fgf8 forebrain organising centres. *Development* 2011, 138:2467–2476. doi:10.1242/dev.054106.
 114. Rohner N, Jarosz DF, Kowalko JE, Yoshizawa M, Jeffery WR, Borowsky RL, Lindquist S, Tabin CJ. Cryptic variation in morphological evolution: HSP90 as a capacitor for loss of eyes in cavefish. *Science* 2013, 342:1372–1375. doi:10.1126/science.1240276.
 115. Albertson RC, Streelman JT, Kocher TD, Yelick PC. Integration and evolution of the cichlid mandible: the molecular basis of alternate feeding strategies. *Proc Natl Acad Sci USA* 2005, 102:16287–16292. doi:10.1073/pnas.0506649102.
 116. Barluenga M, Stölting KN, Salzburger W, Muschick M, Meyer A. Sympatric speciation in Nicaraguan crater lake cichlid fish. *Nature* 2006, 439:719–723. doi:10.1038/nature04325.
 117. Hu Y, Albertson RC. Hedgehog signaling mediates adaptive variation in a dynamic functional system in the cichlid feeding apparatus. *Proc Natl Acad Sci USA* 2014, 111:8530–8534. doi:10.1073/pnas.1323154111.
 118. Cresko WA, Amores A, Wilson C, Murphy J, Currey M, Phillips P, Bell MA, Kimmel CB, Postlethwait JH. Parallel genetic basis for repeated evolution of armor loss in Alaskan threespine stickleback populations. *Proc Natl Acad Sci USA* 2004, 101:6050–6055. doi:10.1073/pnas.0308479101.
 119. Cresko W, McGuigan K, Phillips P, Postlethwait J. Studies of threespine stickleback developmental evolution: progress and promise. *Genetica* 2007, 129:105–126. doi:10.1007/s10709-006-0036-z.
 120. Shapiro MD, Marks ME, Peichel CL, Blackman BK, Nereng KS, Jonsson B, Schluter D, Kingsley DM. Genetic and developmental basis of evolutionary pelvic reduction in threespine sticklebacks. *Nature* 2004, 428:717–723. doi:10.1038/nature02415.
 121. Kimmel CB, Ullmann B, Walker C, Wilson C, Currey M, Phillips PC, Bell MA, Postlethwait JH, Cresko WA. Evolution and development of facial bone morphology in threespine sticklebacks. *Proc Natl Acad Sci USA* 2005, 102:5791–5796. doi:10.1073/pnas.0408533102.
 122. Chan YF, Marks ME, Jones FC, Villarreal G, Shapiro MD, Brady SD, Southwick AM, Absher DM, Grimwood J, Schmutz J, et al. Adaptive evolution of pelvic reduction in sticklebacks by recurrent deletion of a *pitx1* enhancer. *Science* 2010, 327:302–305. doi:10.1126/science.1182213.
 123. Colosimo PF, Hosemann KE, Balabhadra S, Villarreal G, Dickson M, Grimwood J, Schmutz J,

- Myers RM, Schluter D, Kingsley DM. Widespread parallel evolution in sticklebacks by repeated fixation of ectodysplasin alleles. *Science* 2005, 307:1928–1933. doi:10.1126/science.1107239.
124. Lindblad-Toh K, Wade CM, Mikkelsen TS, Karlsson EK, Jaffe DB, Kamal M, Clamp M, Chang JL, Kulbokas EJ 3rd, Zody MC, et al. Genome sequence, comparative analysis and haplotype structure of the domestic dog. *Nature* 2005, 438:803–819. doi:10.1038/nature04338.
125. Wayne RK, Ostrander EA. Lessons learned from the dog genome. *Trends Genet* 2007, 23:557–567. doi:10.1016/j.tig.2007.08.013.
126. Akey JM, Ruhe AL, Akey DT, Wong AK, Connelly CF, Madeoy J, Nicholas TJ, Neff MW. Tracking footprints of artificial selection in the dog genome. *Proc Natl Acad Sci USA* 2010, 107:1160–1165. doi:10.1073/pnas.0909918107.
127. Vonholdt BM, Pollinger JP, Lohmueller KE, Han E, Parker HG, Quignon P, Degenhardt JD, Boyko AR, Earl DA, Auton A, et al. Genome-wide SNP and haplotype analyses reveal a rich history underlying dog domestication. *Nature* 2010, 464:898–902. doi:10.1038/nature08837.
128. Shapiro MD, Kronenberg Z, Li C, Domyan ET, Pan H, Campbell M, Tan H, Huff CD, Hu H, Vickrey AI, et al. Genomic diversity and evolution of the head crest in the rock pigeon. *Science* 2013, 339:1063–1067. doi:10.1126/science.1230422.
129. Morey DF. The early evolution of the domestic dog. *Am Sci* 1994, 82:336–347. doi:10.2307/29775234.
130. Trut L, Oskina I, Kharlamova A. Animal evolution during domestication: the domesticated fox as a model. *Bioessays* 2009, 31:349–360. doi:10.1002/bies.200800070.
131. Amsterdam A, Burgess S, Gollig G, Chen W, Sun Z, Townsend K, Farrington S, Haldi M, Hopkins N. A large-scale insertional mutagenesis screen in zebrafish. *Genes Dev* 1999, 13:2713–2724.
132. Amsterdam A, Nissen RM, Sun Z, Swindell EC, Farrington S, Hopkins N. Identification of 315 genes essential for early zebrafish development. *Proc Natl Acad Sci USA* 2004, 101:12792–12797. doi:10.1073/pnas.0403929101.
133. Gollig G, Amsterdam A, Sun Z, Antonelli M, Maldonado E, Chen W, Burgess S, Haldi M, Artzt K, Farrington S, et al. Insertional mutagenesis in zebrafish rapidly identifies genes essential for early vertebrate development. *Nat Genet* 2002, 31:135–140. doi:10.1038/ng896.
134. Wienholds E, van Eeden F, Kosters M, Mudde J, Plasterk RH, Cuppen E. Efficient target-selected mutagenesis in zebrafish. *Genome Res* 2003, 13:2700–2707. doi:10.1101/gr.1725103.
135. Sivasubbu S, Balciunas D, Davidson AE, Pickart MA, Hermanson SB, Wangensteen KJ, Wolbrink DC, Ekker SC. Gene-breaking transposon mutagenesis reveals an essential role for histone H2afza in zebrafish larval development. *Mech Dev* 2006, 123:513–529. doi:10.1016/j.mod.2006.06.002.
136. Nagayoshi S, Hayashi E, Abe G, Osato N, Asakawa K, Urasaki A, Horikawa K, Ikeo K, Takeda H, Kawakami K. Insertional mutagenesis by the Tol2 transposon-mediated enhancer trap approach generated mutations in two developmental genes: *tcf7* and *synembryon-like*. *Development* 2008, 135:159–169. doi:10.1242/dev.009050.
137. Gaiano N, Amsterdam A, Kawakami K, Allende M, Becker T, Hopkins N. Insertional mutagenesis and rapid cloning of essential genes in zebrafish. *Nature* 1996, 383:829–832.
138. Ozato K, Wakamatsu Y. Developmental genetics of Medaka. *Dev Growth Differ* 1994, 36:437–443.
139. Ishikawa Y. Medakafish as a model system for vertebrate developmental genetics. *Bioessays* 2000, 22:487–495. doi:10.1002/(Sici)1521-1878(200005)22:5<487::Aid-Bies11>3.0.Co;2-8.
140. Loosli F, Koster RW, Carl M, Kuhnlein R, Henrich T, Mucke M, Krone A, Wittbrodt J. A genetic screen for mutations affecting embryonic development in medaka fish (*Oryzias latipes*). *Mech Dev* 2000, 97:133–139. doi:10.1016/S0925-4773(00)00406-8.
141. Furutani-Seiki M, Sasado T, Morinaga C, Suwa H, Niwa K, Yoda H, Deguchi T, Hirose Y, Yasuoka A, Henrich T, et al. A systematic genome-wide screen for mutations affecting organogenesis in Medaka, *Oryzias latipes*. *Mech Dev* 2004, 121:647–658. doi:10.1016/j.mod.2004.04.016.
142. Jiang XY, Sun CF, Zhang QG, Zou SM. ENU-induced mutagenesis in grass carp (*Ctenopharyngodon idellus*) by treating mature sperm. *PLoS ONE* 2011, 6:e26475. doi:10.1371/journal.pone.0026475.
143. Kuroyanagi M, Katayama T, Imai T, Yamamoto Y, Chisada S, Yoshiura Y, Ushijima T, Matsushita T, Fujita M, Nozawa A, et al. New approach for fish breeding by chemical mutagenesis: establishment of TILLING method in fugu (*Takifugu rubripes*) with ENU mutagenesis. *BMC Genomics* 2013, 14:786. doi:10.1186/1471-2164-14-786.
144. Endler JA. *Natural Selection in the Wild*. Princeton, NJ: Princeton University Press; 1986.
145. Griffiths AFJ, Miller JH, Suzuki DT, Lewontin RC, Gelbart WM. *An Introduction to Genetic Analysis*. 7th ed. New York: W. H. Freeman; 2000.
146. Flagel LE, Wendel JF. Evolutionary rate variation, genomic dominance and duplicate gene expression evolution during allotetraploid cotton speciation. *New Phytol* 2010, 186:184–193. doi:10.1111/j.1469-8137.2009.03107.x.
147. Doyle JJ, Flagel LE, Paterson AH, Rapp RA, Soltis DE, Soltis PS, Wendel JF. Evolutionary genetics

- of genome merger and doubling in plants. *Annu Rev Genet* 2008, 42:443–461. doi:10.1146/annurev.genet.42.110807.091524.
148. Okuyama Y, Tanabe AS, Kato M. Entangling ancient allotetraploidization in Asian *Mitella*: an integrated approach for multilocus combinations. *Mol Biol Evol* 2012, 29:429–439. doi:10.1093/molbev/msr236.
149. Buggs RJA, Wendel JF, Doyle JJ, Soltis DE, Soltis PS, Coate JE. The legacy of diploid progenitors in allopolyploid gene expression patterns. *Philos Trans R Soc Lond B Biol Sci* 2014, 369:20130354. doi:10.1098/rstb.2013.0354.
150. Adams KL, Cronn R, Percifield R, Wendel JF. Genes duplicated by polyploidy show unequal contributions to the transcriptome and organ-specific reciprocal silencing. *Proc Natl Acad Sci USA* 2003, 100:4649–4654. doi:10.1073/pnas.0630618100.
151. Liu Z, Adams KL. Expression partitioning between genes duplicated by polyploidy under abiotic stress and during organ development. *Curr Biol* 2007, 17:1669–1674. doi:10.1016/j.cub.2007.08.030.
152. Adams KL, Wendel JF. Polyploidy and genome evolution in plants. *Curr Opin Plant Biol* 2005, 8:135–141. doi:10.1016/j.pbi.2005.01.001.
153. Uno Y, Nishida C, Takagi C, Ueno N, Matsuda Y. Homoeologous chromosomes of *Xenopus laevis* are highly conserved after whole-genome duplication. *Heredity* 2013, 111:430–436. doi:10.1038/hdy.2013.65.
154. Xu P, Zhang X, Wang X, Li J, Liu G, Kuang Y, Xu J, Zheng X, Ren L, Wang G, et al. Genome sequence and genetic diversity of the common carp, *Cyprinus carpio*. *Nat Genet* 2014, 46:1212–1219. doi:10.1038/ng.3098.
155. Ojima Y. *Fish Cytogenetics*. Suiko-sha: Tokyo; 1983.
156. David L, Blum S, Feldman MW, Lavi U, Hillel J. Recent duplication of the common carp (*Cyprinus carpio* L.) genome as revealed by analyses of microsatellite loci. *Mol Biol Evol* 2003, 20:1425–1434. doi:10.1093/molbev/msg173.
157. Volff JN. Genome evolution and biodiversity in teleost fish. *Heredity* 2004, 94:280–294. doi:10.1038/sj.hdy.6800635.
158. Crow KD, Wagner GP. What is the role of genome duplication in the evolution of complexity and diversity? *Mol Biol Evol* 2006, 23:887–892. doi:10.1093/molbev/msj083.
159. Amores A, Force A, Yan Y-L, Joly L, Amemiya C, Fritz A, Ho RK, Langeland J, Prince V, Wang Y-L, et al. Zebrafish hox clusters and vertebrate genome evolution. *Science* 1998, 282:1711–1714. doi:10.1126/science.282.5394.1711.
160. Rutherford SL, Lindquist S. Hsp90 as a capacitor for morphological evolution. *Nature* 1998, 396:336–342. doi:10.1038/24550.
161. Bergman A, Siegal ML. Evolutionary capacitance as a general feature of complex gene networks. *Nature* 2003, 424:549–552. doi:10.1038/nature01765.
162. Masel J, Siegal ML. Robustness: mechanisms and consequences. *Trends Genet* 2009, 25:395–403. doi:10.1016/j.tig.2009.07.005.
163. Draghi JA, Parsons TL, Wagner GP, Plotkin JB. Mutational robustness can facilitate adaptation. *Nature* 2010, 463:353–355. doi:10.1038/nature08694.
164. Li IJ, Chang CJ, Liu SC, Abe G, Ota KG. Postembryonic staging of wild-type goldfish, with brief reference to skeletal systems. *Dev Dyn* 2015, 244:1485–1518. doi:10.1002/dvdy.24340.
165. Sato T, Takahoko M, Okamoto H, HuC:Kaede, a useful tool to label neural morphologies in networks in vivo. *Genesis* 2006, 44:136–142. doi:10.1002/gene.20196.
166. Cheng KC, Xin X, Clark DP, La Riviere P. Whole-animal imaging, gene function, and the Zebrafish Phenome Project. *Curr Opin Genet Dev* 2011, 21:620–629. doi:10.1016/j.gde.2011.08.006.
167. Pan YA, Freundlich T, Weissman TA, Schoppik D, Wang XC, Zimmerman S, Ciruna B, Sanes JR, Lichtman JW, Schier AF. Zebrafish: multispectral cell labeling for cell tracing and lineage analysis in zebrafish. *Development* 2013, 140:2835–2846. doi:10.1242/dev.094631.
168. Weber T, Köster R. Genetic tools for multicolor imaging in zebrafish larvae. *Methods* 2013, 62:279–291. doi:10.1016/j.ymeth.2013.07.028.
169. Zelditch M, Swiderski D, Sheets HD. *Geometric Morphometrics for Biologists: A Primer*. 2nd ed. Amsterdam and London: Elsevier Academic; 2012.
170. Nunn CL, Smith KK. Statistical analyses of developmental sequences: the craniofacial region in marsupial and placental mammals. *Am Nat* 1998, 152:82–101. doi:10.1086/286151.
171. Schmidt K, Starck JM. Developmental variability during early embryonic development of zebra fish, *Danio rerio*. *J Exp Zool B Mol Dev Evol* 2004, 302:446–457. doi:10.1002/jez.b.21010.
172. Goswami A, Weisbecker V, Sanchez-Villagra MR. Developmental modularity and the marsupial-placental dichotomy. *J Exp Zool B Mol Dev Evol* 2009, 312B:186–195. doi:10.1002/jez.b.21283.
173. de Jong IM, Colbert MW, Witte F, Richardson MK. Polymorphism in developmental timing: intraspecific heterochrony in a Lake Victoria cichlid. *Evol Dev* 2009, 11:625–635. doi:10.1111/j.1525-142X.2009.00370.x.
174. Koyabu D, Endo H, Mitgutsch C, Suwa G, Catania KC, Zollikofer CP, Oda S, Koyasu K, Ando M, Sanchez-Villagra MR. Heterochrony and developmental modularity of cranial osteogenesis in

- lipotyphlan mammals. *EvoDevo* 2011, 2:21. doi:10.1186/2041-9139-2-21.
175. Wu R, Lin M. Functional mapping—how to map and study the genetic architecture of dynamic complex traits. *Nat Rev Genet* 2006, 7:229–237. doi:10.1038/nrg1804.
176. Wu R, Ma CX, Lin M, Casella G. A general framework for analyzing the genetic architecture of developmental characteristics. *Genetics* 2004, 166:1541–1551.
177. Sun L, Wu R. Mapping complex traits as a dynamic system. *Phys Life Rev* 2015, 13:155–185. doi:10.1016/j.plrev.2015.02.007.
178. von Baer KE. *Über Entwicklungsgeschichte der Thiere: Beobachtung und Reflexion*. Königsberg: Bornträger; 1828.
179. Gould SJ. *Ontogeny and Phylogeny*. Cambridge, MA and London: Belknap Press of Harvard University Press; 1977.
180. Irie N, Kuratani S. Comparative transcriptome analysis reveals vertebrate phylotypic period during organogenesis. *Nat Commun* 2011, 2:248. doi:10.1038/ncomms1248.