



Contents lists available at ScienceDirect

Saudi Pharmaceutical Journal

journal homepage: www.sciencedirect.com



Review

A review on extraction techniques and therapeutic value of polar bioactives from Asian medicinal herbs: Case study on *Orthosiphon aristatus*, *Eurycoma longifolia* and *Andrographis paniculata*Nur Amanina Abd Aziz^{a,b}, Rosnani Hasham^{a,b,*}, Mohamad Roji Sarmidi^{b,c}, Siti Hasyimah Suhaimi^{a,b}, Mohamad Khairul Hafiz Idris^{a,b}^a Institute of Bioproduct Development, Universiti Teknologi Malaysia, 81310 Johor Bahru, Johor, Malaysia^b School of Chemical and Energy Engineering, Faculty of Engineering, Universiti Teknologi Malaysia, 81310 Johor Bahru, Johor, Malaysia^c Phyto Biznet Sdn Bhd, UTM-MTDC Technology Centre, Technovation Park, Universiti Teknologi Malaysia, 81300 Johor Bahru, Johor, Malaysia

ARTICLE INFO

Article history:

Received 17 September 2020

Accepted 31 December 2020

Available online 7 January 2021

Keywords:

Medicinal plants

Orthosiphon aristatus (OA)*Eurycoma longifolia* (EL)*Andrographis paniculata* (AP)

Extraction methods

Rosmarinic acid

Eurycomanone

Andrographolide

Binary solvent system

ABSTRACT

Medicinal plants have gained much interest in the prevention and treatment of common human disease such as cold and fever, hypertension and postpartum. Bioactive compounds from medicinal plants were synthesised using effective extraction methods which have important roles in the pharmaceutical product development. *Orthosiphon aristatus* (OA), *Eurycoma longifolia* (EL) and *Andrographis paniculata* (AP) are among popular medicinal herbs in Southeast Asia. The major compounds for these medicinal plants are polar bioactive compounds (rosmarinic acid, eurycomanone and andrographolide) which have multiple benefits to human health. The bioactive compounds are used as a drug to function against a variety of diseases with the support of scientific evidence. This paper was intended to prepare a complete review about the extraction techniques (e.g. OA, EL and AP) of these medicinal plants based on existing studies and scientific works. Suitable solvents and techniques to obtain their major bioactive compounds and their therapeutic potentials were discussed.

© 2021 The Authors. Published by Elsevier B.V. on behalf of King Saud University. This is an open access article under the CC BY-NC-ND license (<http://creativecommons.org/licenses/by-nc-nd/4.0/>).

Contents

1. Introduction	144
2. <i>Orthosiphon aristatus</i> , <i>Eurycoma longifolia</i> and <i>Andrographis paniculata</i> and their chemical constituents.	144
3. Extraction techniques	147
4. Solvent system	150
5. Overview of studies regarding extraction techniques and the effect of solvents on extraction of polar bioactive compounds	152
5.1. O. Aristatus (<i>Misai kucing</i>)	152
5.2. E. Longifolia (<i>Tongkat ali</i>)	153
5.3. A. Paniculata (<i>Hempedu bumi</i>)	159
6. Conclusion	161
Funding	161
Declaration of Competing Interest	161

* Corresponding author at: Institute of Bioproduct Development, Universiti Teknologi Malaysia, 81310 Johor Bahru, Johor, Malaysia.

E-mail address: rosnani@ibd.utm.my (R. Hasham).

Peer review under responsibility of King Saud University.

<https://doi.org/10.1016/j.jsps.2020.12.016>

1319-0164/© 2021 The Authors. Published by Elsevier B.V. on behalf of King Saud University.

This is an open access article under the CC BY-NC-ND license (<http://creativecommons.org/licenses/by-nc-nd/4.0/>).

Acknowledgement 161
 References 161

1. Introduction

Plants were once considered as a daily food. Now, plants are popular used as a common source in medicinal agents, food additives, cosmeceuticals and nutraceuticals (Hendra et al., 2011). Although, the medicinal properties of plants have gained attention, many research studies are still conducted to discover their values because the utilisation of synthetic drugs to heal or control most chronic diseases have caused several long-term effects. There is rising approach regarding the application of herbal medicinal plants in treating diseases with minimal or no aftereffects. Therefore, the extraction of bioactive compounds from herbal medicinal plants offers great potentials for new drug discoveries.

These therapeutically useful medicinal compounds in plants are extracted or separated by using selective solvents through a standard procedure. Generally, the extraction techniques can be divided into two categories, namely classical technique and modern technique. The former technique faces several limitations, such as the use of excess solvents, time-consuming and a long heating time which could risk the degradation of bioactive compounds. In most cases, extraction by using these solvents was hazardous and toxic to human health and the environment. Organic solvents release greenhouse gases into the environment, threatening humans, agriculture and microorganisms. Moreover, the usage of excess solvent produces a large amount of waste by-products. Contrary to the hazardous classical techniques, environmentally-friendly extraction approaches like ‘green solvents’, ‘green processing’ and ‘green product’ are favoured. Green extraction methods should be applied to encourage efficient and safe extraction method. Green extraction methods reduce energy consumption

which allow the use of alternative solvents and renewable natural sources to produce a safe and high-quality product (Easmin et al., 2015). Therefore, these modern extraction techniques are considered as green processing. These techniques reduce the usage of organic solvents, minimise bioactive compounds degradation in the sample and improve extraction efficiency.

In this review, chemical constituents of the bioactive compounds, extraction techniques, solvent extraction for certain bioactive compounds, and biological activities of *Orthosiphon aristatus* (Blume) Miq., *Eurycoma longifolia* (Jack) and *Andrographis paniculata* (Burm.f.) Nees, will be extensively discussed.

2. *Orthosiphon aristatus*, *Eurycoma longifolia* and *Andrographis paniculata* and their chemical constituents

Active constituents found in *Orthosiphon aristatus* (*O. aristatus*) are terpenoids, polyphenols and sterols (Tezuka et al., 2000). Polyphenols are the dominant constituents in *O. aristatus* (Hollman and Katan, 1999). Polyphenol compounds can be divided into five groups, which are phenolic acids, flavonoids, stilbenes, coumarins and tannins (Shahidi & Yeo, 2018; Li et al., 2014). Fig. 1 summarises the classification of polyphenol compounds.

It was reported that the major compound in *O. aristatus* is rosmarinic acid (RA) which belongs to the family of hydroxyl cinnamic acid and a derivative of caffeic acid (Petersen & Simmonds, 2003). RA can be found in the stems and leaves of *O. aristatus* (Koay & Amir, 2012). However, the availability of RA in stems, branches and the whole plant was less than that of leaves. RA is the most abundant polyphenol in *O. aristatus* leaves (Almatar & Rahmat, 2014; Akowuah et al., 2012). Besides RA, other

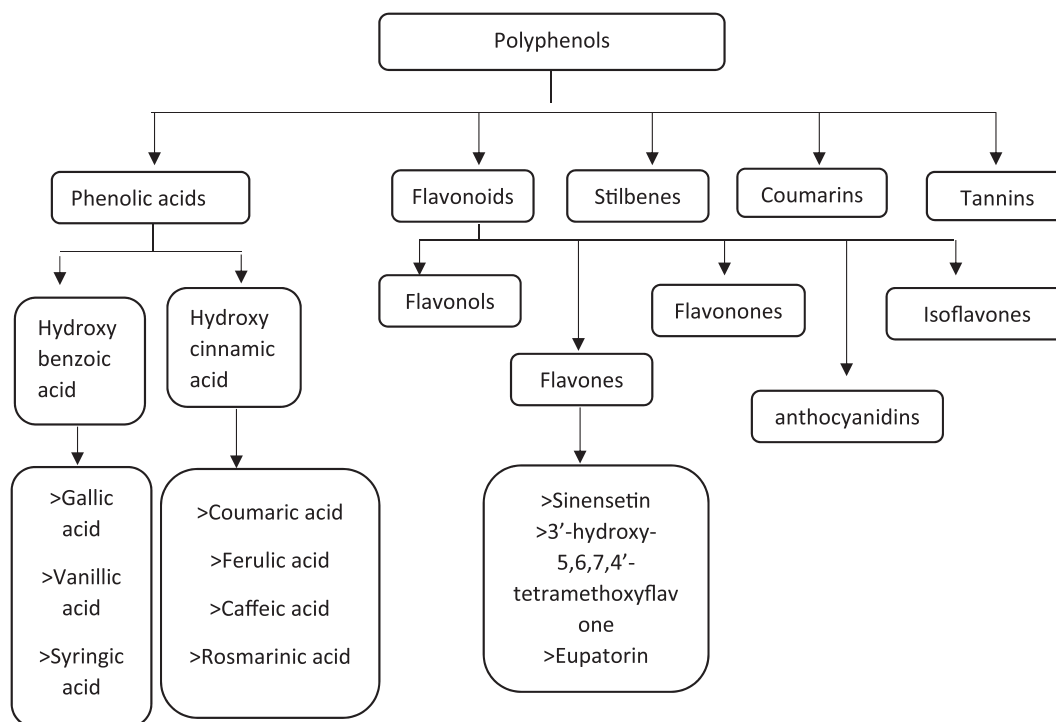

Fig. 1. Classification of polyphenol compounds.

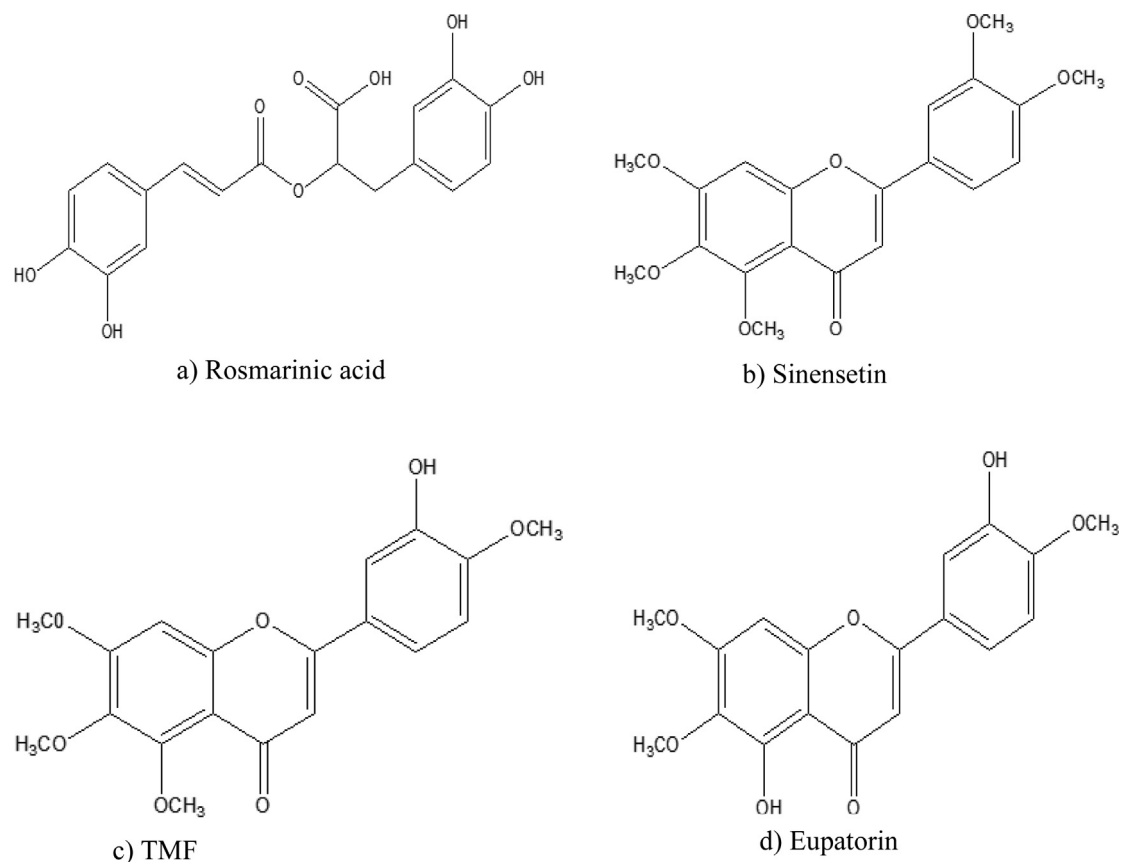

Fig. 2. Illustration of the chemical configurations of a) Rosmarinic acid, b) Sinensetin, c) TMF and d) Eupatorin.



Fig. 3. *E. longifolia* (Bhat and Karim, 2010).

important bioactive components found in *O. aristatus* leaves are flavonoids: sinensetin (SEN), 3'-hydroxy-5,6,7,4'-tetramethoxyflavone (TMF) and eupatorin. Based on previous research, sinensetin and TMF isolated from genus *Orthosiphon* demonstrated diuretic

activity in rats (Schut & Zwaving, 1993). Fig. 2 illustrates the chemical structures of RA, SEN, TMF and eupatorin.

Eurycoma longifolia Jack or locally known as *tongkat ali* in Malaysia, which is from Simaroubaceae family (Fig. 3), is one of the most popular tropical herbal medicinal plants in Southeast Asian countries. *Tongkat ali* is an evergreen slow-growing herbal plant that completely matures after 25 yr and can be harvested only after 5 yr of cultivation (Mohd Effendy et al., 2012; Bhat and Karim, 2010). Therefore, this plant has been considered as a new source for an entry point project (EPP) under The Agriculture National Key Economic Area (NKEA) to enhance Malaysia's herbal industry besides hempedu bumi, misai kucing, dukung anak and kacip fatimah (Ahmad et al., 2015). This is due to a survey by the Forest Research Institute Malaysia (FRIM) which found about 73% of households in Malaysia were consuming herbal-based products based (Safie et al., 2015), which was lower as compared to World Health Organisation (WHO) estimation. About 80% of consumers relied on herbal-based products for their primary healthcare (Zakaria et al., 2019). To achieve the objective of EPP, various ways were applied, whereby some of them were either on the standardisation and product development, preclinical studies or clinical studies.

Each plant has its own medicinal value which depends on the presence of bioactive components that have therapeutic effects (Yaqub et al., 2016; Alamgir, 2018). A multitude of research studies claimed that *Eurycoma longifolia* (*E. longifolia*) has potential in aphrodisiac, antimalarial, anticancer and antimicrobial (Rehman et al., 2016; Abu Bakar et al., 2017; Bhat et al., 2010). Quassinoids, cathin-6-one alkaloids, squalene type triterpenes, tirucallane-type triterpenes and biphenylneolignans are several major metabolites that were reported in *tongkat ali* plant (Abu Bakar et al., 2017).

Table 1
Therapeutic effects of eurycomanone and its derivatives from EL extracts/products.

Bioactivity	Active extracts/products	References
Intracellular lipid metabolism in hepatocytes cells	Aqueous root extract	Lim et al., 2019
Bioavailability of eurycomanone in vivo and in vitro studies of rats and mice	Standardized water extract with 1.36% eurycomanone	Ahmad et al., 2018
Lipolytic activity in 3 T3-L1 adipocytes	50% Aqueous methanol roots extract	Lahrita et al., 2017
Stress hormones and psychological mood state	PHYSTA freeze-dried water extract (200 mg)	Talbott et al., 2013
Testosterone and estrogen production in the rat testicular Leydig cell-rich interstitial cells.	95% methanol root extract	Low et al., 2013
Eurycomanone suppress the expression of human lung cancer cell (A549) including markers prohibitin, annexin 1 and endoplasmic reticulum protein 28	Methanol root extracts	Wong et al., 2012
Quality of life, physical performance and sexual well-being in men	PHYSTA freeze-dried water extract (300 mg)	Ismail et al., 2012
Cytotoxicity of eurycomanone and antiproliferative activity on cancerous cell lines (Caov-3, HeLa, Hep G2, HM3KO and MCF-70)	Aqueous methanol root extracts	Mahfudh and Pihie, 2008

Quassinoids is a kind of derivative degraded from terpenoids (Li et al., 2019) and then degraded into C-18, C-19, C-20, C-22 and C-25 types (Majidi Wizneh & Zaini Asmawi, 2014; Elhag et al., 2016; Abu Bakar et al., 2017). Compounds which are secondary metabolites, such as eurycomanone, 9-methoxycanthin 6-one, 14,

15- β -dihydroxyklaineaneone and 13, 21-epoxyeurycomanone were used as standard markers for the standardisation of EL extracts or EL-based products (Norhidayah et al., 2015).

A study by Jusoh et al. (2015) found that the root consisted of a high content of eurycomanone, a bioactive from quassinoid metabolites that possess a high medicinal value, and was supported by Masayu et al. (2017). A series of studies revealed that the bioactivity of eurycomanone major compounds in EL, including other derivatives, led to promising abilities such as boost energy, enhance muscle mass, increase bone mass and improve sexual problems. Apart from eurycomanone, several derivatives from EL, such as eurycomanone dibutyrate, eurycomanone monovalerate, eurycomanone dimethoxybenzene, eurycomanone disuccinate, 9-methoxycanthin-6-one, eurycomanol, eurylactone D, E, and F, pasakbumin C, pasakbumin B and others metabolites have therapeutic effects which need to be explored more. Table 1 summarises several studies on EL and their therapeutic effects. Fig. 4 illustrates the chemical structure eurycomanone compound and two other derivatives.

Geographically, *Andrographis paniculata* (*A. paniculata*) grows largely in India, China, and Thailand. The plant extracts, particularly from the aerial region, is known to contain diterpene, flavonoid, and stigmasterol. In Ayurveda, AP is one of the most used herbs in the formulation of polyherbal concoctions. About 26 formulations were known to incorporate the use of AP as one of the crucial ingredients (Kumar et al., 2004). Research following the medicinal claims of the herb revealed that AP has the potential as antiinflammatory, antiviral, antithrombotic (preventing blood clotting), anticancer, immunostimulatory, hypoglycaemic (lowering glucose level), and hypotensive (lowering blood pressure) agents (Kumar et al., 2004).

It was established that the main bioactive phytochemicals contained within AP are andrographolide, a diterpenoid lactone

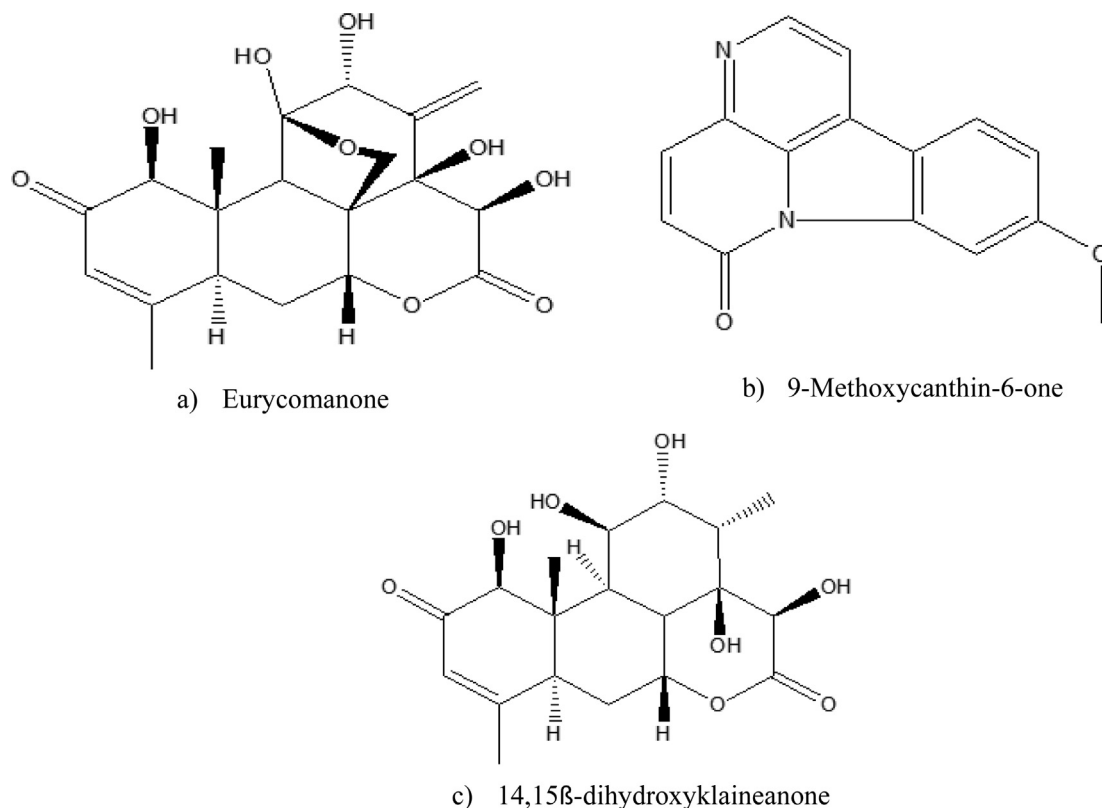

Fig. 4. Chemical structures of a) Eurycomanone, b) 9-Methoxycanthin-6-one and c) 14,15 β -dihydroxyklaineaneone.

Table 2
The therapeutic effects of *A. paniculata* extract and its isolated components.

Pharmacological Activity	Active Compound	Reference
Computational investigation revealed the potential of <i>A. paniculata</i> against SARS-CoV-2 virus.	Neoandrographolide	Murugan et al., 2020
Anti-inflammatory and anti-quorum-sensing (QS) action of <i>A. paniculata</i> extracts against <i>Pseudomonas aeruginosa</i> infection.	Chloroform, methanol, and water extracts	Banerjee et al., 2017
<i>A. paniculata</i> at a dose of 50 mg/kg showed significant antihyperglycemic and antioxidative effect on Sprague-Dawley streptozotocin-induced diabetic rat.	Methanol extract	Kumar et al., 2017
<i>A. paniculata</i> extract enhanced the recovery from CCl ₄ -induced hepatic damage in albino rats.	Whole plant ethanol extract	Subramaniam et al., 2015
Andrographolide from <i>A. paniculata</i> exhibited cytotoxicity and tumour specificity, also inducing caspase-3 activation of HSC-2 oral squamous cell carcinoma cells.	Methanol extract of the leaves, recovered by partitioning with EtOAc, followed by silica gel chromatography.	Suzuki et al., 2016
<i>A. paniculata</i> isolated phytochemical, 14-deoxyandrographolide, potentially inhibit inflammatory responses by acting on COX-2 and superoxide radicals.	Ethanol extract. Defatting with hexane and fractionated into chloroform and methanol. The methanol fraction was subjected to silica gel column chromatography	Shaikh et al., 2019

(Kumar et al., 2004). A series of studies which were focusing on exploring the medicinal capabilities of AP had many promising healing abilities. Table 2 tabulates the findings.

These findings showed that AP can serve as a possible therapeutic agent for a wide range of illnesses. Specifically, the healing effects are attributed to the bioactive components that are found in the plant. Andrographolide was shown to cause a number of curative effects. It was shown to inhibit inflammatory responses by rat neutrophils (Xu et al., 2002), exhibit hepatoprotective activity against intoxication of paracetamol and galactosamine in rats (Handa & Sharma, 1990), and prevent angiogenesis by regulating the production of various pro-angiogenic and antiangiogenic factors, such as pro-inflammatory cytokine, nitric oxide and vascular endothelial growth factor (Sheeja et al., 2007).

On the other hand, neoandrographolide was demonstrated to suppress macrophages nitric oxide (NO) production by 35% and 40% after the compound was orally administered to the test mouse at 5 mg/kg/d and 25 mg/kg/d (Batkhoo et al., 2002). The oral administration of neoandrographolide also significantly suppressed ear oedema induced by dimethyl benzene in mice, and it reduced the increase in vascular permeability induced by acetic acid in mice (Liu et al., 2007). A study to determine the chemosensitising potential (in a leukaemia cell line) of the AP fractions has revealed that the combination of neoandrographolide with suboptimal concentrations of etoposide exhibit a chemosensitizing effect in S-Jurkat and X chromosome-linked inhibitor of apoptosis protein (XIAP)-overexpressing Jurkat cells, a model for chemoresistance (Pfisterer et al., 2010).

Apart from that, deoxyandrographolide, which is another component of AP that was known for its anti-hepatitis B activity (Chen

et al., 2014). In a previous study to determine the effects of deoxyandrographolide on oral cancer cell migration and invasion, the compound was observed to significantly inhibit the migration and invasion abilities of SCC9 (tongue squamous cancer) cells in vitro. In the study, deoxyandrographolide inhibited the phosphorylation of ERK1/2, p38, and JNK 1/2 in SCC9 cells, inhibiting of the invasion and metastasis of human oral cancer cells (Hsieh et al., 2017). Deoxyandrographolide was also shown to induce oral cancer cell death by activating autophagy. The compound induced autophagy by triggering the activation of JNK1/2 and the inhibition of Akt and p38. Administration of deoxyandrographolide also effectively suppressed tumour formation in the oral carcinoma xenograft model in vivo (Hsieh et al., 2015). Fig. 5 illustrates the chemical structure of andrographolide, neoandrographolide and deoxyandrographolide.

3. Extraction techniques

The most crucial first step in the analysis of medicinal plants is extraction because the desired bioactive compound needs to be extracted from the plant for further investigation like fractionation and separation. Generally, the extraction of plant extracts can be defined as a separation process, whereby the bioactive compounds are isolated from the plant. Different parts of the plant produce different phytochemical contents due to the plant matrices (SaraJlija et al., 2012; Rehman et al., 2020). The suitability of an extraction process depends on the target compound which could be non-polar, polar or both.

Plant materials can be used in dried or fresh form. However, the dried form is preferred over the fresh plant sample. This is because the fresh sample can deteriorate faster as compared to dried sample, and it is advised that the fresh sample is quickly used for experimental work, which is not more than 3 h after harvesting (Azwanida, 2015). Choice of drying technique may also influence the quality of biomolecules.

The most frequently used drying techniques are air-drying, oven-drying, and microwave-drying. Air-drying of the sample can take weeks or months, depending on the sample. Since this type of drying technique does not force the process to use an increased temperature, the heat-sensitive compound can be preserved. However, extended exposure to the environment and slow dehydration of water molecules could contaminate the sample and introduce invasion of mould and parasite (Azwanida, 2015). Microwave-drying utilises electromagnetic radiation to excite the rotational motion of molecules; subsequently, this causes heat generation within the system, and thus, accelerates the drying process and shortens the overall drying time. However, rigorous collision and excitement of the molecules can trigger the degradation of the active compounds (Azwanida, 2015). Another easier and rapid drying method is by using an oven that makes use of temperature manipulation. This method is considered safer for most phytochemicals since it reduces the possibility of degradation of bioactive compounds (Azwanida, 2015). Another influential pre-extraction factor is a size reduction process. It is desired that the size of plant materials be reduced to aid the penetration of extraction solvent to targeted analytes. This is achievable by grinding the plant materials with a grinder. It was reported that particle size of smaller than 0.5 mm is the ideal size for efficient extraction process (Azwanida, 2015). However, there are limitation for size of plant materials which should not less than 125 µm as they prefer to float (Yeop et al., 2017).

Among the two different extraction techniques, the classical extraction technique requires simple operations such as maceration, Soxhlet and reflux (Latiff, 2015). Maceration is a technique that involves soaking of plant materials (coarse or powdered) with

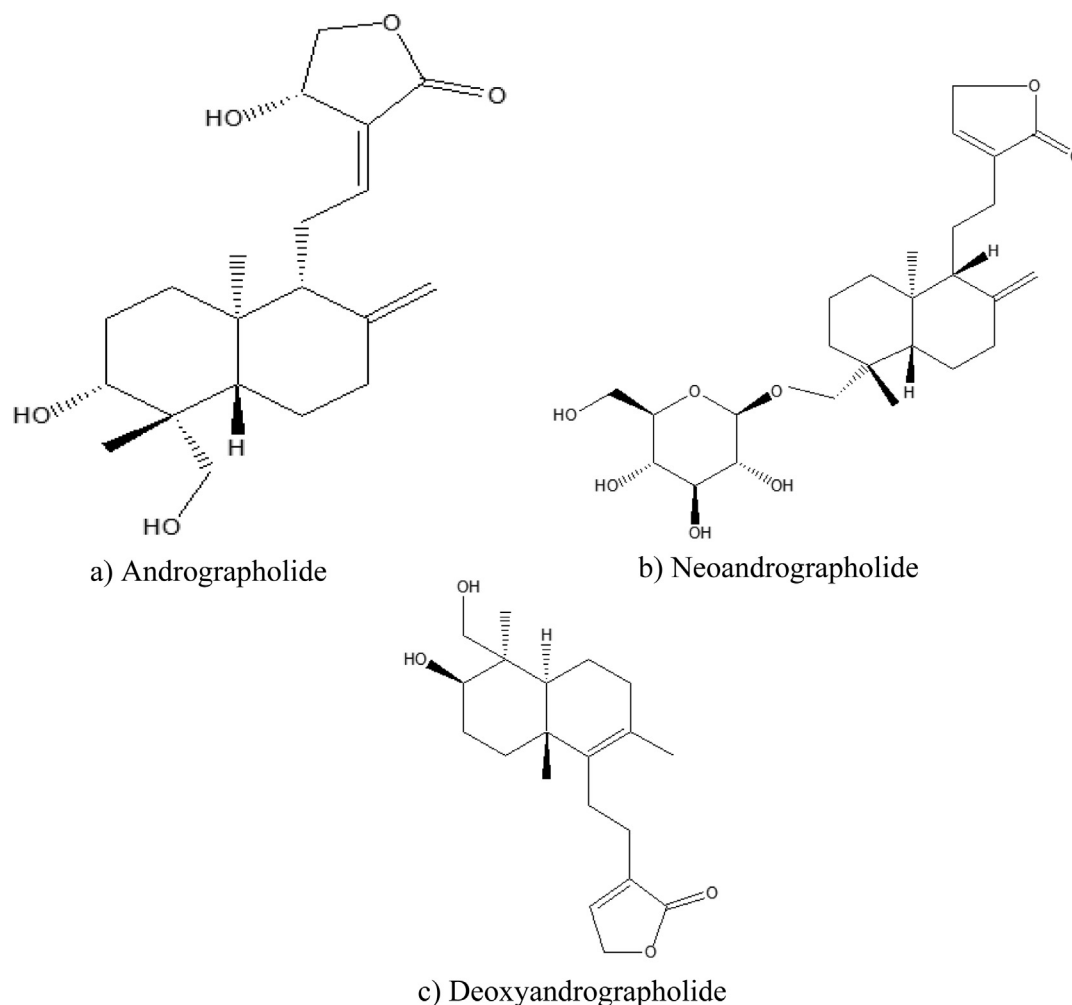

Fig. 5. Chemical structures of a) andrographolide, b) neoandrographolide and c) deoxyandrographolide.

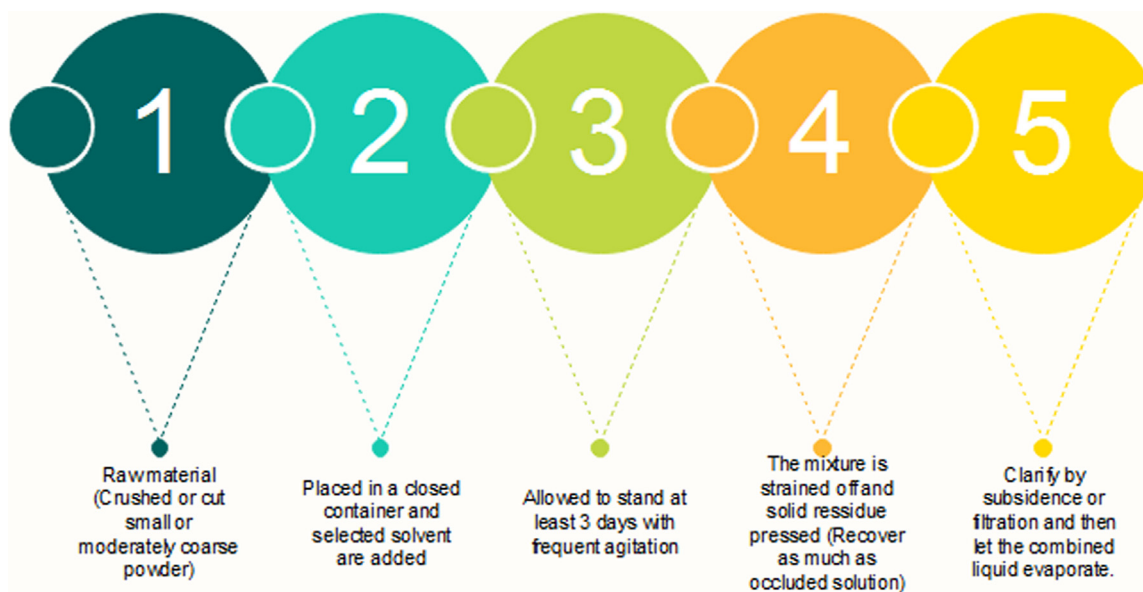

Fig. 6. General procedure of maceration technique (Singh, 2008).

a solvent and allowing it to stand in room temperature for a minimum period of 3 days with frequent agitation (Handa et al., 2008). It is the easiest and simplest extraction method. By using this tech-

nique, the plant cell wall can be ruptured to release soluble phytochemicals. Fig. 6 illustrates five simple steps in maceration method which need to be followed.

Meanwhile, by using Soxhlet extraction, the sample is placed inside a thimble which is made of a strong filter paper or cellulose and placed into a chamber of Soxhlet extractor. The process begins when the extraction solvent at the bottom flask is heated, evaporates into the sample thimble, condenses in the condenser and drips back (Azwanida, 2015). Soxhlet extraction is not an environmentally friendly method since it utilises hazardous and flammable liquid organic solvents which could potentially emit toxins during extraction. Additionally, the ideal sample of Soxhlet extraction is limited to dry and finely divided solids. On the other hand, reflux extraction is a solid–liquid extraction process performed at a constant temperature with repeated solvent evaporation–condensation step for a specified period of time without the loss of solvent (Chua et al., 2016). This method was reported as being widely used in herbal industries as it is efficient, easy to operate, and cost-effective (Wang et al., 2013).

However, classical methods are time-consuming. For example, maceration normally consume to 7 days, while, Soxhlet and solvent extraction requires 24 h and 2 days, respectively (Easmin et al., 2015). Moreover, the classical techniques involve overuse of organic solvents which are hazardous to health and the environment. The solvents are also costly and difficult to be completely removed. Fig. 7 displays examples of classical extraction techniques.

Since classical techniques can be harmful to humans and the environment due to the overuse of organic solvents, green extraction methods are essential. Apart from being environmentally friendly in minimising the use of hazardous solvents, this green processing method requires a shorter extraction time with a simple operating system. Some examples of modern extraction techniques are ultrasound-assisted extraction (UAE), microwave-assisted extraction (MAE) and supercritical fluid extraction (SFE).

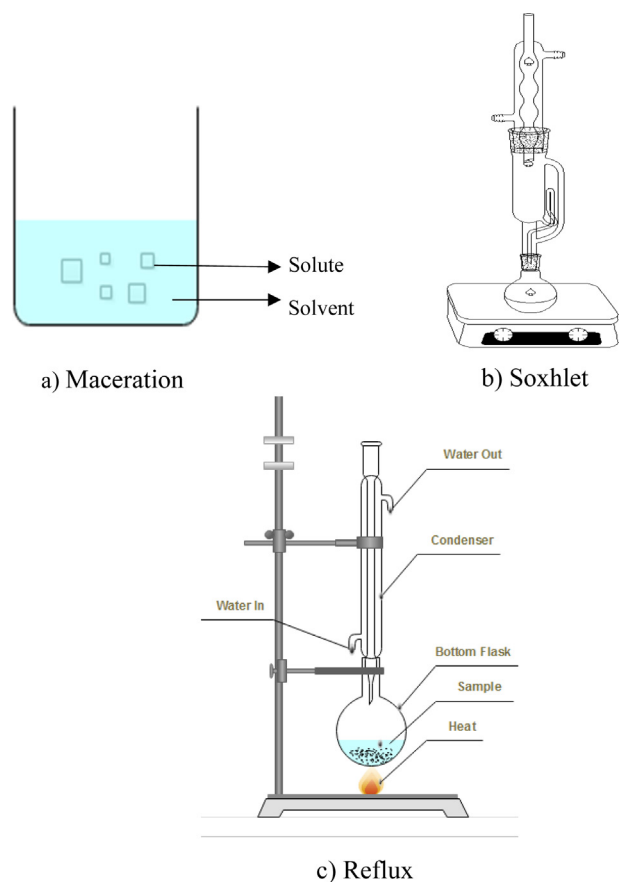

Fig. 7. Types of classical extraction techniques a) Maceration, b) Soxhlet c) Reflux.

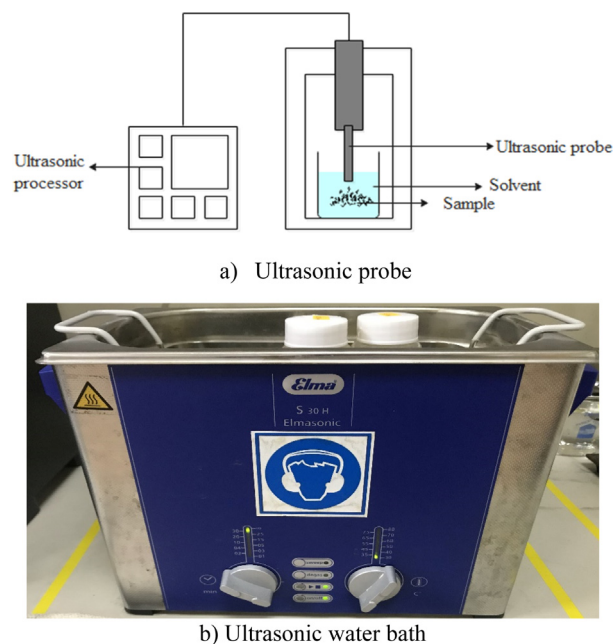

Fig. 8. Ultrasound-Assisted Extraction, UAE setup apparatus.

UAE provides high reproducibility, shorter extraction time, reduced solvent consumption, lower temperature, and lower energy input as compared to other classical methods (Bimkr et al., 2012). Generally, UAE uses ultrasound that range from 20 kHz to 2000 kHz (Handa et al., 2008). Throughout the sonication process, ultrasound produces cavitation bubbles from the ultrasonic waves that allow greater penetration of the extraction solvent into the plant cell walls, which is in contrast with other conventional methods (Lee & Lin, 2007). Moreover, ultrasonic waves can break the cell membranes to enhance inner mass transport (Zhang et al., 2009). Fig. 8 shows two types of UAE set up apparatus.

On the other hand, MAE employs microwave energy to expedite the partition of analytes from the sample matrix into the solvent (Anuradha et al., 2010). The mechanism involves microwave radiation interaction with dipoles of polarisable materials via conduction process, for example, solvents and sample. This process causes dipole rotation of molecules, disrupting of hydrogen bonding which enhances the migration of dissolved ions and helps solvent penetration into the matrix (Kaufmann & Christen, 2002). MAE was chosen as a selective method that favours polar molecules and solvents with high dielectric constant (Fig. 9).

Meanwhile, a supercritical fluid is a substance that shares the properties both gas and liquid at its critical points (Azwanida, 2015). SFE (Fig. 10) depends on the properties of the fluid solvent, namely, viscosity, density, diffusivity, and dielectric constant (Basa'ar et al., 2017). In addition, pressure and temperature are two important parameters in SFE to reach a supercritical fluid. SFE has the ability to set the solvent power for different compounds which can be achieved by tuning the pressure, temperature and co-solvent contents (Liza et al., 2010). Also, SFE uses low temperature for extraction which helps to prevent the degradation of bioactive compounds (Reverchon, 1997). Apart from that, ethylene, methane, nitrogen, xenon, fluorocarbons, and carbon dioxide are examples of solvents used in SFE. Among the six, carbon dioxide (CO₂) is the most commonly used solvent in SFE due to its safety and low cost. CO₂ is desired since it is non-explosive, non-toxic and can be easily removed from the final product, besides, having the power to solubilise lipophilic substances which makes it an

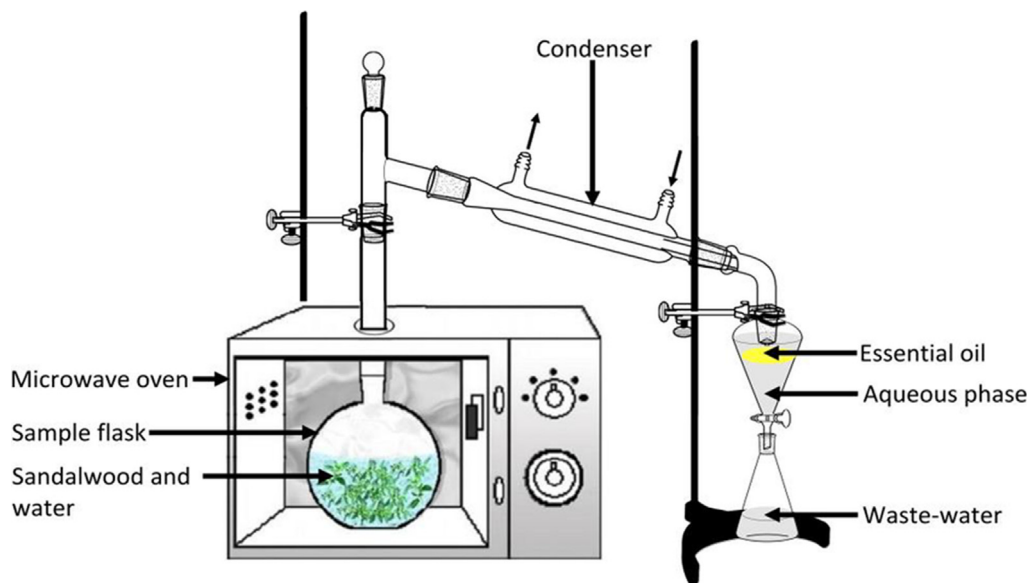

Fig. 9. Microwave-assisted extraction (Kusuma and Mahfud, 2016).

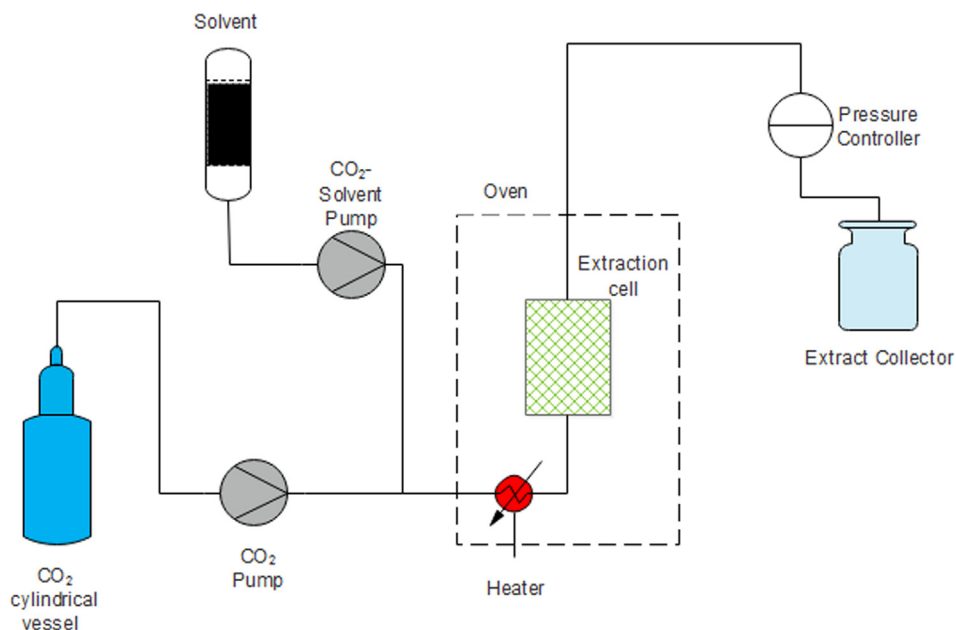

Fig. 10. Supercritical fluid extraction (SFE).

alternative to organic solvents. However, CO₂ is less effective in the extraction of highly polar compounds due to its low polarity, and thus, co-solvents such as hexane, ethanol, methanol isopropanol, acetonitrile or dichloromethane are used in small quantities to enhance the solubility and selectivity of the extraction (Sahena et al., 2012).

4. Solvent system

The choice of solvents for an extraction process is crucial in maximizing the extract yield and bioactivity of the plant extract (Waszkowiak et al., 2015). The selection of solvent relies on the specific nature of the targeted bioactive compound. Whereby, the polarity of the solvents is important in the extraction of the desired

bioactive compound. Solvents can be categorised according to their polarity such as polar, semi-polar and non-polar. Examples of polar solvents are water, acetonitrile, methanol and ethanol. Meanwhile non-polar solvents are acetone, chloroform and ethyl ether. Following the key principle of solubility ('like dissolve like'), the phytochemical compounds of varying polarity present in plant material can be extracted by using appropriate solvents (Abarca-Vargas et al., 2016). Therefore, a solvent with similar polarity to the desired polarity of bioactive compounds will properly be dissolved and then extracted (Altemimi et al., 2017).

According to a study by Bergs et al. (2013), to choose a better solvent to extract targeted compounds there are six standard steps which may be followed to extract the bioactive compounds from medicinal plants. Fig. 11, indicates standard guidelines of the selection of solvents suitable for the desired bioactive compounds

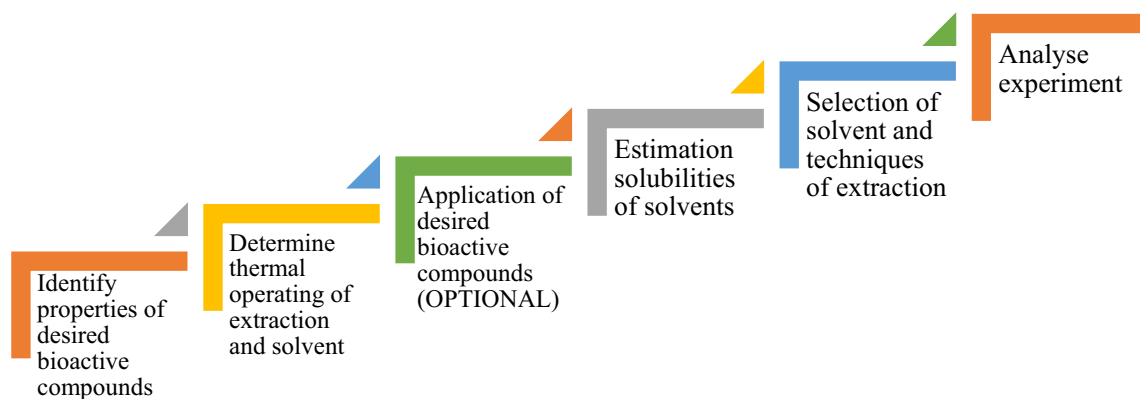

Fig. 11. Standard guidelines selection of solvents (Bergs et al., 2013).

extraction of medicinal plants. The first step is to identify the molecular weight, chemical structure, melting and boiling point and molar volume of the desired bioactive compounds. Through this, the later selection of extraction methods will be easier to choose.

Next, the thermal operating of extraction and solvent were identified to ensure that the apparatus for extraction and solvents are complete before the experiments begins. The list of solvents to be removed from experiments needs to be crossed if the boiling point of solvents was more than the temperature of desired bioactive compounds, including the equipment which cannot withstand the high temperature of solvents. Temperature stability of the desired compounds can be determined through literature review or preliminary study, and thus the list of solvents can be narrowed down.

Meanwhile, step 3 is optional to the user according to the application of desired bioactive compounds. In case of limitation such as used for food supplement, food stuff and others, the user may exclude solvent that illegal in an area application.

In step 4, the highest solubility of solvents with targeted compounds was chosen based on the calculation of Hansen Solubility Parameters (HSP), Hildebrand theory and COSMO/RS calculation (Laboukhi-Khorsi et al., 2017). The solubility results may reduce the number of solvent candidates and become environmental-friendly.

Step 5 explains the standard procedure of extraction as compared to different solvent candidates to determine the extraction yield and total yield of targeted compounds. Finally, the data obtained from each experiment based on the techniques of extraction and selectivity of solvents are analysed. By following these guidelines, the hazardous solvent may be excluded, green processing or green extraction will be achieved, and cost and time may be reduced.

As mentioned before, the polarity of solvent is important due to the targeted compound to be extracted from the plant. This is because a highly polar solvent such as water and a non-polar solvent, such as ethyl ether are not suitable to extract high polar compounds. Additionally, the use of water as a single solvent could cause an extract to have high content of impurities which can interfere with the identification and quantification of polar compounds (Hijazi et al., 2013).

Besides, solvents such as methanol, ethanol, acetone, propanol and ethyl acetate are the most common solvents used for plant material extraction. Methanol can be considered as one of the most used extraction solvents. However, the usage of methanol is often questioned because of its high toxicity to humans (Esther et al., 2003). Therefore, people find ethanol to be more attractive for

the extraction of a variety of compounds since it has similar chemical properties to methanol and is less toxic (Esther et al., 2003).

The polarity of solvents was selected by referring to the dielectric constant (δ), whereby the dielectric constant of the compounds is defined as the polarity index of a solvent. Greater δ , will have greater polarity. Table 3 describes the δ of different solvents which can be referred for the selection of solvent (Latiff, 2015).

However, most studies prefer a binary solvent system as compared to the mono-solvent system to extract bioactive compounds (Othman et al., 2015; Thoo et al., 2010; Wong et al., 2014). A binary solvent system (or known as bi-solvent system) is defined as a combination of two solvents (ionic liquids and/or organic solvents) with regard to their relative polarity (Othman et al., 2015). A study by Othman et al. (2015) had proved the binary solvent system's potential to increase the yield of targeted compounds of any herbal medicinal plants. The results given by 1-butyl-3-methylimidazolium trifluoromethanesulfonate (OTf) combined with acetone had the highest rotenone content as compared to other binary solvents and control (acetone). A study by Thoo et al. (2010) investigated the effects of binary solvent extraction on extraction time, extraction temperature, phenolics content and antioxidant activity. The result proved that 40% ethanol at 65 °C for 80 min was the optimal conditions to obtain a high yield of phenolic content and antioxidant activity. A similar result was obtained by Wong et al. (2014) which showed the binary solvent system was preferred in the extraction of kenaf seed. The previous study also showed that the binary solvent extraction system was the ideal method compared to the mono-solvent system (Wang et al., 2008; Zhang et al., 2007).

Table 3
Dielectric constant of different solvents (Ekrami & Shamlouei, 2018; Joshi & Adhikari, 2019).

Solvents	Dielectric constant (δ)
Water	80
Glycerin	42.5
Acetonitrile	37.5
Methanol	32.7
Ethanol	24.5
Acetone	21
Chloroform	4.81
Diethyl Ether	4.267
Hexane	1.89

5. Overview of studies regarding extraction techniques and the effect of solvents on extraction of polar bioactive compounds

5.1. *O. Aristatus* (Misai kucing)

O. aristatus was extracted by using either classical or modern technique. Start with Akowuah et al. (2005) investigated the effects of different extraction solvents on varying polarities for the extraction of major polyphenols in *O. aristatus* leaves. *O. aristatus* leaf powder was extracted by using solvents; such as water, 50% methanol, absolute methanol, 70% acetone and chloroform for 2 h, 4 h, and 8 h in a water bath at 40°C. The results indicated that chloroform extraction from 4 h to 8 h at 40°C gave the highest amount of sinensetin and eupatorine. The extraction method with 70% methanol at 4 h and 8 h produced a higher TMF yield. Meanwhile, it was observed that the use of 50% methanol for 8 h of extraction yielded higher rosmarinic acid (RA).

Further study was done by Akowuah and Zhari (2010) to find the best extraction temperature on the stability of major polyphenols (RA and sinensetin) from leaves of *O. aristatus* and their antioxidant activity by using the same extraction techniques, i.e. maceration. The results were analysed by using high-performance liquid chromatography (HPLC) and extraction at 40 °C had the highest yield of RA and sinensetin at (0.802±0.008)% and (0.084±0.006)%, respectively. The antioxidant activity was high at the same temperature as (78.34±1.42)%.

Then, Hossain and Ismail (2009) carried out maceration techniques to investigate the best solvent system for qualitative and quantitative determination of caffeic acid and RA with various extraction solvents (100% methanol, 50% methanol, 100% acetone, 70% acetone, 100% ethanol, 50% ethanol, chloroform and water) and extraction time (2 h, 4 h, 6 h and 8 h) from leaves of *O. aristatus*. The data were analysed qualitatively and quantitatively by using thin-layer chromatography (TLC), high-performance thin-layer chromatography (HPTLC) and HPLC. The confirmed chosen solvent to extract a high yield of RA were 70% acetone and 100% ethanol as the best solvent to extract caffeic acid after a two-hour extraction. Therefore, the semi-polar solvent was also suitable to extract a high yield of RA by using maceration techniques.

Extraction techniques similar to Akowuah et al. (2005; 2012) was done by Ho and co-workers in 2010 to obtain a high yield of RA by using different concentrations of methanol (25%,50%,75%,100%) and water. A whole part of *O. aristatus* was used in the extraction and tested for their antimicrobial and antioxidant activities against food-borne bacteria in vitro. The results revealed that 50% methanolic extract had the highest antibacterial and antioxidant activity due to the highest presence of RA.

Furthermore, Razak et al. (2012) investigated the effects of varying solvent polarities. The selected solvents for the study were water, ethyl acetate, hexane and ethanol. The solid-liquid extraction method was used for the extraction of *O. aristatus* compounds. The highest extraction yield was obtained from water extract, followed by ethyl acetate, ethanol and hexane. The results suggested that the major phytochemical components in *O. aristatus* leaves were mostly high in polarity and soluble in water. Therefore, a solvent that is more soluble in water is suitable to extract high polar bioactive compounds from *O. aristatus*, such as their biomarkers, RA, eupatorin and sinensetin.

Lau et al. in 2014 studied the optimisation and kinetics of RA extraction from *O. aristatus* by using reflux extraction technique. The central composite design (CCD) was employed. In this study, dried plant samples were extracted by using different ethanol concentrations, solvent to solid loading ratios, temperatures, and times. The kinetic study of the extraction was performed in a

2.5L extractor under reflux by using optimum extraction conditions. The two-site kinetic model was the most appropriate model to describe the RA extraction from *O. aristatus*. Results revealed that the optimal conditions for the RA extraction by using reflux techniques were the concentration of ethanol at 79% v/v, solvent to solid loading ratio at 9:14, extraction temperature at 56.53 °C and extraction time of 3 h.

Furthermore, Saidan and friends in 2015 employed three extraction techniques to extract *O. aristatus*, which were maceration, Soxhlet and reflux. The selected metabolites profiling was analysed by using HPLC, UV-vis, and Fourier transform infrared spectroscopy (FTIR) techniques. In maceration and Soxhlet techniques (at 50 °C for 48 h), 100% methanol, 100% ethanol, 50% methanol and 50% ethanol were used as solvents. But, for water extraction reflux and maceration (25 °C for 72 h) techniques were applied. The results revealed that ethanolic extracts of *O. aristatus* characterised high contents of phenolics and flavonoids (RA and eupatorin). Meanwhile, 50% ethanolic extracts and absolute methanolic extracts had high contents of proteins and glycosaponins. However, absolute methanolic extract indicated the highest content of total glycosaponins with 30.4 ± 0.6% w/w. Water extract yields high contents of polysaccharides with 23.7% w/w of crude extract. These findings indicated that the polysaccharide content in *O. aristatus* was water-soluble, and ethanol solvent was suitable to extract high content of polar bioactive compounds, which was RA and eupatorin by using maceration techniques as compared to other techniques.

Next, a study by Pang and friends in 2015 investigated the effect of solvents and extraction techniques (maceration and ultrasound-assisted extraction, UAE) on polyphenols (RA, sinensetin and eupatorin) from *O. aristatus* leaves. The solvents used in the extraction process were methanol, isopropanol, water, 50% methanol, 70% methanol, 50% isopropanol and 70% isopropanol. The results showed that sinensetin and eupatorin compounds, which are lipophilic (i.e. tend to dissolve in fats or lipids), were more soluble in a low polar solvent such as isopropanol which resulted in 261.21 ± 1.01 µg sinensetin/g dry weight and 2.71 ± 0.02 µg eupatorin/g dry weight, respectively, by using UAE techniques. This result was similar to Akowuah et al. (2005). Meanwhile, RA is hydrophilic (attract to water molecules) and more soluble to methanol as compared to isopropanol. Therefore, the methanol solvent (70% aqueous methanol) was suitable to extract a high yield of RA by using UAE techniques. The UAE techniques have advantages to be chosen as compared to maceration techniques since UAE techniques only need a shorter time; 90 min as compared to 4 h.

Further study was done in the same year by focusing on UAE techniques to identify the effect of solvents on phenolic and flavonoids content from *O. aristatus* leaves. The study was done by Pang and friends to prove that the hypothesis and results obtained before were accurate and acceptable. Based on the findings, the highest phenolic content that was obtained from UAE techniques was 70% aqueous methanol solvent and 70% isopropanol. However, the highest flavonoids content was obtained in 70% isopropanol solvent. Since RA was from the phenolic group and hydrophilic compounds, 70% aqueous methanol was the most suitable solvent to extract a high yield of RA as compared to isopropanol. Also, the study reported that extraction after 120 min or at a temperature higher than 70°C caused degradation of compounds and may reduce the extraction yield.

In another study, the leaves of *O. aristatus* were extracted via maceration by using absolute ethanol, 50% ethanol and water as solvents. The experiment was conducted for 6 h at room temperature. The biomarker (RA, sinensetin and eupatorin) contents of the extracts were evaluated by using TLC and were found to have all three biomarkers (Mansor et al., 2016). Besides, the extraction of

bioactive compounds also used Soxhlet extraction and reflux extraction techniques for 6 h. Based on these findings, the study revealed that reflux method generated a high yield of total extraction (72.73%) as compared to Soxhlet and maceration techniques by using 50% ethanol as the best solvent as compared to absolute ethanol and water. These findings suggested that the binary solvent system was able to extract both non-polar and polar bioactive compounds and together enriched the RA quantity in the extract.

Additionally, the effects of solvents on *O. aristatus* leaves were further discussed by Kamarudin et al. (2016). The study was conducted by using water, ethanol and 50% ethanol as solvents extraction by applying cold maceration and Soxhlet techniques. However, the study found that 50% ethanolic extract of *O. aristatus* exhibited the highest extraction yield, which was 17.41% when cold maceration techniques were used. However, pure ethanol and 50% ethanol did not show any differences in percentage yield of extract when Soxhlet techniques were used, which were 14.32% and 14.21%, respectively. This might be due to the exposed plant material at high temperatures for a long time in the Soxhlet technique. Then, both techniques and all solvents were identified for their phenolic content and antioxidant activity. The results revealed that 50% ethanol by using cold maceration techniques had the highest phenolic content which also caused the high antioxidant activity. These findings had explained that the addition of water to ethanol will increase the extract yield since polar and non-polar components were extracted together. Nevertheless, extraction methods for *O. aristatus* were different, and the variety of solvent polarities may not be the only main factor which controls the yield of extracts. But, the combination of solvent polarities was also a factor to extract a high yield of polar bioactive compounds.

Followed from previous study, study by Pang and friends in 2017 where compared the microwave-assisted extraction (MAE) and UAE techniques, including the influence of various solvents to obtain high yield of polyphenols from *O. aristatus* leaves. The solvents used in this experiment were similar to the previous study. The result showed that a binary solvent system gave a wide range of polarity bioactive compounds as compared to pure solvent, hence, more polarity of bioactive compounds can be extracted. This study found the optimum condition to extract by using MAE techniques at extraction time of 2 min, irradiation power at 300 W and solvent to sample ratio at 20:1, which obtained the highest yield of polyphenols (RA: 32.45 mg RA/g DW; sinensetin 261.15 µg Sin/g DW; and eupatorin 2.27 mg Eup/g DW) from *O. aristatus* leaves. However, UAE methods were still the best techniques and obtained the highest yield of RA at 38.70±0.06 mg RA/g DW by using 70% aqueous methanol as compared to MAE techniques.

See et al. (2016) utilised the UAE and MAE techniques for the extraction of bioactive compounds from *O. aristatus* leaves. In the study, improvement in the extraction yield contributed by the UAE and MAE techniques was compared with the conventional Soxhlet extraction techniques. The solvent used was 70% ethanol for all types of extraction techniques based on the literature review. Scanning electron microscopy (SEM) analysis of the extracted sample by the UAE and MAE techniques induced significant disruption of the glandular trichomes structure, which was the main site for the biosynthesis of plant's secondary metabolites. Both techniques caused improvement in the diffusion of bioactive compounds which resulted in about 86% of the total extraction yield quantified by the conventional soxhlet extraction. Therefore, extraction performance on structures of leaves influenced the extraction of high yield of bioactive compounds in shorter time like the MAE and UAE techniques besides the solvents used.

Finally, SFE techniques by using CO₂ was employed to extract *O. aristatus* with full factorial design to determine the optimum extraction parameters such as temperature, pressure and time.

The full factorial design was used to optimise the extraction parameters. The findings exhibited that the yield of extract was time and pressure-dependent, and thus, concluded that the percentage yield increased significantly with increasing pressure and time ($p < 0.05$). Moderate pressure (31.1 MPa) and temperature (60C) for 60 min were recorded as the optimum extraction parameters by these researchers. FTIR analysis of the extract with prominent and broad signal indicated the presence of hydroxyl groups which concluded that this extract was rich with phenolic groups (Al-Suede et al., 2014).

A recent study that used *O. aristatus* leaves by employing SFE techniques were done by Mohamed et al. (2018). A preliminary study was first done by applying cold maceration techniques to obtain the best solvent used for SFE techniques later. The results indicated that 50% aqueous ethanol as the best solvent with the highest value result in total yield (4.64±0.02%), total phenolic content (3.42±0.08 mg GAE/g) and total flavonoids content (4.7±0.14 mg CAE/g) including IC₅₀ value for DPPH (2,2-diphenyl-1-picryl-hydrazyl-hydrate) assay was recorded at 0.625 µg/mL as compared to different concentrations of methanol solvent. Qualitative detection of polyphenols (RA, sinensetin and eupatorin) was positively detected between 8 min –21 min by using HPLC after the extract was collected at 120 min. In conclusion, the result showed positive result and CO₂ became more effective after using binary solvent system or co-solvent to extract high polar bioactive compounds. Therefore, the result obtained from this study may be further investigated by finding the optimisation condition of SFE techniques with 50% aqueous ethanol to extract a high yield of polyphenols from *O. aristatus*.

The summary table of *O. aristatus* plant regarding extraction techniques and effects of solvents used to extract bioactive compounds are shown in Table 4.

5.2. E. Longifolia (Tongkat ali)

E. longifolia extraction was mostly done by using the maceration technique that was similar to the percolation, diffusion and decoction methods, which were grouped in conventional extraction method. To the best of our knowledge, a study by Farouk and Benafri in (2007) explored the antibacterial activity of *E. longifolia* plant. In this experiment, leaves, stem, and roots were extracted separately with different extraction solvent which are methanol, ethanol, acetone and aqueous water, by using maceration techniques. The results revealed that all parts of the plant that used alcoholic and acetone extract, except the roots, had potential as antibacterial agents against Gram-positive bacteria and Gram-negative bacteria. Water was chosen as the best solvent for extract *E. longifolia* roots as mentioned in the Malaysian standard (MS 2409:2011) due to the high content of the major compound, which is eurycomanone. In this experiment, leaves and stem of *E. longifolia* prefer alcoholic and acetone solvents to extract several bioactive compounds to act as an agent for antimicrobial due to their efficacy against bacteria.

Furthermore, different parts of plants from Kuala Neniang, Taman Negara, Pahang, Malaysia were collected to determine their phytochemical and biological activity (Ismail et al., 2008). Stem and leaves of *E. longifolia* were soaked with dichloromethane and methanol successively similar to other plants. Then, the plants were screened for the presence of alkaloids and flavonoids. In the case of *E. longifolia* plant, the stem consisted of flavonoids but not alkaloids and vice versa for leaves of *E. longifolia*. Since this plant consisted less amount of flavonoids and alkaloids, the results did not give high data in free radical scavenging activity and antimicrobial activity as compared to the other plants. This was because both compounds worked together to give an effect in a therapeutic activity, such as antioxidant, antimicrobial, anticancer

Table 4A summary of study for *O. aristatus*, *E. longifolia* and *A. paniculata*.

Herbal Plant	Part plant	Techniques	Solvent used	Bioactive compound	Biological Activity	References
<i>O. aristatus</i>	Leaf	Maceration	Absolute Methanol, 50% Methanol, Water, and 70% Acetone	Sinensetin, SEN Eupatorin Rosmarinic Acid, RA 3'-hydroxy-5,6,7, 4'-tetramethoxyflavone, TMF	NR	Akowuah, 2015
		Maceration		SEN RA	Antioxidant activity	Akowuah and Zhari, 2010
		Maceration	100% Methanol, 50% Methanol, 100% Acetone, 70% Acetone, 100% Ethanol, 50% Ethanol, Chloroform and Water	Caffeic acid RA	NR	Hossain and Ismail, 2009
	Whole plant	Maceration	(25%, 50%, 75%, 100%) Methanol and Water	RA	Antimicrobial activity Antioxidant activity	Ho et al., 2010
		Solid-Liquid Extraction	Water, Ethyl Acetate, Hexane and Ethanol	RA SEN Eupatorin	NR	Razak et al., 2012
	NR Leaves	Reflux	(0-100)% Ethanol	RA	NR	Lau et al., 2014
		Maceration	100% Methanol, 50% Methanol, 100% Ethanol, 50% Ethanol and Water	RA Eupatorin	Antioxidant activity	Saidan et al., 2015
		Soxhlet		Protein Glycosaponin Polysaccharide	Cytotoxicity activity	
		Reflux	100% Ethanol, 50% Ethanol and Water	RA SEN Eupatorin	Antioxidant activity	Mansor et al., 2016
		Cold Maceration	Water, Absolute Ethanol and 50% Ethanol	RA	Antioxidant activity	Kamarudin et al., 2016
		Soxhlet	Absolute Methanol, 50% Methanol, 70% Methanol,	RA SEN Eupatorin	NR	Pang et al., 2015 Pang et al., 2015
		Ultrasound-assisted extraction, UAE	Isopropanol, 50% Isopropanol, 70% Isopropanol and Water	Eupatorin		Pang et al., 2017
	Leaf	Microwave-assisted extraction, MAE				Pang et al., 2017
UAE		70% Ethanol	3'-hydroxy-5,6,7, 4'-tetramethoxyflavone SEN	NR	See et al., 2016	
MAE						
Soxhlet		Carbon dioxide, CO ₂	Phenolic group	Antioxidant activity Anticancer activity	Al-Suede et al., 2014	
Supercritical Fluid Extraction, SFE		Water, (25%, 50%, 75%, 100%) Aqueous Ethanol, (25%, 50%, 75%, 100%) Aqueous Methanol	RA SEN Eupatorin	Antioxidant activity	Mohamed et al., 2018	
<i>E. longifolia</i>	Leaf Stem Roots	Maceration	Methanol Ethanol Acetone Aqueous water	NR	Antibacterial activity	Farouk and Benafri, 2007
			Dichloromethane Methanol	NR	Antioxidant activity Antibacterial activity	Ismail et al., 2008
			70% Acetone 70% Ethanol	NR	Aphrodisiac activity	Andrianto et al., 2009
	Stem Bark	Soxhlet	Methanol Ethanol	13 α (21)-epoxyeurycomanone (EP)	Aphrodisiac activity	Chan et al., 2010

Table 4 (continued)

Herbal Plant	Part plant	Techniques	Solvent used	Bioactive compound	Biological Activity	References
	Roots		Acetone Mixture of water and organic solvent	Eurycomanone (EN) 13 α ,21-dihydroeurycomanone (ED) Eurycomanol (EL)		
	Roots	Solid-liquid Extraction	Methanol Methanol-ethanol Ethanol Ethyl acetate Distilled water	Alkaloids Glycoside Coumarins Flavonoids	Antiplasmodial activity	Sriwilajaroen et al., 2010
	Roots	Maceration	Methanol 90% Ethanol 60% Ethanol 30% Ethanol Distilled water 95% Aqueous Methanol	NR	Anticancer activity	Rilianawati and Susi, 2011
				EN EP EDEL	Antimalarial activity	Teh et al., 2011
				EN EN EP ED EL NR	Aphrodisiac activity Anticancer activity	Low et al. 2013 Tong et al., 2015
		Soxhlet	Hexane Dichloromethane Ethanol Water		Cytotoxicity activity Antioxidant activity Antimicrobial activity Lipase inhibitory activity	Kaewpiboon et al., 2012
		Percolation	Methanol	Quassinoids Alkaloids Coumarins Squalene Triterpenoids Phenolics	Antiinflammatory activity	Tran et al., 2014
		Maceration	70% Aqueous Methanol	EN EL	Antiinflammatory activity	Hajjouli et al., 2014
	Stem Roots	Maceration	Petroleum ether Ethyl Acetate Chloroform Acetone Methanol	Phenolics Flavonoids Terpenoids Alkaloids Protein Cardiac glycosides	Antimicrobial activity	Khanam et al., 2015
	Roots	Soxhlet	Ethyl acetate Methanol	Protein Polysaccharide Phenolics	Antioxidant activity Antityrosinase activity	Hassan et al., 2015
	Stem Leaves Bark Roots Roots	Maceration	Absolute Methanol	EN	NR	Jusoh et al., 2015
			Absolute Methanol	9-hydroxycanthin-6-one 20,21,22,23-tetrahydro-23-oxoazadirone Canthin-6-one 9-O- β -glucopyranoside	Anticancer activity	Ohishi et al., 2015
		Reflux	Deionised water Absolute methanol	Glycosaponin	NR	Abirame et al., 2016
		Maceration	50% Aqueous Methanol	EN EN EP ED	Lipolytic activity	Lahrita et al. (2017)
	Stem	Maceration Maceration	70% Aqueous Ethanol Water	NR Scopoletin	Anticancer activity NR	Mulyati et al., 2017 Zakaria et al., 2017

(continued on next page)

Table 4 (continued)

Herbal Plant	Part plant	Techniques	Solvent used	Bioactive compound	Biological Activity	References	
<i>A. paniculata</i>	Leaves	Reflux Soxhlet	50% Ethanol	EN EP 14,15β-dihydroxyklaineanone	NR Anticancer activity	Norhidayah et al., 2015 Meng et al., 2014	
	Roots	Reflux	Water Methanol	EN EN EL ED Δ4,5,14-hydroxyglauucarubol 5-iso-eurycomadilacton Eurycomadilactone 13-epi-eurycomadilactone			
		Soxhlet UAE	Absolute Ethanol 95% Aqueous Ethanol	NR EN ED EL 14,15β-Dihydroxyklaineanone Δ4,5,14-hydroxyglauucarubol Eurycomaoside 2-hydroxylongilactone-4(18)-ene Longilactone Brucein E	Antifungal activity Antileukemia activity	Faisal et al., 2016 Tung et al., 2017	
			Absolute Methanol	Pasakbumin-C Eurylactone A EP 7-methoxy-(9H-b-carbolin-1-il)-(E)-1-propenoic acid (7-MCPA) 9-methoxycanthin-6-one 9-hydroxycanthin-6-one 7-MCPA	NR	Nhiem et al., 2015	
	Roots	UAE		EN ED EP Eurylactone E, G and F Eurycomalide D and E Longilactone 2-dihydro-18-dedihyrolongilactone 14,15β-dihydroxyklaineanone 5α,14β,15β-trihydroxyklaineanone Protein	Antiinflammatory activity Antiinflammatory activity	Hai Dang et al., 2016 Ngoc et al., 2016	
		MAE	Ultrapure water Methanol	2-Hexadecanol 3,5-Dimethoxy-4-hydroxyphenylacetic acid Carbazole 2-Methylhexanol Butyrolactone Nonanal Acetic acid 3-methylbutanoic acid 2 (5H)-Furanone	NR NR	Elhag et al., 2019 Najmuldeen et al., 2017	
		SFE		Ethanol Water Ethanol Methanol Acetone Acetic acid Distilled water	NR	Kumoro and Hasan, 2008	
	Whole plant	Maceration			NR	Antioxidant activity	Phansawan and Pongbangpho, 2007

Table 4 (continued)

Herbal Plant	Part plant	Techniques	Solvent used	Bioactive compound	Biological Activity	References
	Aerial part	Reflux	Ethanol (0-100) %	Andrographolide, AP	Antihyperglycemic activity	Ahmad et al., 2007
	Leaves	Maceration	Distilled water	NR	Antifungal activity	Siva, 2008
		Soxhlet	Ethanol Acetone n-Hexane Petroleum Ether Dichloromethane Ethyl Acetate Chloroform Acetone (100%, 70%) Ethanol (100%, 70%, 50%, 25%) Methanol (100%, 75%, 50%, 25%) Water	AP Deoxyandrographolide	NR	Kumoro et al., 2009
	Whole plant		Chloroform Methanol Ethanol	AP	NR	Misra et al., 2009
	Stem		Petroleum Ether	Tannin	Molluscicidal activity	Tanwer and Vijayvergia (2010)
	Leaves		Benzene	Flavonoids		
	Roots		Chloroform	Alkaloid		
			Ethanol	Steroid		
			Water	Phenolic		
	Leaves	Soxhlet	Methanol	NR	Antimalarial activity	Kuppusamy and Murugan, 2010
	Roots		Ethanol		Antioxidant activity	Saranya et al., 2010
	Leaves	Serial extraction	Petroleum Ether Ethyl Acetate Ethanol Hydro-alcohol	AP	Antiulcer activity	
		Soxhlet	Chloroform Methanol Water Petroleum Ether	AP Deoxyandrographolide Neoandrographolide 14-deoxy-11,12-didehydroandrographolide	Antimicrobial activity Antioxidant activity Antidiabetic activity Antipyretic activity	Das and Srivastav, 2014
		Reflux	Ethanol Methanol Ethyl acetate Petroleum Ether Acetone Dichloromethane	AP	NR	Jadhao and Thorat, 2014
	Whole plant	MAE	Aqueous Methanol (0-100)%	AP Dehydroandrographolide	NR	Chen et al., 2007
	Aerial part	MAE	Chloroform: Water (0-100)%	AP	Antioxidant activity	Vasu et al., 2010
	Leaves	Soxhlet				
		Cold percolation	Hexane	AP	NR	Trivedi et al., 2011
		Hot Maceration	Chloroform	Neoandrographolide		
		UAE	Ethyl Acetate			
		MAE	Ethanol			
	Leaves	Reflux	Aqueous Ethanol (0-100) %	AP Dehydroandrographolide	NR	Chua et al., 2019
	Stem			Saponin		
	Leaves	SFE	Water Ethanol Ethanol:Water	AP	NR	Rubi et al., 2019

*NR indicates not reported.

and others, which can be proven by the previous study (Farouk & Benafri, 2007).

Next, a study conducted by Andrianto and co-worker in (2009) investigated the effects of *E. longifolia* roots on growth and production of testosterone levels in a male chicken. The powdered roots were extracted by using 70% acetone and 70% ethanol as extraction solvent via maceration techniques. The results indicated 70% acetone spot on a TLC plate was larger as compared to 70% ethanol. Although, the total yield crude extract of 70% ethanol was higher with data at 0.1358 g and 70% acetone had only 0.0934 g. Besides, phytochemistry test was done to detect the presence of secondary metabolites in *E. longifolia* 70% acetone extract. The crude extract only showed the presence of alkaloid, saponin and steroid metabolites. However, the result on the male chicken did not show any increase in the concentration of testosterone levels after treatment with acetone extract of *E. longifolia* as compared to the control. In conclusion, the acetone extract does not have aphrodisiac activity even though there is the presence of steroids in the extract.

In another study, Chan et al. (2010) determined which polar organic solvent was able to extract quassinoids from *E. longifolia* roots, bark and stem. The polar organic solvents used in this experiment were water-soluble, which included methanol, ethanol and acetone or a mixture of water and organic solvents. The sample was extracted by using soxhlet techniques for 6 h to 8 h at a temperature adjusted within 50 °C to 70 °C. The result indicated methanol as the best solvent to extract quassinoids (13 α (21)-epoxyeurycomanone, eurycomanone, 13 α ,21-dihydroeurycomanone and eurycomanol) bioactive compounds which were analysed by HPLC. In addition, increasing the dosage of methanol extract resulted in increased sperm counts of male rats. This revealed methanol as the best solvent which consisted high yield of bioactive compounds, and able to increase the testosterone levels and the male sperm counts.

A study by Sriwilajjaroen et al. (2010) determined the antiplasmodial effect of *Brucea javanica* (L.) Merr fruits and roots of *E. longifolia* against *Plasmodium falciparum*. Both plant samples were extracted by using solid-liquid extraction techniques with extraction solvents, such as methanol, methanol-ethanol, ethanol, ethyl acetate and distilled water. The result indicated that a mixture of methanol-ethanol gave a total yield of crude extract at 58.93 g for *E. longifolia* roots and 125.77 g for *Brucea javanica* fruits. Focusing on the *E. longifolia* extract, the results revealed high antiplasmodial activity in ethanol and methanol-ethanol extract with a similar pattern of TLC plate whereby the presence of bioactive compounds was identified, including alkaloids, antioxidants, glycoside, coumarins and flavonoids. This showed the binary solvent can be the best solvent to extract a wide variety of bioactive compounds from *E. longifolia* roots.

Furthermore, a study by Rilianawati (2011) extracted roots of *E. longifolia* with methanol, 90% ethanol, 60% ethanol, 30% ethanol and distilled water by applying maceration techniques. Then, the crude extract was for cytotoxicity activity against normal and cervix cancer cell line. The results indicated that methanol extract gave high inhibition effect on cervix cancer cell line at IC₅₀ 24.14 ppm, which was lower than 50 ppm as compared to other extracts. However, there was no effect on a normal cell line for all types of extraction solvents. Therefore, further research regarding methanol extract on cancer cell line was required. This was due to the previous study on their achievement on cytotoxicity activity which may reduce side effect that occurred during chemotherapy by determining the active component that may become an agent for anticancer from methanol extract of *E. longifolia* roots (Itokawa et al., 1992; Jiwajinda et al., 2002).

Teh et al. (2011) macerated the powdered roots of *E. longifolia* by using 95% aqueous methanol for 6 d at 60 °C. This method was also followed by Tong et al. (2015) and Low et al. (2013)

who studied the effect of eurycomanone, major quassinoids in *E. longifolia* that were obtained from the extraction, isolation, and purification components from roots according to the method by Teh et al. (2011) in testosterone steroidogenesis and spermatogenesis. The results showed that eurycomanone had potential in increasing testosterone levels. Meanwhile, Tong et al. (2015) studied the effect of standardised quassinoids (contained 40% of the total quassinoids from *E. longifolia*) extracted on LNCAP human prostate cancer cells. The HPLC result of this standardised extract found about 32.16% quassinoids including eurycomanone, epoxyeurycomanone, eurycomanol and 13,21-dihydroeurycomanone, inhibited the LNCaP cell growth at IC₅₀ value of 5.97 μ g/mL. Therefore, these experiments showed that methanol was the best solvent to extract quassinoids and gave positive effects on different biological activities. Further studies are needed to back up the study before being proven as the best-chosen solvent to be used to extract *E. longifolia* plant.

52 types of Thai plants including *E. longifolia* roots, were extracted by using soxhlet techniques for 8 h with hexane, dichloromethane, ethanol and water sequentially (Kaewpiboon et al., 2012). Then, these crude extracts were screened for their cytotoxicity against four cell lines (human lung (A549), breast (MDA-MB-231), cervical (KB3-1) and colon (SW480) cancers), antioxidant activity, lipase inhibitory activity and antimicrobial activity through in-vitro study. In this experiment, the result for *E. longifolia* roots showed water extract gave the highest yield of extract at 1.9% followed by, dichloromethane (0.5%) and ethanol (0.3%). Hexane solvent acted as defatting this *E. longifolia* roots, and thus, the yield of hexane extract was 0%. Dichloromethane and ethanol extract of this plant were also exerted strongly in cytotoxicity activity against cancer cell lines with the other three plant species. Similar positive results were obtained for antioxidant activity, lipase inhibitory activity and antimicrobial activity for polar solvent extracts (water and ethanol) for *E. longifolia* roots. This might be due to the presence of several metabolites such as phenolics compounds, flavonoids, alkaloids and others in polar solvents.

Next, a study by Tran et al. (2014) also used 60L methanol as a solvent for extraction and percolated the roots of *E. longifolia*. Tran et al. studied on isolated compounds which were about 28 components from the extract and investigated their acting as NF- κ B inhibitors by using HEK293/NF- κ B-luc cells that derived from the human embryonic kidney. Previously, a study by Hajjouli et al. (2014) also focused on NF- κ B. But, the powdered roots of *E. longifolia* were macerated with 70% aqueous methanol for 8 h at 40 °C. Then, the crude extract underwent fractionation, isolation, and purification of components to obtain eurycomanone and eurycomanol to study on the K562 and Jurkat cells, or also known as leukaemia cells. The results revealed that only eurycomanone inhibited NF- κ B and induced the MAPK pathway by TNF- α without affecting the healthy cells, but not eurycomanol compounds.

A study conducted by Khanam et al. (2015) found suitable solvents for the extraction of bioactive components from *E. longifolia* stems and roots. The stems and root of *E. longifolia* were extracted by using the following five solvents; petroleum ether, ethyl acetate, chloroform, acetone and methanol for 24 h at 40 °C in a water bath. Exceptionally, the extract of *E. longifolia* that used methanol, ethyl acetate and chloroform indicated as a good source for isolate different classes of compounds for both stems and roots. But, not for petroleum ether extract which revealed the lowest number of phytochemicals. Since the major compound of *E. longifolia* was eurycomanone which was a derivative of quassinoids from terpenoids group, the results revealed all solvent extracts except acetone, showed the presence of terpenoids via Salkowski's Test for both stems and roots. However, in the case of roots, the methanol solvent was chosen as the best source to extract a variety of phytochemicals.

On the other hand, Hassan et al. (2015) investigated the effects of varying solvent polarities on the total protein and total polysaccharides concentration in *E. longifolia* extract. The results indicated that protein and polysaccharide contents were higher in ethyl acetate extract as compared to methanol extract. Additionally, the total phenolic content was also investigated between these solvents and the results were the same as before. This might be due to the polarity of solvents (polar aprotic solvents) which was able to extract polar and non-polar compounds but, non-polar solvents were only able to extract non-polar compounds.

In another study, the leaves, stem, bark, and roots of *E. longifolia* were extracted by maceration techniques by using absolute methanol as the extraction solvents. This experiment was conducted by Jusoh et al. (2015) to compare the eurycomanone content in different plant parts and at different plantation locations. The experiment also determined the effect of agro-ecological on favourable growth. HPLC results showed that roots had the highest eurycomanone content as compared to other parts of the plant and the shaded area was the most suitable place for *E. longifolia* growth with high eurycomanone content. A similar method has been used for extraction by Ohishi et al. (2015) that used absolute methanol as extraction solvent and left roots overnight at room temperature. Then, followed by fractionation, isolation and purification of components (9-hydroxycanthin-6-one, 20,21,22,23-tetrahydro-23-oxoazadirone and canthin-6-one 9-O- β -glucopyranoside) from *E. longifolia* to study on the colon cancer cells. This showed that methanol was the best solvent to extract a high yield of quassinoids from *E. longifolia* roots.

In addition, Abirame et al. (2016) experiment investigated the effects of solvents on the extraction of glycosaponin and eurycomanone. The solvents selected for this study were deionised water and absolute methanol. Reflux method was used for the extraction of *E. longifolia* components especially glycosaponin and eurycomanone. Based on the findings, the aqueous extract produces more glycosaponin and eurycomanone compounds than methanolic extract. This finding showed that water was the best solvent for both compound extraction and eurycomanone was a polar compound.

Followed by the most recent research paper in 2017 by Lahrita et al. and Mulyati et al., whereby both used maceration techniques as the extraction method. Lahrita et al. (2017) by using 50% methanol as the solvent for extraction and then underwent isolation to obtain eurycomanone, 13 β ,21-epoxyeurycomanone and 13 β ,21-dihydroeurycomanone for studies on the lipolytic activity. Meanwhile, Mulyati et al. (2017) by using 70% ethanol as the solvent for extraction and obtained about 2.92% total yield less as compared to Lahrita et al. (2017) around 3.42%. This recent study showed that binary solvent gave high total crude extract and high yield of bioactive compounds as compared to pure solvents.

Then, the effects of solvents on *E. longifolia* stem and leaves were carried out by Zakaria et al. (2017). The study was conducted by using two different solvents (water and ethanol) and two different extractions technique (reflux and maceration) for both stems and leaves. The findings of this study showed that ethanol was the best solvent for extract leaves due to the high content of phospholipid, flavonoids and saponin. Meanwhile, total protein content and total phenolic content both high in leaves when water was used as extraction solvent even though the stem contained more phenolic compounds in general. Maceration was the best method when water was used as a solvent for extraction overnight at 60 °C as compared to reflux. This showed that temperature cause degradation of bioactive compounds. To concludes, there was a variety of factors that may affect the content and yield of the bioactive component of extracts.

On the other hand, 41 *E. longifolia*-based products which were registered or unregistered under NPCB, Malaysia were studied by

Mohamed et al. (2015). These products were compared with the standardised water extract of *E. longifolia* extracted under reflux for 5 h. The sample was analysed by using HPLC to study the eurycomanone content. A study by Meng et al. (2014) also extracts used reflux techniques for 2 h with absolute methanol. The extract was isolated to obtain seven components including four new quassinoids compounds, and characterised by using 1D and 2D NMR along with single-crystal X-ray diffraction. But, the extraction conducted by Faisal et al. in 2016 used soxhlet extraction (absolute ethanol as solvent, 60 °C – 65 °C and 24 h). The extract obtained about 33% total yield and later was used for the antifungal study. Although, all studies previously used different techniques of extraction polar solvent was chosen as extraction solvent to extract a high yield of quassinoids or eurycomanone from *E. longifolia* roots based on previous studies.

Study by Tung et al. (2017), Nhiem et al. (2015), Hai Dang et al. (2016), Ngoc et al. (2016) and Park et al. (2014) extracted *E. longifolia* by using ultrasound-assisted extraction, UAE techniques due to the increasing interest in the modern and efficient technique. These experiments used an ultrasonic water bath. Only Tung and co-worker used 95% ethanol as a solvent for extraction, the others used absolute methanol. This was because methanol solvent was chosen as the best solvent to extract a high yield of crude extract and eurycomanone based on previous studies that were mentioned before. Tung et al. and Park et al. focussed studies on the anticancer activity and founds that the result active component (eurycomanone) had the potential for leukaemia, breast cancer, human lung, and cervical cancer cells treatment, respectively. But, the other researcher studied on the antiinflammatory activity. The most recent paper used UAE techniques was studied by Elhag et al. (2019) and for the first-time a study on optimisation, was done. The study used an ultrasonic probe with five independent variables (particle size, extraction temperature, agitation speed, amplitude, and duty cycle) to find the optimum conditions for efficient protein recovery. The solvent used for extraction was ultrapure water which followed the Malaysian standard (MS 2409:2011).

Next, a microwave-assisted extraction (MAE) study by Najmuldeen et al. (2017) characterised essential oil from *E. longifolia* extraction. The components of essential oil from extraction were analysed by using gas chromatography and mass chromatography (GCMS) and were found to have similar results with previous publication from Islam et al. (2006) and Purwantiningsih and Chan (2011). Finally, the extraction which used SFE only was studied by Kumoro and Hasan (2008). However, his study extracted various Malaysian herbs including *E. longifolia* to achieve the objective in the innovation of extraction methods parallel with enhancing the economic value of Malaysian herbs in global industries. Various co-solvents were used to extract polar bioactive compounds such as ethanol and water as modifiers and then increased the efficiency of extraction. Based on previous studies, these showed that to extract a high yield of polar bioactive compounds, the polar solvent was needed, and the binary system can apply to increase the yield of targeted bioactive compound.

The summary of studies on *E. longifolia* plants regarding extraction techniques and solvent used to extract a high yield of crude extract including major compounds, eurycomanone is shown in Table 4.

5.3. A. *Paniculata* (*Hempedu bumi*)

A study by Phansawan and Pongbangpho (2007) investigated five medicinal plants including *A. paniculata* by varying the polarity of extraction solvents and study the antioxidant activity. The solvent used in this experiment were ethanol, methanol, acetone, acetic acid and distilled water. Maceration techniques were

applied for 24 h and maintained at room temperature. Ethanol was chosen as the best solvent for extraction of all medicinal plants due to the highest recorded antioxidant activity. The result was followed by acetone, methanol, distilled water and acetic acid as extraction solvent for these medicinal plants (*Pueraria mirifica*, *Stevia rebaudiana* Bertoni, *Curcuma longa* Linn, *A. paniculata* and *Cassia alata* Linn). Focusing on *A. paniculata*, the results obtained high antioxidant activity at 0.77 ± 0.13 μmol of Trolox/ mg of ethanol crude extraction, followed by distilled water, acetic acid, and methanol.

Meanwhile, a study by Ahmad et al. (2007) determined the anti-hyperglycemic effects of different extraction solvents in normal and streptozotocin-induced diabetic rats. Aerial parts of *A. paniculata* were extracted with different concentration of ethanol (20%, 50%, and 95%) and distilled water by using reflux techniques at 40 °C for 3 days. The biomarker of *A. paniculata*, andrographolide was determined by using HPLC-UV analysis in each solvent extraction. The result showed 95% of ethanol and 50% ethanol had the highest amount of andrographolide compounds with 25.8 and 19.4 mg/g dry weight extract, respectively. However, both ethanol extracts did not show any antihyperglycemic activity, whereby the result revealed that this extract reduced the fasting blood glucose and insulin level in normal and diabetic rats after 14 days as compared to pre-treatment levels. Thus, this concludes that both extracts have a similar effect as metformin.

In 2008, a study conducted by Siva extracted leaves of 20 plants including *A. paniculata* by using maceration techniques to determine the antifungal effects against *Fusarium oxysporum*. The selected solvents for this study were water, ethanol, and acetone, and the results showed that at 50% concentration of all extracted plants was the most effective in reducing the growth of *Fusarium oxysporum*. Four among the 20 plants, namely *Adhatoda vasica*, *Jatropha curcas*, *Sapindus emarginatus* and *Vitex negundo* showed the highest inhibition against fungal. In addition, 100% inhibition occurred when treating with 40% of water extract *A. vasica* plant. Focusing on *A. paniculata* plant, the highest inhibition was at 84% of ethanol extract followed by water and acetone extract. Therefore, *A. paniculata* plant also has an antifungal effect and maybe in future the study can investigate which solvent and concentration shows 100% inhibitions of *Fusarium oxysporum*.

Next, a study by Kumoro et al. (2009) investigated the effect of varying solvent properties on the Soxhlet extraction of diterpenoid lactones from *A. paniculata* leaves. 16 different solvents were used which were n-hexane, petroleum ether, dichloromethane, ethyl acetate, chloroform, acetone 100%, acetone 70%, ethanol 100%, ethanol 70%, ethanol 50%, ethanol 25%, methanol 100%, methanol 75%, methanol 50%, methanol 25%, and water. The study found that methanol was the best solvent based on the yield of extract, and andrographolide and deoxyandrographolide contents. Also, ethanol and aqueous acetone were able to extract andrographolide but at a lower yield as compared to methanol solvents.

Similar extraction techniques were done by Misra et al. (2009) extracted the whole plant of *A. paniculata* with chloroform, methanol and ethanol for 8 h. The objective of the study was to improve HPTLC-UV method in the quantification of andrographolide constituents from different *A. paniculata* extracts. The results indicated methanol as the best solvent for extract andrographolide constituents with percentage mean at 0.178%, which was similar to a study before, followed by ethanol and chloroform extract at 0.166% and 0.045%, respectively. The selected extraction solvent was further investigated with suitable binary mixture for a mobile phase in HPTLC separation of andrographolide compounds.

In another study, Tanwer and Vijayvergia (2010) applied soxhlet techniques to evaluate the phytochemical and molluscicidal activities of *A. paniculata* stem, leaf and roots. The solvents used in the study were petroleum ether, benzene, chloroform, ethanol,

and water to determine the presence of various compounds in each extract. Maximum yield at 3.134% was obtained from water extract followed by ethanol, benzene, chloroform, and petroleum ether. Presence of tannin was found in all extract except in petroleum ether. Meanwhile, flavonoids and alkaloids were found in chloroform, ethanol, and water extract. Steroids were only obtained in chloroform and ethanol extract. In conclusion, all compounds are able to be obtained in ethanol extract. However, the ethanol extract was surprisingly toxic to snail *Lymnaea acuminata*.

Soxhlet techniques were also been used to extract leaves and roots of *A. paniculata* by using ethanol and methanol as extraction solvents (Kuppusamy & Murugan, 2010). This study determined the effects of both extracts on growth, development, and reproduction of malarial vector *Anopheles stephensi* Liston. The result showed that ethanol extract was able to inhibit the emergence of larvae at 88.60% when treated with 35 ppm after 8 days. Meanwhile, methanol extract obtained lower emergence inhibition than ethanol extract at 85.25%. This result was similar to a study by Pushpalatha & Muthukrishnan (1995).

Saranya et al. (2010) aimed a suitable solvent that contained a high yield of andrographolide compounds and then an extract possessed high antioxidant and antiulcer activities. The leaves of *A. paniculata* were subjected to a serial extraction and set temperature within 60 °C – 80 °C with the following order of solvent polarity: petroleum ether, ethyl acetate, ethanol, and hydro alcohol. The result revealed hydro alcohol fractions indicated significant free radical scavenging activity and was able to influence antiulcer activity due to the ability in preventing the formation, and the negative effects of toxic oxygen free radical on gastric mucosa. Thus, this study suggested further investigations on gastro protective trait of *A. paniculata*.

Then, Das and Srivastav (2014) studied the antimicrobial activity of AP leaf extract by using different extraction solvents such as chloroform, methanol, petroleum ether, and water against bacterial strains like *Bacillus subtilis*, *Escherichia coli* by disc diffusion method. Besides, the presence of phytochemicals in different extraction solvent was carried out, including antioxidant activity, antipyretic activity and antidiabetic activity. The result revealed that methanolic extract from soxhlet techniques of AP leaf showed maximum inhibitory action against *Escherichia coli* and *Bacillus subtilis*. The similar methanol extract showed high antioxidant activity with 97.2% inhibition of free radical and decreasing the blood glucose level in the antidiabetic activity. However, chloroform and water extract exhibited the highest antipyretic activity (reduced elevated body temperature) in mice after a two-h treatment. This showed that the methanol solvent was able to act as an antimicrobial agent and antidiabetic agent due to the high presence of phytochemical as compared to other extraction solvent.

A study conducted by Jadhao and Thorat (2014) focused on the effect of different solvents, such as ethanol, methanol, acetone, ethyl acetate, petroleum ether, and Dichloromethane on total yield extraction. The experiments were done by using reflux techniques and the results revealed that methanol extraction gave the highest extraction yield as compared to other solvents. High yield of major constituents, andrographolide was obtained when extracted with polar solvents as compared to non-polar solvents, especially methanol although solubility parameters ethanol and acetone were closer to andrographolide compounds. Meanwhile, water extract contained less andrographolide content due to the hydrolysis and thermal degradation that might affects the results. To conclude, the polar solvent (methanol) was the best solvent to extract andrographolide compounds as compared to other solvents which were also supported by Misra et al. (2009).

Conventional extraction of *A. paniculata* to extract primary bioactive compound, andrographolide was performed by macer-

ation, soxhlet, and reflux as above. A study by Chen et al. (2007) carried out MAE techniques was coupled on-line with HPLC to quantify andrographolide and dehydroandrographolide from the whole plant of *A. paniculata*. Optimisation of this technique was done by including several parameters like varying the concentration of methanol in water, microwave power, extraction time, extraction solvent flow-rate and amount of sample. The optimised conditions for MAE extraction were found at 60% aqueous methanol, 80 W, 6 min, 1.0 mL/min, and 10 mg due to the high presence of andrographolide and dehydroandrographolide constituents. These obtained data were compared with ultrasonic extraction techniques (40% aqueous methanol, 30 min, 500 mg), and the results indicated MAE techniques that were on-line coupled with HPLC required shorter time and less amount of sample to extract both bioactive compounds, andrographolide (1.13%), and dehydroandrographolide (0.65%) from *A. paniculata*.

A study conducted by Vasu et al. (2010) compared the conventional techniques (soxhlet techniques) and modern techniques (MAE) by using chloroform and a mixture of chloroform and distilled water as extraction solvent, respectively. Both techniques and solvents were analysed on their major compounds by using UV, HPTLC, and HNMR. Then, antioxidant activity via (2,2'-azino-bis (3-ethylbenzo-thiazoline-6-sulphonic acid) diammonium salt), ABTS assay; DPPH assay, nitric oxide radical scavenging activity; lipid peroxidation inhibitory assay; and scavenging superoxide radical by alkaline DMSO method were done. The yield of andrographolide compounds for conventional techniques were obtained at 0.4452% and MAE techniques provided a 0.589% yield. However, extracted samples in chloroform only under the same parameter of MAE techniques the yield obtained was 0.152%. This showed that binary solvent was more effective in the extraction of andrographolide as compared to the pure solvent. Besides, MAE techniques obtained higher yield as compared to the conventional techniques within a shorter time and was able to reduce thermal effects on targeted bioactive compounds.

A study conducted by Trivedi et al. (2011) identified high yield of andrographolide and neo-andrographolide from leaves of *A. paniculata* by applying different extraction techniques (cold percolation, hot maceration, UAE and MAE) and different solvent polarities (hexane, chloroform, ethyl acetate, ethanol, methanol and surfactant). It is shown that methanol solvent as the best solvent to extract both major compounds in *A. paniculata* leaves. This was because both bioactive compounds were hydrophobic compounds and more preferred extract with an alcohol solvent. Modern techniques such as UAE and MAE techniques were preferred more than cold percolation and hot maceration due to the shorter extraction time. In addition, mostly organic solvents were not suitable for microwave effects. Therefore, UAE techniques with methanol solvents were chosen for high yield extraction of andrographolide and neo-andrographolide bioactive compounds.

Recently a study conducted by Chua and co-worker in 2019 aimed at a rapid and simple phytochemical profile of *A. paniculata*. The study applied reflux techniques to determine the yield of a major compound and total saponin content, including the total yield of the crude extract by using different concentration of ethanol (0–100) % in water as extraction solvent. The result indicated 0% ethanol exhibited the highest total yield of the crude extract with a result in 15.7%. But, total saponin content was increased as the concentration of ethanol increase. This showed that ethanol had an important role to extract saponin compounds. The yield of major compounds such as andrographolide and dehydroandrographolide was determined by using LC-DAD MS/MS analysis and the result revealed that both bioactive compounds increased with the concentration of ethanol.

In the same year, a study by Rubi et al. investigated the viability of using SFE techniques (CO₂- expanded liquid extraction) with different extraction solvents (water, ethanol, and a mixture of ethanol–water) of andrographolide from *A. paniculata*. The SFE techniques were then compared with conventional solid–liquid extraction to determine which solvent and techniques gave the highest yield recovery of andrographolide compounds. In this study, conventional solid–liquid extraction showed ethanol solvent gave the highest recovery of andrographolide at 21% followed by, a mixture of ethanol–water and water at 18% and 12%, respectively. Meanwhile, modern techniques gave the highest yield of andrographolide when a mixture of ethanol–water was used as solvent extraction, whereby the resulting increase was from 18% to 64%. Then this was followed by ethanol and water at 49% and 19%, respectively. Therefore, it can be concluded that the binary solvent system was better solvent to be used to extract major compounds of *A. paniculata* plant as compared to the pure solvent. In addition, modern techniques can shorten the extraction time and result high yield of bioactive compounds.

A summary of review studies on *A. paniculata* plant is shown in Table 4 with regard to the extraction techniques and solvent used.

6. Conclusion

This review article is focused on variety of traditional and modern extraction techniques that used to extract polar bioactive compounds from *O. aristatus*, *E. longifolia* and *A. paniculata*. It was prepared based on plenty of literature research. In conclusion, modern extraction techniques are the most efficient and promising way to obtain the highest yield of components including the stability of targeted compounds. The reduction use of solvent and co-solvent in modern extraction techniques helps in improving the environment health and industry application which aims a green extraction. Hence, this article will be a complete ready reference for those researchers who are further their study regarding the drug discovery and drug development from natural products.

Funding

This research was funded by This work is supported by the Ministry of Higher Education (MoHE) Malaysia grant scheme: LRGSMRUN (R.J130000.7851.4L885), FRGS (R.J130000.7851.5F344), HICOE research grant (R.J130000.7846.4J266) and Research University grant (Q.J130000.2546.18H51).

Declaration of Competing Interest

The authors declare that they have no known competing financial interests or personal relationships that could have appeared to influence the work reported in this paper.

Acknowledgement

This work is supported by the Ministry of Higher Education (MoHE) Malaysia grant scheme: LRGSMRUN (R.J130000.7851.4L885), FRGS (R.J130000.7851.5F344), HICOE research grant (R.J130000.7846.4J266) and Research University grant (Q.J130000.2546.18H51).

References

Abarca-Vargas, R., Pena Malacara, C.F., Petricevich, V.L., 2016. Characterization of Chemical Compounds with Antioxidant and Cytotoxic Activities in

- Bougainvillea X Buttiana Holttum and Standl. (var. Rose) extracts. Antioxidants. 5, 4, 45, 1–18. <https://doi.org/10.3390/antiox5040045>.
- Abirame, S., Sivakumar, K., Chua, L.S., Sarmidi, M.R., 2016. Preliminary studies on the extraction of Glycosaponins in Tongkat Ali extract. E&ES 36, (1). <https://doi.org/10.1088/1755-1315/36/1/012062> 012062.
- Abu Bakar, B.M., Salleh, F.M., Wagiran, A., 2017. Chemical Composition of *Eurycoma longifolia* (Tongkat Ali) and the Quality Control of its Herbal Medicinal Products. J. Appl. Sci. 17 (7), 324–338. <https://doi.org/10.3923/jas.2017.324.338>.
- Ahmad, F., Zaidi, M.A., Sulaiman, N., Majid, F.A.A., 2015. Issues and Challenges in the Development of the Herbal Industry in Malaysia. Proc. Perkem 10, 227–238.
- Ahmad, M., Razak, A., Akowuah, G.A., Asmawi, Z., Zhari, I., 2007. HPLC profile and antihyperglycemic effect of ethanol extracts of *Andrographis paniculata* in normal and streptozotocin-induced diabetic rats. J. Nat. Med. 61 (4), 422–429. <https://doi.org/10.1007/s11418-007-0157-4>.
- Ahmad, N., Samiulla, D.S., Teh, B.P., Zainol, M., Zolkifli, N.A., Muhammad, A., Matom, E., Zulkapli, A., Abdullah, N.R., Ismail, Z., Syed Mohamed, A.F., 2018. Bioavailability of Eurycomanone in Its Pure Form and in A Standardised *Eurycoma longifolia* Water Extract. Pharmaceutics 10 (3), 90. <https://doi.org/10.3390/pharmaceutics1003090>.
- Akowuah, G.A., Zhari, I., 2010. Effect of Extraction Temperature on Stability of Major Polyphenols and Antioxidant Activity of *Orthosiphon stamineus* Leaf. J. Herbs Spices Med Plants 16 (3–4), 160–166 <https://doi.org/10.22146/jhc.21575>.
- Akowuah, G.A., Ismail, Z., Ahmad, M., 2012. HPLC–TOF/MS Profile and Nitric Oxide Scavenging Activity of *Orthosiphon stamineus* Leaf Extracts. Asian Pacific J. Trop. Biomed. 2 (3), S1436–S1439. [https://doi.org/10.1016/S2221-1691\(12\)60432-8](https://doi.org/10.1016/S2221-1691(12)60432-8).
- Akowuah, G.A., Ismail, Z., Norhayati, I., Sadiqun, A., 2005. The Effects of Different Extraction Solvents of Varying Polarities on Polyphenols of *Orthosiphon stamineus* and Evaluation of the Free Radical Scavenging Activity. Food Chem. 93, 311–317. <https://doi.org/10.1016/j.foodchem.2004.09.028>.
- Alamgir, A.N.M., 2018. Therapeutic Use of Medicinal Plants and their Extracts: Volume 2 (Phytochemistry and Bioactive Compounds). Progress in Drug Research (Vol. 74, pp. 599). Published by Springer International Publishing AG, part of Springer Nature 2018. <https://doi.org/10.1007/978-3-319-92387-1>.
- Almatar, M., Rahmat, Z., 2014. Identifying the Developmental Stages and Optimizing the Sample Preparation for Anatomical Study of *Orthosiphon stamineus*. J. Appl. Pharmaceut. Sci. 4 (3), 66. <https://doi.org/10.7324/JAPS.2014.40314>.
- Al-Suede, F.S.R., Khadeer Ahamed, M.B., Abdul Majid, A.S., Baharetha, H.M., Hassan, L.E., Kadir, M.O.A., Nassar, Z.D., Abdul Majid, A., 2014. Optimization of Cat's Whiskers Tea (*Orthosiphon stamineus*) using Supercritical Carbon Dioxide and Selective Chemotherapeutic Potential against Prostate Cancer Cells. Evid.-Based Complement. Alternat. Med. 2014. <https://doi.org/10.1155/2014/396016>.
- Altemimi, A., Lakhssassi, N., Baharlouei, A., Watson, D.G., Lightfoot, D.A., 2017. Phytochemicals: Extraction, Isolation, and Identification of Bioactive Compounds from Plant Extracts. Plants 6 (4), 42. <https://doi.org/10.3390/plants6040042>.
- Andrianto, D., Bintang, M., Kustaman, E., Katayama, T., & Suzuki, T., 2009. Effect of *Eurycoma longifolia* Jack on growth and testosterone level in male chicken. In Proceedings of 1st Indonesia Wood Research Society 2009 Conference (pp. 230–235). Bogor, Indonesia. <https://www.researchgate.net/publication/326316888>.
- Anuradha, M., Pragyandip, P.D., Richa, K., Murthy, P.N., 2010. Evaluation of Neuropharmacological Effects of Ethanolic Extract of *Clitorea ternatea* Flowers. Pharmacologyonline. 1, 284–292.
- Azwania, N.N., 2015. A Review on the Extraction Methods Use in Medicinal Plants, Principle Strength and Limitation. Med Aromat Plants 4 (196), 2167–2174. <https://doi.org/10.4172/2167-0412.1000196>.
- Banerjee, M., Moulick, S., Bhattacharya, K.K., Parai, D., Chattopadhyay, S., Mukherjee, S.K., 2017. Attenuation of *Pseudomonas Aeruginosa* Quorum Sensing, Virulence and Biofilm Formation by Extracts of *Andrographis paniculata*. Microb. Pathog. 113, 85–93. <https://doi.org/10.1016/j.micpath.2017.10.023>.
- Basa'ar, O., Fatema, S., Alrabie, A., Mohsin, M., Farooqui, M., 2017. Supercritical Carbon Dioxide Extraction of *Triognella foenum graecum* Linn seeds: Determination of Bioactive Compounds and Pharmacological Analysis. Asian Pacific J. Trop. Biomed. 7, 12, 1085–1091. <https://doi.org/10.1016/j.fpb.2009.02.001>.
- Batkhuu, J., Hattori, K., Takano, F., Fushiya, S., Oshiman, K.I., Fujimiya, Y., 2002. Suppression of NO Production in Activated Macrophages *In Vitro* and *ex Vivo* by Neoandrographolide Isolated from *Andrographis paniculata*. Biol. Pharm. Bull. 25 (9), 1169–1174. <https://doi.org/10.1248/bpb.25.1169>.
- Bergs, D., Merz, J., Delp, A., Joehneck, M., Martin, G., Schembecker, G., 2013. A Standard Procedure for the Selection of Solvents for Natural Plant Extraction in the Early Stages of Process Development. Chem. Eng. Technol. 36 (10), 1739–1748. <https://doi.org/10.1002/CEAT.201300276>.
- Bhat, R., Karim, A.A., 2010. Tongkat Ali (*Eurycoma longifolia* Jack): A Review on its Ethnobotany and Pharmacological Importance. Fitoterapia 81 (7), 669–679. <https://doi.org/10.1016/j.fitote.2010.04.006>.
- Bimakr, M., Rahman, R.A., Taip, F.S., Adzahan, N.M., Sarker, M., Islam, Z., Ganjloo, A., 2012. Optimization of Ultrasound-Assisted Extraction of Crude Oil from Winter Melon (*Benincasa hispida*) Seed Using Response Surface Methodology and Evaluation of Its Antioxidant Activity, Total Phenolic Content and Fatty Acid Composition. Molecules 17 (10), 11748–11762. <https://doi.org/10.3390/molecules171011748>.
- Chan, K.L., Low, B.S., San Ho, D.S., 2010. Polar organic extract of *Eurycoma longifolia*. U.S. Patent Application No. 12/302,875.
- Chen, L.X., He, H., Xia, G.Y., Zhou, K.L., Qiu, F., 2014. A New Flavonoid from the Aerial Parts of *Andrographis paniculata*. Nat. Prod. Res. 28 (3), 138–143. <https://doi.org/10.1080/14786419.2013.856907>.
- Chen, Ligang, Jin, Haiyan, Ding, Lan, Zhang, Huarong, Wang, Xiupin, Wang, Ziming, Li, Juan, Qu, Chenling, Wang, Yutang, Zhang, Hanqi, 2007. On-line coupling of dynamic microwave-assisted extraction with high-performance liquid chromatography for determination of andrographolide and dehydroandrographolide in *Andrographis paniculata* Nees. J. Chromatogr. A 1140, 71–77. <https://doi.org/10.1016/j.chroma.2006.11.070>.
- Chua, L.S., Abdullah, F.I., Azlah, M.A.F., 2019. Phytochemical Profile of *Andrographis paniculata* Extract from Solvent Partition and Precipitation. J. Biolog. Active Prod. Nat. 9 (3), 238–249. <https://doi.org/10.1080/22311866.2019.1646671>.
- Chua, L.S., Latiff, N.A., Mohamad, M., 2016. Reflux Extraction and Cleanup Process by Column Chromatography for High Yield of Andrographolide Enriched Extract. J. Appl. Res. Med. Aromat. Plants 3, 64–70. <https://doi.org/10.1016/j.jarmap.2016.01.004>.
- Das, P., Srivastav, A.K., 2014. Phytochemical extraction and characterization of the leaves of *Andrographis paniculata* for its anti-bacterial, anti-oxidant, anti-pyretic and anti-diabetic activity. Int. J. Innov. Res. Sci. Eng. Technol. 3, 15176–15184. <https://doi.org/10.15680/IJRSET.2014.0308016>.
- Easmin, M.S., Sarker, M.Z.L., Ferdosh, S., Shamsudin, S.H., Yunus, K.B., Uddin, M.S., Khalil, H.A., 2015. Bioactive Compounds and Advanced Processing Technology: *Phaleria macrocarpa* (sheff.) Boerl, A Review. J. Chem. Technol. Biotechnol. 90 (6), 981–991. <https://doi.org/10.1002/jctb.4603>.
- Ekrami, S., Shamlouei, H.R., 2018. Ab Initio Study of C 20 Nanocluster Effects on Electrochemical Properties of Tetraphenylporphyrin. J. Porphyrins Pthalocyanines 22 (08), 640–645. <https://doi.org/10.1142/S1088424618500773>.
- Elhag, H.E.A., bin Sulaiman, A.Z., binti Ajit, A., 2016. A Review on the Extraction Methods of Extracts and Phytochemicals from *Eurycoma longifolia* (Tongkat Ali Jack). In The national conference for postgraduate research 2016, Universiti Malaysia Pahang, pp. 253–259. <http://umpir.um.edu.my/id/eprint/15882>.
- Elhag, H.E.A., Naila, A., Nour, A.H., Ajit, A., Sulaiman, A.Z., Abd Aziz, B., 2019. Optimization of protein yields by ultrasound assisted extraction from *Eurycoma longifolia* roots and effect of agitation speed. J. King Saud Univ.-Sci. 31 (4), 913–930. <https://doi.org/10.1016/j.jksus.2018.05.011>.
- Esther, P., Mathangi, D.C., Namasivayam, A., 2003. Free Radical Changes in Methanol Toxicity. Indian J. Physiol. Pharmacol. 47 (2), 207–211 <https://pubmed.ncbi.nlm.nih.gov/15255626>.
- Faisal, G.G., Zakaria, S.M., Najmuldeen, G.F., Al-Ani, I.M., 2016. Antifungal activity of *Eurycoma Longifolia* jack (tongkat ali) root extract. J. Int. Dent. Med. Res. 9 (1), 70 http://www.jidmr.com/journal/DENTISTRY/2016/vol9_no1/13_D16_297_Ghasak_Ghazi_Faisal.pdf.
- Farouk, A.E., Benafri, A., 2007. Antibacterial activity of *Eurycoma longifolia* Jack. Saudi Med. J. 28 (9), 1422–1424 <https://www.researchgate.net/publication/6072997>.
- Hai Dang, N., Choo, Y.Y., Tien Dat, N., Hoai Nam, N., Van Minh, C., Lee, J.H., 2016. 7-methoxy-(9h-β-carbolin-1-yl)-(e)-1-propenoic acid, a β-carboline alkaloid from *Eurycoma longifolia*, exhibits anti-inflammatory effects by activating the nrf2/heme oxygenase-1 pathway. J. Cell. Biochem. 117 (3), 659–670. <https://doi.org/10.1002/jcb.25315>.
- Hajjoui, S., Chateauvieux, S., Teiten, M.H., Orlikova, B., Schumacher, M., Dicato, M., Choo, C.Y., Diederich, M., 2014. Eurycomanone and Eurycomanol from *Eurycoma longifolia* Jack as Regulators of Signaling Pathways Involved in Proliferation Cell Death and Inflammation. Molecules 19 (9), 14649–14666. <https://doi.org/10.3390/molecules190914649>.
- Handa, S.S., Sharma, A., 1990. Hepatoprotective Activity of Andrographolide against Galactosamine & Paracetamol Intoxication in Rats. Indian J. Med. Res. 92, 284–292. <https://pubmed.ncbi.nlm.nih.gov/2228075>.
- Handa, S.S., Khanuja, S.P.S., Longo, G., Rakesh, D.D., 2008. Extraction technologies for Medicinal and Aromatic Plants. Earth, Environmental and Marine Sciences and Technologies.
- Hassan, W.N.A.W., Zulkifli, R.M., Ahmad, F., Yunus, M.A.C., 2015. Antioxidant and tyrosinase inhibition activities of *Eurycoma longifolia* and *Swietenia macrophylla*. Journal of Applied Pharmaceutical. Science 5 (08), 006–010. <https://doi.org/10.7324/JAPS.2015.50802>.
- Hendra, R., Ahmad, S., Oskoueian, E., Sukari, A., Shukor, M.Y., 2011. Antioxidant, Anti-Inflammatory and Cytotoxicity of *Phaleria macrocarpa* (Boerl.) Scheff Fruit. BMC Complement. Alternat. Med. 11 (1), 110. <https://doi.org/10.1186/1472-6882-11-110>.
- Hijazi, A., Bandar, H., Rammal, H., Hachem, A., Saad, Z., Badran, B., 2013. Techniques for the extraction of bioactives compounds from Lebanese *Urtica dioica*. Am. J. Pytochem. Clin. Therapeut. 1 (6), 507–513.
- Ho, C.H., Noryati, I., Sulaiman, S.F., Rosma, A., 2010. *In vitro* Antibacterial and Antioxidant Activities of *Orthosiphon stamineus* Benth Extracts Against Food-Borne Bacteria. Food Chem. 122 (4), 1168–1172. <https://doi.org/10.1016/j.foodchem.2010.03.110>.
- Hollman, P.H., Katan, M.B., 1999. Dietary Flavonoids: Intake, Health Effects and Bioavailability. Food Chem. Toxicol. 37 (9–10), 937–942. [https://doi.org/10.1016/S0278-6915\(99\)00079-4](https://doi.org/10.1016/S0278-6915(99)00079-4).
- Hossain, M.A., Ismail, Z., 2009. High Performance Thin Layer Chromatographic Determination of Caffeic Acid and Rosmarinic Acid from the Leaves of *Orthosiphon stamineus*. Indonesian J. Chem. 9 (1), 137–141 <https://doi.org/10.22146/jhc.21575>.

- Hsieh, M.J., Chen, J.C., Yang, W.E., Chien, S.Y., Chen, M.K., Lo, Y.S., Hsi, Y.T., Chuang, Y. C., Lin, C.C., Yang, S.F., 2017. Dehydroandrographolide Inhibits Oral Cancer Cell Migration and Invasion through NF- κ B-, AP-1-, and SP-1-Modulated Matrix Metalloproteinase-2 Inhibition. *Biochem. Pharmacol.* 130, 10–20. <https://doi.org/10.1016/j.bcp.2017.01.011>.
- Hsieh, M.J., Lin, C.W., Chiou, H.L., Yang, S.F., Chen, M.K., 2015. Dehydroandrographolide, an iNOS Inhibitor, Extracted from *Andrographis paniculata* (Burm. f.) Nees, Induces Autophagy in Human Oral Cancer Cells. *Oncotarget* 6 (31), 30831.
- Islam, A.S., Ismail, Z., Saad, B., Othman, A.R., Ahmad, M.N., Shakaff, A.M., 2006. Correlation studies between electronic nose response and headspace volatiles of *Eurycoma longifolia* extracts. *Sens. Actuators, B* 120 (1), 245–251. <https://doi.org/10.1016/j.snb.2006.02.020>.
- Ismail, N.H., Jaafar, F.M., Ahmat, N., Ahmad, R., Hana, N., 2008. Phytochemical and Biological Activity Screening of Plants Collected from Kuala Keniam, Taman Negara, Pahang. In: *Proceeding of National Biodiversity Seminar, 2008*, pp. 77–85. Kuala Lumpur, Malaysia.
- Ismail, S.B., Wan Mohammad, W.M.Z., George, A., Nik Hussain, N.H., Musthapa Kamal, Z.M., Liske, E., 2012. Randomized Clinical Trial on the Use of PHYSTA Freeze-Dried Water Extract of *Eurycoma longifolia* for the Improvement of Quality of Life and Sexual Well-Being in Men. *Evid.-Based Complement. Alternat. Med.* 2012. <https://doi.org/10.1155/2012/429268>.
- Itokawa, H., Kishi, E., Morita, H., Takeya, K., 1992. Cytotoxic quassinoids and tirucallane-type triterpenes from the woods of *Eurycoma longifolia*. *Chem. Pharm. Bull.* 40 (4), 1053–1055. <https://doi.org/10.1248/cpb.40.1053>.
- Jadhao, D., Thorat, B., 2014. Purification (crystallization) of bioactive ingredient andrographolide from *Andrographis paniculata*. *World J. Pharm. Pharmaceut. Sci.* 3 (10), 747–763.
- Jiwajinda, S., Santisopasri, V., Murakami, A., Kawanaka, M., Kawanaka, H., Gasquet, M., Eilas, R., Balansard, G., Ohgishi, H., 2002. *In vitro* anti-tumor promoting and anti-parasitic activities of the quassinoids from *Eurycoma longifolia*, a medicinal plant in Southeast Asia. *J. Ethnopharmacol.* 82 (1), 55–58. [https://doi.org/10.1016/S0378-8741\(02\)00160-5](https://doi.org/10.1016/S0378-8741(02)00160-5).
- Joshi, D.R., Adhikari, N., 2019. An Overview on Common Organic Solvents and their Toxicity. *J. Pharmaceut. Res. Int.* 1–18. <https://doi.org/10.9734/jpri/2019/v28i330203>.
- Jusoh, S., Ghani, R.A., Ab Kadir, W.R.W., Ishak, M.F., 2015. Phytochemical Assessment of Multi-Localities Tongkat Ali (*Eurycoma longifolia*) in Peninsular Malaysia. *Jurnal Teknologi* 77 (3), 87–91.
- Kaewpiboon, C., Lirdprapamongkol, K., Srisomsap, C., Winayanuwattikun, P., Yongvanich, T., Puwapisrisiran, P., Svasti, J., Assavalapsakul, W., 2012. Studies of the *in vitro* cytotoxic, antioxidant, lipase inhibitory and antimicrobial activities of selected Thai medicinal plants. *BMC Complement. Alternat. Med.* 12 (1), 217. <https://doi.org/10.1186/1472-6882-12-217>.
- Kamarudin, N.A., Markom, M., Latip, J., 2016. Effects of Solvents and Extraction Methods on Herbal Plants *Phyllanthus niruri*, *Orthosiphon stamineus* and *Labisia pumila*. *Indian J. Sci. Technol.* 9 (21), 1–5. <https://doi.org/10.17485/ijst/2016/v9i21/95235>.
- Kaufmann, B., Christen, P., 2002. Recent Extraction Techniques for Natural Products: Microwave-Assisted Extraction and Pressurized Solvent Extraction. *Phytochem. Anal.* 13 (2), 105–113. <https://doi.org/10.1002/pca.631>.
- Khanam, Z., Wen, C.S., Bhat, I.U.H., 2015. Phytochemical screening and antimicrobial activity of root and stem extracts of wild *Eurycoma longifolia* Jack (Tongkat Ali). *J. King Saud Univ.-Sci.* 27 (1), 23–30. <https://doi.org/10.1016/j.jksus.2014.04.006>.
- Koay, Y.C., Amir, F., 2012. A Survey of the Chemical Constituents and Biological Activities of *Orthosiphon stamineus*. *Sci. Int.* 24 (2).
- Kumar, P., Rani, S., Arunjothi, B., Chakrapani, P., Rojarani, A., 2017. Evaluation of Antidiabetic Activity of *Gymnema sylvestre* and *Andrographis paniculata* in Streptozotocin Induced Diabetic Rats. *Int. J. Pharmacogn. Phytochem. Res.* 9, 22–25. <https://doi.org/10.25258/ijppar.v9i1.8035>.
- Kumar, R.A., Sridevi, K., Kumar, N.V., Nanduri, S., Rajagopal, S., 2004. Anticancer and Immunostimulatory Compounds from *Andrographis paniculata*. *J. Ethnopharmacol.* 92 (2–3), 291–295. <https://doi.org/10.1016/j.jep.2004.03.004>.
- Kumoro, A.C., Hasan, M., 2008. Extraction of herbal components—the case for supercritical fluid extraction. *Teknik* 29 (3), 180–183 <http://eprints.undip.ac.id/37793>.
- Kumoro, A.C., Hasan, M., Singh, H., 2009. Effects of solvent properties on the Soxhlet extraction of diterpenoid lactones from *Andrographis paniculata* leaves. *Science Asia* 35 (1), 306–309. <https://doi.org/10.2306/scienceasia1513-1874.2009.35.306>.
- Kuppusamy, C., Murugan, K., 2010. Effects of *Andrographis paniculata* Nees on Growth, Development and Reproduction of Malarial Vector *Anopheles stephensi* Liston (Diptera: Culicidae). *Trop. Biomed.* 27 (3), 509–516 <https://pubmed.ncbi.nlm.nih.gov/21399593>.
- Kusuma, H.S., Mahfud, M., 2016. RETRACTED: Preliminary study: Kinetics of Oil Extraction from Basil (*Ocimum basilicum*) by Microwave-Assisted Hydrodistillation and Solvent-Free Microwave Extraction. <https://doi.org/10.1016/j.sajce.2016.06.001>.
- Laboukhi-Khors, S., Daoud, K., Chemat, S., 2017. Efficient Solvent Selection Approach for High Solubility of Active Phytochemicals: Application for the Extraction of an Antimalarial Compound from Medicinal Plants. *ACS Sustain. Chem. Eng.* 5 (5), 4332–4339. <https://doi.org/10.1021/acscuschemeng.7b00384>.
- Lahrita, L., Hirose, R., Kato, E., Kawabata, J., 2017. Isolation and Lipolytic Activity of Eurycomanone and its Epoxy Derivative from *Eurycoma longifolia*. *Bioorg. Med. Chem.* 25 (17), 4829–4834. <https://doi.org/10.1016/j.bmc.2017.07.032>.
- Latiff, N.A., 2015. Fractionation and Characterization of Polyphenols Rich Extract from *Labisia pumila* Leaves (Doctoral dissertation. Universiti Teknologi Malaysia).
- Lau, C.H., Chua, L.S., Lee, C.T., Aziz, R., 2014. Optimization and Kinetic Modeling of Rosmarinic Acid Extraction from *Orthosiphon stamineus*. *Curr. Bioact. Compd.* 10 (4), 271–285. <https://doi.org/10.2174/157340721004150206151452>.
- Lee, M.H., Lin, C.C., 2007. Comparison of Techniques for Extraction of Isoflavones from the Root of *Radix Puerariae*: Ultrasonic and Pressurized Solvent Extractions. *Food Chem.* 105, 223–228. <https://doi.org/10.1016/j.foodchem.2006.11.009>.
- Li, A.N., Li, S., Zhang, Y.J., Xu, X.R., Chen, Y.M., Li, H.B., 2014. Resources and Biological Activities of Natural Polyphenols. *Nutrients*, 6, 12, 6020–6047. <https://dx.doi.org/10.3390%2Fn6126020>.
- Li, Z., Ruan, J.Y., Sun, F., Yan, J.J., Wang, J.L., Zhang, Z.X., Zhang, Y., Wang, T., 2019. Relationship between Structural Characteristics and Plant Sources Along with Pharmacology Research of Quassinoids. *Chem. Pharm. Bull.* 67 (7), 654–665. <https://doi.org/10.1248/cpb.c18-00958>.
- Lim, P.J., Gan, C.S., Yusof, A., 2019. Lipid Lowering Effect of *Eurycoma longifolia* Jack Aqueous Root Extract in Hepatocytes Available on: Kuwait J. Sci. 46 (2) <https://journalskuwait.org/kjs/index.php/KJS/article/view/2702/321>.
- Liu, J., Wang, Z.T., Ji, L.L., 2007. *In vivo* and *In vitro* Anti-Inflammatory Activities of Neoandrographolide. *Am. J. Chin. Med.* 35 (02), 317–328. <https://doi.org/10.1142/S0192415X07004849>.
- Liza, M., Rahman, A.R., Mandana, B., Jinap, S., Rahmat, A., Zaidul, I.S.M., Hamid, A., 2010. Supercritical Carbon Dioxide Extraction of Bioactive Flavonoid from *Strobilanthes crispus* (Pecah Kaca). *Food Bioprod Process* 88, 319–326. <https://doi.org/10.1016/j.fbp.2009.02.001>.
- Low, B.S., Das, P.K., Chan, K.L., 2013. Standardized quassinoid-rich *Eurycoma longifolia* extract improved spermatogenesis and fertility in male rats via the hypothalamic–pituitary–gonadal axis. *J. Ethnopharmacol.* 145 (3), 706–714. <https://doi.org/10.1016/j.jep.2012.11.013>.
- Mahfud, N., Pihie, A.H.L., 2008. Eurycomanone Induces Apoptosis through the Upregulation of P53 in Human Cervical Carcinoma Cells Available on: J. Cancer Mol. 4 (4), 109–115 <http://citeseerx.ist.psu.edu/viewdoc/download?doi=10.1.1.557.8575&rep=rep1&type=pdf>.
- Majidi Wizneh, F., & Zaini Asmawi, M., 2014. *Eurycoma longifolia* Jack (Simarubaceae); Advances in Its Medicinal Potentials. *Pharmacognosy J.* 6, 4. <https://dx.doi.org/10.5530/pj.2014.4.1>.
- Mansor, C.N.A.N.C., Latip, J., Markom, M., 2016, November. Preparation of Orthosiphon Stamineus Enriched Extracts and Evaluation of Their Free Radical Scavenging Activity. In *AIP Conference Proceedings* (Vol. 1784, No. 1, p. 030013). AIP Publishing LLC. <https://doi.org/10.1063/1.4966751>.
- Masayu, I.H., Pin, K.Y., Mohd.Nordin, I., Rabbiah, Z., Mohd.Radzi, A., 2017. Effects of Drying Temperature on Drying Kinetics and Eurycomanone Content of *Eurycoma longifolia* Roots. *J. Food Sci.*, 1, 270–275. <https://doi.org/10.26656/FR.2017.6.112>.
- Meng, D., Li, X., Han, L., Zhang, L., An, W., Li, X., 2014. Four New Quassinoids from the Roots of *Eurycoma longifolia* Jack. *Fitoterapia* 92, 105–110. <https://doi.org/10.1016/j.fitote.2013.10.009>.
- Misra, H., Soni, M., Mehta, D., Mehta, B.K., Jain, D.C., 2009. An improved HPTLC-UV method for rapid estimation of andrographolide in *Andrographis paniculata* (Burm. f.) Nees. *InPharm. Communiqué* 2 (2), 51–54.
- Mohamed, A.N., Vejjayan, J., Yusoff, M.M., 2015. Review on *Eurycoma longifolia* pharmacological and phytochemical properties. *J. Appl. Sci.* 15 (6), 831–844. <https://doi.org/10.3923/jas.2015.831.844>.
- Mohamed, M., Mahmood, W.R.W.D., Markom, M., 2018. Cosolvent Selection for Supercritical Fluid Extraction (SFE) of Bioactive Compounds from *Orthosiphon stamineus*. *Sains Malaysiana* 47 (8), 1741–1747. <https://doi.org/10.17576/jsm-2018-4708-13>.
- Mohd Effendy, N., Mohamed, N., Muhammad, N., Naina Mohamad, I., Shuid, A.N., 2012. *Eurycoma longifolia*: Medicinal Plant in the Prevention and Treatment of Male Osteoporosis due to Androgen Deficiency. *Evid.-based Complement. Alternat. Med.* 2012. <https://doi.org/10.1155/2012/125761>.
- Mulyati, G.D., Nurani, L.H., Widayanti, S., 2017. Effects of co-chemotherapy ethyl acetate fraction of *Eurycoma longifolia* jack roots and doxorubicin against apoptosis through expression p53 mutant and Bcl-2. *Jurnal Kedokteran dan Kesehatan Indonesia* 8 (1), 68–77 <https://doi.org/10.20885/JKKI.Vol8.Iss1.art9>.
- Murugan, N.A., Pandian, C.J., Jeyakanthan, J., 2020. Computational Investigation on *Andrographis paniculata* Phytochemicals to Evaluate their Potency against SARS-CoV-2 in Comparison to Known Antiviral Compounds in Drug Trials. *J. Biomol. Struct. Dyn.* 1–12. <https://doi.org/10.1080/07391102.2020.1777901>.
- Najmuldeen, G.F., Fatmanathan, H., Faisal, G.G., Hassan, Z.B., 2017. Characterization of *Eurycoma longifolia* (Tongkat Ali) Essential Oils Extracted by Microwave Assisted Extraction. *J. Appl. Pharmaceut. Sci.* 7 (6), 62–68. <https://doi.org/10.7324/JAPS.2017.70609>.
- Ngoc, P.B., Pham, T.B., Nguyen, H.D., Tran, T.T., Chu, H.H., Chau, V.M., Lee, J.H., Nguyen, T.D., 2016. A new anti-inflammatory β -carboline alkaloid from the hairy-root cultures of *Eurycoma longifolia*. *Nat. Prod. Res.* 30 (12), 1360–1365. <https://doi.org/10.1080/14786419.2015.1056187>.
- Nhiem, N.X., Thu, V.K., Tai, B.H., Anh, H.L.T., Yen, P.H., Van Minh, C., Van Kiem, P., 2015. Quassinoids from *Eurycoma longifolia*. *Vietnam. J. Chem.* 53 (2e), 82–85. <https://doi.org/10.15625/0866-7144.2015-2e-019>.
- Norhidayah, A., Vejjayan, J., Yusoff, M.M., 2015. Detection and Quantification of Eurycomanone Levels in Tongkat Ali Herbal Products. *J. Appl. Sci.* 15 (7), 999. <https://doi.org/10.3923/jas.2015.999.1005>.

- Ohishi, K., Toume, K., Arai, M.A., Koyano, T., Kowithayakorn, T., Mizoguchi, T., Itoh, M., Ishibashi, M., 2015. 9-Hydroxycanthin-6-one, a β -carboline alkaloid from *Eurycoma longifolia*, is the first Wnt signal inhibitor through activation of glycogen synthase kinase 3 β without depending on casein kinase 1 α . *J. Nat. Prod.* 78 (5), 1139–1146. <https://doi.org/10.1021/acs.jnatprod.5b00153>.
- Othman, Z.S., Hassan, N.H., Yusop, M.R., Zubairi, S.I., 2015. Development of a New Binary Solvent System Using Ionic Liquids as Additives to Improve Rotenone Extraction Yield from Malaysia *Derris* sp. *J. Chem.* 2015. <https://doi.org/10.1155/2015/468917>.
- Pang, S.F., Gimibun, J., Yusoff, M.M., Abdullah, L.C., 2015. Microencapsulation of Polyphenols from *Orthosiphon stamineus* Leaves Extracts using Polysaccharide and Protein. In Malaysia University Conference Engineering Technology (MUCET), Vol. 1, pp. 352–258. Melaka, Malaysia. <http://umpir.ump.edu.my/id/eprint/9410>.
- Pang, S.F., Lau, M.Z., Yusoff, M.M., Gimibun, J., 2017. Microwave-Irradiation Induced Fast Simultaneous Extraction of Methoxylated and Hydroxylated Phenolic Compounds from *Orthosiphon stamineus* Leaves. In Materials Science Forum Vol. 890, pp. 155–158. Trans Tech Publications Ltd. <https://doi.org/10.4028/www.scientific.net/MSF.890.155>.
- Park, S., Nhiem, N.X., Van Kiem, P., Van Minh, C., Tai, B.H., Kim, N., Yoo, H.H., Song, J. H., Ko, H.J., Kim, S.H., 2014. Five new quassinoids and cytotoxic constituents from the roots of *Eurycoma longifolia*. *Bioorg. Med. Chem. Lett.* 24 (16), 3835–3840. <https://doi.org/10.1016/j.bmcl.2014.06.058>.
- Petersen, M., Simmonds, M.S., 2003. Rosmarinic acid. *Phytochemistry* 62 (2), 121–125. [https://doi.org/10.1016/S0031-9422\(02\)00513-7](https://doi.org/10.1016/S0031-9422(02)00513-7).
- Pfisterer, P.H., Rollinger, J.M., Schyschka, L., Rudy, A., Vollmar, A.M., Stuppner, H., 2010. Neoandrographolide from *Andrographis paniculata* as a Potential Natural Chemosensitizer. *Planta Med.* 76 (15), 1698–1700. <https://doi.org/10.1055/s-0030-1249876>.
- Phansawan, B., Pongbangpho, S., 2007. Antioxidant capacities of *Pueraria mirifica*, *Stevia rebaudiana* Bertoni, *Curcuma longa* Linn., *Andrographis paniculata* (Burm. f.) Nees, and *Cassia alata* Linn. for the development of dietary supplement. *Agriculture and Natural Resources* 41 (3), 548–554.
- Purwantingsih, H.A., Chan, K.L., 2011. Free Radical Scavenging Activity of the Standardized Ethanolic Extract of *Eurycoma longifolia* (TAF-273). *Int. J. Pharm. Pharm. Sci.* 3, 343–347. <https://innovareacademics.in/journal/ijpps/Vol3Issue4/2662.pdf>.
- Pushpalatha, E., Muthukrishnan, J., 1995. Larvicidal activity of a few plant extracts against *Culex quinquefasciatus* and *Anopheles stephensi*. *Indian J. Malariol.* 32 (1), 14–23. <https://pubmed.ncbi.nlm.nih.gov/8549835>.
- Razak, M.F.B.A., Yong, P.K., Shah, Z.M., Abdullah, L.C., Yee, S.S., Yaw, I.T.C.S., 2012. The Effects of Varying Solvent Polarity on Extraction Yield of *Orthosiphon stamineus* Leaves. *JApSc* 12 (11), 1207–1210. <https://doi.org/10.3923/jas.2012.1207.1210>.
- Rehman, M.U., Khan, F., Niaz, K., 2020. Introduction to Natural Products Analysis. In Recent Advances in Natural Products Analysis, pp. 3–15. Elsevier. <https://doi.org/10.1016/B978-0-12-816455-6.00001-9>.
- Rehman, S.U., Choe, K., Yoo, H.H., 2016. Review on a Traditional Herbal Medicine, *Eurycoma longifolia* Jack (Tongkat Ali): Its Traditional Uses, Chemistry. *Evid.-Based Pharmacol. Toxicol. Molecules* 21 (3), 331. <https://doi.org/10.3390/molecules21030331>.
- Reverchon, E., 1997. Supercritical Fluid Extraction and Fractionation of Essential Oils and Related Products. *J. Supercrit. Fluids.* 10 (1), 1–37. [https://doi.org/10.1016/S0896-8446\(97\)00014-4](https://doi.org/10.1016/S0896-8446(97)00014-4).
- Rilianawati, S.K., 2011. Cytotoxicity of *Eurycoma longifolia* Extract against Normal and Cervix Cancer Cell Line. *Biopharmaca Research Center*.
- Rubi, R.V.C., Quitain, A.T., Agutaya, J.K.C.N., Doma Jr, B.T., Soriano, A.N., Aurensenia, J., Kida, T., 2019. Synergy of in-situ formation of carbonic acid and supercritical CO₂-expanded liquids: Application to extraction of andrographolide from *Andrographis paniculata*. *J. Supercrit. Fluids* 152. <https://doi.org/10.1016/j.supflu.2019.104546>.
- Safie, Siti & Abd Rahman, Rohana & Abu Bakar, Ariff Fahmi & Adam, Nur. 2015. Consumer Preferences in Selecting Herbal Products. In O. Asiah, H.F. Lim, B.J. Chee, M. Nik Musaadah, M. Mastura, K. Getha, M.G.H. Khoo, P. Mazura, S. Vimala (Ed.), Proceedings of Conference, Strengthening Herbal Industry through Economic Transformation, pp. 331–335. Malaysia: Institute of Forestry Research Malaysia. <https://www.researchgate.net/publication/317424796>.
- Sahena F, Zaidul, I.S.M., Jonap, S. Karim, A., Abbas, K. Norulaini, N and omar A., 2012. Application of Supercritical CO₂ in Lipid Extraction – A Review. *J. Food Eng.*, 95, 240–253. <https://doi.org/10.1016/j.jfoodeng.2009.06.026>.
- Saidan, N.H., Hamil, M.S.R., Memon, A.H., Abdelbari, M.M., Hamdan, M.R., Mohd, K. S., Majid, A.M.S.A., Ismail, Z., 2015. Selected Metabolites Profiling of *Orthosiphon stamineus* Benth Leaves Extracts Combined with Chemometrics Analysis and Correlation with Biological Activities. *BMC Complement. Alternat. Med.* 15 (1), 350. <https://doi.org/10.1186/s12906-015-0884-0>.
- Sarajlija, H., Čukelj, N., Mršić, G.N.D., Brnčić, D., Čurić, D., 2012. Preparation of Flaxseed for Lignin Determination by Gas Chromatography-Mass Spectrometry Method. *Czech J. Food Sci.* 30 (1), 45–52. <https://doi.org/10.17221/107/2010-CJFS>.
- Saranya, P., Geetha, A., Narmadha Selvamathy, S.M.K., 2010. The antioxidant and H⁺K⁺ ATPase inhibitory effect of *Andrographis paniculata* and andrographolide in vitro and in vivo studies. *Pharmacologyonline* 1, 356–376. <https://www.researchgate.net/publication/268267239>.
- Schut, G.A., Zwaving, J.H., 1993. Pharmacological Investigation of Some Lipophilic Flavonoids from *Orthosiphon aristatus*. *Fitoterapia-Milano*, 64, 99–99.
- See, T.Y., Tee, S.I., Ang, T.N., Chan, C.H., Yusoff, R., Ngho, G.C., 2016. Assessment of Various Pretreatment and Extraction Methods for the Extraction of Bioactive Compounds from *Orthosiphon stamineus* Leaf via Microstructures Analysis. *Int. J. Food Eng.* 12 (7), 711–717. <https://doi.org/10.1515/ijfe-2016-0094>.
- Shahidi, F., Yeo, J., 2018. Bioactivities of Phenolics by Focusing on Suppression of Chronic Diseases: A Review. *Int. J. Mol. Sci.* 19 (6), 1573. <https://doi.org/10.3390/ijms19061573>.
- Shaikh, R.U., Meshram, R.J., Gacche, R.N., 2019. An Investigation on in Vitro Anti-Inflammatory and Antiproliferative Potential of Isolated Labdane Diterpenoids from *Andrographis paniculata* (Burm. F.) Wall. Ex Nees: An Important Medicinal Plant Prescribed in Ayurveda. *Eur. J. Integrat. Med.* 32. <https://doi.org/10.1016/j.eujim.2019.100983>.
- Sheeja, K., Guruvayoorappan, C., Kuttan, G., 2007. Antiangiogenic Activity of *Andrographis paniculata* Extract and Andrographolide. *Int. Immunopharmacol.* 7 (2), 211–221. <https://doi.org/10.1016/j.intimp.2006.10.002>.
- Singh, J., 2008. Maceration, Percolation and Infusion Techniques of Extraction of Medicinal and Aromatic Plants (MAPs). India: Central Institute of Medicinal and Aromatic Plants (CIMAP) Lucknow. Available on: http://www.philadelphia.edu.jo/academics/s_telfah/upl oads/method%20of%20extraction.pdf.
- Siva, N., 2008. Antifungal Effect of Leaf Extract of Some Medicinal Plants Against Fusarium Oxysporum Causing Wilt Disease of Solanum melongena L. *Ethnobotanical leaflets* 2008 (1), 19. <https://openiuc.lib.siu.edu/ebf/vol2008/iss1/19>.
- Sriwilaijaroen, N., Kondo, S., Nanthasri, P., Auparakkitanon, S., Suzuki, Y., Wilairat, P., 2010. Antiplasmodial effects of *Brucea javanica* (L.) Merr. and *Eurycoma longifolia* Jack extracts and their combination with chloroquine and quinine on *Plasmodium falciparum* in culture. *Trop. Med. Health* 38 (2), 61–68. <https://doi.org/10.2149/tmh.2009-11>.
- Subramaniam, S., Khan, H.B.H., Elumalai, N., Lakshmi, S.Y.S., 2015. Hepatoprotective Effect of Ethanolic Extract of Whole Plant of *Andrographis paniculata* against CCL₄-Induced Hepatotoxicity in Rats. *Comp. Clin. Pathol.* 24 (5), 1245–1251. <https://doi.org/10.1007/s00580-015-2067-2>.
- Suzuki, R., Matsushima, Y., Okudaira, N., Sakagami, H., Shirataki, Y., 2016. Cytotoxic Components against Human Oral Squamous Cell Carcinoma Isolated from *Andrographis paniculata* Available on: *Anticancer Res.* 36 (11), 5931–5935. <http://ar.iiarjournals.org/content/36/11/5931>.
- Talbott, S.M., Talbott, J.A., George, A., Pugh, M., 2013. Effect of Tongkat Ali on Stress Hormones and Psychological Mood State in Moderately Stressed Subjects. *J. Int. Soc. Sports Nutr.* 10 (1), 1–7. <https://doi.org/10.1186/1550-2783-10-28>.
- Tanwer, B.S., Vijayvergia, R., 2010. Phytochemical evaluation and molluscicidal activity of *Andrographis paniculata*. *Herba Polonica* 56 (4). <https://www.researchgate.net/publication/271522993>.
- Teh, C.H., Murugaiyah, V., Chan, K.L., 2011. Developing a Validated Liquid Chromatography-Mass Spectrometric Method for the Simultaneous Analysis of Five Bioactive Quassinoid Markers for the Standardization of Manufactured Batches of *Eurycoma longifolia* Jack Extract as Antimalarial Medicaments. *J. Chromatogr. A* 1218 (14), 1861–1877. <https://doi.org/10.1016/j.chroma.2011.02.014>.
- Tezuka, Y., Stampoulis, P., Banskota, A.H., Awale, S., Tran, K.Q., Saiki, I., Kadota, S., 2000. Constituents of the Vietnamese Medicinal Plant *Orthosiphon stamineus*. *Chem. Pharm. Bull.* 48 (11), 1711–1719. <https://doi.org/10.1248/cpb.48.1711>.
- Thoo, Y.Y., Ho, S.K., Liang, J.Y., Ho, C.W., Tan, C.P., 2010. Effects of Binary Solvent Extraction System, Extraction Time and Extraction Temperature on Phenolic Antioxidants and Antioxidant Capacity from Mengkudu (*Morinda citrifolia*). *Food Chem.* 120 (1), 290–295. <https://doi.org/10.1016/j.foodchem.2009.09.064>.
- Tong, K.L., Chan, K.L., AbuBakar, S., Low, B.S., Ma, H.Q., Wong, P.F., 2015. The in vitro and in vivo anti-cancer activities of a standardized quassinoids composition from *Eurycoma longifolia* on Incap human prostate cancer cells. *PLoS ONE* 10, (3). <https://doi.org/10.1371/journal.pone.0121752> e0121752.
- Tran, T.V.A., Malainer, C., Schwaiger, S., Atanasov, A.G., Heiss, E.H., Dirsch, V.M., Stuppner, H., 2014. NF- κ B inhibitors from *Eurycoma longifolia*. *J. Nat. Prod.* 77 (3), 483–488. <https://doi.org/10.1021/np400701k>.
- Trivedi, P., Singh, R., Shanker, K., 2011. Micellar extraction and cloud-point preconcentration of labdane diterpenoids from *Andrographis paniculata*. *J. Liq. Chromatogr. Relat. Technol.* 34 (18), 2085–2102. <https://doi.org/10.1080/10826076.2011.585480>.
- Tung, N.H., Uto, T., Hai, N.T., Li, G., Shoyama, Y., 2017. Quassinoids from the root of *Eurycoma longifolia* and their antiproliferative activity on human cancer cell lines. *Pharmacognosy Magazine*, 13, 51, 459. https://doi.org/10.4103/pm.pm_353_16.
- Vasu, S., Palaniyappan, V., Badami, S., 2010. A novel microwave-assisted extraction for the isolation of andrographolide from *Andrographis paniculata* and its in vitro antioxidant activity. *Nat. Prod. Res.* 24 (16), 1560–1567. <https://doi.org/10.1080/14786419.2010.495071>.
- Wang, D.G., Liu, W.Y., Chen, G.T., 2013. A Simple Method for the Isolation and Purification of Resveratrol from *Polygonum cuspidatum*. *J. Pharm. Anal.* 3, 241–247. <https://doi.org/10.1016/j.jpba.2012.12.001>.
- Wang, J., Sun, B., Cao, Y., Tian, Y., Li, X., 2008. Optimisation of Ultrasound-Assisted Extraction of Phenolic Compounds from Wheat Bran. *Food Chem.* 106 (2), 804–810. <https://doi.org/10.1016/j.foodchem.2007.06.062>.
- Waszkowiak, K., Gliszczynska-Swiglo, A., Barthel, V., Skrety, J., 2015. Effect of Extraction Method on the Phenolic and Cyanogenic Glucoside Profile of Flaxseed Extracts and their Antioxidant Capacity. *J. Am. Oil Chem. Soc.* 92, 1609–1619. <https://doi.org/10.1007/s11746-015-2729-x>.
- Wong, Y.H., Lau, H.W., Tan, C.P., Long, K., Nyam, K.L., 2014. Binary Solvent Extraction System and Extraction Time Effects on Phenolic Antioxidants from Kenaf Seeds

- (*Hibiscus cannabinus* L.) Extracted by a Pulsed Ultrasonic-Assisted Extraction. *Sci. World J.*, 2014. <https://doi.org/10.1155/2014/789346>.
- Xu, X.Q., Hu, G.L., Shen, J.C., Li, Q., Wang, X.R., 2002. Determination of Andrographolide and Dehydroandrographolide in *Andrographis paniculata* Nees Materials and Related Patent Medicines by Reversed-Phase High Performance Liquid Chromatography. *Se pu= Chinese J. Chromatogr.* 20 (5), 446–448.
- Yaqub, S., Farooq, U., Shafi, A., Akram, K., Murtaza, M.A., Kausar, T., Siddique, F., 2016. Chemistry and Functionality of Bioactive Compounds Present in Persimmon. *J. Chem.* 2016. <https://doi.org/10.1155/2016/3424025>.
- Yeop, A., Sandanasam, J., Pan, S.F., Abdulla, S., Yusoff, M.M., Gimbun, J., 2017. The Effect of Particle Size and Solvent Type on The Gallic Acid Yield Obtained from *Labisia Pumila* by Ultrasonic Extraction. In MATEC Web of Conferences, Vol. 111, p. 02008. EDP Sciences. <https://doi.org/10.1051/mateconf/201711102008>.
- Zakaria, M.H., Abdullah, A.M., Kamarulzaman, N.H., Abdul Latif, I., 2019. Transformation of Herbal Industry in Malaysia. Macro Outlook of Herbal Industry in Malaysia, Agribusiness. Food and Fertilizer Technology for the Asian and Pacific Region (FFTC-AP), Malaysia.
- Zakaria, N., Mohd, K.S., Hamil, M.S.R., Memon, A.H., Asmawi, M.Z., Ismail, Z., 2017. Characterization of primary and secondary metabolites of leaf and stem extracts from *Eurycoma longifolia* jack. *J. Fundam. Appl. Sci.* 9 (2S), 661–679. <https://doi.org/10.4314/jfas.v9i2s.41>.
- Zhang, H.F., Yang, X.H., Zhao, L.D., Wang, Y., 2009. Ultrasonic Assisted Extraction of Epimedin C from Fresh Leaves of *Epimedium* and Extraction Mechanism. *Innovative Food Sci. Emerg. Technol.* 10, 54–60. <https://doi.org/10.1016/j.ifset.2008.09.007>.
- Zhang, Z.S., Li, D., Wang, L.J., Ozkan, N., Chen, X.D., Mao, Z.H., Yang, H.Z., 2007. Optimization of Ethanol-Water Extraction of Lignans from Flaxseed. *Sep. Purif. Technol.* 57 (1), 17–24. <https://doi.org/10.1016/j.seppur.2007.03.006>.