

Article

Open Access

Genome-wide analysis reveals signatures of complex introgressive gene flow in macaques (genus *Macaca*)

Yang Song¹, Cong Jiang¹, Kun-Hua Li¹, Jing Li², Hong Qiu¹, Megan Price¹, Zhen-Xin Fan^{1,3}, Jing Li^{1,3,*}

¹ Key Laboratory of Bio-resources and Eco-environment of Ministry of Education, College of Life Sciences, Sichuan University, Chengdu, Sichuan 610064, China

² Institute of Animal Genetics and Breeding, College of Animal Science and Technology, Sichuan Agricultural University, Chengdu, Sichuan 611130, China

³ Sichuan Key Laboratory of Conservation Biology on Endangered Wildlife, College of Life Sciences, Sichuan University, Chengdu, Sichuan 610064, China

ABSTRACT

The genus *Macaca* serves as an ideal research model for speciation and introgressive gene flow due to its short period of diversification (about five million years ago) and rapid radiation of constituent species. To understand evolutionary gene flow in macaques, we sequenced four whole genomes (two *M. arctoides* and two *M. thibetana*) and combined them with publicly available macaque genome data for genome-wide analyses. We analyzed 14 individuals from nine *Macaca* species covering all Asian macaque species groups and detected extensive gene flow signals, with the strongest signals between the *fascicularis* and *silenus* species groups. Notably, we detected bidirectional gene flow between *M. fascicularis* and *M. nemestrina*. The estimated proportion of the genome inherited via gene flow between the two species was 6.19%. However, the introgression signals found among studied island species, such as Sulawesi macaques and *M. fuscata*, and other species were largely attributed to the genomic similarity of closely related species or ancestral introgression. Furthermore, gene flow

signals varied in individuals of the same species (*M. arctoides*, *M. fascicularis*, *M. mulatta*, *M. nemestrina* and *M. thibetana*), suggesting very recent gene flow after the populations split. Pairwise sequentially Markovian coalescence (PSMC) analysis showed all macaques experienced a bottleneck five million years ago, after which different species exhibited different fluctuations in demographic history trajectories, implying they have experienced complicated environmental variation and climate change. These results should help improve our understanding of the complicated evolutionary history of macaques, particularly introgressive gene flow.

Keywords: *Macaca*; Whole genome; Introgression; Gene flow; Demographic history

INTRODUCTION

Natural hybridization between closely related species plays an important role in evolution and is now recognized as common in animals, including primates (Arnold & Meyer, 2006; Baiz et al., 2020; Cortés-Ortiz et al., 2007; Fan et al., 2018; Gante et al., 2016; Kuhlwillm et al., 2019; Martin & Jiggins, 2017;

This is an open-access article distributed under the terms of the Creative Commons Attribution Non-Commercial License (<http://creativecommons.org/licenses/by-nc/4.0/>), which permits unrestricted non-commercial use, distribution, and reproduction in any medium, provided the original work is properly cited.

Copyright ©2021 Editorial Office of Zoological Research, Kunming Institute of Zoology, Chinese Academy of Sciences

Received: 19 April 2021; Accepted: 20 May 2021; Online: 09 June 2021

Foundation items: This work was supported by the National Natural Science Foundation of China (31530068, 31770415) and Fundamental Research Funds for the Central Universities (SCU2021D006)

*Corresponding author, E-mail: ljtjf@126.com

Rogers et al., 2019; Zhang et al., 2017). Hybridization is an important source of genetic variation during the evolutionary process and can introduce adaptive variants to recipient populations and even drive new species formation (Figueiro et al., 2017; Martin & Jiggins, 2017; Zinner et al., 2011). The footprints left by hybridization in genomes allow the detection of ancient hybridization and gene flow, with sequencing technology enabling research on whole-genome data. The ever-growing database of whole genomes from multiple species and populations can now be used to address important evolutionary questions, such as introgressive hybridization, incomplete lineage sorting (ILS), and speciation-with-gene-flow (Árnason et al., 2018).

At present, the genus *Macaca* is comprised of 23 extant species. Macaques are the most widely distributed non-human primates and occupy a wide range of habitats (Ito et al., 2018; Roos et al., 2019). Except for *M. sylvanus*, which is distributed in Africa (Algeria and Morocco), all other species are found in Asia (see IUCN Red List). Historically, macaques dispersed into Eurasia during the late Miocene, roughly coinciding with the sea level drop associated with the Messinian Salinity Crisis (Abbott et al., 2013; Roos et al., 2019). The oldest putative *Macaca* fossils in Europe and Asia date to 5.9–5.3 million years ago (Ma) and 4.9–3.6 Ma, respectively (Roos et al., 2019). After reaching Asia, *Macaca* experienced rapid speciation and radiation due to climate and environmental change during the late Pliocene and Pleistocene (Abbott et al., 2013; Roos et al., 2019; Woodruff, 2010). *Macaca* can be classified into four or seven species groups (Delson, 1980; Fooden, 1976; Groves, 2001; Roos et al., 2014, 2019). The seven species group classification includes three new species groups, i.e., *arctoides*, *mulatta*, and *sulawesi* (Roos et al., 2014), by separating *M. arctoides*, *M. mulatta*+*M. fuscata* and all Sulawesi macaque species (respectively) from three (*sinica*, *fascicularis*, and *silenus*) of the four species groups (Delson, 1980). In this study, we used the four species group classification (*sylvanus*, *silenus*, *fascicularis*, and *sinica*) proposed by Delson (1980). Our samples covered all Asian groups of macaques, including *silenus* (*M. nemestrina*, *M. nigra*, and *M. tonkeana*), *fascicularis* (*M. fascicularis*, *M. fuscata*, and *M. mulatta*), and *sinica* (*M. arctoides*, *M. assamensis*, and *M. thibetana*).

Hybridization has been previously reported in *Macaca*, e.g., between *M. fuscata* and *M. cyclopis* (Hamada et al., 2012), *M. mulatta* and *M. fascicularis* (Hamada et al., 2016; Ito et al., 2020; Rovie-Ryan et al., 2021), *M. thibetana* and Chinese *M. mulatta* (Fan et al., 2014), *M. arctoides* and *fascicularis* species group (Fan et al., 2018; Jiang et al., 2016; Li et al., 2009; Tosi et al., 2000, 2003b), and between Sulawesi macaques (Ciani et al., 1989). Active tectonics and changing climate and sea levels during the Pliocene and Pleistocene and the periodic formation of land bridges in Southeast Asia significantly influenced *Macaca* evolution and allowed possible hybridization or introgression among species/species groups (Meijaard, 2003). In addition, macaques have an almost identical chromosome karyotype, a factor that may facilitate hybridization among species and the production of viable hybrid offspring (Hamada et al., 2012; Yang & Shi, 1994). In recent years, there has been a considerable increase in

whole-genome-based studies on hybridization in macaques. For example, Fan et al. (2014) reported on hybridization between *M. thibetana* and *M. mulatta* based on whole-genome sequencing analysis of *M. thibetana*. Fan et al. (2018) identified an introgression event in the evolutionary history of *M. arctoides* by genome-wide analysis. Osada et al. (2021) reported on sex-biased admixture between the *fascicularis* and *sinica* species groups based on whole-genome analysis of 17 macaques. Vanderpool et al. (2020) performed phylogenomic analysis of primates, including three species of macaques, and found introgression between *M. nemestrina* and *M. fascicularis*. Ito et al. (2020) suggested potential gene flow between *M. fascicularis* and *M. mulatta* following secondary contact after a period of isolation, and that the migration rate from *M. mulatta* to *M. fascicularis* may be slightly higher than in the opposite direction.

However, most field observations and molecular-based analyses of *Macaca* hybridization have focused on the most recently diverged species groups of *fascicularis* and *sinica*, with gene flow between the more basal *silenus* group and other groups less studied. Moreover, genus-wide hybridization or gene flow studies of *Macaca* are scarce, particularly with whole-genome data. Here, we included three species from the *silenus* group and presented high-coverage whole-genome data of four macaques (two *M. arctoides* and two *M. thibetana*). Combined with other publicly available data, our study included 14 individuals from nine *Macaca* species, covering all species groups of Asian macaques. We estimated local evolutionary histories, reconstructed a multispecies coalescent phylogenetic tree, and explored ancient or ongoing introgressive gene flow in macaques based on whole-genome DNA sequences. Furthermore, we also analyzed the genetic diversity and demographic history of macaques.

MATERIALS AND METHODS

Ethics statement

All samples were collected following the Regulations for the Implementation of the Protection of Terrestrial Wildlife of China (State Council Decree [1992] No. 13). Throughout the procedures, all animals received humane care to avoid suffering and to ensure animal welfare. All animal protocols involved in this study were reviewed and approved by the Ethics Committee of the College of Life Science, Sichuan University, China (Permit No.: 20200327009).

Samples and sequencing

The genomes of two *M. arctoides* and two *M. thibetana* were sequenced using Illumina HiSeq 2500 technology with a 150 bp paired-end strategy. DNA was isolated from blood using a commercially available DNeasy Blood and Tissue Kit (Qiagen, Germany). Sequencing libraries were prepared with an insert size of 300 bp. The two *M. arctoides* individuals were from the Yunnan Province and Guangxi Zhuang Autonomous Region of China, respectively. The two *M. thibetana* monkeys were from the Anhui Province and Guangxi Zhuang Autonomous Region of China, respectively (Table 1). In addition, we downloaded 11 genome sequence data from the NCBI SRA database. In total, we used whole-genome data from 14 individuals

Table 1 Information on samples and genomic data

Scientific name	Common name	Sample ID	NCBI accession No.	Sex	Sample origin	Sequencing platform	No. of bases (Gb)	Depth*
<i>M. arctoides</i>	Stump-tailed macaque	Marc_R02	This study, SAMN15194901	Male	Yunnan, China	ILLUMINA	152.0	~47.0×
		Marc_R19	This study, SAMN15194902	Female	Guangxi, China	ILLUMINA	112.2	~34.7×
<i>M. assamensis</i>	Assamese macaque	Mass	SRR2981114	Male	Yunnan, China	ILLUMINA	154.0	~47.6×
<i>M. fascicularis</i>	Crab-eating macaque	Mfas_1	SRR8194877	Female	Unknown (in captivity in China)	ILLUMINA	92.1	~28.5×
		Mfas_Mau	ERS629711	Male	Mauritius	ILLUMINA	61.6	~19.0×
<i>M. fuscata</i>	Japanese macaque	Mfus	DRR002234	Unknown	Japan	ILLUMINA	142.5	~44.0×
<i>M. mulatta</i>	Rhesus macaque	Mmul_Chi	SRR1944102	Female	China	ILLUMINA	144.5	~44.7×
		Mmul_Ind	SRR1952166	Female	India	ILLUMINA	131.3	~40.6×
<i>M. nemestrina</i>	Southern pig-tailed macaque	Mnem_1	SRR1698391, SRR1698394, SRR1698403, SRR1698405	Female	Unknown	ILLUMINA	152.7	~47.2×
		Mnem_2	SRR5947292	Male	Borneo, Malaysia	ILLUMINA	140.7	~43.5×
<i>M. nigra</i>	Black crested macaque	Mnig	SRR5947294	Female	Sulawesi, Indonesia	ILLUMINA	135.8	~42.0×
<i>M. thibetana</i>	Tibetan macaque	Mthi_HT1	This study, SAMN15194903	Female	Anhui, China	ILLUMINA	93.7	~29.0×
		Mthi_R25	This study, SAMN15194904	Female	Guangxi, China	ILLUMINA	113.9	~35.2×
<i>M. tonkeana</i>	Tonkean macaque	Mton	SRR5947293	Male	Sulawesi, Indonesia	ILLUMINA	135.4	~41.8×
<i>P. anubis</i>	Olive baboon	Panu	SRR8723580	Female	Unknown	ILLUMINA	137.9	~42.6×

For individual macaque genome samples, scientific name, common name, sample ID, NCBI accession No., sex, sample origin, sequencing platform, No. of bases, and sequencing depth are shown. New whole-genome sequences of this study are marked in bold. *: Calculations were based on total length of *M. mulatta* genome assembly Mmul_8.0.1, 3 236 224 332 bp.

belonging to *Macaca* and one individual of *Papio anubis* in our study. The 15 whole-genome sequences covered all species groups of Asian macaques and included 10 species: i.e., *M. arctoides* (stump-tailed macaque), *M. thibetana* (Tibetan macaque), *M. assamensis* (Assamese macaque), *M. nemestrina* (southern pig-tailed macaque), *M. nigra* (black-crested macaque), *M. tonkeana* (Tonkean macaque), *M. fascicularis* (crab-eating macaque), *M. mulatta* (rhesus macaque), *M. fuscata* (Japanese macaque), and *P. anubis* (olive baboon). Detailed information on the 15 genomes and sequencing data is given in Table 1 and the “Detailed information on samples” section in the Supplementary Materials.

Single nucleotide variant (SNV) calling

Quality control of reads was performed using fastp (v.0.20.0) (Chen et al., 2018) and Trim Galore (http://www.bioinformatics.babraham.ac.uk/projects/trim_galore/, v.0.6.1). Firstly, low-quality bases were trimmed at both ends of the reads using fastp with parameters: fastp --detect_adapter_for_pe -5 -3. Adapter sequences were then cut using Trim Galore with parameters: trim_galore -q 20 --phred33 --stringency 3 -e 0.1 -length 50 --max_n 0 --trim-n -j 4 -paired. Filtered reads were mapped to the *M. mulatta* genome Mmul_8.0.1 (NCBI Assembly ID GCA_000772875.3) with Bowtie2 (v.2.3.5.1) (Langmead & Salzberg, 2012). As a new Mmul_10 reference genome is now available, genome-wide analyses based on the new reference may be slightly different from the present

study. From the mapped reads, SNVs were called using the Genome Analysis Toolkit (GATK, v.4.1.2.0) (DePristo et al., 2011) following the GATK germline short variant discovery workflow (https://software.broadinstitute.org/gatk/best-practices/workflow?id=11145). Repetitive sequences of the Mmul_8.0.1 assembly were annotated using RepeatMasker (v.open-4.0.9) (Tarailo-Graovac & Chen, 2009). The SNV sites were filtered out when one or more of the following criteria were met: overlap with repetitive sequences, DP<3.0, QD<2.0, SOR>3.0, FS>60.0, MQ<40.0, MQRankSum<-12.5, and ReadPosRankSum<-8.0. Statistics of SNVs were calculated using bcftools (v.1.9) (Li, 2011) (Table 2).

Phylogenetic reconstruction

The SNVs of all samples were merged using bcftools (v.1.9) with the parameter -0. The SNVs from every non-overlapping 100 kb genome fragment were concatenated separately. Heterozygous SNVs were represented according to the degenerate base naming rules of the International Union of Pure and Applied Chemistry (IUPAC). We called the concatenated sequences “SNV-fragment”. In total, 26 633 SNV-fragments were obtained for phylogenetic analysis. For each SNV-fragment, a phylogenetic tree was computed using IQ-TREE (v.1.6.10) (Hoang et al., 2018; Kalyaanamoorthy et al., 2017; Nguyen et al., 2015) with parameters: -stDNA -bb 1000 -m MFP+ASC. Branches of the SNV-fragment trees with support values lower than 30% were contracted using Newick utilities (v.1.6) (Junier & Zdobnov, 2010). Based on all SNV-

Table 2 SNV information for each analyzed macaque

Sample	Filtered			Downsampled (~15×)					
	SNVs	Homo	Het	Callable sites	Het	Heterozygosity	Ts	Tv	Ts/Tv
Marc_R02	7 271 275	5 383 371	1 887 904	2 555 381 332	3 782 713	0.001 480	10 682 013	4 949 053	2.16
Marc_R19	7 000 609	5 675 953	1 324 656	2 553 354 858	2 644 171	0.001 036	10 334 343	4 762 614	2.17
Mass	7 926 468	4 560 039	3 366 429	2 519 264 130	6 121 131	0.002 430	10 831 112	5 023 843	2.16
Mfas_1	6 909 052	3 101 413	3 807 639	2 562 592 812	7 612 441	0.002 971	10 058 278	4 638 571	2.17
Mfas_Mau	6 773 377	3 895 560	2 877 817	2 549 849 925	5 881 316	0.002 307	10 190 936	4 659 300	2.19
Mfus	4 805 372	3 403 338	1 402 034	2 562 072 275	2 619 778	0.001 023	7 074 787	3 279 216	2.16
Mmul_Chi	5 192 005	2 071 981	3 120 024	2 556 851 619	5 748 608	0.002 248	7 168 259	3 273 752	2.19
Mmul_Ind	4 058 527	1 370 638	2 687 889	2 550 406 218	5 072 952	0.001 989	5 723 495	2 602 782	2.20
Mnem_1	8 733 029	4 860 252	3 872 777	2 559 986 484	7 267 811	0.002 839	12 211 436	5 571 807	2.19
Mnem_2	8 568 074	4 907 725	3 660 349	2 557 580 297	7 210 573	0.002 819	12 310 845	5 636 798	2.18
Mnig	7 743 384	6 043 224	1 700 160	2 553 652 584	3 353 047	0.001 313	11 259 320	5 250 264	2.14
Mthi_HT1	6 133 336	5 691 120	442 216	2 488 747 849	903 396	0.000 363	9 401 283	4 277 321	2.20
Mthi_R25	6 858 249	5 921 203	937 046	2 552 204 059	1 886 287	0.000 739	10 137 409	4 730 651	2.14
Mton	8 229 873	5 597 616	2 632 257	2 555 184 660	5 168 771	0.002 023	11 872 755	5 501 580	2.16
Panu	17 507 271	15 461 142	2 046 129	2 529 072 236	3 620 049	0.001 431	25 935 871	11 112 178	2.33

For individual macaque genome samples, short ID, total number of single nucleotide variants (SNVs), number of heterozygous SNVs (Het), number of homozygous SNVs (Homo), and transitions/transversions (Ts/Tv) are shown.

fragment trees, ASTRAL (v.5.6.3) (Zhang et al., 2018) and MP-EST (v.2.0) (Liu et al., 2010) were used to estimate the species tree with default parameters. The species tree was rooted with *P. anubis*. These two programs generated the same phylogenetic topology. We tested multiple genome fragment sizes (30, 50, 70, and 100 kb). All genome fragment sizes led to consistent results.

Divergence time estimation

We randomly selected one of the first 1 000 SNVs and selected one every 1 000 SNVs with this SNV as the starting point. We then concatenated these SNVs to form an alignment to estimate divergence time. The final alignment length was 28 498 bp. To reduce the consumption of computing resources and time, the first 20 000 sites of the alignment were used to estimate divergence time with SNAPP (Bryant et al., 2012) in BEAST (v2.6.0) (Bouckaert et al., 2014) under the following parameters: (1) four age constraints, which were derived from our unpublished genome assembly-based divergence time estimations of *Macaca* by MCMCTree (Yang, 2007) (Supplementary Table S1); (2) chain length of 1 000 000 MCMC iterations; and (3) species tree generated from ASTRAL as a guide tree. An ascertainment-bias correction was applied to the divergence time estimations because of no constant site in the SNV data (Bryant et al., 2012; Lewis, 2001). We performed divergence time estimation three times to confirm similar results (see Stange et al. (2018) for detailed methods of divergence time estimation). The topology generated from SNAPP was used for subsequent analyses.

Gene flow analyses

The *D* statistic (Green et al., 2010) utilizes the number of biallelic sites that meet the ABBA or BABA site pattern in a four-taxon phylogeny, and requires a phylogenetic topology following (((P1, P2), P3), O) with P1 to P3 being ingroups and O being the outgroup. We applied the *D* statistic to all asymmetric four-taxon phylogenies that could be extracted

from the species tree with *P. anubis* as an outgroup using Dsuite (v.0.2 r17) (Malinsky et al., 2021). This resulted in 364 gene flow analyses. Four-taxon phylogenies with corrected $P < 0.001$ were retained. The f_d statistic quantifies the proportion of the genome affected by introgression and utilizes four-taxon phylogeny equaling the *D* statistic (Martin et al., 2015). The f_d statistic of the retained four-taxon phylogenies was calculated using Dsuite. Gene flow direction can be estimated by a derivation of the *D* statistic, i.e., D_{FOIL} analysis (Pease & Hahn, 2015). D_{FOIL} analysis requires a symmetric five-taxon phylogeny with a specific topology. Therefore, not all combinations of five taxa could be analyzed. All symmetric five-taxon phylogenies (with *P. anubis* as the outgroup) that fit D_{FOIL} analysis were extracted and D_{FOIL} analyses were finished using ExD_{FOIL} (Lambert et al., 2019).

We found that all species pairs between the *fascicularis* and *silenus* species groups exhibited very strong gene flow signals. Therefore, further analyses were undertaken to determine if these signals reflected hybridization between the examined extant species after all dichotomous divergence events. We calculated the f_d statistic for all species pairs based on non-overlapping 30 kb windows. The script for calculating f_d based on sliding windows was deposited in GitHub (https://github.com/sy-snake/Sliding_window_D_and_fd). We selected pairs from the *M. fascicularis-silenus* group species (*M. nemestrina*, *M. nigra*, and *M. tonkeana*) and *M. nemestrina-fascicularis* group species (*M. fascicularis*, *M. fuscata*, and *M. mulatta*) as target pairs. We then selected the top 5% of windows with the strongest f_d value of target species pairs for subsequent analyses. Of these windows, we discarded any that met the following criteria: (1) appeared in more than 60% of all species pairs; (2) window coverage was larger than two times or less than one third of the sample's average coverage; and (3) window heterozygosity was larger than two times the sample's whole-genome heterozygosity. The overlapping ratios of the remaining windows of target

pairs from the *M. fascicularis-silenus* group species and *M. nemestrina-fascicularis* group species were calculated to determine whether these strong hybridization signals were due to genomic similarity of closely related species or hybridization between checked species after all dichotomous divergence events. If we assume that the genome fragments exchanged during hybridization are random, then these windows should not be shared at a high level among species pairs. If this ratio is high, we can assume that strong hybridization signals are largely due to the genomic similarity of closely related species.

We also checked genes (including upstream 5 kb) located in the top 5% of windows of species pair *M. fascicularis-M. nemestrina* using bedtools with parameters: bedtools intersect -wo -f 0.5 -F 0.5 -e. Kyoto Encyclopedia of Genes and Genomes (KEGG) and Gene Ontology (GO)-based enrichment analyses of these genes were performed using g:Profiler (Reimand et al., 2007). We set *M. mulatta* as the background organism, statistical domain scope to “all known genes”, significance threshold to “g:SCS thread”, and remaining parameters to default.

Inference of reticulate phylogenies

PhyloNetworks (Solís-Lemus et al., 2017) uses maximum pseudolikelihood methods to estimate phylogenetic networks. Here, we used the “snaq!” program in PhyloNetworks and applied different maximum numbers of hybrid nodes (hmax: 0–6) using the 26 633 SNV-fragment trees as input for 100 iterations. Each network generated from PhyloNetworks has a network score, with lower scores indicating better networks. Similarly, PhyloNet (Wen et al., 2018) was specifically developed to reconstruct reticulate phylogenies from a set of gene trees. We used the “InferNetwork_MPL” method with 1 000 runs and six as the maximum number of reticulations, yielding five optimal networks to analyze the 26 633 SNV-fragment trees. We ran the program multiple times with a different maximum number of reticulations (0–6). When the maximum number of reticulations was set to five, the number of reticulations in the phylogenetic networks no longer increased. We set the maximum number of reticulations to six to ensure that the number of reticulations did not increase. Consensus networks of the 26 633 SNV-fragment trees were generated using phangorn (v.2.5.5) (Schliep, 2011) with different proportions.

Demographic history

The demographic histories of the 14 *Macaca* individuals were inferred from genome sequences using the pairwise sequentially Markovian coalescence model (PSMC) (Li & Durbin, 2011). Only autosomes of reference assembly Mmul_8.0.1 were used in the demographic history analyses. Input files for PSMC were generated using bcftools mpileup and vcftools with the minimum and maximum depth of coverage thresholds set to one third and two times the sample’s average depth, respectively. PSMC was run for 25 iterations, with a N_0 -scaled maximum coalescent time of 15, initial θ/ρ ratio of 5, and time intervals of 64 parameterized as “1×6+58×1”. Bootstrapping was performed for 100 runs. PSMC plots were scaled with a mutation rate of $\mu=0.58\times 10^{-8}$

per bp per generation (Wang et al., 2020) and a generation time of $g=10$. According to published reports, the reproductive age of *M. mulatta* ranges from about four years old to late teens, resulting in a median parent birth age of about 10 years (Kubisch et al., 2012; Xue et al., 2016). Therefore, we used 10 as the generation time.

Genome-wide heterozygosity

Genetic diversity was assessed using heterozygosity of each individual. To exclude potential effects of different sequencing coverage of each macaque, the BAM files were downsampled to $\sim 15\times$ using GATK. Heterozygosity was estimated based on the downsampled BAM files. SNVs of autosomes were called using bcftools with the parameter “bcftools mpileup -C50 -Ou | bcftools call -m”. Heterozygosity of individuals was calculated as the number of heterozygous sites divided by the total number of callable sites across the whole genome. In addition, we performed a calculation of heterozygosity from genomic non-overlapping 1 Mb windows.

RESULTS

Genome sequencing and SNV calling

Sequencing of genomic DNA from the two *M. arctoides* and two *M. thibetana* using Illumina technology yielded 93.7–152.0 Gb of data. Combined with the 11 whole-genome sequences downloaded from the NCBI SRA database, a total of 15 whole-genome sequences were used for subsequent analyses. Reference genome mapping of the 15 whole-genome sequences against the *M. mulatta* genome assembly Mmul_8.0.1 yielded genome coverages of 17.8–43.0%. Table 1 and Supplementary Table S2 detail the sequencing and mapping data and provide accession numbers of the included species. RepeatMasker (Tarailo-Graovac & Chen, 2009) identified 51.95% of repetitive sequences in the *M. mulatta* (reference) genome. Of these, 12.75% and 18.94% were short and long interspersed elements (SINE and LINEs), respectively (Supplementary Table S3). The repetitive sequence regions were excluded in SNV calling. After a series of filters, we identified 4.06–8.73 million SNVs in the 14 macaque genomes. Detailed information on the SNVs is shown in Table 2. Concatenating SNVs from every non-overlapping 100 kb genome fragment yielded 26 633 alignments, totaling 28 497 813 bp in length for each sample. These alignments were used for subsequent evolutionary analyses.

Local and genome-wide evolutionary histories of macaques

Model testing suggested different models for different SNV-fragments. The 26 633 SNV-fragment trees were then constructed based on SNV-fragment-specified models. The distributions of SNV-fragment trees across genomes at the individual level and species group level are shown in Figure 1 and Supplementary Figure S1. The local evolutionary histories of the macaques showed many conflicts (Figure 1), indicating different genomic areas had different evolutionary signals across the macaque genome, which implies complex evolutionary histories of macaques. Various programs were

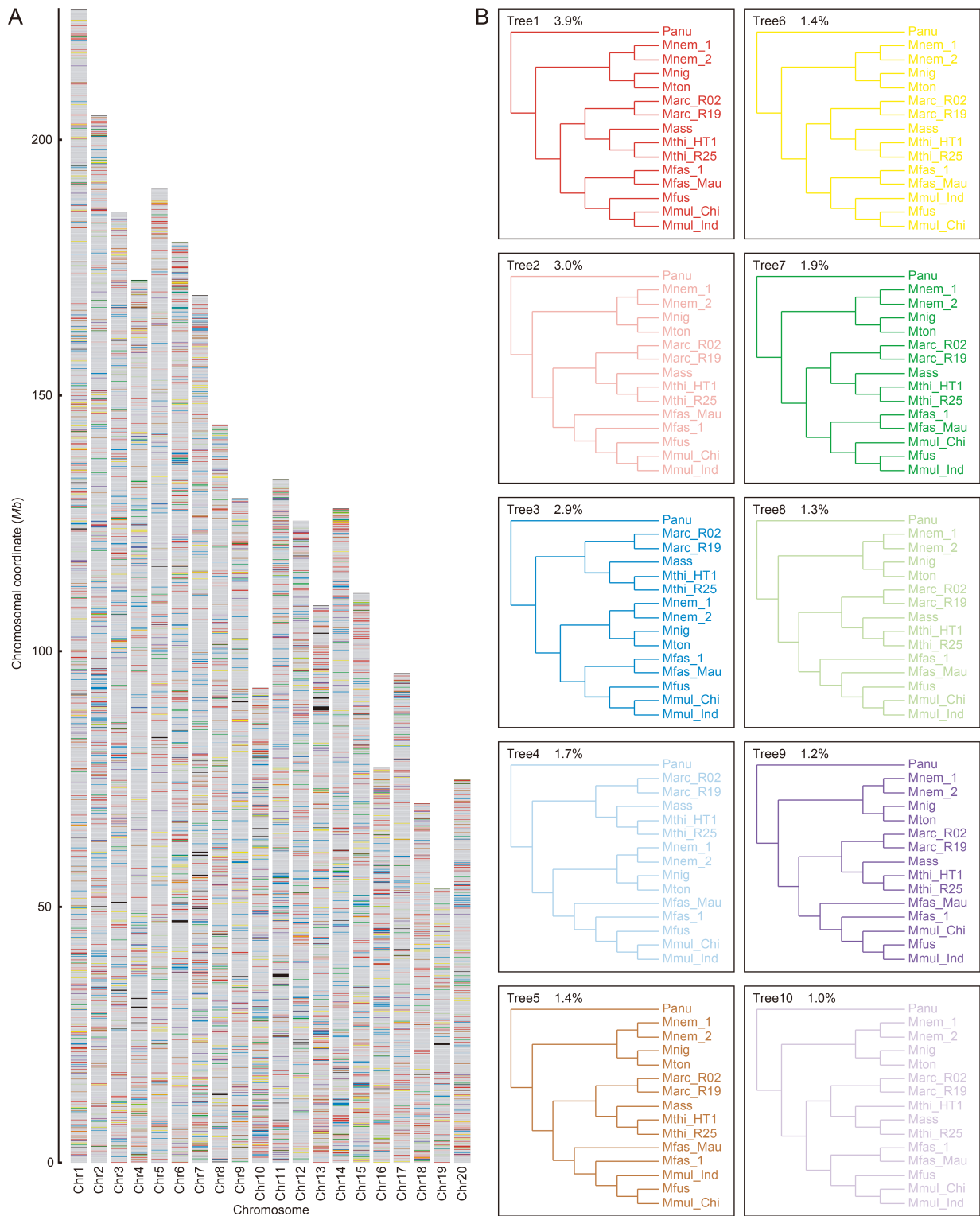

Figure 1 Local evolutionary history of macaques at individual level

A: Each bar represents a chromosome, in terms of *M. mulatta* genome. Colored bands represent tree topologies of each 100 kb window. Colors correspond to topologies in (B). B: Ten most common trees. Values at top left corner are percentage of all 100 kb windows that recover that topology. Colors correspond to colored bands in (A), with gray and black regions showing other topologies and missing data.

used to reconstruct the macaque species tree based on the 26 633 SNV-fragment trees, which generated similar results

except for the position of Mfas_1 (*M. fascicularis* specimen from China) (Figure 2A, B). Our general topology conforms to

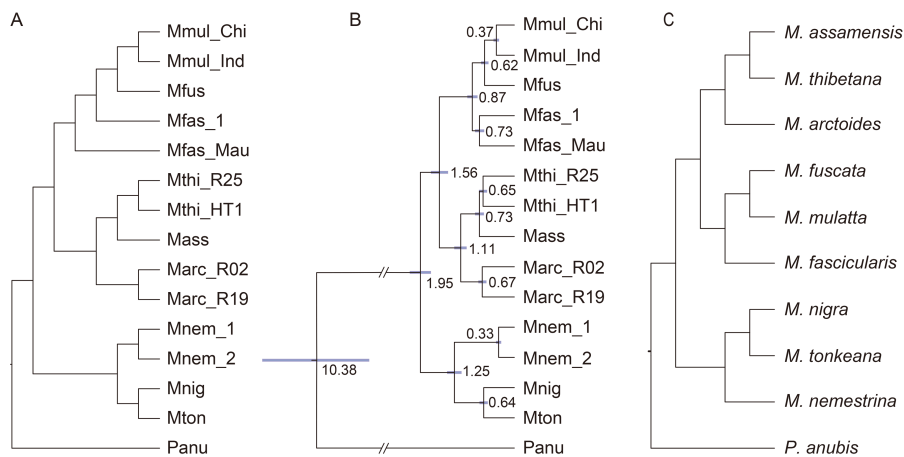

Figure 2 MSC (multispecies coalescent) tree

All node support values are 100%. A: MSC species tree generated from ASTRAL and MP-EST based on 26 633 SNV-fragments. B: Species tree with divergence time. Topology and divergence time were both estimated in SNAPP based on 20 000 SNV sites. This tree shows a conflict of Mfas_1 position with (A). Numbers on nodes indicate divergence time. Purple bars on nodes represent 95% confidence interval of divergence time. C: MSC tree at species level.

previous nuclear marker analyses of the phylogenetic relationships within *Macaca* (Fan et al., 2018; Jiang et al., 2016; Li et al., 2009). Here, the macaques clustered into three branches, corresponding to the *fascicularis* species group (*M. mulatta*, *M. fuscata*, and *M. fascicularis*), *sinica* species group (*M. thibetana*, *M. assamensis*, and *M. arctoides*), and *silenus* species group (*M. nemestrina*, *M. nigra*, and *M. tonkeana*) (Figure 2C). With respect to the position of Mfas_1, it was either grouped by itself at the basal node of *M. mulatta* and *M. fuscata* by ASTRAL and MP-EST (Figure 2A) or grouped with Mfas_Mau (*M. fascicularis* specimen from Mauritius) by SNAPP (Figure 2B). The estimated quartet scores for these two clusters were 0.4208 (ASTRAL and MP-EST) and 0.4047 (SNAPP), which are too close to describe the position of Mfas_1 accurately. A similar phylogenetic inconsistency was also observed following CONSENSE (Felsenstein, 1989) analysis of the SNV-fragment trees. Although a majority-rule consensus tree (Supplementary Figure S2) confirmed the topology of the ASTRAL and MP-EST species tree (Figure 2A), the separate grouping of the two *M. fascicularis* specimens occurred 9 959 times, accounting for 37.39% of the 26 633 trees (Supplementary Table S4).

Divergence time was estimated based on 20 000 SNV sites (Figure 2B). The estimated divergence time of baboons and macaques was ~10.38 (95% CI: 9.30–11.51) Ma, congruent with previous reports (Abbott et al., 2013; Roos et al., 2019). The *silenus* and *fascicularis/sinica* species groups diverged ~1.95 (95% CI: 1.74–2.17) Ma, and the *fascicularis* and *sinica* species groups diverged ~1.56 (95% CI: 1.39–1.73) Ma.

Consensus network analysis of the SNV-fragment trees yielded cuboid structures of connecting alternative branches, thus indicating reticulate phylogenetic relationships among macaques (Figure 3). Cuboid structures mainly occurred in the *fascicularis* and *sinica* species groups at a threshold of 11%, thus indicating phylogenetic conflicts within/between the two species groups and potential interspecific gene flow. There was no cuboid structure in the net center, suggesting that the

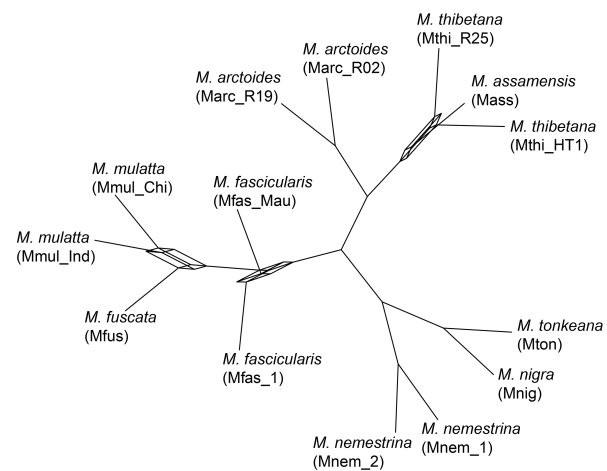

Figure 3 Consensus network of 26 633 SNV-fragment trees with 11% threshold

Cuboid structures mainly occur in *fascicularis* and *sinica* species groups, indicating phylogenetic conflicts in these two species groups and potential interspecific gene flow. There is no cuboid structure in the net center, indicating that the evolutionary relationship of ancestral macaques is relatively clear.

evolutionary relationship of ancestral macaques is relatively clear. At lower thresholds, the phylogenetic signal became more complex, and a cuboid structure appeared in the center of the net, thus implying additional phylogenetic conflict (Supplementary Figure S3).

Gene flow analyses

Both *D* and *D*_{FOIL} analyses identified substantial gene flow signals among macaques (Figure 4; Supplementary Tables S5, S6). The gene flow signals detected by the *D* statistic (corrected *P* < 0.001) at the individual and species level are shown in Figure 4A, B, respectively. Most species pairs showed significant gene flow signals, with strong signals

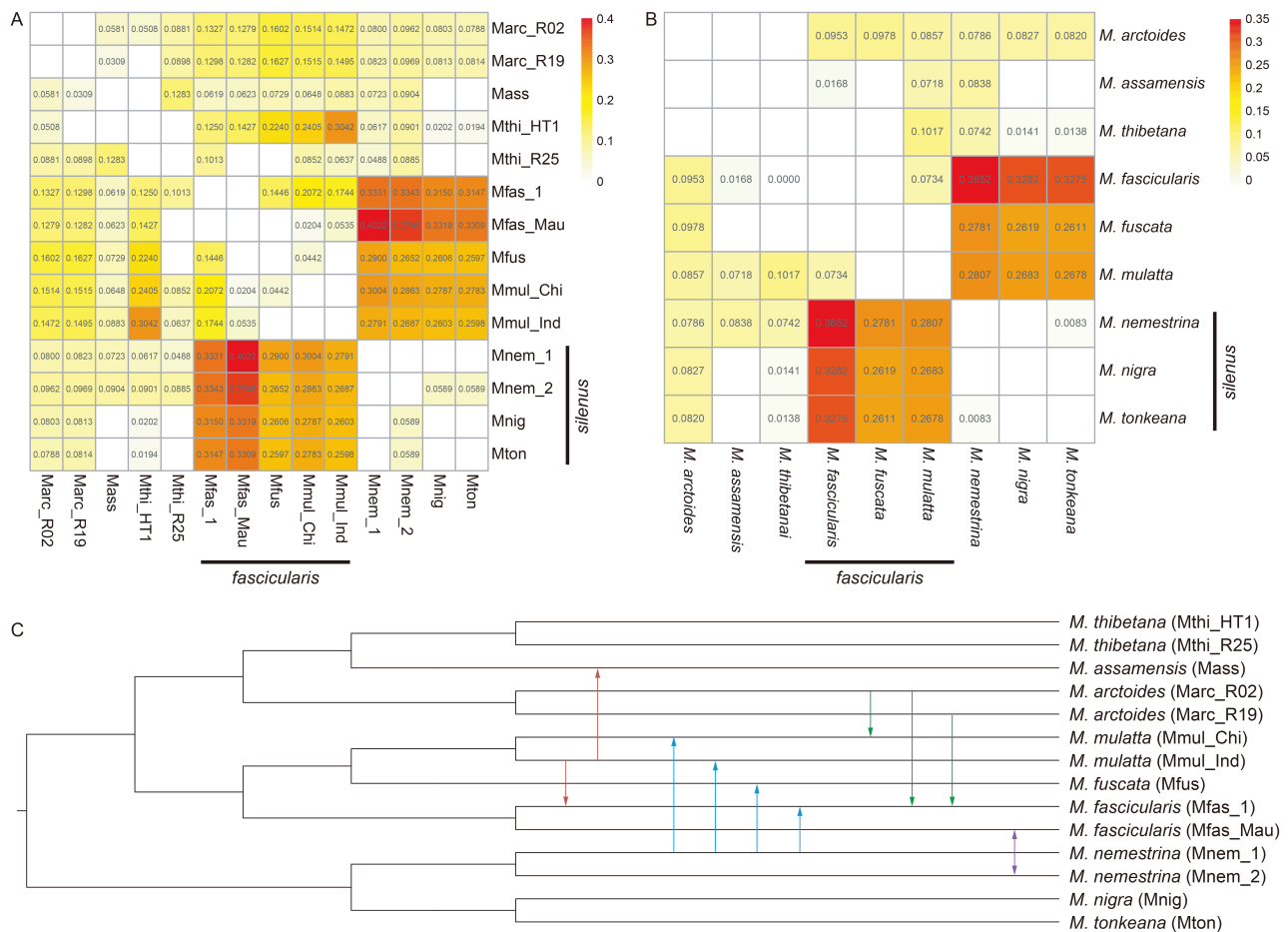

Figure 4 Gene flow signals in macaques

A: Gene flow identified by D statistic (corrected $P < 0.001$) at individual level. Numbers in grids represent D values, with higher values indicating higher introgression level. Grids without numbers indicate that no gene flow signal was detected. Redder colors indicate higher D statistics. Maximum D value of each individual pair was used for drawing. B: Gene flow identified by D statistic (corrected $P < 0.001$) at species level. The meanings of color and number in grid are the same as that in (A). Maximum D value of each species pair was used for drawing. C: Species tree of macaques with directional gene flow signals. Only signals confirmed by both D and D_{FOIL} statistics are shown here. Arrows indicate direction of gene flow.

detected in all species pairs between the *fascicularis* species group (*M. fascicularis*, *M. fuscata*, *M. mulatta*) and *silenus* species group (*M. nemestrina*, *M. nigra*, *M. tonkeana*). D_{FOIL} analyses identified the direction of gene flow signals between the 11 individual pairs (Supplementary Table S6). Ten of these signals were significant according to both D and D_{FOIL} statistical analyses. We mapped the direction of these gene flow signals in the species tree (Figure 4C). Unidirectional gene flow signals were found from *M. mulatta* to *M. assamensis* and *M. fascicularis*, from *M. nemestrina* to *M. fuscata* and *M. mulatta*, and from *M. arctoides* to *M. mulatta* and *M. fascicularis*. A bidirectional gene flow signal was detected between Mauritian *M. fascicularis* and Bornean *M. nemestrina*.

Different introgression signals were observed in individuals from different populations of the same species. For instance, the Anhui *M. thibetana* (Mthi_HT1) had an introgression signal with *M. fuscata*, but the Guangxi *M. thibetana* (Mthi_R25) did not have this signal. Different individuals of *M. fascicularis* and

M. nemestrina also showed different introgression signals (Figure 4A, C). Mfas_1 (a captive breed specimen collected from China, *M. fascicularis*) showed introgression signals with the Guangxi *M. thibetana* (Mthi_R25) and *M. fuscata* specimens, while the Mauritian *M. fascicularis* specimen (Mfas_Mau) did not show these signals (Figure 4A). Mnem_2 (specimen from Borneo, *M. nemestrina*) showed a significant introgression signal with *M. nigra* and *M. tonkeana*, but Mnem_1 (specimen of *M. nemestrina*) did not (Figure 4A).

The fraction of the genomes shared through gene flow was estimated using f_d (Martin et al., 2015) (Figure 5). The *M. fascicularis* and *M. nemestrina* species pair generated the highest f_d value (0.0619). In addition, the f_d values of species pairs between the *fascicularis* and *silenus* species groups (0.0239–0.0619) were higher than that of the other species pairs. The *M. fascicularis* and *M. mulatta* species pair also generated a relatively high f_d value (0.0240).

In addition to analyses based on site patterns, gene flow was investigated by topology-based analyses using

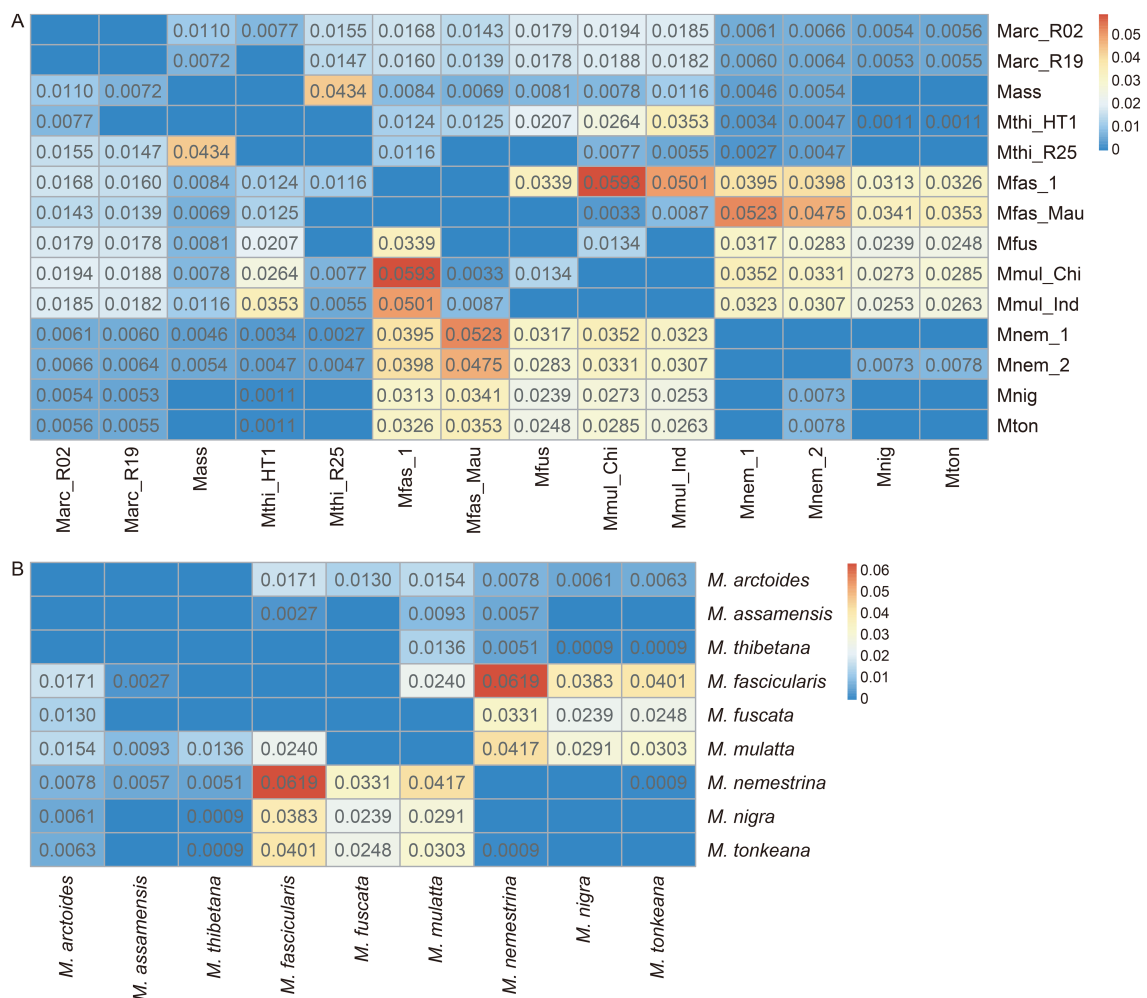

Figure 5 Proportion of genome shared through gene flow estimated by f_d statistic at (A) individual level and (B) species level

Number in grid is value of f_d . Grids without numbers indicate that no gene flow signal was detected. The f_d values of species pairs between *fascicularis* and *silenus* species groups were higher than that of other species pairs, with *M. fascicularis* and *M. nemestrina* species pair showing highest f_d value. In addition, *M. fascicularis* and *M. mulatta* species pair showed a high f_d value.

PhyloNetworks (Solís-Lemus et al., 2017) and PhyloNet (Wen et al., 2018). Consistent with the D and D_{FOIL} results, gene flow signals were identified between the *fascicularis* and *silenus* species groups (Figure 6; Supplementary Figures S4, S5). Different maximum numbers of reticulations (0–6) were set when estimating networks using PhyloNetworks. We generated seven phylogenetic networks, each with a network score (lower score indicates better network). Networks with the maximum number of reticulations set to six had the lowest score (Figure 6B). However, networks with five or six reticulations (Supplementary Figure S6) could not be re-rooted by *P. anubis* due to hybrid edges on the *P. anubis* branch. Therefore, we only presented phylogenetic networks with four reticulations, which had the lowest score next to networks with five and six reticulations. PhyloNetworks identified gene flow signals between the following pairs: *fascicularis* and *silenus* species group, *M. fuscata* and Chinese *M. mulatta*, two individuals of *M. fascicularis*, and unsampled species and Anhui *M. thibetana* (Figure 6A). PhyloNetworks also determined the proportion of genes inherited via gene flow

between these pairs (Figure 6A). For the ancestral lineage of the *fascicularis* species group, 39.5% of genes were from an ancestor of the *silenus* species group. Furthermore, 33.2% of *M. fuscata* genes were from Chinese *M. mulatta* and 23.2% of Anhui *M. thibetana* genes were from an unsampled species. In addition, PhyloNet identified several gene flow signals between the *fascicularis* and *sinica* (*M. arctoides*, *M. assamensis*, *M. thibetana*) species groups (Supplementary Figures S4, S5).

Given that strong introgression signals appeared in all species pairs between the *fascicularis* and *silenus* species groups, we compared the top 5% of windows showing the strongest introgression signals of several species pairs to determine if these signals reflected hybridization between the examined extant species after all dichotomous divergence events. These windows showed similar genomic distributions among the species pairs (Figure 7; Supplementary Figure S7). An example distribution of these windows across chromosome 18 is shown in Figure 7. In total, the proportion of shared top 5% of windows was 60.14%–67.93% for the *M. fascicularis*-

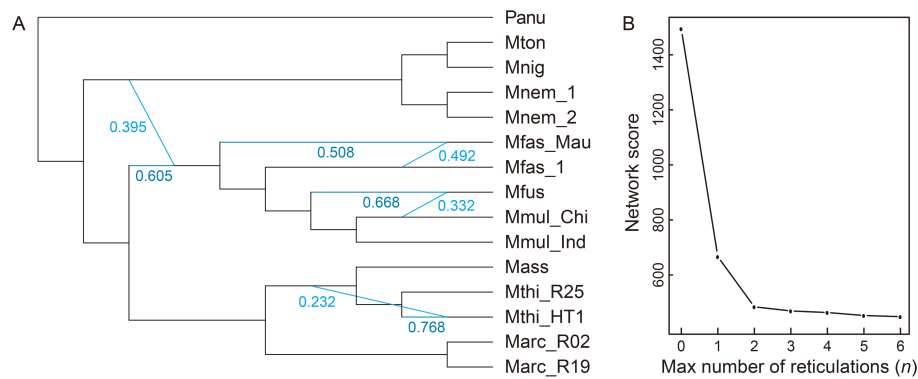

Figure 6 Rooted network of macaques

A: Rooted network of macaques with four reticulations inferred by PhyloNetworks based on 26 633 SNV-fragments. Hybrid edges are annotated with their inheritance values, which measure proportion of genes inherited via gene flow. B: Network scores based on different maximum number of reticulations (0–6). We estimated networks with a different maximum number of reticulations, and each generated a network score, with lower scores indicating better networks. However, networks with five and six reticulations could not be re-rooted by *P. anubis* due to hybrid edges on the *P. anubis* branch. Therefore, only the network with four reticulations is shown here.

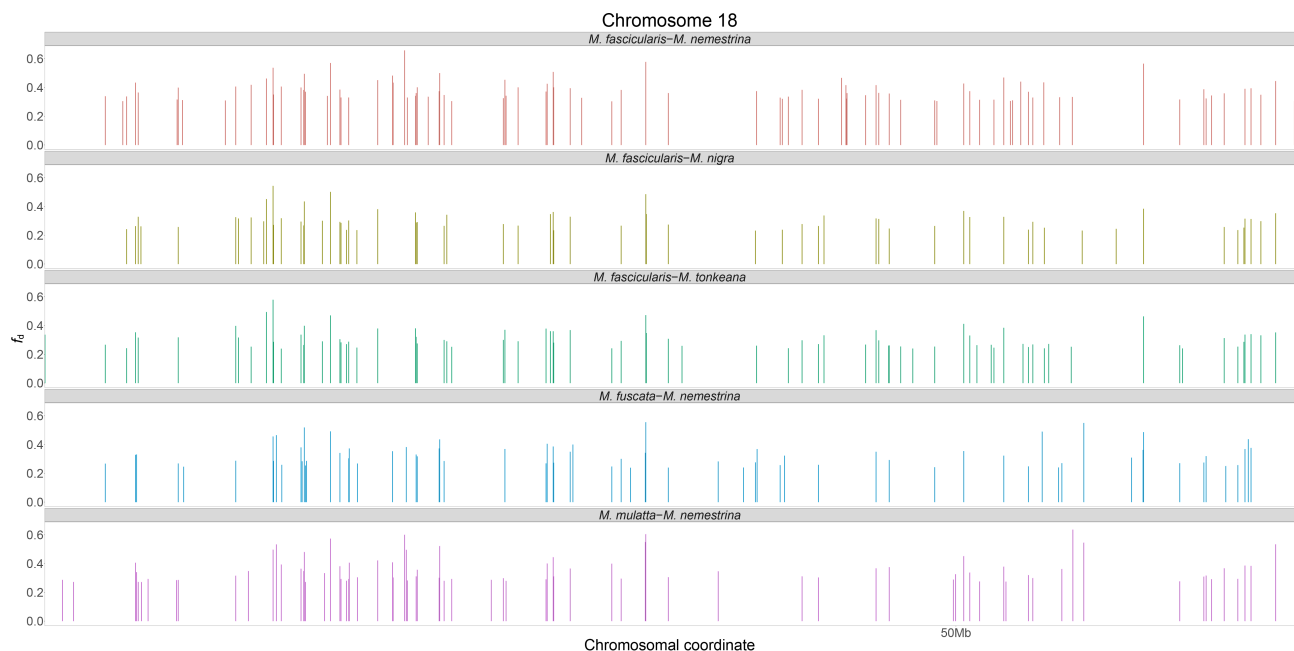

Figure 7 Distribution of top 5% of windows with strongest introgression signals according to f_d across chromosome 18

Species of species pairs belong to *fascicularis* and *silenus* species groups. Results showed that top 5% of windows with strongest introgression signals for different species pairs had similar genomic distributions.

silenus group species pairs and 45.84%–47.33% for the *M. nemestrina*-*fascicularis* group species pairs. The windows specific to each species pair only accounted for 8.70%–21.43% (Table 3).

There were 893 genes located in the top 5% of autosomal windows of the *M. fascicularis*-*M. nemestrina* species pair. Enrichment analysis (Supplementary Tables S7) showed that there were no enriched terms related to fertilization or reproduction. This implies that introgression may not have contributed to the formation of reproductive isolation.

Genetic diversity and demographic history

Genetic diversity was assessed using individual

heterozygosity. Genome-wide heterozygosity varied considerably among macaques, ranging from 0.000 363 to 0.002 971 (Table 2; Supplementary Figure 8A). Average heterozygosity was lowest for *M. thibetana* (0.000 551) and highest for *M. nemestrina* (0.002 829).

The historical effective population sizes (N_e) of macaques were modeled from the distribution of heterozygous sites across the genome using PSMC analysis (Li & Durbin, 2011) (Figure 8B–D; Supplementary Figure S8). The ancestral effective population sizes for all macaques were almost the same and all experienced a bottleneck ~5 Ma. After that, the N_e of most macaques increased gradually, although that of *M. nigra* remained relatively stable. The *M. thibetana* population

Table 3 Statistics on top 5% of windows with strongest introgression signals based on f_d for species pairs between *fascicularis* and *silenus* species groups

	Species pair	No. of top 5% windows	No. of shared windows	Percentage of shared windows	No. of specific windows	Percentage of specific window
<i>M. fascicularis-silenus</i> group species	<i>M. fascicularis</i> - <i>M. nemestrina</i>	2 920	1 756	60.14	378	12.95
	<i>M. fascicularis</i> - <i>M. nigra</i>	2 585		67.93	225	8.70
	<i>M. fascicularis</i> - <i>M. tonkeana</i>	2 814		62.40	257	9.13
<i>M. nemestrina-fascicularis</i> group species	<i>M. fascicularis</i> - <i>M. nemestrina</i>	2 920	1 382	47.33	378	12.95
	<i>M. fuscata</i> - <i>M. nemestrina</i>	3 015		45.84	646	21.43
	<i>M. mulatta</i> - <i>M. nemestrina</i>	2 999		46.08	446	14.87

For *M. fascicularis-silenus* group species pairs, 60.14%–67.93% of top 5% of windows were shared, and this proportion for *M. nemestrina-fascicularis* group species pairs was 45.84%–47.33%. Windows specific to each species pair only accounted for 8.70%–21.43%.

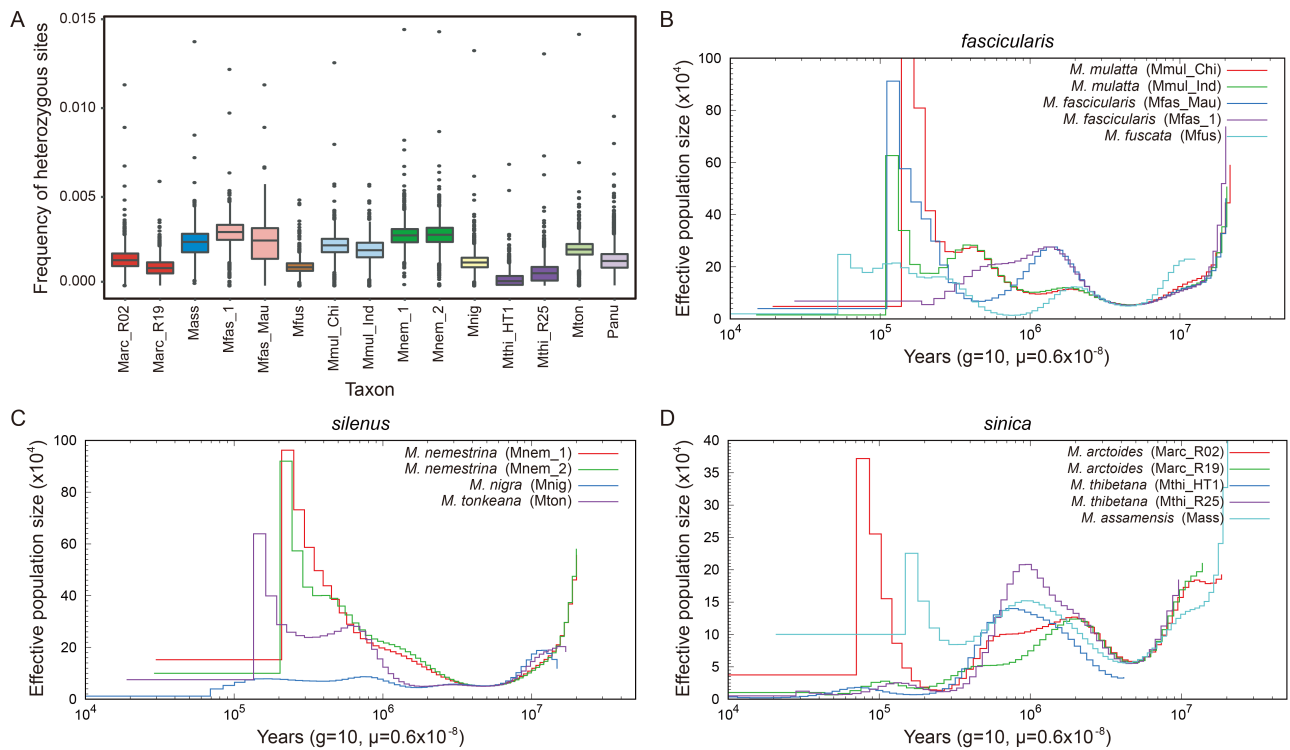

Figure 8 Genome-wide heterozygosity and demographic history

A: Genome-wide heterozygosity estimated from non-overlapping 1 Mb windows. B–D: Historical effective population sizes (N_e) of *fascicularis*, *silenus*, and *sinica* species groups. X-axis represents time; Y-axis represents N_e . Plots were scaled using a mutation rate (μ) of 0.58×10^{-8} bp⁻¹ generation⁻¹ and a generation time (g) of 10.

was largest ~0.80 Ma, after which it decreased. The *M. arctoides* population was largest ~2 Ma and declined thereafter. The variation trend of the *M. assamensis* population was similar to that of *M. thibetana*, but more gradual. The *M. mulatta* population increased after 5 Ma until 0.13 Ma, but there were two slight declines during the increasing period. The *M. fascicularis* population reached its largest size ~1.30 Ma, and then declined. The *M. fuscata* population remained small after 5 Ma, with small fluctuations. The *M. nemestrina* population increased from 5 Ma until

0.20 Ma. The *M. tonkeana* population remained small from 5 Ma to 1.70 Ma, and then increased to its peak at ~0.13 Ma.

DISCUSSION

Phylogeny of macaques

Our genome-wide-based multispecies coalescent phylogenetic tree shows a topology consistent with previous research based on nuclear markers and genome-wide data (Deinard & Smith, 2001; Fan et al., 2018; Jiang et al., 2016; Li

et al., 2009). The reconstructed species tree (Figure 2C) supported the classification of both the four and seven species groups, the differences simply being different hierarchical classifications of the macaques. The two *M. fascicularis* specimens had inconsistent positions in the phylogenetic trees when we used different software (Figure 2A, B). The quartet scores supporting the two phylogenetic topologies were very close (0.420 8 and 0.404 7). CONSENSE analysis separately grouped the two *M. fascicularis* specimens in 37.39% of the 26 633 trees. These results imply that distinct genetic backgrounds exist between the two *M. fascicularis*. Mfas_1 was a captive bred individual from China not within its natural range (Ito et al., 2020; Osada et al., 2021; Trask et al., 2013) and may have been introduced from nearby countries such as Vietnam and Thailand. As reported previously, unidirectional introgression hybridization from Chinese *M. mulatta* to Indochinese *M. fascicularis* has played an important role in the formation of the Indochinese *M. fascicularis* genome (Stevison & Kohn, 2009; Tosi & Coke, 2007; Yan et al., 2011). The Mfas_1 genome may carry fragments originally from *M. mulatta* and the mosaic genome may result in a closer phylogenetic relationship between Mfas_1 and *M. mulatta* than its conspecific Mfas_Mau (Figure 2A).

It should be noted that our samples included not only wild-caught macaques but also captive-bred and unknown-origin samples (e.g., Mfas_1 and Mnem_1). Therefore, certain results regarding these two samples may not necessarily be conclusive. Further studies that include only wild-caught *Macaca* individuals are necessary to confirm our results.

Reticulate evolution in macaques

Phylogenetic inconsistencies among different markers are signals of complex evolutionary history and should not be ignored when analyzing genome fragments longer than 25 kb (Kumar et al., 2017; Nakhleh, 2013). There are many possible reasons for phylogenetic conflict, such as mutation, drift, selection, ILS, and hybridization (Nakhleh, 2013). Our genome-wide analyses showed that the local evolutionary histories of various genomic regions in the macaques were significantly different (Figure 1). Coalescent-based analyses of whole-genome sequences and network analyses also indicated that the macaque genomes were characterized by contradictory genealogies (Figures 2, 3, 6). Consensus network and gene flow analyses also suggested a reticulate evolutionary history of macaques (Figures 3–6). Phylogenetic networks provide a better model than trees for capturing reticulate evolutionary history (Nakhleh, 2013). Macaque evolution appears to be a process of gradual divergence with complex gene flow. Therefore, the divergence of macaques is best understood as a phylogenetic network. This may be a reason why the evolution of macaques has been reconstructed differently in published studies (Fan et al., 2017; Jiang et al., 2016; Li et al., 2009; Li & Zhang, 2005).

Reticulate evolutionary relationships have also been found in other mammals (Árnason et al., 2018; Figueiro et al., 2017; Kumar et al., 2017), as well as in birds (Zhang et al., 2017), fish (Gante et al., 2016), amphibians (Pabijan et al., 2017), reptiles (Barley et al., 2019), and insects (Edelman et al., 2019). Therefore, speciation with genetic exchange is

common in animals, and should be viewed as a selective process that maintains species divergence even under gene flow (Kumar et al., 2017; Lexer & Widmer, 2008; Nosil, 2008).

Although we used a variety of software that consider ILS in gene flow analysis, ILS is an important factor that can lead to incongruences between gene trees or between gene and species trees and may not be completely ruled out. If several speciation events have occurred in one lineage within a relatively short time, different alleles may eventually fix in different descendant lineages, leading to incongruences as mentioned above. ILS is an important factor in evolutionary history but was unexamined in this study. Future studies including ILS analysis are necessary to improve our understanding of the evolutionary history of *Macaca*.

Signals of gene flow

Various macaque hybridization studies based on different molecular markers (e.g., autosome, mtDNA, Y chromosome, and genome-wide) and morphological characteristics have been published (Evans et al., 2017; Fan et al., 2014, 2018; Hamada et al., 2016; Ito et al., 2020; Jiang et al., 2016; Matsudaira et al., 2018; Osada et al., 2021; Rovie-Ryan et al., 2021; Tosi et al., 2000, 2003a, 2003b; Vanderpool et al., 2020; Yan et al., 2011), which suggest complicated gene flow patterns in macaques. However, most previous studies have focused on intragroup patterns or on the *fascicularis* and *sinica* species groups, e.g., between *M. mulatta* and *M. fascicularis* (Hamada et al., 2016), and proto-*M. fascicularis aurea* and *sinica* species group (Matsudaira et al., 2018). However, there is limited information about gene flow between the *silenus* group and other species within the genus *Macaca*.

Here, we analyzed more *Macaca* species, including three species from the *silenus* group, and found strong introgression signals in all species pairs between the *fascicularis* and *silenus* groups. In particular, *D* analysis confirmed the strongest introgression signals between *M. nemestrina* and *M. fascicularis* (Figure 4B). These two species have a wide geographical distribution overlap (Ang et al., 2020; Eudey et al., 2020; Roos et al., 2014), and natural hybridization events have been reported by field observation (Bernsteil, 1966). A recent study on the reference genomes of *M. nemestrina*, *M. fascicularis*, and *M. mulatta* also indicated strong gene flow signals among them (Vanderpool et al., 2020), consistent with our results. However, the previous study included only three macaque species, whereas our genome-wide analyses were based on multiple species and population samples from *silenus* and *fascicularis* species groups, which indicated that *M. nemestrina*-*M. fascicularis* showed the strongest introgression signal among all species pairs (Figure 4B). The signal between *M. nemestrina* and *M. fascicularis* is most likely caused by ancient hybridization events between the two species after their dichotomous divergence. We further estimated that the proportion of genome inherited via gene flow between the two species was 6.19% (f_d statistic; Figure 5A).

We also noted that species pairs between the *fascicularis* and *silenus* species groups, namely *M. fascicularis*-*M. nigra*/*M. tonkeana* and *M. fuscata*/*M. mulatta*-*M. nemestrina*, showed slightly weaker introgression signals than *M.*

nemestrina-*M. fascicularis*. Other species pairs from these two groups, namely *M. nigra*-*M. fuscata*/*M. mulatta* and *M. tonkeana*-*M. fuscata*/*M. mulatta*, showed the weakest introgression signals (Figure 4B). These findings indicate weaker introgression signals between species pairs that have more distant phylogenetic relationships with *M. nemestrina* or *M. fascicularis*. Furthermore, considering the non-overlapping distribution of species in other species pairs, excluding *M. nemestrina*-*M. fascicularis*, we suspect that introgression signals between the *fascicularis* and *silenus* species groups may be largely due to the similarity of genomes of closely related species, especially for insular species such as *M. tonkeana*, *M. nigra*, and *M. fuscata*, for instance, introgression signals between the two Sulawesi macaques (*M. tonkeana* and *M. nigra*) and the *fascicularis* species group. The two Sulawesi macaques are restricted to Sulawesi island and have no current distribution overlap with other macaques. However, previous studies have suggested that Bornean *M. nemestrina* expanded eastwards and reached Sulawesi, most likely by natural rafting, and diverged into numerous distinct Sulawesi species about 1.9–2.0 Ma (Meijaard, 2003; Ziegler et al., 2007). Sulawesi macaques thus share many genomic similarities with Bornean *M. nemestrina*. Owing to the strong introgression between *M. nemestrina* and *M. fascicularis*, the introgression signals detected between the *fascicularis* group and two Sulawesi macaques are most likely attributed to the genomic similarity of the closely related species. Similar to the Sulawesi macaques, introgression signals between *M. fuscata* and the *silenus* species group are probably due to the genomic similarity of *M. fuscata* to the Chinese *M. mulatta*, which both belong to the *fascicularis* species group (Chu et al., 2007). In addition, approximately 60.14%–67.93% of the top 5% of windows for the *M. fascicularis*-*silenus* group species pairs, and 45.84%–47.33% for the *M. nemestrina*-*fascicularis* group species pairs were shared (Table 3). These high ratios of shared windows confirmed that the introgression signals detected between Sulawesi macaques and the *fascicularis* group species, and between *M. fuscata* and the *silenus* group species are most likely due to genomic similarity, rather than hybridization after all dichotomous divergence events.

However, genomic similarity does not seem to be the cause of the introgression signal between Mauritian *M. fascicularis* (Mfas_Mau) and Bornean *M. nemestrina* (Mnem_2), which showed a bidirectional introgression signal, as detected by D_{FOIL} (Figure 4C). Mauritius is over 6 600 km from Borneo and naturally occurring introgression between these species seems impossible, implying that the introgression signal between them is most likely from an ancient hybridization event. *Macaca fascicularis* was introduced to Mauritius by the Portuguese in the 16th century (Tosi & Coke, 2007), with possible origin from Sumatra, Java, or Peninsular Malaysia (Tosi & Coke, 2007). Therefore, the gene flow signal between Mauritian *M. fascicularis* and Bornean *M. nemestrina* mirrors the gene flow between Bornean *M. nemestrina* and *M. fascicularis* from Sumatra, Java, or Peninsular Malaysia. Sumatra, Java, Peninsular Malaysia, and Borneo were connected during most of the Pleistocene due to lower sea levels (Louys & Turner, 2012). The connection of these

islands provided avenues for hybridization. As the bidirectional signal was only detected in one of the two *M. nemestrina*, there must have been a hybridization event after divergence of the two populations, i.e., after 0.33 Ma according to our divergence time estimation (Figure 2B).

It should be noted that there may be another explanation for the strong hybridization signals between the *fascicularis* and *silenus* species groups. For example, introgression may have occurred between ancestral lineages of these two species groups, and these signals were eventually retained in different descendant lineages. This explanation is consistent with the PhyloNetworks findings (Figure 6). The observed hybridization pattern may result in a similar distribution of hybridization signals across genomes among species pairs, consistent with Figure 7. It is also possible that ancestral hybridization and hybridization after divergence both occurred, which would make it difficult to determine all hybridization events correctly (Vanderpool et al., 2020). Studies with more species, larger sample sizes, and modeling analyses will allow detection of a more complex evolutionary history and clarification of any separate hybridization events.

Our study also detected introgression signals congruous with previous studies. Hybridization between *M. fascicularis* and *M. mulatta* has been extensively reported and there is a postulated hybrid zone (Hamada et al., 2016; Ito et al., 2020; Yan et al., 2011). Here, D analysis also detected a significant signal between these species. Similar to previously reported gene flow between *M. thibetana* and Chinese *M. mulatta* (Fan et al., 2014), our results also suggested a significant gene flow signal between these two lineages. Additionally, we detected a significant introgression signal between *M. thibetana* and Indian *M. mulatta*. Given the non-overlapping geographical distributions of these two lineages, the introgression signal is probably a result of genomic similarity between the Chinese and Indian *M. mulatta* or ancestral introgression.

Previous research has suggested that ~30% of the Vietnamese *M. fascicularis* genome is of Chinese *M. mulatta* origin, and ~8.84% of the *M. thibetana* genome contains putative introgression regions when compared to Chinese *M. mulatta* (Fan et al., 2014; Yan et al., 2011). According to our estimations, the proportion of introgression reached 5.93% for *M. fascicularis* and Chinese *M. mulatta*, and 3.53% for *M. thibetana* and *M. mulatta* (Figure 5A). As f_d is a conservative estimator, the proportion of genome shared through gene flow may be underestimated (Martin et al., 2015). Although the amount of introgression varied between the f_d statistic and other estimators, we still obtained the approximate proportions of introgression (Martin et al., 2015), which allow us to compare the degree of hybridization between different species.

Recent introgression signals in different populations

In our study, individuals from five species originated from different populations, which allows for the assessment of introgression after the divergence of different populations. Surprisingly, introgression signals varied in the different populations of all five species (Figure 4A, C). This phenomenon has also been reported in *M. mulatta*, *M. fascicularis*, and *M. arctoides* (Fan et al., 2018; Osada et al.,

2021; Rovie-Ryan et al., 2021). These results suggest that gene flow occurred after the split of populations, and thus may be very recent. Although morphological characteristics, genital structure, and sexual behavior differ significantly among macaque species, the chromosome karyotypes of macaques are very similar, and hybrid offspring of *Macaca* are fertile (Bunlungsup et al., 2017; Ciani et al., 1989; Evans et al., 2017; Hamada et al., 2012; Yang & Shi, 1994). The results of our research and previous studies suggest that gene flow among macaques is an ongoing process, and there is incomplete reproductive isolation. Therefore, hybridization occurs between different sympatric macaques.

Genetic diversity and demographic history of macaques

The heterozygosity of *M. thibetana* was the lowest among macaques, with a similar level as the endangered snub-nosed monkeys (0.015%–0.068%) (Zhou et al., 2016). Previous study also reported a lower genome-wide heterozygosity of *M. thibetana* (0.0898%) than of *M. fascicularis* (0.3004%–0.3179%) and *M. mulatta* (0.2612%–0.2617%) (Fan et al., 2018). The heterozygosity of the other macaques is higher than that of humans (0.08%–0.12%) and great apes (0.065%–0.178%) (Prado-Martinez et al., 2013). The high heterozygosity of macaques is consistent with their widespread distribution (Roos et al., 2019).

We reconstructed the demographic histories of nine species of *Macaca* using PSMC. Fluctuation in demographic history is usually considered to be from adaptations to changes in the environment and climate. The varied and complicated fluctuation patterns in the different macaque species suggested that they experienced different environmental variation and climate change. According to our study, all macaques went through a bottleneck ~5 Ma. This bottleneck may indicate the ancestral population of all Asian macaques when they first arrived in Eurasia (Roos et al., 2019). The bottleneck may be due to the long-term cooling, drying, and even formation of the ephemeral Northern Hemisphere glaciations between 6.0 and 5.5 Ma during the late Miocene (Holbourn et al., 2018). Subsequent increases in population sizes may have been in response to the warm and wet early Pliocene climates (Sniderman et al., 2016). A similar bottleneck has also been identified in other studies (Fan et al., 2014, 2018; Liu et al., 2018). After the bottleneck, macaques underwent differentiation and radiation. Inconsistent demographic historical dynamics were produced when adapting to different environments and climate. Overall, these findings strongly indicate that the population sizes of macaques varied differently and considerably during the Pliocene and Pleistocene, with successive fluctuations likely resulting in different genetic diversity between these lineages.

CONCLUSIONS

Our genome-wide analyses covered all species groups of Asian macaques. We found that complex introgressive gene flow played an important role in the evolutionary history of *Macaca*, and the evolution of macaques should be more accurately understood as phylogenetic networks rather than trees. Introgression signals between the *fascicularis* and *silenus* species groups were the strongest of all signals

detected. In particular, bidirectional gene flow occurred between Mauritian *M. fascicularis* and Bornean *M. nemestrina*. However, introgression signals between the island species (e.g., Sulawesi macaques and *M. fuscata*) and other species may be attributed to genomic similarities between closely related species or ancestral introgression. Different introgression signals in different populations of the same species suggest that gene flow in macaques is likely to be an ongoing process. In conclusion, our study provides comprehensive insight into gene flow in macaques from a genome-wide perspective. However, the contribution of high-level introgression to adaptive history in macaque species remains unclear and is worthy of further study with more extensive population sampling.

SUPPLEMENTARY DATA

Supplementary data to this article can be found online.

COMPETING INTERESTS

The authors declare that they have no competing interests.

AUTHORS' CONTRIBUTIONS

J.L. and Z.X.F. designed the research. J.L. and Y.S. collected the samples. Y.S. and C.J. performed the experiments. Y.S., J.L., K.H.L., and H.Q. contributed to data analysis. Y.S., Z.X.F., and J.L. wrote the manuscript. M.P. revised the manuscript and improved the language. All authors read and approved the final version of the manuscript.

ACKNOWLEDGEMENTS

We thank Song Wang at Nanning Zoo and Zhan-Long He at the Chinese Academy of Medical Sciences for their support in sample collection.

REFERENCES

- Abbott R, Albach D, Ansell S, Arntzen JW, Baird SJE, Bierne N, et al. 2013. Hybridization and speciation. *Journal of Evolutionary Biology*, **26**(2): 229–246.
- Ang A, Boonratana R, Choudhury A, Supriatna J. 2020. *Macaca nemestrina*. The IUCN Red List of Threatened Species 2020: e.T12555A181324867.
- Árnason U, Lammers F, Kumar V, Nilsson MA, Janke A. 2018. Whole-genome sequencing of the blue whale and other rorquals finds signatures for introgressive gene flow. *Science Advances*, **4**(4): eaap9873.
- Arnold ML, Meyer A. 2006. Natural hybridization in primates: one evolutionary mechanism. *Zoology (Jena)*, **109**(4): 261–276.
- Baiz MD, Tucker PK, Mueller JL, Cortés-Ortiz L. 2020. X-linked signature of reproductive isolation in humans is mirrored in a howler monkey hybrid zone. *Journal of Heredity*, **111**(5): 419–428.
- Barley AJ, de Oca ANM, Reeder TW, Manríquez-Morán NL, Monroy JCA, Hernández-Gallegos O, et al. 2019. Complex patterns of hybridization and introgression across evolutionary timescales in Mexican whiptail lizards (*Aspidoscelis*). *Molecular Phylogenetics and Evolution*, **132**: 284–295.
- Bernstein IS. 1966. Naturally occurring primate hybrid. *Science*, **154**(3756): 1559–1560.

- Bouckaert R, Heled J, Kühnert D, Vaughan T, Wu CH, Xie D, et al. 2014. BEAST 2: a software platform for Bayesian evolutionary analysis. *PLoS Computational Biology*, **10**(4): e1003537.
- Bryant D, Bouckaert R, Felsenstein J, Rosenberg NA, RoyChoudhury A. 2012. Inferring species trees directly from biallelic genetic markers: bypassing gene trees in a full coalescent analysis. *Molecular Biology and Evolution*, **29**(8): 1917–1932.
- Bunlungsup S, Kanthaswamy S, Oldt RF, Smith DG, Houghton P, Hamada Y, et al. 2017. Genetic analysis of samples from wild populations opens new perspectives on hybridization between long-tailed (*Macaca fascicularis*) and rhesus macaques (*Macaca mulatta*). *American Journal of Primatology*, **79**(12): e22726.
- Chen SF, Zhou YQ, Chen YR, Gu J. 2018. Fastp: an ultra-fast all-in-one FASTQ preprocessor. *Bioinformatics*, **34**(17): i884–i890.
- Chu JH, Lin YS, Wu HY. 2007. Evolution and dispersal of three closely related macaque species, *Macaca mulatta*, *M. cyclopis*, and *M. fuscata*, in the Eastern Asia. *Molecular Phylogenetics and Evolution*, **43**(2): 418–429.
- Ciani AC, Stanyon R, Scheffrahn W, Sampurno B. 1989. Evidence of gene flow between Sulawesi macaques. *American Journal of Primatology*, **17**(4): 257–270.
- Cortés-Ortiz L, Duda Jr TF, Canales-Espinosa D, García-Orduña F, Rodríguez-Luna E, Bermingham E. 2007. Hybridization in large-bodied new world primates. *Genetics*, **176**(4): 2421–2425.
- Deinard A, Smith DG. 2001. Phylogenetic relationships among the macaques: evidence from the nuclear locus *NRAMP1*. *Journal of Human Evolution*, **41**(1): 45–59.
- Delson E. 1980. Fossil macaques, phyletic relationships and a scenario of deployment. In: Lindburg DG. *The Macaques: Studies in Ecology, Behavior and Evolution*. New York: Van Nostrand Reinhold.
- DePristo MA, Banks E, Poplin R, Garimella KV, Maguire JR, Hartl C, et al. 2011. A framework for variation discovery and genotyping using next-generation DNA sequencing data. *Nature Genetics*, **43**(5): 491–498.
- Edelman NB, Frandsen PB, Miyagi M, Clavijo B, Davey J, Dikow RB, et al. 2019. Genomic architecture and introgression shape a butterfly radiation. *Science*, **366**(6465): 594–599.
- Eudey A, Kumar A, Singh M, Boonratana R. 2020. *Macaca fascicularis* (Errata Version Published in 2021). The IUCN Red List of Threatened Species 2020: e.T12551A195354635.
- Evans BJ, Tosi AJ, Zeng K, Dushoff J, Corvelo A, Melnick DJ. 2017. Speciation over the edge: gene flow among non-human primate species across a formidable biogeographic barrier. *Royal Society Open Science*, **4**(10): 170351.
- Fan PF, Liu Y, Zhang ZC, Zhao C, Li C, Liu WL, et al. 2017. Phylogenetic position of the white-cheeked macaque (*Macaca leucogenys*), a newly described primate from southeastern Tibet. *Molecular Phylogenetics and Evolution*, **107**: 80–89.
- Fan ZX, Zhao G, Li P, Osada N, Xing JC, Yi Y, et al. 2014. Whole-genome sequencing of Tibetan macaque (*Macaca thibetana*) provides new insight into the macaque evolutionary history. *Molecular Biology and Evolution*, **31**(6): 1475–1489.
- Fan ZX, Zhou AB, Osada N, Yu JQ, Jiang J, Li P, et al. 2018. Ancient hybridization and admixture in macaques (genus *Macaca*) inferred from whole genome sequences. *Molecular Phylogenetics and Evolution*, **127**: 376–386.
- Felsenstein J. 1989. PHYLIP - phylogeny inference package (Version 3.2). *Cladistics*, **5**(2): 164–166.
- Figueiro HV, Li G, Trindade FJ, Assis J, Pais F, Fernandes G, et al. 2017. Genome-wide signatures of complex introgression and adaptive evolution in the big cats. *Science Advances*, **3**(7): e1700299.
- Fooden J. 1976. Provisional classification and key to living species of macaques (primates: *Macaca*). *Folia Primatologica*, **25**(2–3): 225–236.
- Gante HF, Matschiner M, Malmstrom M, Jakobsen KS, Jentoft S, Salzburger W. 2016. Genomics of speciation and introgression in princess cichlid fishes from Lake Tanganyika. *Molecular Ecology*, **25**(24): 6143–6161.
- Green RE, Krause J, Briggs AW, Maricic T, Stenzel U, Kircher M, et al. 2010. A draft sequence of the neandertal genome. *Science*, **328**(5979): 710–722.
- Groves C. 2001. *Primate Taxonomy*. Washington: Smithsonian Institution Press.
- Hamada Y, San AM, Malaivijitnond S. 2016. Assessment of the hybridization between rhesus (*Macaca mulatta*) and long-tailed macaques (*M. fascicularis*) based on morphological characters. *American Journal of Physical Anthropology*, **159**(2): 189–198.
- Hamada Y, Yamamoto A, Kunimatsu Y, Tojima S, Mouri T, Kawamoto Y. 2012. Variability of tail length in hybrids of the Japanese macaque (*Macaca fuscata*) and the taiwanese macaque (*Macaca cyclopis*). *Primates*, **53**(4): 397–411.
- Hoang DT, Chernomor O, von Haeseler A, Minh BQ, Vinh LS. 2018. UFBoot2: improving the ultrafast bootstrap approximation. *Molecular Biology and Evolution*, **35**(2): 518–522.
- Holbourn AE, Kuhnt W, Clemens SC, Kochhann KGD, Jöhnck J, Lübbers J, et al. 2018. Late Miocene climate cooling and intensification of southeast Asian winter monsoon. *Nature Communications*, **9**(1): 1584.
- Ito T, Kanthaswamy S, Bunlungsup S, Oldt RF, Houghton P, Hamada Y, et al. 2020. Secondary contact and genomic admixture between rhesus and long-tailed macaques in the Indochina Peninsula. *Journal of Evolutionary Biology*, **33**(9): 1164–1179.
- Ito T, Lee YJ, Nishimura TD, Tanaka M, Woo JY, Takai M. 2018. Phylogenetic relationship of a fossil macaque (*Macaca cf. robusta*) from the Korean peninsula to Extant species of macaques based on zygomaxillary morphology. *Journal of Human Evolution*, **119**: 1–13.
- Jiang J, Yu JQ, Li J, Li P, Fan ZX, Niu LL, et al. 2016. Mitochondrial genome and nuclear markers provide new insight into the evolutionary history of macaques. *PLoS One*, **11**(5): e0154665.
- Junier T, Zdobnov EM. 2010. The newick utilities: high-throughput phylogenetic tree processing in the UNIX shell. *Bioinformatics*, **26**(13): 1669–1670.
- Kalyaanamoorthy S, Minh BQ, Wong TKF, von Haeseler A, Jermin LS. 2017. ModelFinder: fast model selection for accurate phylogenetic estimates. *Nature Methods*, **14**(6): 587–589.
- Kubisch HM, Falkenstein KP, Deroche CB, Franke DE. 2012. Reproductive efficiency of captive Chinese- and Indian-origin rhesus macaque (*Macaca mulatta*) females. *American Journal of Primatology*, **74**(2): 174–184.
- Kuhlwil M, Han S, Sousa VC, Excoffier L, Marques-Bonet T. 2019. Ancient admixture from an extinct ape lineage into bonobos. *Nature Ecology & Evolution*, **3**(6): 957–965.
- Kumar V, Lammers F, Bidon T, Pfenninger M, Kolter L, Nilsson MA, et al. 2017. The evolutionary history of bears is characterized by gene flow across species. *Scientific Reports*, **7**: 46487.
- Lambert SM, Streicher JW, Fisher-Reid MC, de la Cruz FRM, Martínez-Méndez N, García-Vázquez UO, et al. 2019. Inferring introgression using

- RADseq and D_{FOIL}: Power and pitfalls revealed in a case study of spiny lizards (*Sceloporus*). *Molecular Ecology Resources*, **19**(4): 818–837.
- Langmead B, Salzberg SL. 2012. Fast gapped-read alignment with bowtie 2. *Nature Methods*, **9**(4): 357–359.
- Lewis PO. 2001. A likelihood approach to estimating phylogeny from discrete morphological character data. *Systematic Biology*, **50**(6): 913–925.
- Lexer C, Widmer A. 2008. Review. The genic view of plant speciation: recent progress and emerging questions. *Philosophical transactions of the Royal Society B*, **363**(1506): 3023–3036.
- Li H. 2011. A statistical framework for SNP calling, mutation discovery, association mapping and population genetical parameter estimation from sequencing data. *Bioinformatics*, **27**(21): 2987–2993.
- Li H, Durbin R. 2011. Inference of human population history from individual whole-genome sequences. *Nature*, **475**(7357): 493–496.
- Li J, Han K, Xing JC, Kim HS, Rogers J, Ryder OA, et al. 2009. Phylogeny of the macaques (Cercopithecidae: *Macaca*) based on *Alu* elements. *Gene*, **448**(2): 242–249.
- Li QQ, Zhang YP. 2005. Phylogenetic relationships of the macaques (Cercopithecidae: *Macaca*), Inferred from mitochondrial DNA sequences. *Biochemical Genetics*, **43**(7–8): 375–386.
- Liu L, Yu LL, Edwards SV. 2010. A maximum pseudo-likelihood approach for estimating species trees under the coalescent model. *BMC Evolutionary Biology*, **10**: 302.
- Liu ZJ, Tan XX, Orozco-terWengel P, Zhou XM, Zhang LY, Tian SL, et al. 2018. Population genomics of wild Chinese rhesus macaques reveals a dynamic demographic history and local adaptation, with implications for biomedical research. *GigaScience*, **7**(9): giy106.
- Louys J, Turner A. 2012. Environment, preferred habitats and potential refugia for Pleistocene *Homo* in southeast Asia. *Comptes Rendus Palevol*, **11**(2–3): 203–211.
- Malinsky M, Matschiner M, Svoldal H. 2021. Dsuite - fast *D*-statistics and related admixture evidence from VCF files. *Molecular Ecology Resources*, **21**(2): 584–595.
- Martin SH, Davey JW, Jiggins CD. 2015. Evaluating the use of ABBA-BABA statistics to locate introgressed loci. *Molecular Biology and Evolution*, **32**(1): 244–257.
- Martin SH, Jiggins CD. 2017. Interpreting the genomic landscape of introgression. *Current Opinion in Genetics & Development*, **47**: 69–74.
- Matsudaira K, Hamada Y, Bunlungsup S, Ishida T, San AM, Malaivijitnond S. 2018. Whole mitochondrial genomic and Y-chromosomal phylogenies of burmese long-tailed macaque (*Macaca fascicularis aurea*) suggest ancient hybridization between *fascicularis* and *sinica* species groups. *Journal of Heredity*, **109**(4): 360–371.
- Meijaard E. 2003. Mammals of south-east Asian islands and their Late Pleistocene environments. *Journal of Biogeography*, **30**(8): 1245–1257.
- Nakhleh L. 2013. Computational approaches to species phylogeny inference and gene tree reconciliation. *Trends in Ecology & Evolution*, **28**(12): 719–728.
- Nguyen LT, Schmidt HA, von Haeseler A, Minh BQ. 2015. IQ-TREE: a fast and effective stochastic algorithm for estimating maximum-likelihood phylogenies. *Molecular Biology and Evolution*, **32**(1): 268–274.
- Nosil P. 2008. Speciation with gene flow could be common. *Molecular Ecology*, **17**(9): 2103–2106.
- Osada N, Matsudaira K, Hamada Y, Malaivijitnond S. 2021. Testing sex-biased admixture origin of macaque species using autosomal and x-chromosomal genomic sequences. *Genome Biology and Evolution*, **13**(1): evaa209.
- Pabijan M, Zieliński P, Dudek K, Stuglik M, Babik W. 2017. Isolation and gene flow in a speciation continuum in newts. *Molecular Phylogenetics and Evolution*, **116**: 1–12.
- Pease JB, Hahn MW. 2015. Detection and polarization of introgression in a five-taxon phylogeny. *Systematic Biology*, **64**(4): 651–662.
- Prado-Martinez J, Sudmant PH, Kidd JM, Li H, Kelley JL, Lorente-Galdos B, et al. 2013. Great ape genetic diversity and population history. *Nature*, **499**(7459): 471–475.
- Reimand J, Kull M, Peterson H, Hansen J, Vilo J. 2007. g:Profiler—a web-based toolset for functional profiling of gene lists from large-scale experiments. *Nucleic Acids Research*, **35**(S2): W193–W200.
- Rogers J, Raveendran M, Harris RA, Mailund T, Leppälä K, Athanasiadis G, et al. 2019. The comparative genomics and complex population history of *Papio baboons*. *Science Advances*, **5**(1): eaau6947.
- Roos C, Boonratana R, Supriatna J, Fellowes JR, Groves CP, Nash SD, et al. 2014. An updated taxonomy and conservation status review of Asian primates. *Asian Primates Journal*, **4**(1): 2–38.
- Roos C, Kothe M, Alba DM, Delson E, Zinner D. 2019. The radiation of macaques out of Africa: evidence from mitogenome divergence times and the fossil record. *Journal of Human Evolution*, **133**: 114–132.
- Rovie-Ryan JJ, Khan FAA, Abdullah MT. 2021. Evolutionary pattern of *Macaca fascicularis* in southeast Asia inferred using y-chromosomal gene. *BMC Ecology and Evolution*, **21**(1): 26.
- Schliep KP. 2011. Phangorn: phylogenetic analysis in R. *Bioinformatics*, **27**(4): 592–593.
- Sniderman JMK, Woodhead JD, Hellstrom J, Jordan GJ, Drysdale RN, Tyler JJ, et al. 2016. Pliocene reversal of late Neogene aridification. *Proceedings of the National Academy of Sciences of the United States of America*, **113**(8): 1999–2004.
- Solís-Lemus C, Bastide P, Ané C. 2017. PhyloNetworks: a package for phylogenetic networks. *Molecular Biology and Evolution*, **34**(12): 3292–3298.
- Stange M, Sánchez-Villagra MR, Salzburger W, Matschiner M. 2018. Bayesian divergence-time estimation with genome-wide single-nucleotide polymorphism data of sea catfishes (Ariidae) supports Miocene closure of the Panamanian isthmus. *Systematic Biology*, **67**(4): 681–699.
- Stevison LS, Kohn MH. 2009. Divergence population genetic analysis of hybridization between rhesus and *Cynomolgus* macaques. *Molecular Ecology*, **18**(11): 2457–2475.
- Tarailo-Graovac M, Chen NS. 2009. Using repeatmasker to identify repetitive elements in genomic sequences. *Current Protocols in Bioinformatics*, **25**(1): 4–10.
- Tosi AJ, Coke CS. 2007. Comparative phylogenetics offer new insights into the biogeographic history of *Macaca fascicularis* and the origin of the mauritian macaques. *Molecular Phylogenetics and Evolution*, **42**(2): 498–504.
- Tosi AJ, Disotell TR, Morales JC, Melnick DJ. 2003a. Cercopithecine y-chromosome data provide a test of competing morphological evolutionary hypotheses. *Molecular Phylogenetics and Evolution*, **27**(3): 510–521.
- Tosi AJ, Morales JC, Melnick DJ. 2000. Comparison of Y chromosome and mtDNA phylogenies leads to unique inferences of macaque evolutionary history. *Molecular Phylogenetics and Evolution*, **17**(2): 133–144.
- Tosi AJ, Morales JC, Melnick DJ. 2003b. Paternal, maternal, and biparental molecular markers provide unique windows onto the evolutionary history of macaque monkeys. *Evolution*, **57**(6): 1419–1435.

- Trask JAS, Garnica WT, Smith DG, Houghton P, Lerche N, Kanthaswamy S. 2013. Single-nucleotide polymorphisms reveal patterns of allele sharing across the species boundary between rhesus (*Macaca mulatta*) and cynomolgus (*M. fascicularis*) macaques. *American Journal of Primatology*, **75**(2): 135–144.
- Vanderpool D, Minh BQ, Lanfear R, Hughes D, Murali S, Harris RA, et al. 2020. Primate phylogenomics uncovers multiple rapid radiations and ancient interspecific introgression. *PLoS Biology*, **18**(12): e3000954.
- Wang RJ, Thomas GWC, Raveendran M, Harris RA, Doddapaneni H, Muzny DM, et al. 2020. Paternal age in rhesus macaques is positively associated with germline mutation accumulation but not with measures of offspring sociability. *Genome Research*, **30**(6): 826–834.
- Wen DQ, Yu Y, Zhu JF, Nakhleh L. 2018. Inferring phylogenetic networks using PhyloNet. *Systematic Biology*, **67**(4): 735–740.
- Woodruff DS. 2010. Biogeography and conservation in southeast Asia: how 2.7 million years of repeated environmental fluctuations affect today's patterns and the future of the remaining refugial-phase biodiversity. *Biodiversity and Conservation*, **19**(4): 919–941.
- Xue C, Raveendran M, Harris RA, Fawcett GL, Liu XM, White S, et al. 2016. The population genomics of rhesus macaques (*Macaca mulatta*) based on whole-genome sequences. *Genome Research*, **26**(12): 1651–1662.
- Yan GM, Zhang GJ, Fang XD, Zhang YF, Li C, Ling F, et al. 2011. Genome sequencing and comparison of two nonhuman primate animal models, the cynomolgus and Chinese rhesus macaques. *Nature Biotechnology*, **29**(11): 1019–1023.
- Yang FT, Shi LM. 1994. Studies of the mitotic chromosomes, meiosis and spermatogenesis of a macaque hybrid. *Acta Genetica Sinica*, **21**(1): 24–29. (in Chinese)
- Yang ZH. 2007. PAML 4: phylogenetic analysis by maximum likelihood. *Molecular Biology and Evolution*, **24**(8): 1586–1591.
- Zhang C, Rabiee M, Sayyari E, Mirarab S. 2018. ASTRAL-III: polynomial time species tree reconstruction from partially resolved gene trees. *BMC Bioinformatics*, **19**(S6): 153.
- Zhang DZ, Song G, Gao B, Cheng YL, Qu YH, Wu SY, et al. 2017. Genomic differentiation and patterns of gene flow between two long-tailed tit species (*Aegithalos*). *Molecular Ecology*, **26**(23): 6654–6665.
- Zhou XM, Meng XH, Liu ZJ, Chang J, Wang BS, Li MZ, et al. 2016. Population genomics reveals low genetic diversity and adaptation to hypoxia in snub-nosed monkeys. *Molecular Biology and Evolution*, **33**(10): 2670–2681.
- Ziegler T, Abegg C, Meijaard E, Perwitasari-Farajallah D, Walter L, Hodges JK, et al. 2007. Molecular phylogeny and evolutionary history of southeast Asian macaques forming the *M. silenus* group. *Molecular Phylogenetics and Evolution*, **42**(3): 807–816.
- Zinner D, Arnold ML, Roos C. 2011. The strange blood: natural hybridization in primates. *Evolutionary Anthropology: Issues, News, and Reviews*, **20**(3): 96–103.