

PATHWAYS OF CELLULAR MORPHOGENESIS

A Diversity in *Nitella*

PAUL B. GREEN

From the Department of Cytology, Dartmouth Medical School, and Department of Biological Sciences, Dartmouth College, Hanover, New Hampshire. Dr. Green's present address is Department of Biology, University of Pennsylvania, Philadelphia

ABSTRACT

Evidence is presented to show that a given change in cell form or size may generally be brought about by a variety of patterns of local surface distortion and expansion. Structural and chemical features of the cell which are important in morphogenesis may thus be expected to relate not to form *per se* but to the kinetics of surface behavior which establish form. These kinetics evaluate both the rate at which local regions of cell surface expand and the directed character (anisotropy) of this expansion. These variables have been studied in model systems and, through marking experiments, in growing cells of various shapes in *Phycomyces*, *Clypeaster*, and particularly *Nitella*. In the latter plant, prominent "giant internodes" display a well defined longitudinal anisotropic expansion devoid of sizeable gradients in expansion rate. These cells have their origin, however, in apical cells which have a pronounced gradient in area expansion rate (maximal at the tip). The great part of the expansion in the apical cell is apparently isotropic (equal in all directions), but the basal region often shows predominant expansion laterally. This transverse stretching in the apical cell could align cell wall texture and possibly fibrous cytoplasmic constituents, such as microtubules, into configurations significant in later morphogenetic stages, including the elongation of the internodes.

INTRODUCTION

When cells change their configuration or size, there are generally a number of ways in which the change could take place when the behavior of the various regions of the cell surface is considered. In other words, knowledge of the change in outline of the cell usually does *not* specify the kind of local changes that bring it about. In cells which are figures of revolution, zones or bands constitute convenient subdivisions of the cell surface. The development of form can be resolved into the local changes taking place in these zones. Description of the exact nature of the local changes reveals whether there is variation in the rate of area expansion along the cell surface and also whether there

is local variation in the directed character of surface expansion (whether extension is uniform in all directions).

Prior to presenting a quantitative treatment, selected patterns of local changes that can bring on changes in size or form in cells will be discussed qualitatively. The patterns are chosen on the basis of their simplicity, their pertinence to common cell shapes, and their relation to actual expansion patterns for which information is available. In Fig. 1, various figures of revolution are divided into zones to be followed through growth.

In part *I-A* of Fig. 1 a cylinder and a sphere are

broken up into zones which, when enlarged by the same factor and reassembled, give a new structure differing from the starting one only in size. In the case of the sphere, the zones are shown as sections of a right cylinder to facilitate judgment of changes in proportions. It is noteworthy that this is not the only pattern of local surface behavior that will enlarge the sphere. A sufficient approximation to spherical enlargement is achieved when there is a gradient in the rate of area increase of the zones (all zones do, however, retain their relative proportions) as seen in part *I-B* of Fig. 1. A pathway related to this is apparently employed by the enlarging sporangium of *Phycomyces* (see below).

In those situations in which proportions of the cell do shift, one can first distinguish between cases in which the entire surface of revolution is enlarging and those in which it is not. In the first category, *II-A* (Fig. 1), there is a special case (*II-A-1*) in which morphogenesis takes place in the absence of gradients in either the rate of area expansion of the zones or in the way that the zones shift their proportions during growth. All zones undergo the same sort of shift in proportions at the same rate. The morphogenesis is based only on the "gradient" in extension rate as a function of direction at each point on the surface. This pattern is characteristic of the cylindrical cells of *Hydrodictyon* and *Nitella* (1) and also certain higher plant organs, presumably including their constituent cells (2).

Where gradients are present, as in case *II-A-2* (Fig. 1), it is significant that the same change in form, from a right cylinder to a flaring one, can be brought on by two very different sorts of gradients. In case *a*, the proportions are preserved in all zones (isotropic expansion) but there is a gradient in the rate at which expansion takes place, the top growing fastest. The equivalent change in form (except for differences in roughness of outline due to the use of finite zones) can be seen in case *b*. Here there is no gradient in rate of area expansion but there is a gradient in the directed nature of expansion, increase in height predominating at the base. These two extreme pathways for the same morphogenesis would have to have quite different mechanisms physically. A gradient in rate of area expansion could have its explanation in local variation of *scalar* quantities such as wall thickness, amount of expansion inhibitor, or

stimulator, etc. When, however, the local expansion is directed in character (anisotropic) the potential explanation can be expected to involve some local *asymmetrical* feature of the cell such as a cytoplasmic texture, stress anisotropy, etc.

It is clearly seen here that information on cell outline alone (the flaring character) is not adequate to specify the local growth behavior that changes cell shape. The actual pathway in a cell could well involve gradients in both expansion rate and anisotropy. This could be realized only through the analysis of the behavior of marks on the growing surface which, in effect, delimit zones.

This same ambiguity—that a given change in shape can be potentially based on a diverse pattern of local growth activities—is also present in tip growing forms such as hyphae, root hairs, pollen tubes, etc., in which curvature is preserved in the growth zone as in part *II-B* in Fig. 1. Let us consider three such growing model cells in which the hourly increment in surface is a zone of the same height for each cell. We may assume that the cells grow indefinitely and that the curved growth zone must contain an unlimited number of such zones in various stages of enlargement. These "prospective" mature zones must be crowded densely at the tip where, for the sake of presenting a simple model, we assume they enlarge isotropically. There are few restrictions on the precise manner in which the zones approach the mature region. In case (*a*), the vertical component (along the profile or meridian) of the enlargement of the zone is predominant as the zone undergoes the apparent displacement to the base. This would distort a circle originally drawn on the surface near the tip into an ellipse with the long axis longitudinal. In case (*b*), the vertical and horizontal components change in similar proportion so that the circle remains undistorted as it enlarges. Finally, in case (*c*), the meridional component essentially ceases activity "early" in the development of a given zone and the transverse component acts to distort the circle primarily in the lateral direction. This potential diversity in the pattern of expansion of individual zones in the growing region could be involved in the general difficulty in relating wall texture to form in such cell types. Local cell detail—such as wall texture—is, therefore, not to be expected to relate to form *per se*, but to the local changes by which form is generated.

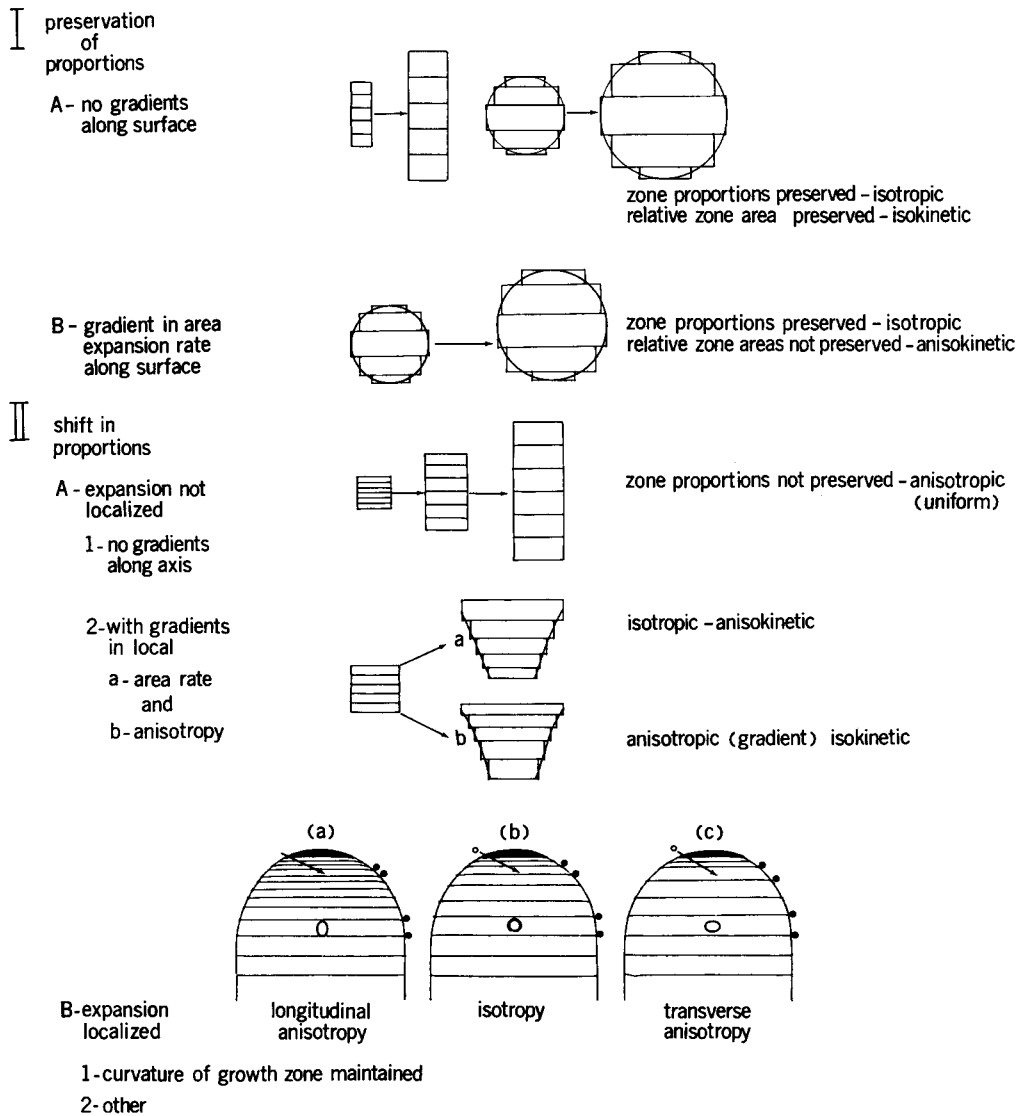

FIGURE 1 A diagram showing how the extension or change in cell form can be analyzed in terms of subdivisions of surface. The subdivisions are zones or bands and their changes in area and proportions can be readily followed. In case *I-A*, the cylindrical and spherical forms are extended by simple proportionate enlargement of all zones. Case *I-B* is of particular interest because here form is preserved despite disproportionate enlargement of zones. There is a gradient in expansion rate from top (fast) to bottom (slow). Case *II-A-1* is typical of many plant cells; all regions of the cylindrical surface show the same anisotropy of expansion. In case *II-A-2* a change in form is achieved by *a*, a gradient in the rate of enlargement, but no shift in proportions of zones; and *b*, a gradient in the direction of expansion of the zones, but not in the rate at which their surface increases. Part *II-B* illustrates that tip growing cells may show, at their base, surface behavior leading to (a) longitudinal distortion of surface, (b) isotropic expansion, or (c) transverse distention of surface. Case (b) is equivalent to Mercator's projection in cartography in which a spherical surface is converted to a flat (cylindrical) one with the minimum of distortion of local proportions.

QUANTITATIVE ANALYSIS OF SURFACE EXPANSION

The present paper is primarily concerned with the growth of zones of finite size over finite intervals of time. Methods giving information on zones of infinitesimal height at a given moment of time will also be mentioned, but these require especially smooth data and were not employed in this study. Adequate description of the zones requires their localization and their characterization.

Localization

Finite zones delimited by pairs of marks along the cell surface can be designated graphically either by their mean relative position along the cell axis or by their mean absolute distance from a reference point. When the latter method is used on tip growing cells, with the tip of the growth zone as the reference point, absolute distance from the tip is equivalent to relative position on the growth zone. In dealing with finite zones, mean "position" is actually a district on the graph axis. When zones of infinitesimal height are used, "position" of a zone is a point on the axis.

Localization with regard to time can be ignored if it is demonstrated that the behavior of zones is the same through time. In model systems this is usually explicitly assumed. In nature, the behavior of the growing surface must be examined over successive brief periods to see if this simplification is warranted. When it is not, separate graphs characterizing the expansion at successive times are necessary (see Fig. 40).

Characterization

1) **THE LINEAR COMPONENTS:** The expansion of a zone on a cell of radial symmetry is analyzed in terms of changes in two perpendicular linear components on the surface of the zone: one is along the circumference of the zone (the latitudinal or transverse direction), the other is perpendicular to it (the meridional or longitudinal direction). These directions are convenient for analysis because they are in the plane of the cell surface where the expansion actually takes place. This is also the plane of the cell wall texture, a factor significant in the control of plant morphogenesis. Values of the two components can be combined in various ways (presented below) to give the desired information on rate of area increase, shift in proportions (anisotropy), etc.

The change in one direction of a zone is measured by its relative rate of extension, r :

$$r = \frac{1}{x} \frac{dx}{dt} \quad (1)$$

where x is the dimension and t is time. This is a well known measure of linear change (3) and in practice is usually determined by the definite integral of the above expression.

$$r = \frac{1}{t_2 - t_1} \int_{t_1}^{t_2} \frac{1}{x} \frac{dx}{dt} dt = \frac{\ln x_2 - \ln x_1}{t_2 - t_1} \quad (2)$$

For example, a zone whose circumference increased from 1.2 to 2.4 mm during 1 hour would have a relative rate in this direction of 0.69/hour. This rate would be the mean one over the distance in question and during the time between length measurements. In model systems in which a rate pattern is applied to successive zones, the new dimension, after a period of growth, is found by multiplying the original one by a factor which is the anti-log_e of the relative rate for the time in question.

The relative rate of extension at a point and at an instant of time is the best characterization of extension (4). For an infinitesimal district, the relative elemental rate, r_e , is:

$$r_e = \frac{1}{dx} \frac{d(dx)}{dt} \quad (3)$$

This may also be expressed as:

$$r_e = \frac{d}{dx} \cdot \frac{dx}{dt} \quad (4)$$

which shows that the relative elemental rate at a point can be measured by determining the rate of change of velocity of the point (velocity being rate of departure from a fixed reference point) as a function of position. This method in practice involves the evaluation of two slopes: *a*) the relation of position to time to give velocity, and *b*) the rate of change of the velocity with position (4, 5). By treating the marks on the profile of a cell in pairs to give zones of length x and using Equation 2 or by treating them individually by Equation 4, one can characterize the extension of the vertical (meridional) component of surface expansion for various regions, or points, down the surface of the

cell. The circumferential component is readily measured by Equation 2 or 4 for single marks. The relative rate is the same for changes in radius, diameter, or circumference. The magnitude of the linear relative (elemental) rates in the two directions, as a function of position on the cell surface, constitutes the primary data for the characterization of the growth behavior of the zones.

2) CHARACTERIZATION OF THE SURFACE CHANGES OF ZONES

a) *Relative rate of area increase.* The relative rate of increase in area of a zone is the sum of the two linear components. If the area is $x \cdot y$, then the relative rate of increase in area is:

$$\begin{aligned} r_{area} &= \frac{1}{x \cdot y} \frac{d(x \cdot y)}{dt} = \frac{1}{x \cdot y} \frac{x dy + y dx}{dt} \\ &= \frac{1}{x} \frac{dx}{dt} + \frac{1}{y} \frac{dy}{dt} \end{aligned} \quad (5)$$

Adding the two components at various positions on the cell axis often reveals a gradient in the relative rate of area increase.

b) *Anisotropy of expansion.* The ratio of the two linear components, called the anisotropy ratio or allometric coefficient, is one measure of the directed character of expansion. When the ratio is 1.0, expansion is the same in all directions (isotropic). When the ratio is computed with the longitudinal (meridional) relative rate in the numerator, values greater than 1.0 reveal longitudinal anisotropy, the region showing a shift in proportions favoring length. Values less than 1.0 show a change favoring increase in circumference. The coefficient can be calculated directly from data on the relative rates of the two components. It may also be taken from the slope on a double-logarithmic plot of the dimensions of the height and circumference of zones (or, if growth does not vary with position, of the whole cells) at various stages of development. The basis for this test has been published several times (1, 2). A constant anisotropy ratio correlates well with a constancy of cell wall texture in *Nitella* and *Hydrodictyon* (1).

c) *Distortion during expansion.* The difference between the relative rates of the two components is a measure of the rate at which distortion of a circle drawn on the surface will take place. When the rates in the two directions are constant with time, the "axial ratio" a of a circle on the surface changes according to the equation:

$$\ln a = (r_1 - r_2)t \quad (6)$$

When the ratio is other than 1.0, this distortion parameter gives information on the rate at which distortion is taking place, information not contained in the anisotropy ratio. The equation is valid when one dimension is expanding and the other is contracting, as in the case of the surface of the cleavage furrow in sea urchin eggs.

The expansion of diverse model and natural cell surfaces will be quantitatively described in terms of the above parameters.

SPHERICAL SURFACES

PRESERVATION OF PROPORTIONS: On a spherical surface the lines of reference are meridional (pole to pole) and latitudinal. In a model system, one can impose a growth pattern (invariant with time) in which both meridional and latitudinal rates are equal to each other and invariant from pole to pole. Such a pattern is called isotropic and isokinetic and it serves to enlarge the sphere (Fig. 1). This pattern for the expansion of a sphere is to be expected in free-living round cells such as *Chlorella*.

A rate pattern with a linear gradient in both the meridional and latitudinal relative (elemental) rates (anisokinetic growth) also serves to enlarge a spherical surface (Fig. 2). A zone follows the rate specific for its relative position on the meridian. The relative position of a material zone will shift with time in this model. The rates are equal to each other at all points, so growth is isotropic. When the extension rates drop to zero at the base, the model is particularly appropriate for the expansion of a sphere from a fixed point of attachment. Such a structure is the enlarging sporangium of *Phycomyces*, and some information on the behavior of zones could be obtained from photographs taken by Castle (6), enlarged here from the original negative (Fig. 3). Note that the separation of the marks at the top is proportionately much greater than the separation of the lower pair of marks. Measurements of changes in diameter cannot be used in calculating the rate pattern here because the relative position of a zone shifts downward with time. Without marks present, one does not know the initial position of the diameter as measured at the end of growth. The rate pattern employed by the sporangium, as calculated from the photographs, is given in Fig. 2 and roughly approximates that of the model. A

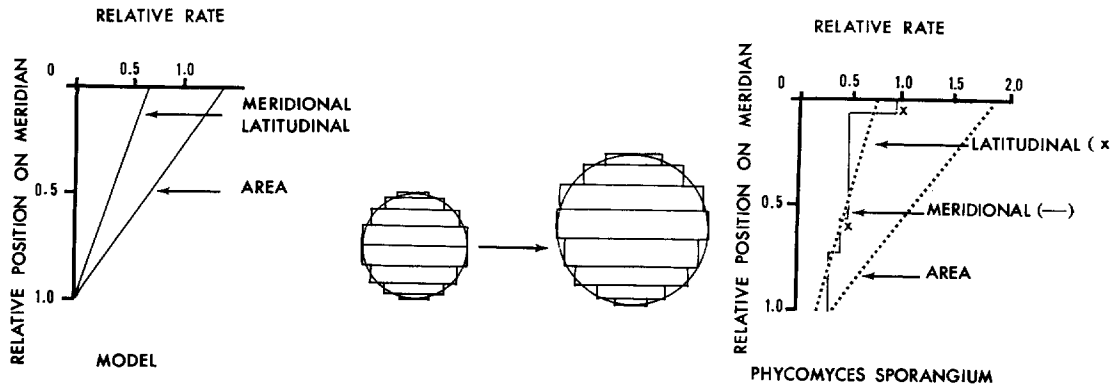

FIGURE 2 At left is the quantitative rate pattern used in the enlargement of the sphere diagrammed in the center. Each dimension of each zone was multiplied by the anti-log_e of the relative rate corresponding to the relative position of the zone. Note the steep gradient in rate of area expansion that still tends to preserve spherical form. At right are data calculated from Castle (see Fig. 3) and similarly plotted. There appears to be a gradient in both meridional and latitudinal rates, as shown by the dotted line. Some similarity to the model is apparent.

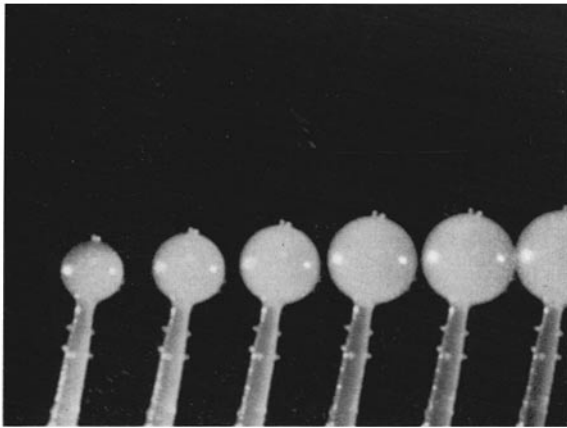

FIGURE 3 Time-lapse photographs of an enlarging sporangium of *Phycomyces* greatly enlarged from a negative used in a publication of Castle (6).^{*} The greater relative separation of the two marks at the top of the sporangium, compared to the two marks at lower right, reveals a gradient in the rate of surface expansion. Interval 30 minutes. This gradient is shown quantitatively in Fig. 2. $\times 27$.

^{*} (Reproduction by permission of author and publisher from *Am. J. Bot.*, 1942, 29, 664.)

gradient in wall thickness (thin at the top) or in expansion-controlling hormones might be expected in the sporangium. There is a wide variety of more complex patterns containing gradients in expansion rate and anisotropy which would also preserve the form of an enlarging sphere; many other patterns would not.

The most dramatic distortion of spherical surface is probably that characteristic of animal egg cleavage. Excellent data by Hiramoto (7) permit the calculation of the rate pattern for half of the egg as shown in Fig. 4. The pattern shown is the over-all one for first cleavage, based on the typical displacement of marks (delimiting zones) on the surface of the egg. There is a gradient in rate of area expansion (and contraction), but the

most striking feature is seen in the furrow where the meridional component extends while the latitudinal component is contracting. The distortion (difference between the relative rates in the two directions) is extreme. A circle originally drawn in the prospective furrow region would become roughly 3 times longer in the meridional direction, and shrink to $\frac{1}{3}$ its original diameter in the latitudinal direction, giving a final axial ratio of about 9:1. This calculation is approximate because there were relatively few marks in the furrow.

CYLINDRICAL CELLS

RIGHT CYLINDERS: As mentioned in the Introduction, many cylindrical cells which grow all along their surface can show a shift in pro-

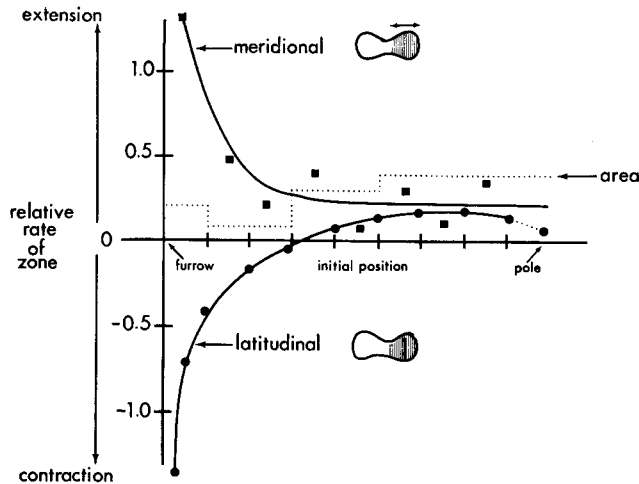

FIGURE 4 A plot of the distortions on half of the surface of the dividing sea urchin egg, calculated from data of Hiramoto (7). The meridional component is the linear component in the plane including the axis of rotation of the figure; the latitudinal component is at right angles to this. The rates are the mean ones over the first cleavage and are plotted as a function of initial position. The relative rate of area increase is the sum of the two linear rates and shows less variation with position than the individual components. Duration of cleavage, 7 minutes (Hiramoto, personal communication).

portions even though there is no gradient in either area rate or anisotropy along the cell surface. Expansion at all points on the cylindrical surface is anisotropic to the same extent. The anisotropy ratio for the primary *Nitella* shoot internodes has been shown to be about 4.5, over several orders of magnitude in cell size (1). Inspection of the intact *Nitella* plant reveals that the internodes of the laterals of limited growth (secondary internodes or leaves) tend to be relatively longer in their proportions than those of the shoot. Still smaller laterals of limited growth (tertiary internodes or leaflets) are even more elongated in their proportions (Fig. 5). In other words, at a given cell length the shoot internodes have the greatest diameter, the leaflets the least. This could be brought about by *a*) the existence of anisotropy ratios of increasing magnitude for the internodes of the shoot, leaf, and leaflet; or *b*) the existence of the same anisotropy ratio for all, but with the initial cell proportions different. The plot in Fig. 5 indicates that the latter possibility is correct. The establishment and maintenance of an anisotropy ratio of about 4.5 is thus a fundamental activity of the cylindrical surfaces of the plant.

The structural basis for this anisotropy of expansion appears to be the transverse arrangement of fibrillar components in the cell wall (8-10). This arrangement is believed to hinder increase in girth and permit increase in length. Physical measurements supporting this view for *Nitella* have been made by Probine and Preston (11). This wall texture is, in turn, due to a directed synthesis of wall materials by a cytoplasmic skeleton (12). Because the orientation of synthesis is sensitive to

colchicine, it was suggested that proteins of spindle fiber character were active in the ultimate control of cell form (13). The microtubules found oriented transversely in the cortex of many plant cells (14, 15) may be elements in the cytoskeleton. Their spindle fiber character is appropriate and their band-like disposition could explain a peculiar insensitivity to the direction of maximum strain noted for the synthesis of wall materials in *Nitella* (12). Microtubules, oriented "not parallel to the streaming axis" (roughly transversely?), have been seen in electron micrographs of *Nitella* internodes (Dr. R. Nagai, Princeton University, unpublished). Anastomosing structures, apparently tubular in character and associated with wall deposition, have been shown in *Nitella* and its relatives (16, 17). Their configuration was not studied in relation to the adjacent wall structure.

FLARING CYLINDERS: A right cylinder may be transformed into a flaring one by the application of gradients in the meridional and latitudinal components. If the two gradients are identical and linear, there is a gradient in area rate in the cylinder but expansion is isotropic at all points. It is interesting that putting the same gradients in anti-parallel fashion, where there is no gradient in area rate but rather a gradient in anisotropy, brings about a comparable change in form. Thus, in this pair of extreme cases, change in form—and its rate—can be independent of the way gradients in the two components are imposed (Fig. 6). The same change in form could, of course, be brought on by any number of patterns in which gradients in both area expansion rate and anisotropy are present. In such mixed cases the

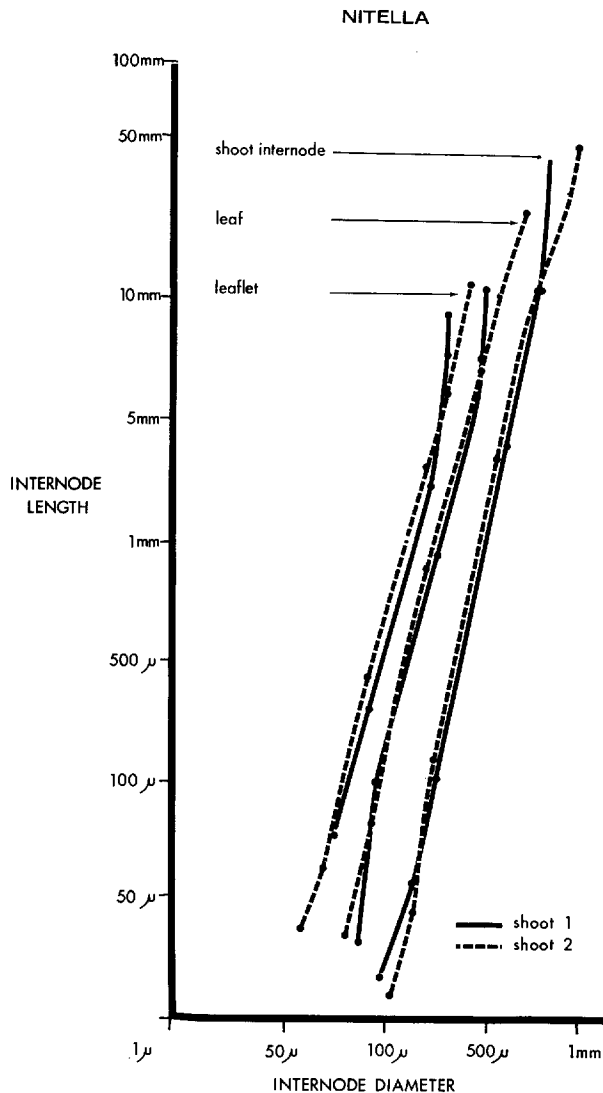

FIGURE 5 A double logarithmic plot of length versus diameter for primary (shoot), secondary (leaf), and tertiary (leaflet) internodes in *Nitella*. The similarity in slope indicates that all three structures have the same anisotropy ratio (allometric coefficient) of expansion. The differences in proportions at a given length appear to result from differences in the proportions of the starting structure, its being most elongate in the leaflet.

extent to which the area rate alone is responsible for the change in form can be determined by following, on paper, a rate pattern based on the mean values of the two perpendicular components. Discrepancies between the changes brought on in the model and those seen in the cell would then be due to the anisotropic aspects of the cell's rate pattern.

EXPANSION OF HEMISPHERICAL GROWTH ZONES

As noted in the Introduction, it is possible for curved cellular growth zones of identical size, curvature, and growth rate to have different expansion patterns on their surface. As a given

zone undergoes its apparent migration down the growing region, the latitudinal component will generally show a decreasing relative rate as the mature region is approached because most of the potential increase in diameter has occurred. This rate, while "slow," is none the less finite, and, therefore, the meridional component can exceed it, equal it, or be less than it.

The condition for keeping the two components equal to each other—thus for maintaining isotropic expansion on the curved growth zone—has been pointed out to the author by Dr. Zygmunt Hejnowicz of the University of Wroclaw, Poland. The relative elemental rate of expansion along the

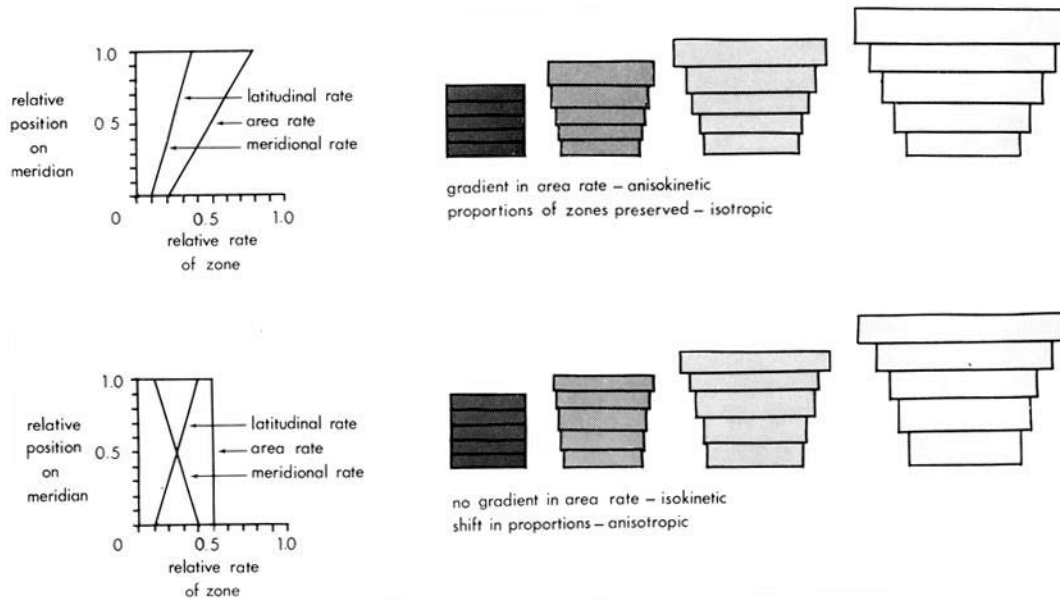

FIGURE 6 The production of a flaring cylinder from a right cylinder by two different rate patterns. In the upper pattern, the linear extension rates for both the vertical (meridional) and horizontal (latitudinal) components lie on a linear gradient. Because these rates are equal to each other at all points, expansion is isotropic. There is a strong gradient in area rate. Below, the same morphogenetic change is brought on, but now with the gradients in the two components being antiparallel. There is no gradient in area rate, but a strong gradient in anisotropy with transverse anisotropy at the top of the figure and longitudinal at the base.

meridian must be equal to the rate of change of velocity—as a function of position—of a point “moving down” the meridian. To give isotropy, this rate of change of velocity must be adjusted to match the fractional rate of change of circumference of radius at the point. This is achieved when the velocity of the point, as a function of distance down the meridian, m , varies in proportion to the distance from the axis, r (at the point), as the point moves down the meridian. This special condition is diagrammed in Fig. 7. It can be shown that when dm/dt is proportional to r raised to a power less than one, latitudinal anisotropy is the result; when dm/dt is proportional to r raised to a power greater than one, longitudinal (meridional) anisotropy results (18).

Because longitudinal anisotropy is so remarkably characteristic of the development of the *Nitella* shoot, it was thought probable that the basal part of the apical cell, which gives rise to internodes by the sequence depicted in Fig. 8, would show it. Shoots were dissected to expose the apical cell and held in clamps (Fig. 9) to permit time-lapse photography with 16-mm equipment from Cooke,

Troughton, and Simms Ltd., York, England, and from Zieler Instrument Co., Boston. For the delimitation of zones, various particulate substances were used. Graphite and cerium oxide powders gave good contrast but did not stick well to the expanding surface. Ground Amberlite anion exchange resin (No. 400, Rohm and Haas, Inc., Philadelphia) was stable and stuck well, but did not present the ideal spherical outline. Small anion exchange resin spheres, made to order by Microspheres, Inc., Palo Alto, California, were the best and were applied with a De Fonbrune micromanipulator. Photographs were taken in a large aquarium (Fig. 10) at one exposure every 4 minutes.

SHOOT APICAL GELL: It was found in lenticular apical cells that both the meridional and latitudinal relative rates for the various zones of the apical cell tended to decrease continuously from the tip of the cell toward the base (Fig. 11). This shows a strong gradient in rate of area expansion, the maximum being at the tip as in the sporangiophore (19) and the sporangium of *Phycomyces* (Fig. 2). A less obvious feature of the

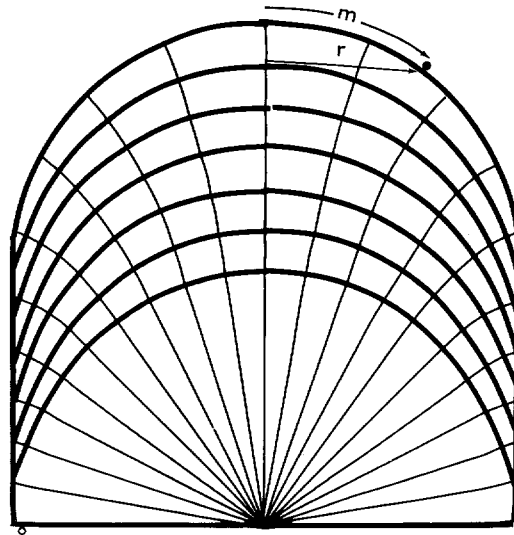

ISOTROPIC GROWTH

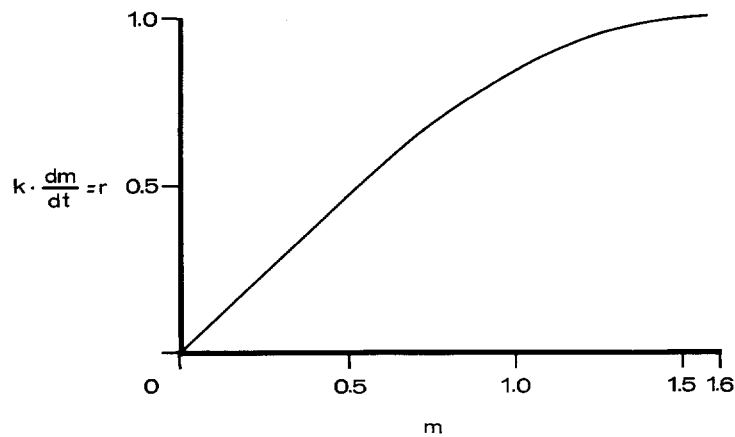

FIGURE 7 A diagram illustrating the special conditions giving isotropic expansion of surface in tip growth (hemispherical). The relative rate of linear extension in the latitudinal direction (r) is a function of the velocity at which the point moves down the meridian. The meridional relative elemental rate is a function of the rate of change of velocity at which the point moves down (Equation 4). When the velocity (dm/dt) varies with position in the same way as does r , then the fractional change in r will be the same as the fractional change in velocity, and the special condition of equal relative elemental rates in the two directions will be met. The diagram shows the growth zone at various equally spaced intervals of time. Note how points initially equally spaced on the meridian undergo relative displacement downwards. The trajectories of these points show orthogonal intersection with the surface.

rate pattern is the indication that, in the early stages at least, the latitudinal component is greater than the meridional. This effect appears only at the base of the cell where rate data are relatively accurate for the latitudinal component (diameter

is great), relatively inaccurate for the meridional component (the zone is not high). For this reason, photographs showing this effect are provided. Note that in Figs. 12 to 16 the meridional component, as seen in the zone between marks c to d ,

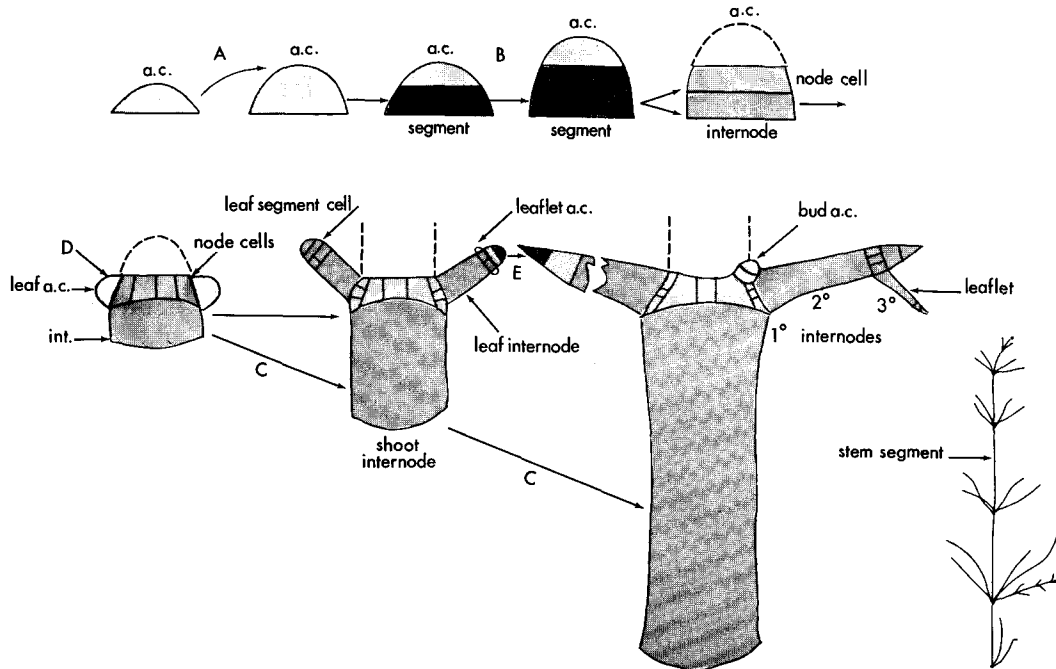

FIGURE 8 A diagram of shoot development in *Nitella*. The apical cell (a.c.) alternately expands and divides to produce the transitory segment cell. This cell, after expansion, divides to form an upper node cell and a lower internode cell. The latter expands enormously without further division except of its nuclei. The node cell divides up into a plate of cells; the peripheral cells become leaf apical cells which behave generally in the manner of shoot apical cells, except that only a few segment cells are produced and the leaf apical cell undergoes a final rapid change in form from the hemispherical to the conical. The lettered cell expansions, A to E, receive detailed consideration in the text.

shows virtually no activity while the corresponding latitudinal components, the diameters at the marks, increase appreciably (25 and 36 per cent). In the sequence Figs. 22 to 28 this transverse stretching is seen to straighten the optical section of an initially curved cross-wall. Further documentation is found in Figs. 29 to 34 in which the region *a-b* hardly changes in length while diameters at these points increase about 14 and 23 per cent, respectively. On the basis of these figures, it is concluded that there is a predominant transverse anisotropy of expansion at the base of the apical cell, this being the first asymmetrical expansion in the ontogeny of a given district of surface. Its transverse character is surprising in light of the fact that the next later stage in development, the segment cell, clearly shows longitudinal anisotropy of expansion as in Figs. 12 to 14, in which the meridional component increases about 45 per cent while the diameters at the ends of the cell increase only 15 and 10 per cent. This

cell shows both the surface behavior and the wall texture (transverse microfibrils) of the internode to which it gives rise (Fig. 21). That this transition can perhaps take place precociously is indicated in Figs. 17 to 20 in which the apical cell grew exceptionally large. The distortion at the cell base was essentially isotropic (Fig. 11, roll 12). The increase in distance *g* to *h* in Figs. 22 to 24 even suggests elongation in the base of a large apical cell.

THE LEAF APICAL CELL: This cell shows somewhat similar behavior. During the stages when it is producing leaf segment cells, the meridional component on parts of the curved surface is essentially zero. In Figs. 29 to 34 the marks *h* to *i* fail to separate despite great increases in diameter at their positions. The entire base of the cell appears to be quiescent for a period, as both the mark separation *j* to *k* and the diameter *g* to *k* are constant through Figs. 29 to 31. Later on, such regions elongate. Other sequences show

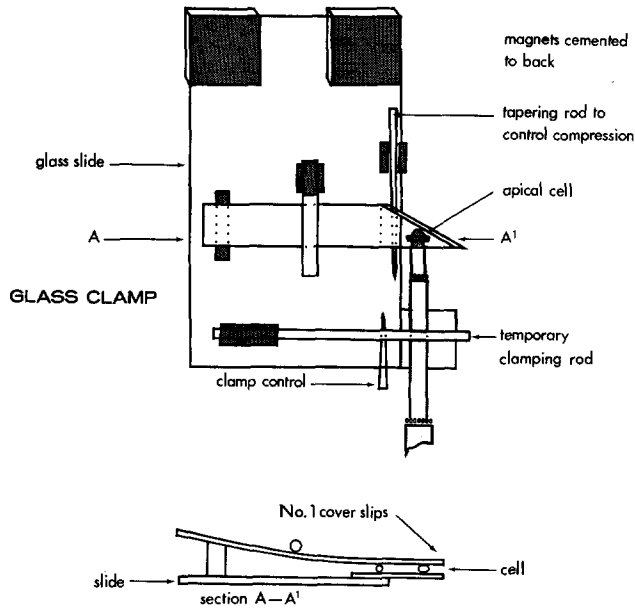

FIGURE 9 The clamp used for both dissection and holding the plant during growth for time-lapse photography. For dissection and marking, the tip of the plant projected from the triangular jaws of the clamp. Light compression by the temporary clamping rod held the plant in place while it was rotated and shifted during preparation. Cross-walls in the apical region are clearly seen only from certain directions. Until the plant tip was compressed for photography between the triangular jaws, it was held in such a favorable position by the temporary rod. Once the clamp was in the aquarium, the temporary rod was broken off to permit elongation and rotation of the internodes below. Otherwise, the twisting would occasionally stragulate the cells.

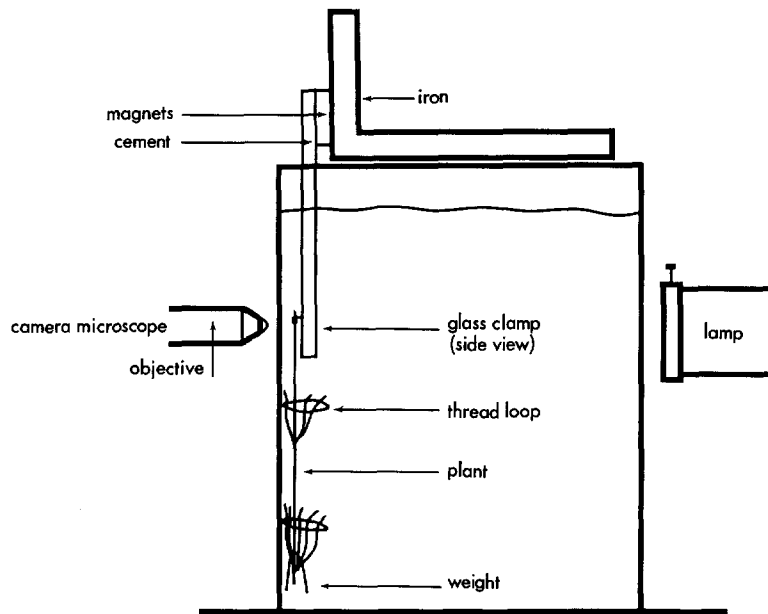

FIGURE 10 Arrangement for time-lapse photography. The apical region of the plant was clamped in a suspended glass device. The plant was caused to hang down vertically by the addition of a small weight at the base, so that it could rotate as the internodes elongated and twisted. Loops tied around the leaves facilitated this rotation.

that a given zone delimited by four marks will undergo a clear lateral distention while in the apical cell, and then will elongate manifold after it has become part of a segment cell.

The most striking morphogenetic event exclusive to the leaf apical cell is its final growth into a cone. This is done rapidly (Figs. 33-39) and with very marked activity in the meridional com-

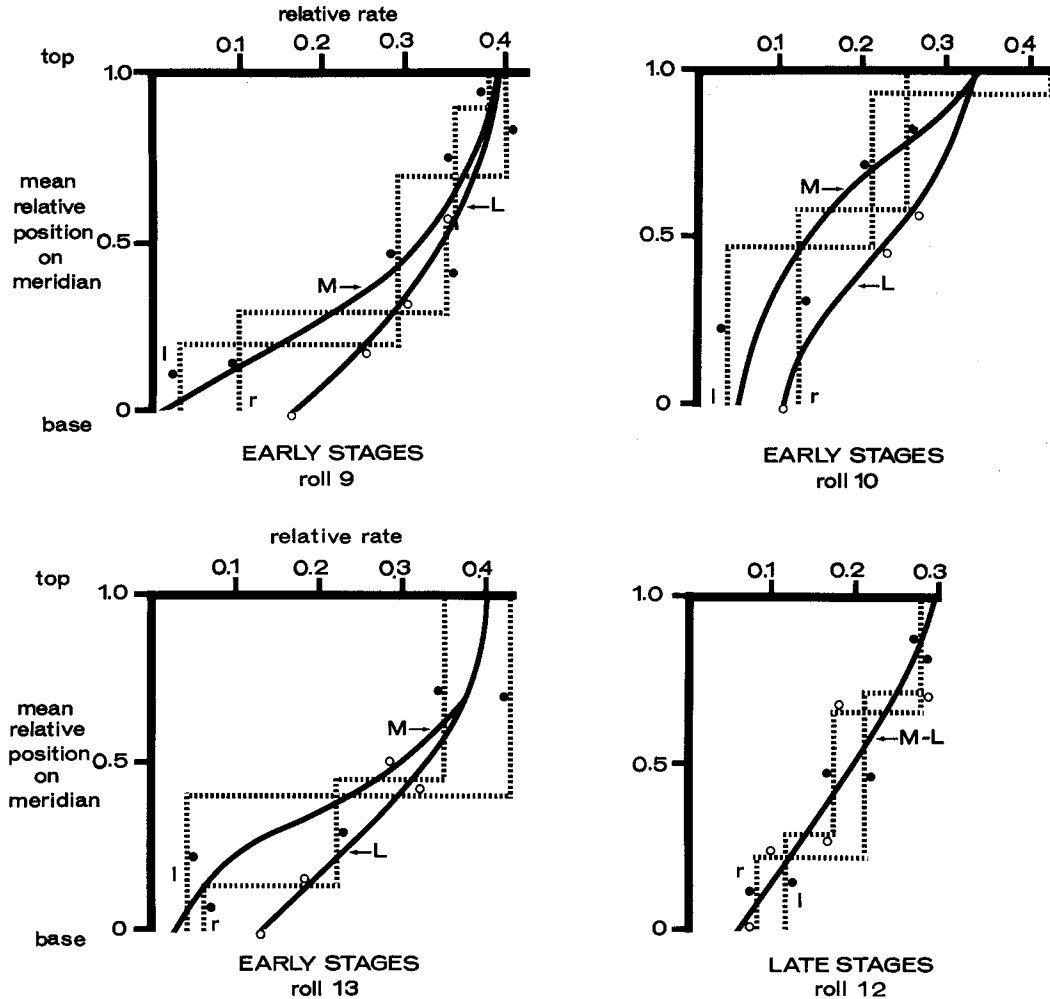

FIGURE 11 Rate patterns for four shoot apical cells. The meridional (M) component is calculated from the separation of pairs of marks on the profile of growing cells as in Figs. 12 to 20. This component has been calculated for the left (l) and right (r) sides of the cell. The rate is the mean one for the zone, and hence the plot for each side is a bar graph shown as a broken line. A solid dot is placed at the mid-point of each bar, and a line has been drawn through these by eye. The latitudinal (L) component is calculated for single marks and is shown by the open circles, these being connected by a solid line. Early stages are those in which the ratio of cell height to basal diameter is in the range 0.26 to 0.40. In late stages, the ratio is 0.36 to 0.55. (Roll 9 corresponds to Figs. 29 to 34, roll 10 to an unpublished sequence, roll 12 to Figs. 17 to 20, and roll 13 to Figs. 12 to 20.) All graphs show a gradient in rate of both components from the top of the cell (high) to the base (low). In the early stages, there is an indication that the latitudinal component predominates at the cell base.

ponent! In fact, the longitudinal anisotropy of expansion is comparable to that seen in internodes (ratio 4.5). A recent time-lapse sequence (18) of earlier stages has shown that basal zones first undergo isotropic expansion, then a lateral distention, and finally shift rapidly to the longi-

tudinal anisotropy. Zones near the tip, however, pass directly from isotropic to longitudinal anisotropy. It thus appears that a transitory period of transverse stretching is generally a prelude to local elongation in cylindrical cells but not in all parts of conical cells.

DISCUSSION

At least 95 per cent of the surface of the *Nitella* shoot is cylindrical. Each such surface is derived ultimately from a region of an apical cell of a shoot, leaf, or leaflet (Fig. 8). A given zone on the surface near the tip of an apical cell undergoes an essentially isotropic expansion, while later, when near the base, it undergoes a predominantly lateral or transverse expansion. About the time this basal region is cut off into a segment cell, expansion becomes predominantly longitudinal with an anisotropy ratio of about 2.5. The basal part of the segment cell is delimited, by cell division, into an internode which elongates enormously with an expansion anisotropy ratio which has risen to about 4.5. This pattern is typical for both shoot and leaf development, except that the final morphogenetic expression of the leaf apical cell is the rapid attainment of the conical form through local elongation (longitudinal anisotropy of expansion), which does not happen in shoot apical cells.

This sequence of local surface behavior can be discussed in terms of its physical basis and its possible developmental role.

The Possible Physical Basis of the Distortion Pattern in the Apical Cell

In the case of the internode it was possible to account for the directed character of growth by the anisotropy of wall texture. In the apical cell

much of the cell wall texture is apparently random—at least in small samples seen in the electron microscope (24). The distortion pattern of the apical cell—rapid and isotropic at the tip and generally slow and with transverse anisotropy at the base—can be imitated in a model membrane system. If a circular rubber membrane is constrained at its rim and then caused to bulge by pressure, it will expand most rapidly in the center and will expand isotropically in all regions. If, however, the membrane is artificially thickened near its margin, this marginal or basal region will show transverse anisotropy—again with expansion at a slow rate. The reason for this appears to be that the allometric coefficient, K , for the basal region is a function of the rate of departure, dm/dt , of this region from the tip of the bulge.

$$K = \frac{\frac{d}{dm} \cdot \frac{dm}{dt}}{\frac{1}{r} \cdot \frac{dr}{dt}} = \frac{\frac{d}{dm} \cdot \frac{dm}{dt}}{\frac{1}{r} \cdot \frac{dr}{dm} \cdot \frac{dm}{dt}} \quad (7)$$

Over small changes in the shape of the bulging membrane or in the relatively constant curvature of the apical cell, r and dr/dm do not change much. The rate of departure, dm/dt , of a point near the base will only be slightly less than in the unreinforced membrane. The rate of change of this velocity, however, which is equal to the numerator of the fraction in Equation (7) will be very small because of the local inextensibility due

FIGURES 12 to 20, 22 to 34 Points of reference, either points of attachment of spheres or intersections of cell walls, are numbered alphabetically. *a.c.*, apical cell; *s.*, segment cell; *n.*, node cell; *i.*, internode cell. Hours of growth are shown.

FIGURES 12 to 16 This sequence illustrates the extremely slow rate of separation, along the meridian, of marks which lie at the base of the apical cell. Note that marks *c* and *d* separate only very slightly, at most about 10 per cent over-all and essentially zero from 6 to 24 hours, while the diameter of the base of the cell, the line *c* to *g*, increases somewhat more than 25 per cent. This shows a predominant transverse anisotropy of expansion for this region. This sequence also shows the rapid growth of the segment cell during the period 0 to 12 hours. Expansion is mostly at the top of the cell because an upper zone delimited by *b-c-g-i* enlarges much more than the lower one *a-b-i-j*. The transverse component of this rapid expansion may tend to distend the apical cell transversely. Data from these figures are in Fig. 11. $\times 500$.

FIGURES 17 to 20 A sequence showing the late stages of apical cell enlargement. The zone delimited by *a-b-e-f* increases approximately isotropically although the distance *e-f* is nearly constant. The enlargement of the upper cone-section *b-c-d-e* takes place essentially isotropically and at a relative rate much greater than that of the basal region. Data from these figures are in Fig. 11. $\times 670$.

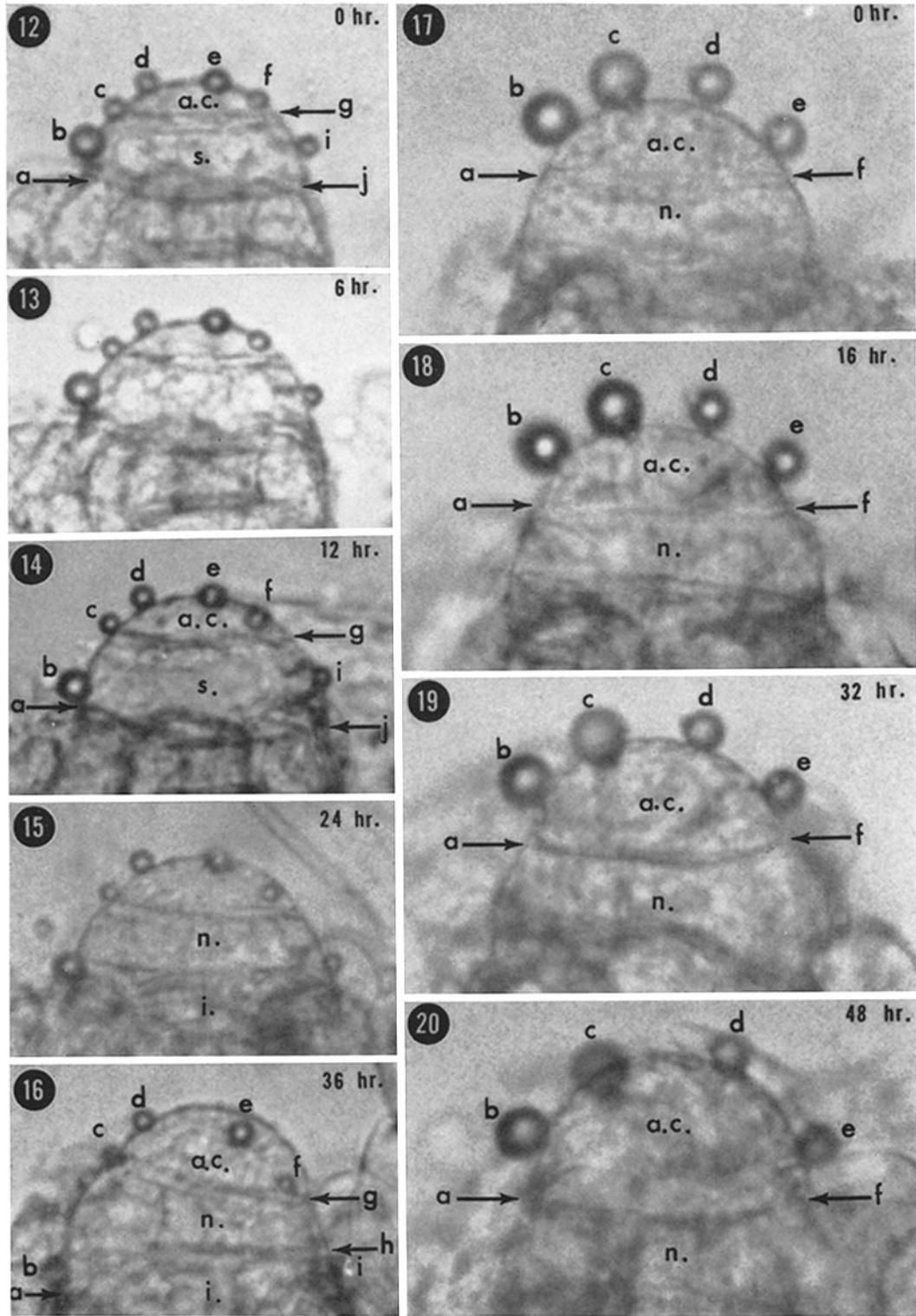



FIGURE 21 A triple exposure of living apical and segment cells taken between polarizing prisms. The crossed prisms were rotated 30° between exposures. The appearance of two minima in intensity in the segment cell is thus due to weak retardation in those regions, not due to coincidence of the axes of the wall birefringence with the directions of transmission of the prisms. These minima indicate that the wall is biaxial in a manner characteristic of a scattered but predominantly transverse arrangement of cellular microfibrils (9, 12). $\times 420$.

to reinforcement. This will lower K to a value less than 1.0 (18). It is possible that the basal cross-wall of the apical cell in the shoot serves as a partially constraining structure and that for some reason the basal region of the apical cell wall is less extensible than the tip. Constraint is only partial because the basal diameter of an apical cell slowly increases. This increase could also contribute to the transverse anisotropy. Thus the transverse distention of the lenticular apical cell could also be, in part, based on the relatively rapid increase in the diameter of the segment cell with which it is in physical continuity. The base of the leaf apical cell shows very little enlargement, so the transverse expansion observed here (18) presumably has its physical basis solely in a gradient of extensibility which causes a low value for K in Equation (7). The transition in distortion pattern from transverse to longitudinal, which in the shoot normally involves both the apical and segment cells, can take place entirely within the leaf apical cell because of the characteristic elongation (Figs. 35 to 39) seen at the end of leaf apical cell development. Some records on the shoot indicate that, if the apical cell becomes very large before dividing, and its base is

nearly cylindrical, this basal region behaves kinetically like a segment cell, showing longitudinal anisotropy of expansion. These observations indicate that whatever the physical basis for this change in direction of expansion is, its essential elements can be found within a single cell.

A Possible Developmental Role for the Apical Cell Distortion Pattern

There are precedents in the literature for considering oriented strain to have a role in development. The aligning action of strain on plant material has been shown in "multi-net growth" in which cellulose microfibrils near the outer surface of the wall are passively aligned into the direction of maximum extension (20). If the present transverse anisotropy of expansion is general for tip growth, it could explain the concentric arrangement of microfibrils seen on the outer surface of hypha tips by Strunk (21). Orienting effects of strain on the cytoplasm have been demonstrated in *Nitella* in which the character of chloroplast growth is highly dependent on the direction and magnitude of the strain pattern in the adjacent cell wall (22). A potential orienting role for strain has been shown in the sea urchin egg in which artificially stretched eggs generally cleave in the plane normal to the direction of stretch (23).

The transverse stretching observed here in the development of lenticular apical cells may be instrumental in the initial alignment of microtubules into the transverse direction in which they typically remain during cylindrical elongation. This assumes that microtubules are present at random in the plane of the cortex of the tip of the apical cell. Microfibrils have been seen in this configuration in the apical cell (24). The observed strain would probably not be sufficient to bring the microtubules into the highly aligned pattern seen in elongating cylindrical cells (of higher plants). One would have to assume that the strain alignment served mainly to "seed" the spontaneous aggregation of these long elements into a parallel transverse array. Once so oriented, these structures could be associated with the synthesis of transversely oriented cellulose. Progressive improvement in this microtubular alignment—and related wall textures—may account for the increase in anisotropy ratio of expansion noted in the developmental sequence: base of apical cell, segment cell, internode. Because new mass is added pri-

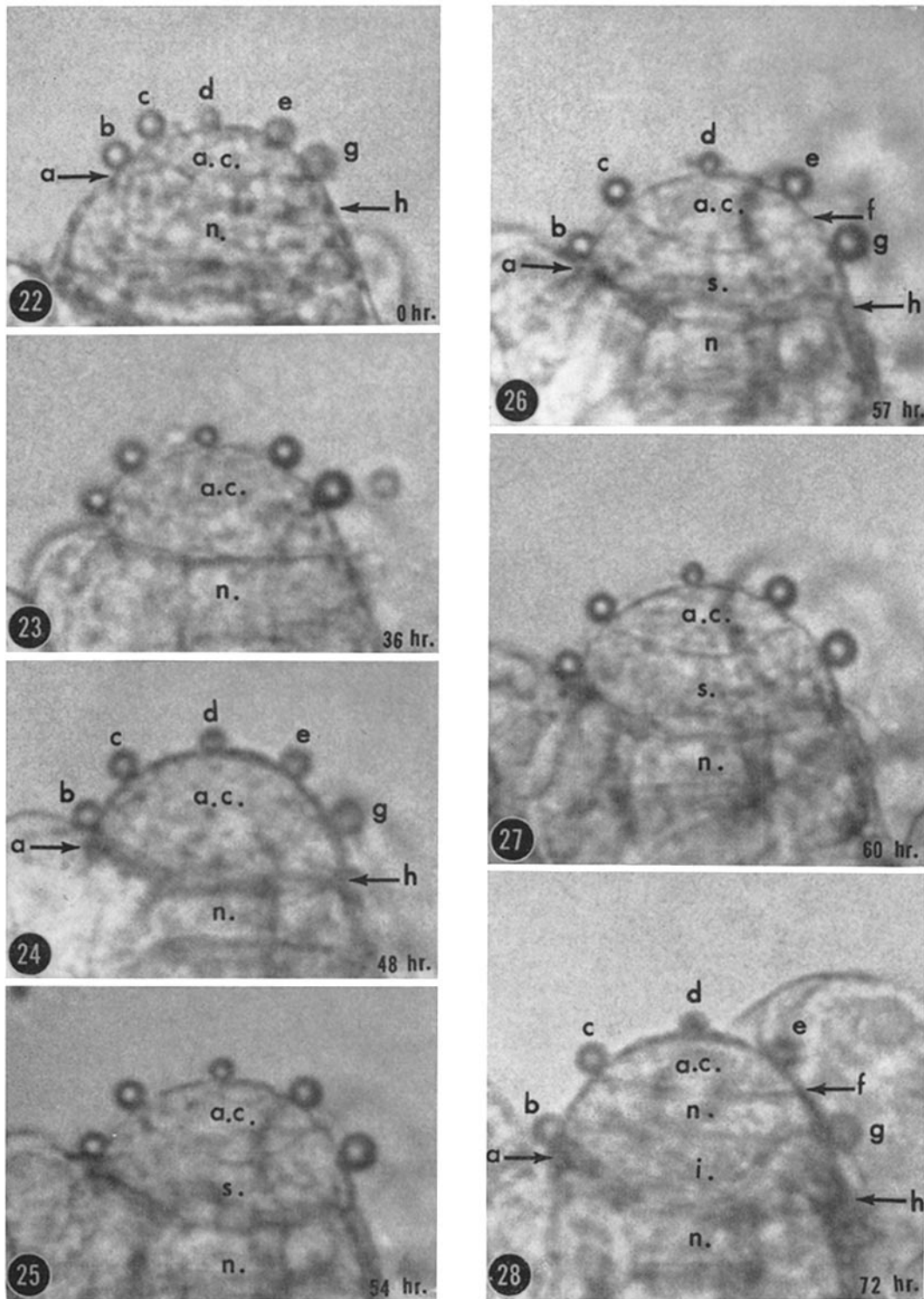

FIGURES 22 to 28 Abbreviations as in Figs. 12 to 20. The formation of the cross-wall in the shoot apical cell. Note that the cross-wall is flattened essentially by stretching, because its optical section does not increase appreciably in length during the period 54 to 72 hours. The remarkable stability in the relative position of mark *d* indicates that the expansion is symmetrical about the geometrical tip of the cell. This is in contrast to the conclusion of Soma and Ball (32) for the multicellular apex of higher plants. $\times 600$.

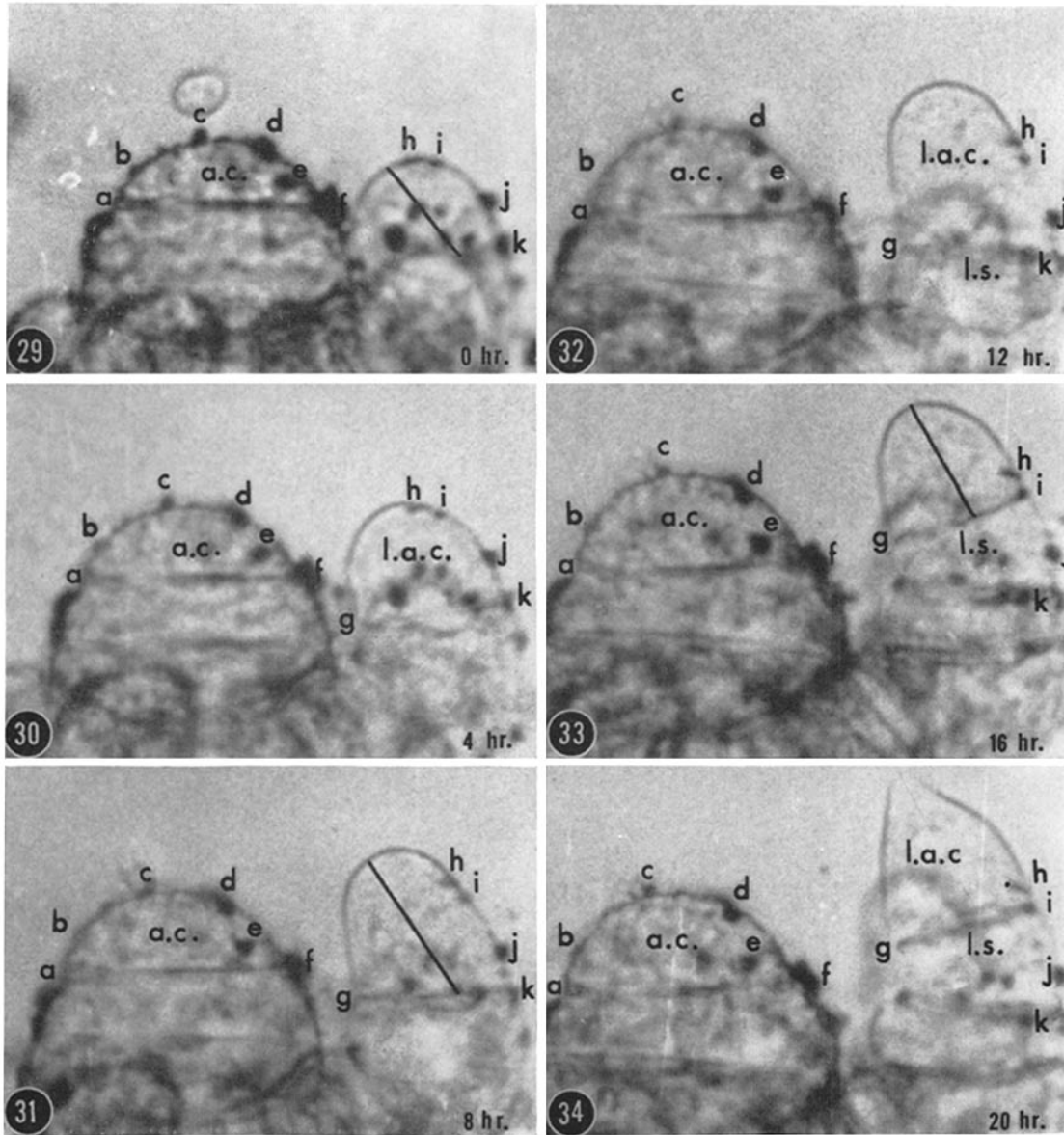

FIGURES 29 to 34 Behavior of the leaf apical cell (*l.a.c.*) during segment cell (*l.s.*) production. Note that the three marks *h-i-j* fail to separate as the cell enlarges, despite considerable increase in diameter in their vicinity. This indicates predominant transverse anisotropy in the region. Growth is not symmetrical about the geometrical tip of the cell in Fig. 29, the axis (oblique line) changing due to rapid growth at the left. Marks are graphite. Note also that on the adjacent shoot apical cell (*a.c.*) the distances *a-b* and *e* to the line *a-f* remain essentially constant as the cell enlarges. This reveals transverse anisotropy at the cell base. $\times 600$.

marily at the wall inner surface, any improvement in the transverse character of wall synthesis would show its full effect on the longitudinal anisotropy of expansion only after most of the preexisting wall

had been diluted out by increase in cell area. The present notion that strain effects are active in establishing cytoplasmic organization receives partial support in the fact that a new axis of

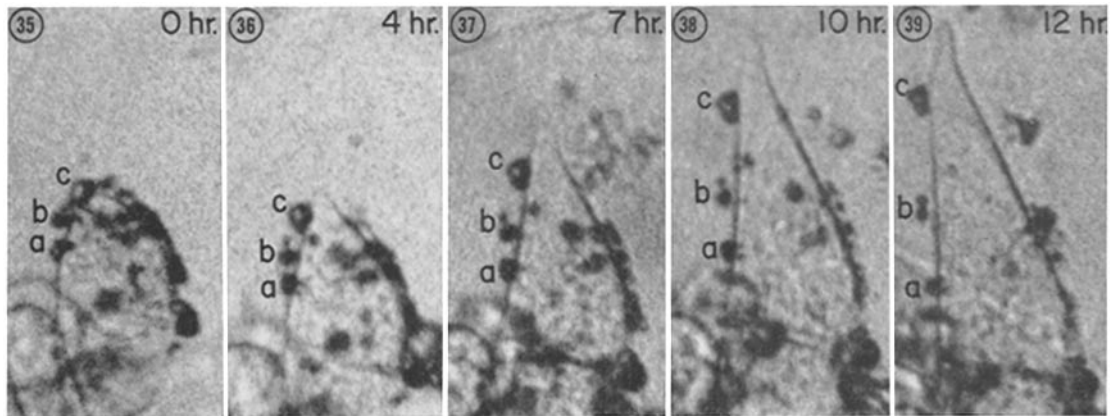

FIGURES 35 to 39 The rapid attainment of the conical form by the leaf apical cell, as presented graphically in Fig. 40. The separation of marks *a*, *b*, and *c*, while diameters at these points remain nearly constant, shows highly anisotropic elongation (longitudinal component predominating) which is not typical of these or other apical cells when they produce segment cells. $\times 660$.

growth (with appropriate wall texture) can be induced in internodes by mechanical means involving constraint at the margin of growing surface (1). When a young cell is jacketed in perforated dialysis tubing, a lateral cylindrical protrusion—with wall texture transverse to its own axis—occasionally grows out. The detailed strain pattern in this induction was unfortunately not determined. Contrary to our assumption at the time, the initial strain pattern may have had a predominantly transverse character.

The present model envisions an interaction between strain alignment and crystallization processes as instrumental in the establishment and maintenance of transverse wall texture in *Nitella*. A model based exclusively on crystallization patterns has been proposed by Preston (25) to account for the “crossed-fibrillar” wall textures found in many other algae. In brief, layers of spherical granules in cubic close-packing add new residues to growing microfibrillar cellulose. Because microfibrils tend to be stiff, they could grow through such arrays only in orthogonal or diagonal directions, the particular directions found in a given species being a function of the internal structure of the granules. The model has support from the granular appearance of cytoplasm adhering to wall inner surfaces in the alga *Chaetomorpha* and from apparent fibril-synthesizing particles seen in frozen-etched preparations of the cell membrane of yeast (26), where, however, the crossed fibrillar texture is not found. The model

accounts for the observation that only a few directions of synthesis are found in many walls, but does not concern itself with the mechanism establishing the species-specific relation between the cell axis and the directions of synthesis. The distortion pattern of cell surface which generates cell form in these species has not been worked out quantitatively, and thus both its origin and its effects on the peripheral cytoplasm have received little consideration.

A third orienting process, electrophoresis, is of potential consideration because macromolecules can respond to applied fields (27), and distortions of cell walls can produce directed fields by piezoelectric mechanisms (28).

It is concluded that form is to be explained by the rate and directed character of distortions of cell surface that generate it, and that both scalar and oriented features of the cytoplasm must be active in most cellular morphogenesis.

Historical Note

The division of the apical cell of *Chara* was used by Hofmeister (29) as a detailed illustration of his “rule” that cross-walls tend to form in a plane perpendicular to the direction of previous maximum growth. Curiously, his account states that volume of the apical cell increases in the direction of all radii which start from the mid-point of the concave basal wall and that the new cross-wall appears at right angles to these radii, being “concave upward.” To lie at right angles to such

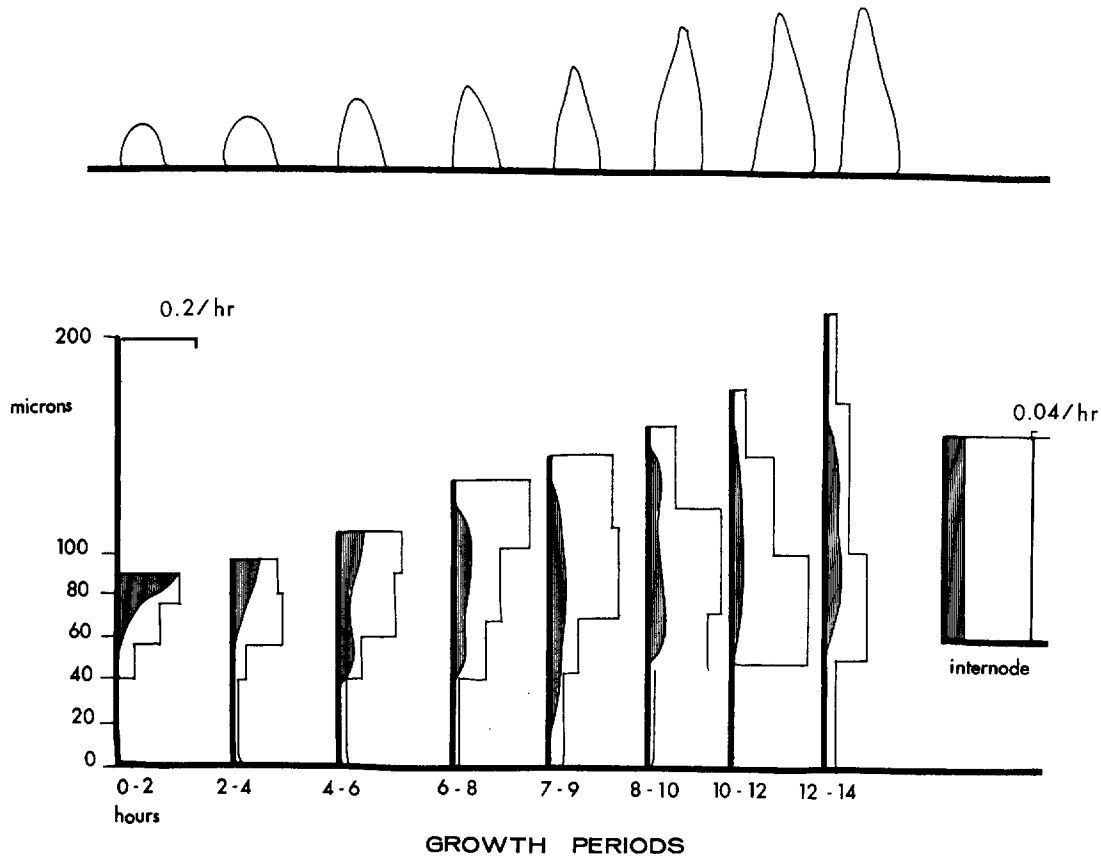

FIGURE 40 Quantitative description of the terminal elongation of leaf apical cell into the conical form. Data from Figs. 35 to 39. Horizontal scale for each graph is the relative rate (transverse component is shaded, longitudinal component is the clear bar graph). Vertical scale is position on the cell. The drop-in rate at the very tip, as soon as it becomes pointed, could be explained by the fact that wall stresses decrease with decreasing radius. They would be minimal at the tip. Note the strong longitudinal anisotropy of expansion in later stages. For comparison, the rate pattern typical of an internode is given at right.

radii the wall would have to be concave downward, which is not the case in his illustration or in *Nitella* (Figs. 25, 26). At any event, the detailed pattern of expansion of the apical cell in *Nitella* is not what Hofmeister assumed to be the case for characean cells. Only in those rare cases in which elongation appears in the base of very large apical cells does the division plane appear to follow his rule. The division generally does support Sachs' rule that partitions tend to intersect the side walls at right angles. The curvature of the new wall, as seen in optical section (Figs. 25, 26), tends to conform with Thompson's (30) configurations for partitions between soap bubbles. These are based, however, on differences in pressure between compartments. The non-spherical character of the

curved new wall (Fig. 25) suggests, however, that no pressure differences exist. The fact that the cross-wall retains its initial diameter until flat suggests that it is being stretched into its transverse configuration.

The division of the segment cell is generally described as being "differential," with the wall being convex upward (31). In our material, this wall actually appears to come in as transverse or even slightly convex downward (Figs. 15, 28), and the curvature of the traditional sort appears only after the subdivision of the node cell.

This investigation has been supported by the National Science Foundation Grant GB 2575.

Many of the concepts presented here were de-

veloped in conversations with Dr. Peter Ray, Department of Botany, University of Michigan, and Dr. R. O. Erickson, Department of Biology, University

of Pennsylvania. The technical assistance of Mrs. Dianne Bert is gratefully acknowledged.

Received for publication, May 13, 1965.

BIBLIOGRAPHY

1. GREEN, P. B., 1964 *a*, Cell walls and the geometry of plant growth, in *Meristems and Differentiation, Brookhaven Symp. Biol.*, 16, 203.
2. HABER, A., and FOARD, D. E., 1963, Non-essentiality of concurrent cell divisions for degree of polarization of leaf growth. II, *Am. J. Bot.*, 50, 937.
3. WHALEY, G., 1961, *Encyclopedia of Plant Physiology*, Berlin, Springer, 14.
4. ERICKSON, R. O., and SAX, K., 1956, Elemental growth rate of the primary root of *Zea mays*, *Proc. Am. Phil. Soc.*, 100, 487.
5. HEJNOWICZ, Z., 1959, Growth and cell division in the apical meristem of wheat roots, *Physiol. Plant.*, 12, 124.
6. Castle, E. S., 1942, Spiral growth and reversal of spirality in *Phycomyces*, and their bearing on primary wall structure, *Am. J. Bot.*, 29, 664.
7. HIRAMOTO, Y., 1958, A quantitative description of protoplasmic movement during cleavage in the sea-urchin egg, *J. Exp. Biol.*, 35, 407.
8. FREY-WYSSLING, A., 1935, *Die Stoffausscheidungen der höheren Pflanzen*, Berlin, Springer, 246.
9. FREY-WYSSLING, A., 1959, *Die Pflanzliche Zellwand*, Berlin, Springer.
10. WILSON, K., 1964, The growth of plant cell walls, *Internat. Rev. Cytol.*, 17, 1.
11. PROBINE, M. C., and PRESTON, R. D., 1962, Cell growth and structure and mechanical properties of the wall in internodal cells of *Nitella opaca*. II, *J. Exp. Bot.*, 13, 111.
12. GREEN, P. B., 1963, On mechanisms of elongation, in *Cytodifferentiation and Macromolecular Synthesis*, (M. Locke, editor), New York, Academic Press, Inc.
13. GREEN, P. B., 1962, Mechanism for plant cellular morphogenesis, *Science*, 138, 1404.
14. LEDBETTER, M. C., and PORTER, K. R., 1963, A "microtubule" in plant cell fine structure, *J. Cell Biol.*, 19, 239.
15. LEDBETTER, M. C., and PORTER, K. R., 1964, Morphology of microtubules of plant cells, *Science*, 144, 872.
16. CRAWLEY, J. C. W., 1965, A cytoplasmic organelle associated with the cell walls of *Chara* and *Nitella*, *Nature*, 205, 200.
17. BARTON, R., 1965, An unusual organelle in the peripheral cytoplasm of *Chara* cells, *Nature*, 205, 201.
18. GREEN, P. B., and KING, A., 1966, A mechanism for the origin of specifically oriented textures in development—special reference to *Nitella* wall texture, submitted to *Austral. J. Biol. Sc.*
19. CASTLE, E. S., 1958, The topography of tip growth in a plant cell, *J. Gen. Physiol.*, 41, 913.
20. ROELOFSEN, P. A., 1959, *The Plant Cell Wall*, Berlin, Gebrüder Borntraeger, 170.
21. STRUNK, C., 1963, Über die Substruktur der Hyphenspitzen von *Polystictus versicolor*, *Z. Allg. Mikrobiol.*, 31, 265.
22. GREEN, P. B., 1964 *b*, Cinematic observations on the growth and division of chloroplasts in *Nitella*, *Am. J. Bot.*, 51, 334.
23. RAPPAPORT, R., 1960, Cleavage of sand dollar eggs under constant tensile stress, *J. Exp. Zool.*, 144, 225.
24. GREEN, P. B., 1958, Structural characteristics of developing *Nitella* internodal cell walls, *J. Biophysic. and Biochem. Cytol.*, 4, 505.
25. PRESTON, R. D., 1964, Structural and mechanical aspects of plant cell walls with particular reference to synthesis and growth, in *Formation of Wood in Forest Trees*, (M. Zimmermann, editor), New York, Academic Press, Inc, 169.
26. MOOR, H., 1964, Die Gefrier-fixation lebender Zellen und ihre Anwendung in der Elektronenmikroskopie, *Z. Zellforsch.*, 62, 546.
27. FROST, H. M., 1964, *Bone Diodynamics*, Boston, Little Brown and Co., Inc., 209.
28. BAZHENOV, V. O., 1961, *Piezoelectric Properties of Wood*, New York, Consultants Bureau, 15.
29. HOFMEISTER, W., 1867, *Die Lehre von der Pflanzenzelle*, Leipzig, Engelmann, 130.
30. THOMPSON, D. A. W., 1917, *On Growth and Form*, Cambridge University Press, 472.
31. FRITSCH, F. E., 1948, *The Structure and Reproduction of the Algae*, Cambridge University Press, 448.
32. SOMA, K., and Ball, E., 1964, Studies on the surface growth of the shoot apex of *Lupinus alba*, in *Meristems and Differentiation, Brookhaven Symp. Biol.*, 16, 13.