

PPAR γ controls CD1d expression by turning on retinoic acid synthesis in developing human dendritic cells

Istvan Szatmari,¹ Attila Pap,¹ Ralph Rühl,¹ Jiang-Xing Ma,⁴ Petr A. Illarionov,⁵ Gurdyal S. Besra,⁵ Eva Rajnavolgyi,² Balazs Dezso,³ and Laszlo Nagy¹

¹Department of Biochemistry and Molecular Biology, ²Department of Immunology, and ³Department of Pathology, University of Debrecen, Medical and Health Science Center, Debrecen H-4010, Hungary

⁴Department of Cell Biology and Medicine, The University of Oklahoma Health Sciences Center, Oklahoma City, OK 73104

⁵School of Biosciences, University of Birmingham, Edgbaston, Birmingham B15 2TT, UK

Dendritic cells (DCs) expressing CD1d, a molecule responsible for lipid antigen presentation, are capable of enhancing natural killer T (iNKT) cell proliferation. The signals controlling CD1 expression and lipid antigen presentation are poorly defined. We have shown previously that stimulation of the lipid-activated transcription factor, peroxisome proliferator-activated receptor (PPAR) γ , indirectly regulates CD1d expression. Here we demonstrate that PPAR γ , turns on retinoic acid synthesis by inducing the expression of retinol and retinal metabolizing enzymes such as retinol dehydrogenase 10 and retinaldehyde dehydrogenase type 2 (RALDH2). PPAR γ -regulated expression of these enzymes leads to an increase in the intracellular generation of all-trans retinoic acid (ATRA) from retinol. ATRA regulates gene expression via the activation of the retinoic acid receptor (RAR) α in human DCs, and RAR α acutely regulates CD1d expression. The retinoic acid-induced elevated expression of CD1d is coupled to enhanced iNKT cell activation. Furthermore, in vivo relevant lipids such as oxidized low-density lipoprotein can also elicit retinoid signaling leading to CD1d up-regulation. These data show that regulation of retinoid metabolism and signaling is part of the PPAR γ -controlled transcriptional events in DCs. The uncovered mechanisms allow the DCs to respond to altered lipid homeostasis by changing CD1 gene expression.

CORRESPONDENCE:

Laszlo Nagy:
lnagy@indi.biochem.dote.hu

Abbreviations used: ADH, alcohol dehydrogenase; ATRA, all-trans retinoic acid; DEAB, 4-diethyl amino-benzaldehyde; FABP, fatty acid-binding protein; GGC, galactosyl(a1-2) galactosylceramide; IHC, immunohistochemistry; LC-MS, liquid chromatography-mass spectrometry; MDC, mature DC; MLR, mixed leukocyte reaction; ox-LDL, oxidized low density lipoprotein; PPAR, peroxisome proliferator-activated receptor; RALDH, retinaldehyde dehydrogenase; RAR, retinoic acid receptor; RDH, retinol dehydrogenase; RSG, rosiglitazone; RT-Q-PCR, real-time quantitative PCR; RXR, retinoid X receptor; SDR, short-chain dehydrogenase/reductase; TGM, transglutaminase.

The discovery of lipid and glycolipid antigen recognition by CD1-restricted T cells defined a new paradigm for immune recognition and host responses to infection. This is based on the fact that certain cellular and bacterial lipids, which bind to CD1 proteins, are able to activate T lymphocytes (1). It was also shown that CD1-restricted T cells have an influence on the outcome of infections caused by viruses, protozoa, and fungi through the recognition of a great variety of lipids (1, 2). CD1 molecules are divided into two groups: group 1 contains CD1a, b, and c and group 2 contains CD1d (3). Group 1 CD1s mediate specific T cell recognition of mycobacterial lipids (1), whereas CD1d is indispensable for the activation of iNKT cells, a conserved subpopulation of NKT cell, characterized by a canonical V α 24/J α 18 TCR α -chain rearrangement and

the preferential usage of V β 11-chain giving rise to a semiinvariant T cell receptor (4). This cell type (iNKT) has been proposed to act as a gatekeeper during the earliest stages of the innate immune response controlling DC differentiation, NK cell activation, and MHC-restricted T cell polarization (2).

DCs serve as regulators of immune responses and are considered the most efficient professional APCs with the unique capability to activate naive T cells (5). CD1 molecules are differentially expressed by various DC subsets; however, the transcription factors or signals that regulate the differentiation of these functionally heterogeneous DC types are poorly defined. Recently, we reported that the activation of PPAR γ , a lipid-activated transcription factor, modulates the phenotype and function of DCs. PPAR γ ligand-treated cells acquire higher phagocytic activity, express more CD1d, and display an enhanced capacity to activate iNKT cells than

The online version of this article contains supplemental material.

untreated cells (6). However, the regulation of CD1d by PPAR γ appears to be indirect, because it takes at least 24 h to develop.

In search of downstream mechanisms, we found and documented here that the key enzymes involved in retinoid metabolism are regulated by PPAR γ in developing DCs leading to all-trans retinoic acid (ATRA) production. ATRA is a ligand for retinoic acid receptors (RARs) and is generated from retinol, a derivative of vitamin A. Retinol is metabolized intracellularly by alcohol dehydrogenase (ADH) and/or short-chain dehydrogenase/reductases (SDR) to retinal, and subsequently retinal is oxidized by retinal dehydrogenases to retinoid acids (7, 8). Retinoids have been shown to modulate the immune response by acting on multiple cell types, but the mechanism of their action is still largely elusive. Retinoids are able to modify DC differentiation, they promote apoptosis of DCs by an RAR α -dependent pathway, and they enhance the maturation of DCs via a retinoid X receptor (RXR)-dependent and an RAR α -independent mechanism (9). A subtype of gut DCs can produce ATRA and regulates T cell homing (10). Here we describe a mechanism that utilizes PPAR γ and

RAR signaling pathways in human monocyte-derived DCs to control CD1d expression and iNKT activation in response to lipids.

RESULTS

Activation of PPAR γ induces the expression of genes involved in retinoic acid biosynthesis

We have characterized the gene expression profile of PPAR γ -activated DCs using Affymetrix GeneChips looking for PPAR γ -regulated metabolic and signaling pathways. Our global analyses revealed that PPAR γ ligand modulates the expression of genes, which participate in lipid metabolism (*fatty acid-binding protein [FABP]4, ADRP, LXR α*) and lipid antigen presentation (*CD1a, CD1d*) in monocyte-derived DCs (6). Unexpectedly, we observed that several genes involved in all-trans retinoic acid (ATRA) biosynthesis (Fig. 1 A) were also up-regulated by treatment of DCs with rosiglitazone (RSG), a synthetic PPAR γ activator (Fig. 1 B). All of the identified retinol dehydrogenases, regulated by RSG treatment, are members of the SDR protein family. Several of them catalyze only the reduction of retinal, i.e., DHRS3 (11), whereas DHRS9 and retinol

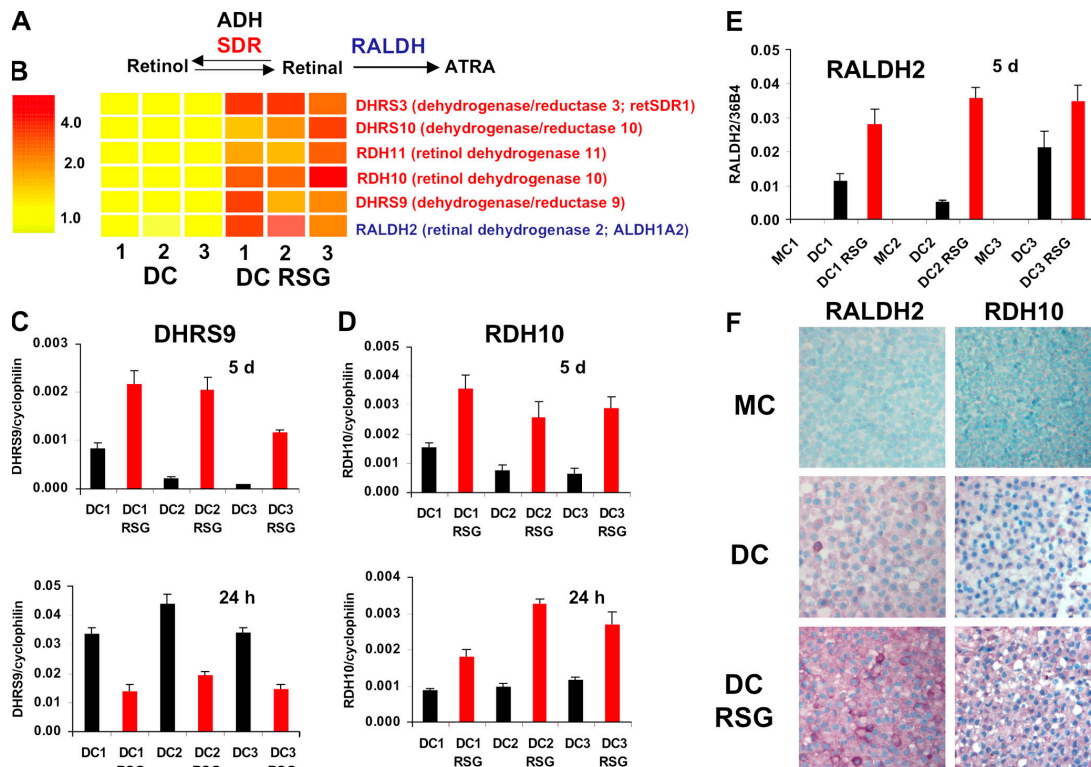

Figure 1. Activation of PPAR γ induces the expression of RDH10 and RALDH2. (A) The retinoic acid biosynthesis pathway. (B) Expression profile of genes involved in retinoid metabolism in control or 2.5 μ M rosiglitazone (RSG)-treated DCs. mRNA levels were determined by Affymetrix GeneChips (Hu133 2.0 Plus), and expression was normalized to control cells. Heatmap shows expression levels; control levels are shown in yellow. RNAs were obtained from three donors. Transcript level of DHRS9 and RDH10 (C and D, respectively) was determined from control

DCs or cells treated with 2.5 μ M RSG by RT-Q-PCR. Samples were obtained from three donors. Cells were harvested at the indicated time points (5 d or 24 h). (E) The mRNA level of RALDH2 was determined from monocytes (MC), control DCs, or cells treated with 2.5 μ M RSG. Samples were obtained from three donors. (F) Protein expression of RALDH and RDH10 was determined from monocytes (MC), DCs, or cells treated with 2.5 μ M RSG by IHC using pelleted cells as described in Materials and methods.

dehydrogenase (RDH)10 are able to catalyze retinol oxidation (12, 13) and thus may participate in the conversion of retinol to retinal (Fig. 1 A). The conversion of retinal to ATRA can be catalyzed by retinaldehyde dehydrogenase type 2 (RALDH2), which also appeared to be regulated by PPAR γ . These findings prompted us to investigate the relationship of PPAR γ , retinoid metabolism, and retinoid signaling in monocyte-derived DCs. First, we validated the enhanced gene expression of retinol dehydrogenases by real-time quantitative PCR (RT-Q-PCR). Elevated levels of mRNA expression of DHRS9 and RDH10 were detected in RSG-treated DCs after 5 d of differentiation (Fig. 1, C and D). To further characterize the onset of enzyme expression, we measured mRNA levels at earlier time-points. We reasoned that for a certain enzymatic reaction to contribute to DC differentiation and/or subtype specification it must be induced early during differentiation. Interestingly, only RDH10 was induced as early as 24 h (Fig. 1 D), suggesting that the PPAR γ -regulated component of retinol oxidation might be *RDH10*. We also looked at the expression of the protein product of this gene and found an elevated level of RDH10 enzyme detected by immunohistochemistry (IHC) (Fig. 1 F). These results suggested that PPAR γ -activated cells are likely to acquire an increased retinol to retinal conversion capacity. Our RT-Q-PCR data also revealed that RALDH2 (also known as ALDH1A2), the enzyme responsible for converting retinal to retinoic acid,

was up-regulated upon PPAR γ activation (Fig. 1 E). This effect was confirmed by IHC, which showed elevated protein expression of RALDH (Fig. 1 F) using an anti-RALDH antibody, which can detect RALDH1 or RALDH2. It should be noted that the mRNA expression of RALDH1 was very low in monocyte-derived DCs (unpublished data), suggesting that the detected signal is from RALDH2. Collectively, our results indicated that some key proteins, responsible for bioactive retinoid synthesis, are coordinately up-regulated in PPAR γ -instructed DCs.

PPAR γ instructs DCs to produce ATRA

To obtain direct evidence that PPAR γ ligand-treated DCs could generate retinoids we determined the intracellular ATRA concentrations by using a sensitive and specific liquid chromatography-mass spectrometry (LC-MS) method (14). Untreated DCs produced very low levels of ATRA, but an elevated amount of ATRA was detected in RSG-treated DCs (Fig. 2 A). This accumulation appeared to be PPAR γ dependent, because a PPAR γ antagonist (GW9662) blocked it. The estimated ATRA concentration (0.8–1.2 ng/g cell pellet, equivalent to 2–5 nM) was well within the range to activate RARs (Fig. 2 B). The concentration of all-trans retinol, the precursor of ATRA, was also determined in the cells, and no difference was detected between treated and control samples (20–30 ng/g cell pellet). In addition, a similar retinol

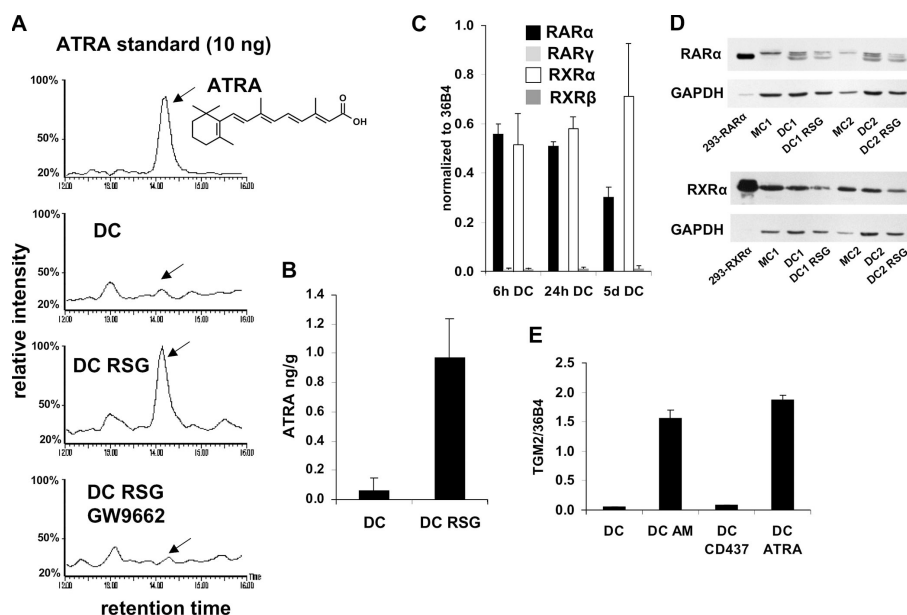

Figure 2. PPAR γ -activated DCs produce ATRA. (A) Control (DC), RSG-treated (2.5 μ M), or RSG plus GW9662-treated (5 μ M) cells were cultured for 5 d and pooled from three donors (50–100 mg cell pellet). Concentrations of ATRA were determined with the LC-MS method. The ATRA peak is marked by an arrow. (B) Quantitative determination of ATRA from DCs and RSG-treated DCs. Data were obtained from four independent experiments \pm SD. (C) Expression pattern of RAR α , RAR γ , RXR α , and RXR β in monocyte-derived DCs. Transcript levels were determined in

DCs at the indicated time-points by real-time RT-Q-PCR using TLDA assays (Applied Biosystems). (D) Western blot analysis of RAR α and RXR α protein expression in DCs. The identity of the 50-kD bands was confirmed by comigration with a band in the cell extract (2 μ g) of RAR α - or RXR α -transduced 293T cells. Samples were obtained from two donors. GAPDH was used as a loading control. (E) TGM2 is up-regulated by RAR α agonist. Cells were treated with 100 nM AM580 (AM), 100 nM CD437, or 100 nM ATRA. Transcript levels were determined by RT-Q-PCR.

concentration was detected in the culture medium (unpublished data). These data strongly suggested that activation of PPAR γ leads to ATRA production and potentially to retinoid-regulated gene expression. In other words, it appeared likely that part of the PPAR γ -induced changes in gene expression are indeed retinoid mediated. Next, we embarked on evaluating this scenario. The effects of retinoids on gene expression are mediated by nuclear receptors (RARs α , β , and γ and RXRs α , β , and γ) (15). We assessed the transcript levels of these receptors in differentiated DCs. We observed that RAR α and RXR α were highly expressed, tested both at mRNA (Fig. 2 C) and protein levels (Fig. 2 D), whereas RXR β and RAR γ were barely detectable. We failed to detect RAR β or RXR γ (unpublished data). These results indicated that the RAR α -RXR α heterodimer is likely to be the dominant retinoid receptor in developing DCs. To assess the function of these receptors we monitored the mRNA level of *tissue transglutaminase* (*TGM2*), a well-established retinoid receptor target gene (16). We examined the effects of retinoids in developing DCs by using synthetic and natural RAR agonists. ATRA, a natural ligand of RARs, and AM580, an RAR α selective synthetic ligand, strongly induced the expression of *TGM2*, but the RAR γ -specific agonist (CD437) did not (Fig. 2 E). These findings implied that PPAR γ -treated DCs produce ATRA, and endogenous accumulation of this compound might trigger the retinoid response by the activation of the RAR α nuclear hormone receptor.

Part of PPAR γ -regulated gene expression is a result of retinoid signaling in DCs

Our data provided several hints that activation of PPAR γ induces a retinoid response in human DCs. (a) Key proteins responsible for bioactive retinoid synthesis are up-regulated in PPAR γ -instructed DCs. (b) PPAR γ ligand-treated cells produce a detectable amount of ATRA. (c) Retinoid target genes, i.e., *TGM2* and *DHRS3* (17), were induced by PPAR γ ligand (Fig. 1 B and unpublished data). To assess the contribution of retinoid signaling to the PPAR γ response we decided to use a combination of pharmacological activators and inhibitors of these pathways along with an unbiased approach—global gene expression profiling. Cells were treated with the synthetic PPAR γ ligand RSG, or with RSG along with the RAR α antagonist (AGN193109), to block RAR α -mediated gene expression, or the RAR α -specific agonists (AM580) alone. This design allows one to determine if retinoid signaling is a downstream event of PPAR γ activation and what portion of PPAR γ -regulated genes is regulated via induced retinoid signaling. We found that 553 probe sets were significantly changed in a PPAR γ -dependent manner (microarray analyses are described in the supplemental Materials and methods, available at <http://www.jem.org/cgi/content/full/jem.20060141/DC1>). Datasets are available in the public Gene Expression Omnibus database (accession no. GSE5679). We performed K-means clustering to find characteristic gene expression patterns. Six clusters were generated by this analysis

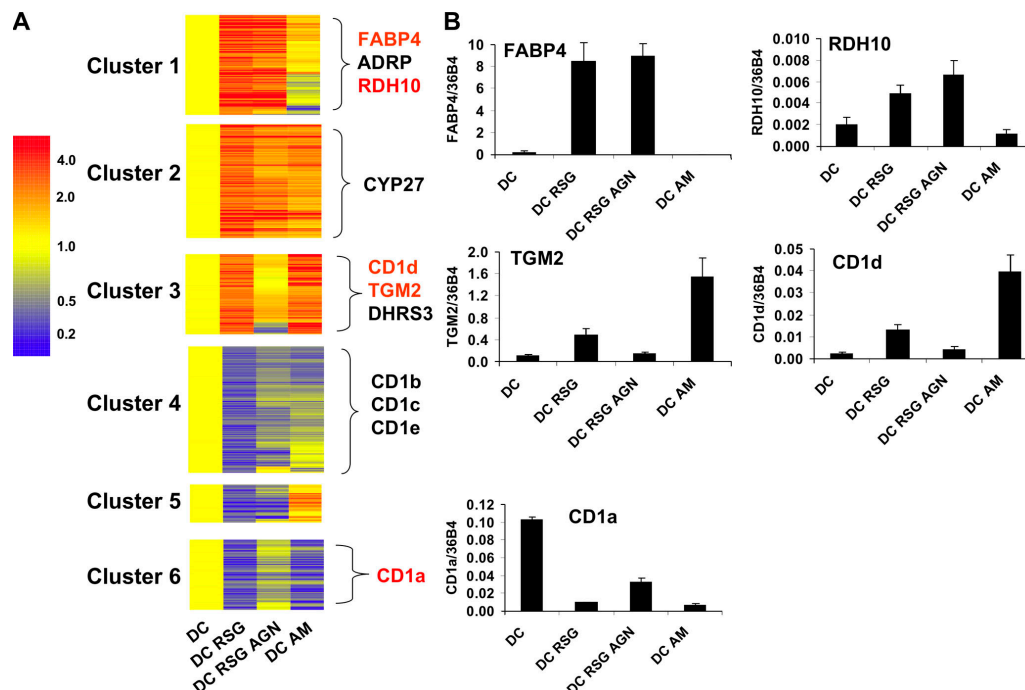

Figure 3. Comparative gene expression profile of PPAR γ and RAR α ligand-treated DCs. (A) Microarray data were obtained from vehicle (DC) or ligand treated DCs: 2.5 μ M RSG, 1 μ M AGN193109 (AGN), 100 nM AM580 (AM). Data analyses are described in detailed in the sup-

plemental Materials and methods. Gene expression was normalized to control DCs. Heatmap shows gene expression level. (B) Transcript levels of FABP4, RDH10, TGM2, CD1d, and CD1a were determined with RT-Q-PCR. Cells were treated as described above.

(Fig. 3 A); cluster 1 contains probe sets, which were exclusively PPAR γ ligand regulated. The RAR α antagonist did not decrease and the RAR α agonist did not increase the expression of these genes. In this cluster several established PPAR γ -responsive genes such as *FABP4* and *ADRP* were found; in addition, the newly identified target gene *RDH10* was also in this group. Our quantitative PCR analysis confirmed that *FABP4* and *RDH10* were regulated only by PPAR γ agonist (Fig. 3 B). In cluster 3 (see gene list in Table S1, available at <http://www.jem.org/cgi/content/full/jem.20060141/DC1>) gene expression was regulated by both ligands, and the RAR α antagonist abolished the effect of the PPAR γ ligand. As expected, *TGM2* was in this cluster, but surprisingly the previously characterized PPAR γ -regulated gene, *CD1d* (6), also fell into this category. These genes appeared to be regulated indirectly by PPAR γ via the activation of retinoid signaling. RT-Q-PCR validation of these findings indicated that the gene expression pattern of *CD1d* was very similar to that of *TGM2* (Fig. 3 B), suggesting that *CD1d* is indeed regulated in an RAR α -dependent manner. We also identified several genes, which were induced independently by either of the two types of ligands (cluster 2). Interestingly, a p450 enzyme, *CYP27*, was also in this group. We have previously analyzed the promoter region of this gene (18) and have now confirmed that it is regulated by either PPAR γ or RAR. We obtained a similar set of expression patterns when we analyzed the down-regulated genes. Most prominently,

cluster 6 contains probe sets of genes down-regulated by PPAR γ ligand. This effect is abolished in the presence of the RAR α antagonist (see gene list in Table S2, available at <http://www.jem.org/cgi/content/full/jem.20060141/DC1>). *CD1a* belong to this group, and the expression of *CD1a* was confirmed using RT-Q-PCR. If taken together, our global gene expression profiling data implies that $\sim 30\%$ of all PPAR γ ligand-responsive genes are regulated via the induction of retinoid signaling. Thus, PPAR γ -regulated retinoid production significantly contributes to both induced and inhibited gene expression in DCs.

PPAR γ -mediated *CD1d* induction requires induced retinoic acid synthesis

The finding that RAR α antagonist abolished PPAR γ ligand-induced *CD1d* expression suggested that the link between PPAR γ and retinoid signaling is likely to be at the level of induced retinoid production. If this argument is correct, increased intracellular ATRA levels should correlate with the expression of *CD1d* in PPAR γ ligand-treated DCs. We have performed time course experiments to address this. As shown in Fig. 4 A, the time course of intracellular ATRA production matches the induction of *CD1d*, providing further evidence that there is a causative relationship between retinoic acid production and *CD1d* induction. To gain further mechanistic insights, we used pharmacological means to probe the contribution of enzymatic steps in the regulation of

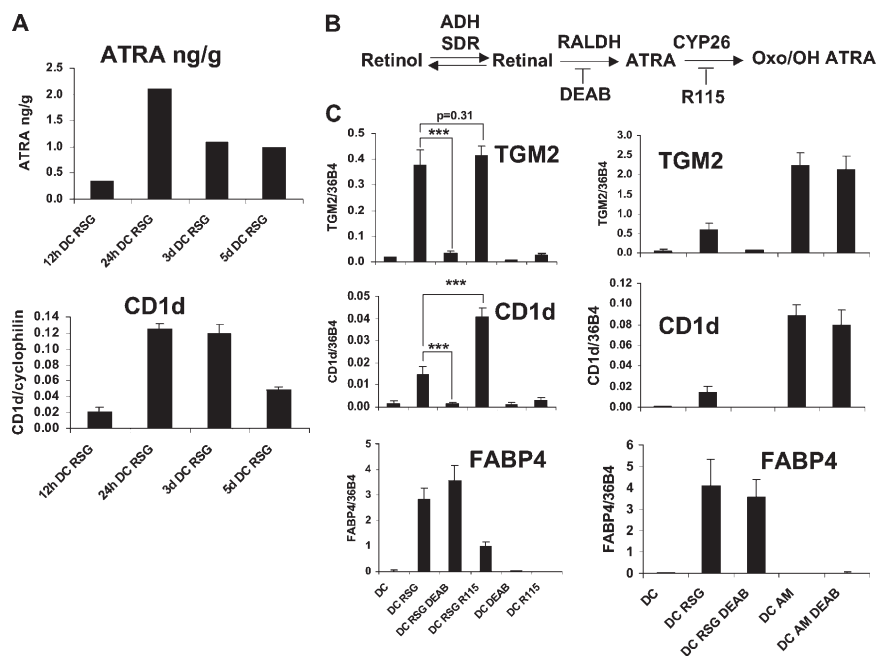

Figure 4. Inhibition of retinoid synthesis blocks PPAR-dependent *CD1d* and *TGM2* induction. (A) Quantitative determination of ATRA concentration from RSG-treated DCs. Cells were treated with 2.5 μM RSG harvested at the indicated time points; cell pellets from eight donors (top). Determination of *CD1d* transcript level from RSG-treated DCs. Cells were treated as described above; mRNA level was determined by RT-Q-PCR

(bottom). (B) ATRA biosynthesis and degradation pathway. Oxo/OH ATRA, oxo/hydroxi ATRA; CYP26, cytochrome p450 retinoic acid 4-hydroxylase; R115, R115866. (C) Transcript levels of *TGM2*, *CD1d*, and *FABP4* were determined from DCs treated with various ligands: 2.5 μM RSG, 10 μM 4-diethyl amino-benzaldehyde (DEAB), 1 μM R115866 (abbreviated as R115), and 100 nM AM580 (AM) *** $P < 0.001$.

gene expression. We used inhibitors of the enzymatic steps involved in retinoic acid synthesis. Retinal is converted to ATRA by aldehyde dehydrogenases (Fig. 4 B). This step can be blocked by 4-diethyl amino-benzaldehyde (DEAB) (19), an inhibitor of RALDHs. ATRA is inactivated by CYP26, a p450 enzyme. This step can be inhibited by R115866, a specific CYP26 inhibitor (20). We used these inhibitors in combination with activators of PPAR γ or RAR α . As a readout of activation, we measured the expression of the PPAR γ target gene *FABP4* and the RAR α -regulated genes *TGM2* and *CD1d*. We found that PPAR γ ligand-mediated induction of *CD1d* and *TGM2* was completely abolished by RALDH inhibitor (DEAB) treatment. Conversely, administration of R115866 (abbreviated as R115) led to an enhanced expression of *CD1d* (Fig. 4 C). At the same time DEAB did not abolish the induction of *FABP4*, indicating that this compound is not a general inhibitor of PPAR γ -induced gene expression. We also examined the effect of RALDH inhibitor on *CD1d* and *TGM2* expression upon retinoid treatment. When cells were cotreated with the synthetic RAR α agonist AM580, DEAB had no effect on the induction (Fig. 4 C). These data provided further support for the argument that endogenously generated ATRA is likely to be responsible for *TGM2* and *CD1d* induction by PPAR γ ligands.

CD1d is acutely up-regulated by the activation of the RAR α receptor

One of the unanticipated findings of our global gene expression analyses was that both *CD1d* and *CD1a* were regulated by PPAR γ in an RAR-dependent manner. Next, we wanted to gain more insight into how retinoic acid and its receptor (RAR α) regulated *CD1d* gene expression. First, we compared the time courses of *CD1d* induction by PPAR γ activators and retinoids. We reasoned that if retinoid-induced *CD1d* expression is downstream of PPAR γ , then there must be a shift between the two time courses. It appears to be the case, because activation of RAR α induced expression of *CD1d* already after 1 h, suggesting the involvement of a direct transcriptional event (Fig. 5 A), whereas PPAR γ ligand administration did not up-regulate the expression of *CD1d*

within this time interval as we have previously reported (6). This expression pattern is consistent with an indirect mechanism triggered by PPAR γ activation. The analysis of *CD1d* expression, however, is complicated by the fact that freshly isolated monocytes also express large amounts of *CD1d*; thus, it is difficult to determine whether retinoids elicit a net induction or block the down-regulation of *CD1d*. To circumvent this issue we added the activators after 12 h of DC differentiation (when *CD1d* expression is already low). Significantly, we detected an early and robust induction of *CD1d* by retinoids (Fig. 5 B). In contrast, to this prompt effect, PPAR γ ligand failed to activate this gene after 2 h. To see if retinoids have similar effects in cell types other than monocyte-derived DCs we extended our studies into other DC models. We characterized the expression of *CD1d* in blood DCs. We isolated *CD1c*⁺ myeloid DCs from monocyte-depleted PBMCs (6). Cultured blood DCs express low amount of *CD1d*, but *CD1d* was highly up-regulated upon retinoid (AM580) treatment (Fig. 5 C). PPAR γ activator was also effective albeit much less potent. Based on the evidence presented here, we propose that the effect of retinoids on *CD1d* gene expression is likely to be a “proximal” direct transcriptional event and the PPAR γ -dependent regulation of *CD1d* is indirectly mediated through the activation of retinoid signaling.

Retinoid-treated DCs have an improved lipid presentation capacity

We and others have recently shown that the expression of the *CD1* gene family is coordinately regulated by PPAR γ activators. PPAR γ ligand-treated DCs express a reduced level of *CD1a*, whereas the level of *CD1d* is increased upon ligand treatment (6, 21). Our results presented here argued strongly for the possibility that some of the regulation on *CD1* expression is mediated by retinoid signaling. Therefore, we decided to compare the effects of retinoids and PPAR γ activators on the expression of cell surface molecules of DCs. We sought to characterize the retinoid-regulated events and compare those to PPAR γ -regulated processes. First, we looked at the cell surface expression of *CD1a* and *CD1d*.

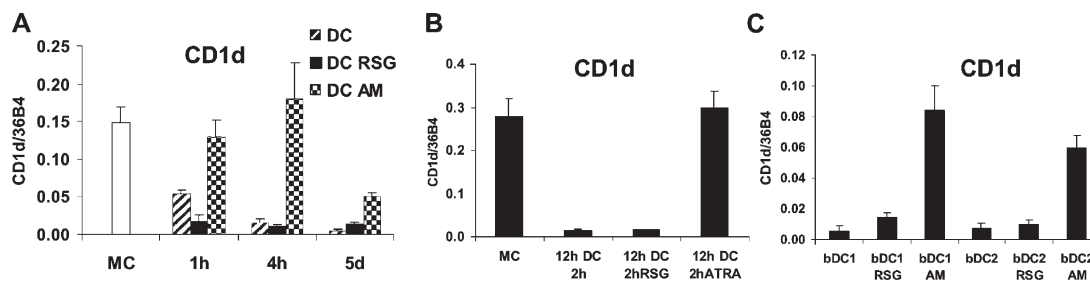

Figure 5. CD1d is rapidly and robustly induced by retinoids, and CD1d is also up-regulated in blood DCs by retinoid treatment. (A) Time course of regulated CD1d expression. Cells were treated with 1 μ M RSG or 100 nM AM580, harvested at the indicated time points, and mRNA expression was determined by RT-Q-PCR. (B) Determination of CD1d mRNA level upon acute

retinoid treatment. Monocytes were cultured for 12 h, thereafter treated with 100 nM ATRA or 1 μ M RSG, and harvested after 2 h. (C) CD1d transcript level was determined from blood-derived DCs (bDCs) cultured for 2 d. Cells were treated with 1 μ M RSG or 100 nM AM580 (AM); transcript levels were determined by RT-Q-PCR. Samples were obtained from two donors.

Consistent with the mRNA expression pattern membrane, CD1d was up-regulated, whereas CD1a was down-modulated by both RAR α and PPAR γ ligands (Fig. 6 A). Importantly and also consistent with the mRNA expression pattern, we observed that RSG-elicited induction of CD1d was abolished by a RALDH inhibitor (DEAB) (Fig. 6 A). Next, we looked at the functional consequences of retinoid-regulated gene expression. CD1d can present lipid antigens to a specific T cell subtype, iNKT cells, which have the potential to regulate both inflammatory and anti-inflammatory responses through the rapid secretion of cytokines (4). We assessed the ability of DCs to induce iNKT cell proliferation in autologous mixed leukocyte reaction (MLR) cultures. DCs were loaded with a synthetic CD1d ligand (α -GalCer) (22) for 24 h followed by a co-culture with autologous PBMCs for 5 d. We found that either RAR α or PPAR γ activation leads to a DC subtype, which has an increased capacity to promote the expansion of iNKT cells (Fig. 6, B and C). In addition, we also loaded the cells with galactosyl(a1-2) galactosyl-ceramide (GGC), a lipid precursor of the α -GalCer antigen, which requires delivery to the lysosomes where it is hydrolyzed and

converted to the active glycolipid (α -GalCer) (23). PPAR γ or RAR α receptor agonist-treated DCs elicited an enhanced iNKT expansion when the cells were loaded with this precursor of α -GalCer (Fig. 6 D), indicating that activation of these pathways enhance the lipid antigen-presenting capacity independent of processing and endosomal loading. To provide further evidence that ligand-instructed DCs could activate iNKT cells we measured INF γ secretion of purified iNKT cells, activated by α -GalCer-loaded DCs, by ELISPOT analysis. We found that both RAR α and PPAR γ ligand-treated DCs trigger an enhanced INF γ response of iNKT cells (Fig. 6 E). Our results demonstrated that both PPAR γ - and RAR α -specific ligand-treated DCs express CD1d that is able to present α -GalCer for iNKT cells to elicit their activation. It should be noted that ligand-treated DCs without exogenous glycolipid loading failed to elicit any iNKT cell expansion (Fig. 6, C and D).

Besides presentation of lipid antigens, DCs are highly active in the presentation of processed peptides by MHC class I and/or class II proteins. The question remained whether activation of either the PPAR γ or the RAR α pathways had an

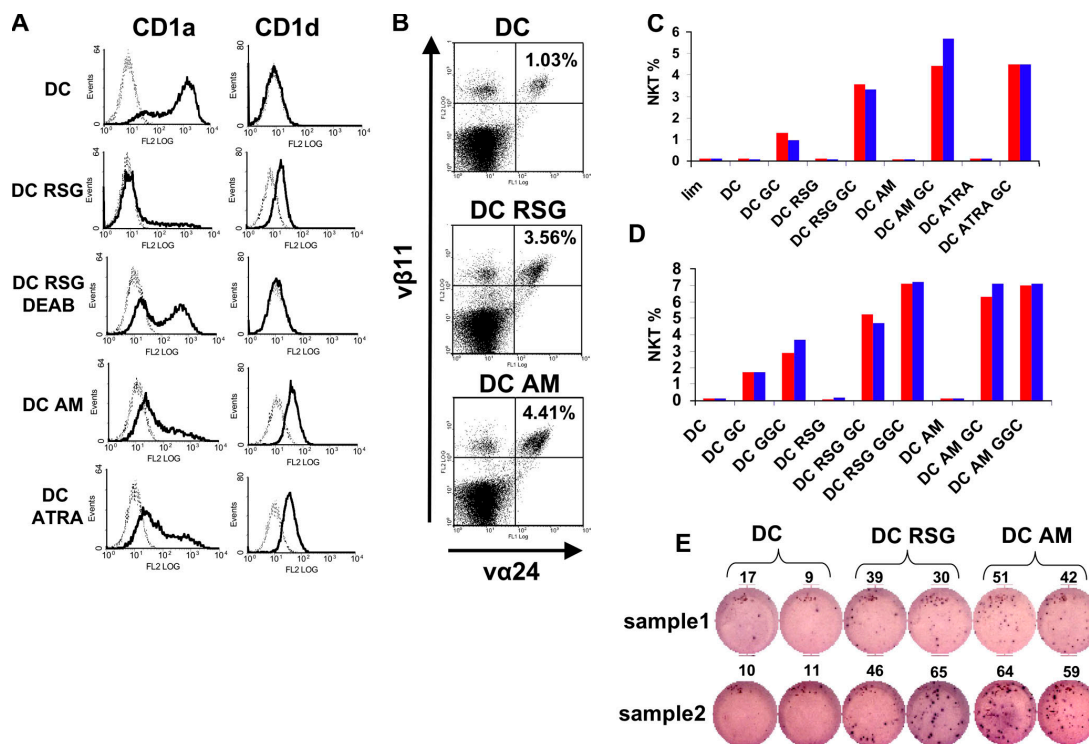

Figure 6. Retinoid-treated DCs express CD1d and promote the expansion and activation of iNKT cells. (A) PPAR γ and RAR α ligand-treated cells express more CD1d and less CD1a compared to control cells. Cells were treated with various ligands: 2.5 μ M RSG alone, or along with 10 μ M DEAB, 100 nM AM580 (AM), or 100 nM ATRA. Specific mAb (solid line) versus isotype control (dotted line) is presented. (B) Ligand-treated (2.5 μ M RSG or 100 nM AM580) DCs were pulsed with 100 ng/ml α -GalCer for 24 h, and then DCs were washed and cocultured with autologous PBMCs for 5 d. Cells

were stained by iNKT antibodies (anti-V β 11-PE and anti-V α 24-FITC). (C and D) Cells were treated with the following ligands: 2.5 μ M RSG, 100 nM AM580, or 100 nM ATRA, and cells were pulsed with 100 ng/ml α -GalCer (GC) or with 100 ng/ml GGC for 24 h. The percentage of NKT was determined as described above. We performed a duplicate measurement (blue and red color). (E) Detection of iNKT activation by INF γ ELISPOT. α -GalCer-pulsed DCs were cocultured with iNKT cells for 16 h in human INF γ ELISPOT plates. Cells were treated with 2.5 μ M RSG (DC RSG) or with 100 nM AM580 (DC AM).

effect on MHC-mediated T cell activation. PPAR γ ligand-activated immature DCs exhibit an elevated expression of MHC class II molecules (21). We confirmed these results and extended them by phenotyping retinoid (ATRA or AM580)-treated cells in combination with measuring MHC class I (HLA-ABC) membrane expression. Retinoid-treated cells showed a similar HLA-DR expression pattern to PPAR γ -activated cells. Both ligands stimulated the cell surface expression of HLA-DR, suggesting that these cells might have a generally enhanced capacity to present peptide antigens (Fig. S1 A, available at <http://www.jem.org/cgi/content/full/jem.20060141/DC1>). In contrast to CD1s, the cell surface expression of MHC II was highly up-regulated upon maturation/activation of DCs (24), and it was also suggested that retinoid-treated DCs had a mature/activated phenotype (9, 25). Consistent with this finding we also found that in immature DCs the cell surface expression of HLA-DR was increased upon retinoid treatment, but the bona fide maturation marker (CD83) was not detected (unpublished data). It is possible that enhanced HLA-DR expression is just a marker of the activation state of these cells, and its expression can be further elevated by proinflammatory cytokines. Indeed, we found that mature DCs (MDCs) exhibited elevated expression of HLA-DR, which was not modified by retinoids (Fig. S1 B). We also investigated the cell surface expression of HLA-ABC and found that both immature and mature DCs express high levels of MHC class I molecules not modified by ligand treatment. To see if activation of RAR α had any

effect on DC-mediated T cell activation we compared the intensity of MLR reactions induced by mature DCs generated with or without RAR α or PPAR γ agonist. We failed to observe any change in the level of MHC-dependent T cell activation using control or ligand-treated MDCs in an allogeneic MLR test (Fig. S1 C). We concluded that activation of these nuclear receptors did not confer enhanced antigen-presenting capacity per se, but the activated cells acquired a selectively enhanced NKT cell activating capacity caused by elevated levels of membrane CD1d accompanied by decreased CD1a expression.

Activation of retinoid signaling by natural PPAR γ activators

Our studies uncovered an interrelated network of lipid signaling processes regulating DC gene expression and function including lipid antigen presentation. An intriguing question remained, however, whether natural sources of PPAR γ activators such as oxidized low density lipoprotein (oxLDL) or other lipids (26) were able to elicit retinoid signaling in DCs, providing a biological context and significance for these mechanisms. To test this hypothesis differentiating DCs were treated with oxLDL alone or in combination with RAR antagonist or RALDH inhibitor, and the expression pattern of retinoid and PPAR γ -regulated genes was measured. oxLDL treatment induced the expression of CD1d, TGM2, and FABP4 (Fig. 7 A). Treatment with the RAR antagonist and RALDH inhibitor blocked the up-regulation of TGM2 and CD1d, suggesting that retinoid signaling was

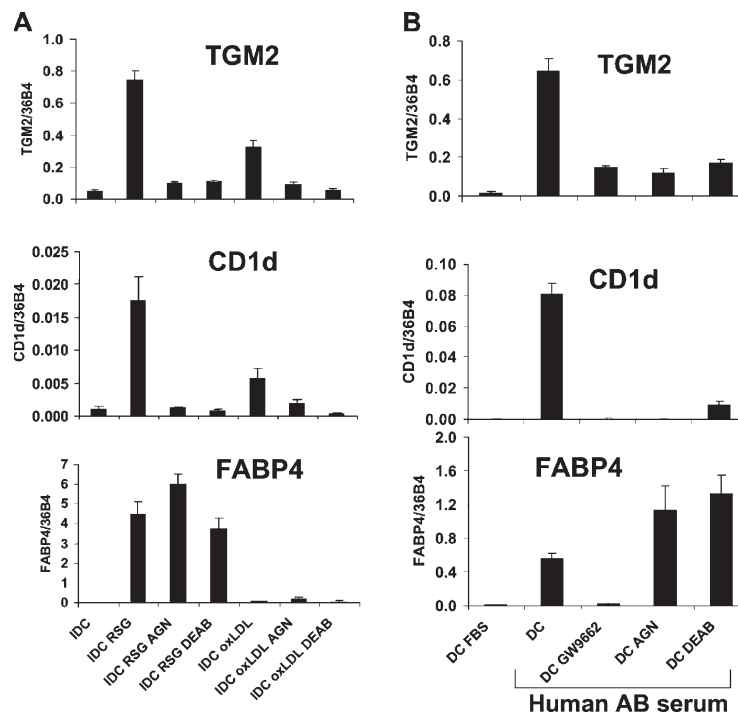

Figure 7. Natural PPAR γ agonists confer retinoid response to human DCs. (A and B) Transcript levels of TGM2, CD1d, and FABP4 were determined by RT-Q-PCR after treatment with the following ligands:

100 nM AM580 (AM), 2.5 μ M RSG, 1 μ M AGN193109 (AGN), 5 μ M GW9662, 10 μ M DEAB, or 20 μ g/ml oxidized low density lipoprotein (oxLDL). The indicated samples were cultured in human AB serum.

involved, but it did not block the up-regulation of FABP4. It is important to note, however, that lipoproteins besides PPAR γ activators might also contain retinyl-esters or other retinoid precursors (27, 28), and these compounds might participate in the activation of retinoid signaling independent of the activation of the PPAR γ receptor. To test this we also analyzed the retinoid content of oxLDL by LC-MS. Although we could detect various retinyl-esters, only trace amounts of retinol was found and no ATRA was detected in 100 mg of oxLDL. Our lipid analyses also indicated that several oxidized retinoid species were present (unpublished data). These data imply that oxLDL is likely to contain retinoic acid precursors that can be converted to ATRA inside cells and elicit retinoid signaling. The conversion of this (these) precursor(s) are also, at least in part, under the control of PPAR γ . In addition, we have previously defined a serum condition (human AB serum), which either contains and/or induces endogenous PPAR γ ligands/activators (6). Next we tested if this source of PPAR γ activators induced retinoid signaling. In DCs cultured in the presence of human AB serum an elevated level of FABP4, TGM2, and CD1d was detected (Fig. 7 B). The PPAR γ -specific antagonist (GW9662) efficiently decreased the transcript level of all of these genes. Importantly, administration of RAR antagonist or RALDH inhibitor (DEAB) diminished the expression of TGM2 and CD1d but not that of FABP4 (Fig. 7 B). These experiments collectively demonstrated that activation of PPAR γ by biologically relevant normal or pathological serum lipids can also elicit a retinoid response, and it appears likely that in vivo these lipids might be relevant sources of CD1d regulation.

DISCUSSION

Lipid exposure to APCs, including DCs, has fundamental effects on their differentiation and immune function (2). The molecular, and in particular, the transcriptional mechanisms contributing to these changes are not well understood. Here we describe a network of regulatory processes involving two lipid-activated transcription factors, PPAR γ and RAR α , controlling CD1 gene expression and lipid antigen presentation in human developing DCs. Based on the data presented, the following model is emerging: if the lipid environment is permissive for PPAR γ receptor activation (i.e., exposure to synthetic PPAR γ ligands, oxidized LDL, or human serum), the expression of several genes (*RDH10* and *RALDH2*), acting at subsequent stages of retinoid metabolism, are induced. *CD1d* along with other retinoid targets gets induced and another set of genes including *CD1a* is down-modulated (Fig. 8), bringing about functional changes in lipid antigen-presenting capacity of DCs and iNKT cell activation. The described pathway might be induced by activation of either one or both of the receptors allowing for graded and/or synergistic regulation. As a result, the gene expression pattern and the functions of DCs will be changed depending on the intracellular and extracellular lipid environment.

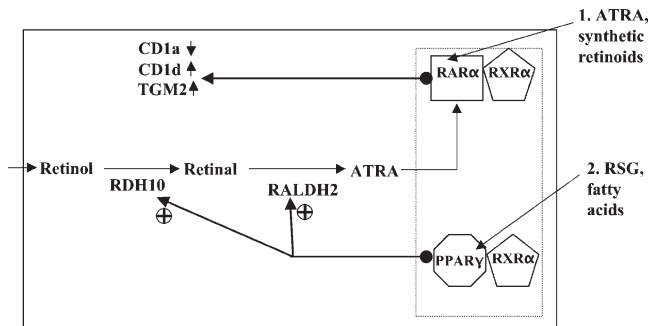

Figure 8. Regulation of gene expression, including CD1d expression, by the activation of nuclear hormone receptors in developing DCs. 1. ATRA or synthetic RAR α agonist acutely induces CD1d expression. 2. Generation of ATRA and enhanced retinoid signaling in PPAR γ ligand-treated DCs.

Regulated production of all-trans retinoic acid in DCs

In vivo, endogenous retinol metabolism is a tightly controlled process (7, 8); however, it is largely unknown which type of immune cells are able to generate the active form of vitamin A. It was recently shown that murine intestine-associated DCs could produce retinoids, but DCs from other tissues failed to produce ATRA (10). In addition, several retinol/retinal metabolizing enzymes were detected in intestinal DCs. In our studies, we identified several genes participating in retinoid metabolism in human DCs, which had an increased expression level in cells treated with PPAR γ activators. Time course experiments and receptor selective inhibitors helped to establish that PPAR γ acted upstream of retinoid signaling. One of the regulated steps, *RDH10* expression and activity, can initiate ATRA production in a PPAR γ -dependent manner. We also observed that the expression of *RALDH2* was highly increased during DC development, and PPAR γ ligand-treated cells showed a further elevated level. Therefore, it is very likely that *RALDH2* is required for the enhanced production of ATRA. These data also suggest that retinoid production is not an inherent characteristic of DCs but an acquired/regulated one. Our data support a model for such controlled retinoid production and signaling in human DCs and suggests that ligand activation of PPAR γ is acting as one of the regulators. In our case, ~30% of the gene expression changes are caused by induced retinoid signaling. Besides *CD1d*, several other transcripts get up-regulated in this way (i.e., *DHRS3*, *fibronectin*, *TGM2*), suggesting that this regulatory mechanism can modulate other pathways that might have roles in DC function.

Biological roles for PPAR γ -controlled retinoid production

It is also conceivable that the produced lipid mediators such as retinoids are exported from the cells and modify the function of exposed neighboring cells. DCs interact with almost all types of immune cells and are important regulators of both adaptive and innate immune responses while controlling immunological tolerance. DCs collaborate also with epithelial cells, and much of their effects are implemented at the interface

of DC and lymphocytes. Retinoids have been shown to have a profound effect on T cell activation (29). One could speculate that locally generated ATRA by PPAR γ -activated DCs, besides acting in DCs, if exported, might also influence the functions of local cells, such as epithelial cells (30, 31), monocytes, and B and T lymphocytes. It is also plausible that the small intestine is the place where intense lipid traffic occurs and PPAR γ activators can be generated. We have preliminary data to suggest that some of the DCs of Peyer's patches are PPAR γ positive, and these cells also express RALDH and are likely to generate retinoids in a regulated manner. Remarkably, all the PPAR γ positive cells coexpress TGM2, a bona fide retinoid target gene, strongly suggesting that these cells have active retinoid signaling and that PPAR γ -positive DCs in Peyer's patches is an *in vivo* identifiable and thus relevant cell type (unpublished data).

The regulatory effects of exogenous lipids from physiological and pathological sources

Mediators (such as oxLDL, prostaglandins, and other serum lipids) of PPAR γ activation might switch on this pathway leading to retinoid generation provided that precursors are also present. In fact, we observed that oxLDL promoted CD1d induction in human DCs via activation of retinoid signaling. It is very intriguing to speculate that turning on the lipid-presenting molecule CD1d and lipid antigen production and presentation might also be linked. It was recently shown that lipoproteins can promote the delivery of exogenous glycolipid antigens to the CD1d antigen-loading compartments in human DCs (23). It is possible that oxLDL also participates in this process; therefore, in addition to the induction of CD1d, oxLDL might also modulate the uptake of glycolipid antigens in these cells. Interestingly and in agreement with this model, it was also shown that oxLDL in murine peritoneal macrophage elicits CD1d induction and that CD1d-dependent iNKT activation has a proatherogenic effect (32, 33). These data are consistent with our previous results on PPAR γ -mediated CD1d regulation and with the data presented here.

The transcriptional regulation of CD1d and CD1a appears to be coupled and inverse

We have shown previously that ligand activation of PPAR γ induced CD1d and inhibited CD1a expression. Now by identifying the proximal mechanism we have found that activation of the RAR has an effect similar to that of PPAR γ on CD1a and CD1d expression. These two molecules belong to group 1 (CD1a) and group 2 (CD1d) CD1 proteins. There are emerging lines of evidence to suggest that the timing of their expression, the mode of their regulation, and function may also be different. Group 1 CD1s are not expressed in monocytes and other myeloid precursors but are induced upon DC differentiation. It has also been suggested that myeloid cells such as DCs express group 1 CD1 mRNA and proteins as a result of contact with pathogens such as mycobacteria, TLR agonists, or cytokines (34). In contrast to group 1 CD1 molecules, the expression of CD1d can be increased by

viruses and bacteria and by activators of PPAR γ . It is also intriguing that a single microbial stimulus (i.e., mycobacterial lipids) can oppositely regulate group 1 and group 2 CD1s (34). Our data presented here is very much in line with this scenario and suggests that depending on the actual lipid environment, the activation of either PPAR γ and/or RAR would regulate CD1d and CD1a in opposite directions. This hypothesis is further supported by two additional notions. One is that CD1a and CD1d have distinct functions caused by dissociable and opposite regulation. The second is that certain lipids present in the immune milieu might contribute to changing CD1 expression to arm the cell with the needed CD1 species for presenting lipids the cell become exposed to because of the altered lipid environment (2). Our studies identified lipids such as oxLDL, normal human serum, and retinoids as lipid species regulating CD1 expression. Some of these contain activators or precursors of activators for PPAR γ , RAR, or both. The functional consequence of this is that the presence of PPAR γ -activating lipids or retinoic acid would dictate CD1 expression during DC differentiation, leading to a CD1d-positive and CD1a-negative potentially antiinflammatory cell, or the lack of these lipids and/or the presence of other lipids would promote the differentiation of a CD1a-positive and CD1d-negative cell responding to the attack of infectious agents (i.e., mycobacteria). Thus, the regulated production of retinoic acid appears to be a key mediator of this process and a determinant of CD1 expression in developing DCs. This effect appears to be specific for modifying lipid antigen presentation capacity and has little or no influence on MHC-mediated antigen presentation.

In summary, our findings provide molecular insights into the regulatory logic and the interrelatedness of lipid signaling (retinoid and fatty acid) and lipid antigen presentation. These pathways might also be amenable for therapeutic intervention in inflammatory and immune diseases.

MATERIALS AND METHODS

Ligands. Cells were treated with the following ligands: AM580 (Biomol), rosiglitazone and GW9662, (Alexis Biochemicals), and AGN193109 (a gift from R.A.S. Chandraratna, Allergan Inc., Irvine CA). oxLDL was obtained from Intracel, R115866 was obtained from Janssen, DEAB was obtained from Fluka, and α -GalCer was obtained from Kirin Brewery Ltd. GGC was described previously (23).

Cell culture and ligand treatment. Monocytes (98% CD14⁺) were obtained from Buffy coats by Ficoll gradient centrifugation and magnetic cell separation using anti-CD14-conjugated microbeads (VarioMACS; Miltenyi Biotec). DCs were prepared as described previously (6) with minor modifications. In brief, monocytes were resuspended into six-well culture dishes at a density of 1.5×10^6 cells/ml and cultured in RPMI 1640 (Sigma-Aldrich) supplemented with 10% FBS (Invitrogen) containing 800 U/ml GM-CSF (Peprotech) and 500 U/ml IL-4 (Peprotech). In some experiments, FBS was replaced with human AB serum (Sigma-Aldrich). Cells were cultured for 5 or 6 d, and the IL-4 and GM-CSF addition was repeated at day 3. Ligands or vehicle control (50% DMSO/ethanol) were added to the cell culture starting from the first day or otherwise indicated. AGN193109 administration was always repeated at day 3. To obtain MDCs, DCs were treated with the following mix of cytokines for 24 h: 10 ng/ml TNF- α , 10 ng/ml IL-1 β , 1,000 U/ml IL-6 (Peprotech), and 1 μ g/ml PGE₂ (Sigma-Aldrich).

Peripheral blood myeloid DCs were magnetically isolated with the CD1c (BDCA-1) Dendritic Cell Isolation kit (Miltenyi Biotec) from monocyte-depleted PBMCs. Blood myeloid DCs (10^5 cells/ml) were cultured for 2 d in RPMI 1640 supplemented with 10% FBS.

Immunohistochemistry. Monocytes, DCs, or RSG-treated DCs (6×10^6 cells/group) were pelleted and fixed in 4% paraformaldehyde (pH 7.3) for 24 h at 4°C. Cell blocks were then embedded in paraffin followed by serial sectionings (4 μ m thick). After deparaffinization and dehydration, serial sections from each cell group, mounted on the same glass slides, were used for peroxidase-based indirect IHC. In brief, sections were treated with 3% H₂O₂ in methanol for 15 min at room temperature to block the endogenous peroxidase. For antigen unmasking, sections were heated in antigen-retrieving citrate buffer (pH 6.0; Dako) for 2 min at 120°C using a pressure cooker. IHC stainings were with the standard ABC technique using the primary antibody-specific biotinylated secondary antibodies (Vectastain kits; Vector Laboratories). After blocking the nonspecific binding sites, sections were incubated with the primary antibodies for 1 h at room temperature before using the biotinylated secondary antibodies. The peroxidase-mediated color development was set up for 5 min using the VIP substrate (Vector Laboratories). Finally, the sections were counterstained with methylgreen. The following antibodies were applied: rabbit antibody to RDH10 (13) in a dilution of $\times 1/75$ and goat antibody to ALDH1A1 (RALDH1, ab9883; Abcam) in a dilution of $\times 1/75$.

Western blot analysis. 20 μ g protein whole cell extract was separated by electrophoresis in 12.5% polyacrylamide gel and then transferred to PVDF membrane (Bio-Rad Laboratories). Membranes were probed with anti-RAR α (2ZH1920L; Perseus Proteomics) or anti-RXR α (2ZK8508H; Perseus Proteomics) antibodies, and then the membranes were stripped and reprobed with anti-GAPDH (ab8245-100; Abcam) according to the manufacturer's recommendations.

Mixed leukocyte reaction. MDCs were collected, extensively washed, and used as stimulator cells for allogeneic PBMCs (2×10^5 cells/well). Stimulator cells were added in graded doses to the T cells in 96-well flat-bottom tissue culture plates. Cell proliferation was measured on day 5 by a 16-h pulse with [³H]-thymidine (1 μ Ci/well; BD Biosciences).

FACS analysis. Cell staining was performed using FITC- or PE-conjugated mAbs. Labeled antibodies for flow cytometry included anti-CD1a-PE, anti-CD1d-PE, anti-HLA-DR-PE, and isotype-matched controls (BD Biosciences), anti-V β 11-PE and anti-V α 24-FITC (Immunotech), and anti-HLA-ABC-FITC (W6/32; Abcam). The cells were assessed for fluorescence intensity using EPICS Elite flow cytometer (Beckman Coulter) or with FACS Calibur cytometer (Becton Dickinson).

Expansion of iNKT cells. DCs were treated with 100 ng/ml α -GalCer (or with 100 ng/ml GGC) for 24 h to obtain α -GalCer-loaded DCs. α -GalCer-pulsed DCs (10^5 cells) were cocultured with 10^6 monocyte-depleted autologous PBMCs for 5 d in 24-well plates. The expansion of iNKT cells was monitored by quantifying V α 24⁺ V β 11⁺ cells by FACS analysis.

Human iNKT cell isolation. Monocyte-depleted human PBMCs were incubated with anti-V α 24-FITC (Immunotech) for 20 min at 4°C, cells were washed, anti-mouse immunoglobulin microbeads were added, and immunomagnetic separation was conducted according to the manufacturer's recommendations (VarioMACS; Miltenyi Biotec).

ELISpot for quantifying the activation of iNKT cells. α -GalCer-pulsed DCs (10^4 cells) were cocultured with 10^3 freshly isolated iNKT cells for 16 h in 96-well human INF γ ELISpot plates (R&D Systems). ELISpot plate development was performed according to the manufacturer's recommendations.

Determination of ATRA and retinol concentration. Concentrations of ATRA and retinol were measured in cell pellets by our LC-MS method described in detail previously (14). In brief, 50–100 mg of cell pellet was diluted with a threefold volume of isopropanol, and the extracts were dried in a concentrator (Eppendorf 5301) at 45°C. The dried extracts were resuspended with 60 μ l of methanol, diluted with 40 μ l of 60 mM aqueous ammonium acetate solution, transferred into the autosampler, and subsequently analyzed with an LC-MS system. The LC-MS system consisted of a Waters 2695XE separation module, MS-MS detector (Micromass Quattro micro QAA0029; Waters), including an APCI ionising option (Ion sabre APCI; Waters).

Microarray analysis. Total RNA was isolated using Trizol Reagent (Invitrogen) and further purified by using the RNeasy kit (Qiagen). cRNA was generated from 5 μ g of total RNA by using the SuperScript Choice kit (Invitrogen) and the High Yield RNA transcription labeling kit (Enzo Diagnostics). Fragmented cRNA was hybridized to Affymetrix (Santa Clara) arrays (HU133 Plus 2.0) according to Affymetrix standard protocols. Preliminary data analysis was performed with GCOS software (Affymetrix). Further analysis was performed using GeneSpring 7.2 (Agilent). Microarray data analyses are described in detail in the supplemental Materials and methods.

Real-time quantitative RT-PCR. Total RNA was isolated using TRIZOL reagent (Invitrogen). Reverse transcription was performed at 25°C for 10 min, 42°C for 2 h, and 72°C for 5 min from 100 ng of total RNA using Superscript II reverse transcriptase (Invitrogen) and random primers (3 μ g/ μ l; Invitrogen). Quantitative PCR was performed using real-time PCR (ABI PRISM 7900; Applied Biosystems): 40 cycles at 95°C for 12 s and at 60°C for 30 s using Taqman assays. All PCR reactions were done in triplicates with one control reaction containing no RT enzyme. The comparative Ct method was used to quantify transcripts and normalize to 36B4 or cyclophilin A. Values are expressed as mean \pm SD of the mean. Where indicated significant differences between mean values were evaluated using two-tailed, unpaired Student's t test. In Fig. 2 C, Taqman qPCR low density arrays (TLDA; Applied Biosystems) were used to quantify the expression of RXR and RAR genes in DCs according to the manufacturer's instructions. The sequences of the primers and probes are described in the Table S3 (available at <http://www.jem.org/cgi/content/full/jem.20060141/DC1>).

Online supplemental material. Microarray data analyses are described in detail in the supplemental Materials and methods. Tables S1 and S2 show gene expression data obtained by Affymetrix GeneChip analyses on genes clustered into cluster 3 and 6, respectively. Table S3 contains the sequences of the primers and probes for RT-Q-PCR. Fig. S1 is a comparison of the expression of MHC I and II molecules and T cell activation capacity of retinoid and PPAR γ ligand-activated DCs. Online supplemental material is available at <http://www.jem.org/cgi/content/full/jem.20060141/DC1>.

The authors are grateful to Drs. Zsuzsa Szondy and Dr. Peter J.A. Davies (University of Texas-Houston, Houston, TX) and members of the Nagy laboratory for discussions and comments on the manuscript and Ibolya Furtos for outstanding technical assistance.

The work in the authors' laboratories is supported by grants from the Hungarian National Research Fund (OTKA F038347 to I. Szatmari) and from the National Office for Research and Technology (NKFP 2004 OM-00427 and RET-06/2004 to L. Nagy). G.S. Besra acknowledges support from James Bardrick in the form of a Personal Research Chair. G.S. Besra is a former Lister Institute-Jenner Research Fellow at the Medical Research Council (UK) and The Wellcome Trust (UK). R. Rühl is a Young Researcher of the EU-FP5 Research Training Network "Nutriceptors." L. Nagy is an International Scholar of the Howard Hughes Medical Institute and holds a Wellcome Trust Senior Research Fellowship in Biomedical Sciences in Central Europe.

The authors have no conflicting financial interests.

Submitted: 17 January 2006

Accepted: 24 August 2006

REFERENCES

- Porcelli, S.A., and R.L. Modlin. 1999. The CD1 system: antigen-presenting molecules for T cell recognition of lipids and glycolipids. *Annu. Rev. Immunol.* 17:297–329.
- Moody, D.B. 2006. TLR gateways to CD1 function. *Nat. Immunol.* 7:811–817.
- Calabi, F., J.M. Jarvis, L. Martin, and C. Milstein. 1989. Two classes of CD1 genes. *Eur. J. Immunol.* 19:285–292.
- Kronenberg, M. 2005. Toward an understanding of NKT cell biology: progress and paradoxes. *Annu. Rev. Immunol.* 23:877–900.
- Banchereau, J., and R.M. Steinman. 1998. Dendritic cells and the control of immunity. *Nature.* 392:245–252.
- Szatmari, I., P. Gogolak, J.S. Im, B. Dezso, E. Rajnavolgyi, and L. Nagy. 2004. Activation of PPARgamma specifies a dendritic cell subtype capable of enhanced induction of iNKT cell expansion. *Immunity.* 21:95–106.
- Duester, G. 2000. Families of retinoid dehydrogenases regulating vitamin A function: production of visual pigment and retinoic acid. *Eur. J. Biochem.* 267:4315–4324.
- Napoli, J.L. 1996. Biochemical pathways of retinoid transport, metabolism, and signal transduction. *Clin. Immunol. Immunopathol.* 80: S52–S62.
- Geissmann, F., P. Revy, N. Brousse, Y. Lepelletier, C. Folli, A. Durandy, P. Chambon, and M. Dy. 2003. Retinoids regulate survival and antigen presentation by immature dendritic cells. *J. Exp. Med.* 198:623–634.
- Iwata, M., A. Hirakiyama, Y. Eshima, H. Kagechika, C. Kato, and S.Y. Song. 2004. Retinoic acid imprints gut-homing specificity on T cells. *Immunity.* 21:527–538.
- Haeseleer, F., J. Huang, L. Lebioda, J.C. Saari, and K. Palczewski. 1998. Molecular characterization of a novel short-chain dehydrogenase/reductase that reduces all-trans-retinal. *J. Biol. Chem.* 273:21790–21799.
- Jette, C., P.W. Peterson, I.T. Sandoval, E.J. Manos, E. Hadley, C.M. Ireland, and D.A. Jones. 2004. The tumor suppressor adenomatous polyposis coli and caudal related homeodomain protein regulate expression of retinol dehydrogenase L. *J. Biol. Chem.* 279:34397–34405.
- Wu, B.X., Y. Chen, J. Fan, B. Rohrer, R.K. Crouch, and J.X. Ma. 2002. Cloning and characterization of a novel all-trans retinol short-chain dehydrogenase/reductase from the RPE. *Invest. Ophthalmol. Vis. Sci.* 43:3365–3372.
- Ruhl, R. 2006. Method to determine 4-oxo-retinoic acids, retinoic acids and retinol in serum and cell extracts by liquid chromatography/diode-array detection atmospheric pressure chemical ionisation tandem mass spectrometry. *Rapid Commun. Mass Spectrom.* 20:2497–2504.
- Chambon, P. 1996. A decade of molecular biology of retinoic acid receptors. *FASEB J.* 10:940–954.
- Chiocca, E.A., P.J. Davies, and J.P. Stein. 1988. The molecular basis of retinoic acid action. Transcriptional regulation of tissue transglutaminase gene expression in macrophages. *J. Biol. Chem.* 263:11584–11589.
- Cerignoli, F., X. Guo, B. Cardinali, C. Rinaldi, J. Casaletto, L. Frati, I. Screpanti, L.J. Gudas, A. Gulino, C.J. Thiele, and G. Giannini. 2002. retSDR1, a short-chain retinol dehydrogenase/reductase, is retinoic acid-inducible and frequently deleted in human neuroblastoma cell lines. *Cancer Res.* 62:1196–1204.
- Szanto, A., S. Benko, I. Szatmari, B.L. Balint, I. Furtos, R. Ruhl, S. Molnar, L. Csiba, R. Garuti, S. Calandra, et al. 2004. Transcriptional regulation of human CYP27 integrates retinoid, peroxisome proliferator-activated receptor, and liver X receptor signaling in macrophages. *Mol. Cell. Biol.* 24:8154–8166.
- Russo, J.E., D. Haugwitz, and J. Hilton. 1988. Inhibition of mouse cytosolic aldehyde dehydrogenase by 4-(diethylamino)benzaldehyde. *Biochem. Pharmacol.* 37:1639–1642.
- Stoppie, P., M. Borgers, P. Borghgraef, L. Dillen, J. Goossens, G. Sanz, H. Szel, C. Van Hove, G. Van Nyen, G. Nobels, et al. 2000. R115866 inhibits all-trans-retinoic acid metabolism and exerts retinoidal effects in rodents. *J. Pharmacol. Exp. Ther.* 293:304–312.
- Nencioni, A., F. Grunebach, A. Zobywlski, C. Denzlinger, W. Brugger, and P. Brossart. 2002. Dendritic cell immunogenicity is regulated by peroxisome proliferator-activated receptor gamma. *J. Immunol.* 169:1228–1235.
- Kawano, T., J. Cui, Y. Koezuka, I. Toura, Y. Kaneko, K. Motoki, H. Ueno, R. Nakagawa, H. Sato, E. Kondo, et al. 1997. CD1d-restricted and TCR-mediated activation of valpha14 NKT cells by glycosylceramides. *Science.* 278:1626–1629.
- van den Elzen, P., S. Garg, L. Leon, M. Brigl, E.A. Leadbetter, J.E. Gumperz, C.C. Dascher, T.Y. Cheng, F.M. Sacks, P.A. Illarionov, et al. 2005. Apolipoprotein-mediated pathways of lipid antigen presentation. *Nature.* 437:906–910.
- Villadangos, J.A., P. Schnorrer, and N.S. Wilson. 2005. Control of MHC class II antigen presentation in dendritic cells: a balance between creative and destructive forces. *Immunol. Rev.* 207:191–205.
- Mohty, M., S. Morbelli, D. Isnardon, D. Sainty, C. Arnoulet, B. Gaugler, and D. Olive. 2003. All-trans retinoic acid skews monocyte differentiation into interleukin-12-secreting dendritic-like cells. *Br. J. Haematol.* 122:829–836.
- Nagy, L., P. Tontonoz, J.G. Alvarez, H. Chen, and R.M. Evans. 1998. Oxidized LDL regulates macrophage gene expression through ligand activation of PPARgamma. *Cell.* 93:229–240.
- Wako, Y., K. Suzuki, Y. Goto, and S. Kimura. 1986. Vitamin A transport in plasma of diabetic patients. *Tohoku J. Exp. Med.* 149:133–143.
- Krasinski, S.D., J.S. Cohn, R.M. Russell, and E.J. Schaefer. 1990. Postprandial plasma vitamin A metabolism in humans: a reassessment of the use of plasma retinyl esters as markers for intestinally derived chylomicrons and their remnants. *Metabolism.* 39:357–365.
- Garbe, A., J. Buck, and U. Hammerling. 1992. Retinoids are important cofactors in T cell activation. *J. Exp. Med.* 176:109–117.
- Colgan, S.P., R.M. Hershberg, G.T. Furuta, and R.S. Blumberg. 1999. Ligation of intestinal epithelial CD1d induces bioactive IL-10: critical role of the cytoplasmic tail in autocrine signaling. *Proc. Natl. Acad. Sci. USA.* 96:13938–13943.
- Rimoldi, M., M. Chieppa, V. Salucci, F. Avogadri, A. Sonzogni, G.M. Sampietro, A. Nespoli, G. Viale, P. Allavena, and M. Rescigno. 2005. Intestinal immune homeostasis is regulated by the crosstalk between epithelial cells and dendritic cells. *Nat. Immunol.* 6:507–514.
- Nakai, Y., K. Iwabuchi, S. Fujii, N. Ishimori, N. Dashtoodol, K. Watano, T. Mishima, C. Iwabuchi, S. Tanaka, J.S. Bezbradica, et al. 2004. Natural killer T cells accelerate atherosclerosis in mice. *Blood.* 104:2051–2059.
- Tupin, E., A. Nicoletti, R. Elhage, M. Rudling, H.G. Ljunggren, G.K. Hansson, and G.P. Berne. 2004. CD1d-dependent activation of NKT cells aggravates atherosclerosis. *J. Exp. Med.* 199:417–422.
- Roura-Mir, C., L. Wang, T.Y. Cheng, I. Matsunaga, C.C. Dascher, S.L. Peng, M.J. Fenton, C. Kirschning, and D.B. Moody. 2005. Mycobacterium tuberculosis regulates CD1 antigen presentation pathways through TLR-2. *J. Immunol.* 175:1758–1766.