









**ORIGINAL RESEARCH**

# Effect of Acute Exposure to Altitude on the Quality of Chest Compression-Only Cardiopulmonary Resuscitation in Helicopter Emergency Medical Services Personnel: A Randomized, Controlled, Single-Blind Crossover Trial

Anna Vögele , MD;\* Michiel Jan van Veelen , MD;\* Tomas Dal Cappello , MSc; Marika Falla , MD, PhD; Giada Nicoletto, MD; Alexander Dejaco , MD, PhD; Martin Palma , MSc; Katharina Hühner , MD; Hermann Brugger , MD; Giacomo Strapazzon , MD, PhD

**BACKGROUND:** Helicopter emergency medical services personnel operating in mountainous terrain are frequently exposed to rapid ascents and provide cardiopulmonary resuscitation (CPR) in the field. The aim of the present trial was to investigate the quality of chest compression only (CCO)-CPR after acute exposure to altitude under repeatable and standardized conditions.

**METHODS AND RESULTS:** Forty-eight helicopter emergency medical services personnel were divided into 12 groups of 4 participants; each group was assigned to perform 5 minutes of CCO-CPR on manikins at 2 of 3 altitudes in a randomized controlled single-blind crossover design (200, 3000, and 5000 m) in a hypobaric chamber. Physiological parameters were continuously monitored; participants rated their performance and effort on visual analog scales. Generalized estimating equations were performed for variables of CPR quality (depth, rate, recoil, and effective chest compressions) and effects of time, altitude, carryover, altitude sequence, sex, qualification, weight, preacclimatization, and interactions were analyzed. Our trial showed a time-dependent decrease in chest compression depth ( $P=0.036$ ) after 20 minutes at altitude; chest compression depth was below the recommended minimum of 50 mm after 60 to 90 seconds (49 [95% CI, 46–52] mm) of CCO-CPR.

**CONCLUSIONS:** This trial showed a time-dependent decrease in CCO-CPR quality provided by helicopter emergency medical services personnel during acute exposure to altitude, which was not perceived by the providers. Our findings suggest a reevaluation of the CPR guidelines for providers practicing at altitudes of 3000 m and higher. Mechanical CPR devices could be of help in overcoming CCO-CPR quality decrease in helicopter emergency medical services missions.

**REGISTRATION:** URL: <https://www.clinicaltrials.gov>; Unique identifier: NCT04138446.

**Key Words:** cardiac arrest ■ chest compression ■ helicopter emergency medical services ■ hypobaric hypoxia ■ resuscitation

**S**udden cardiac arrest is the most common cause of all nontraumatic deaths during activities at moderate and high altitude.<sup>1</sup> Recreational and

other outdoor activities at altitude are increasing also among people with risk factors for sudden cardiac arrest, like hypertension, history of coronary heart

Correspondence to: Giacomo Strapazzon, MD, PhD, Viale Druso 1, 39100 Bolzano, Italy. E-mail: [giacomo.strapazzon@eurac.edu](mailto:giacomo.strapazzon@eurac.edu)

\*A. Vögele and M. J. van Veelen contributed equally.

Supplementary Material for this article is available at <https://www.ahajournals.org/doi/suppl/10.1161/JAHA.121.021090>

For Sources of Funding and Disclosures, see page 9.

© 2021 The Authors. Published on behalf of the American Heart Association, Inc., by Wiley. This is an open access article under the terms of the Creative Commons Attribution-NonCommercial-NoDerivs License, which permits use and distribution in any medium, provided the original work is properly cited, the use is non-commercial and no modifications or adaptations are made.

JAHA is available at: [www.ahajournals.org/journal/jaha](http://www.ahajournals.org/journal/jaha)

## CLINICAL PERSPECTIVE

### What Is New?

- We found a time-dependent decrease in chest compression quality provided by helicopter emergency medical services personnel after rapid ascent (20 minutes) to altitude (3000 and 5000 m).
- This loss of quality was not perceived by the providers.

### What Are the Clinical Implications?

- We suggest reevaluation of cardiopulmonary resuscitation guidelines for providers practicing at altitudes of 3000 m and higher, considering a shorter chest compression cycle or the use of a mechanical cardiopulmonary resuscitation device.

## Nonstandard Abbreviations and Acronyms

<b>CC</b>	chest compressions
<b>CCO-CPR</b>	chest compression only-cardiopulmonary resuscitation
<b>GEE</b>	generalized estimating equations
<b>HEMS</b>	helicopter emergency medical services
<b>HH</b>	hypobaric hypoxia
<b>HR</b>	heart rate
<b>SpO<sub>2</sub></b>	oxygen saturation

disease, or previous myocardial infarction.<sup>2-4</sup> Activities at altitude result in exposure to several stressors such as hypobaric hypoxia (HH), cold temperature, and physical exhaustion. These factors may increase the risk of sudden cardiac arrest in mountainous and remote areas.<sup>5</sup>

Rapid recognition of sudden cardiac arrest and early high-quality cardiopulmonary resuscitation (CPR) combined with electrical defibrillation is crucial for survival.<sup>6</sup> Helicopter emergency medical services (HEMS) allow the earliest arrival of advanced life support teams in mountainous or rural areas.<sup>7</sup> HEMS personnel operating in mountainous areas are acutely exposed to HH because of the rapid helicopter ascent to altitude.<sup>8</sup> Acute HH exposure leads to physiological short-term responses involving the cardiovascular and the respiratory systems, like the increase in heart rate (HR), cardiac output, blood pressure, and respiratory rate.<sup>9,10</sup> Physiological parameters and resuscitation performance of study participants following a stay at altitude have been described previously.<sup>11,12</sup> An experimental

study recorded a decrease in oxygen saturation (SpO<sub>2</sub>) and an increase in HR and fatigue during chest compressions (CCs) at a simulated altitude of about 3700 m.<sup>11</sup> Similar physiological responses and a decrease in CC depth and proportion of effective CC were recorded after 6-hour exposure to an altitude of 3100 m in a field study.<sup>12</sup> However, the effect of a rapid exposure to high altitude by immediate helicopter ascent on physiological parameters and resuscitation performance is less well studied.

In our trial we investigated the factors affecting the quality of HEMS personnel's CCO-CPR (regarding compression depth, rate, correct position of the hands on the chest, and recoil, ie, full rebound after each compression) after acute exposure to different altitude levels (200 versus 3000 versus 5000 m) under repeatable, blinded, and standardized conditions. The results could help to develop evidence-based recommendations for resuscitation during HEMS missions in mountain areas up to 5000 m worldwide.

## METHODS

The study was designed as a randomized, controlled, single-blinded crossover trial and ran from October 25 to November 11, 2019 at terraXcube, Eurac Research, Bolzano, Italy. It was conducted and reported according to the Declaration of Helsinki and the Consolidated Standards of Reporting Trials guidelines.<sup>13</sup> The Ethics Committee review board of Bolzano, Italy, has approved the study (protocol number 0122265-BZ), and it is registered on ClinicalTrials.gov (Identifier: NCT04138446). All participants gave written informed consent to participate. The data that support the findings of this study are available from the corresponding author upon reasonable request.

### Study Participants

Study participants were recruited from helicopter emergency services personnel in Austria, Germany, Italy, and Switzerland. Inclusion criteria were age between 18 and 60 years, written informed consent, and an American Society of Anesthesiologists Physical Status Classification System class I.<sup>14</sup> Participants between 40 and 60 years or below 40 years with cardiovascular risk factors, according to the European Society of Cardiology guidelines, were screened with a cardiovascular stress test.<sup>15</sup> Exclusion criteria were age over 60 years, an American Society of Anesthesiologists Physical Status Classification System > class I and a medical history of severe altitude illness.

### Randomization and Blinding

Participants were divided into 12 groups of 4 people. Altitude profiles were randomly assigned to the 12

groups. The crossover consisted of 6 study arms—1 for each altitude profile—as shown in Figure 1. Every altitude profile was applied to a total of 8 participants, that is, 2 groups. Participants and research personnel were blinded toward the altitude profiles, except for the principal investigator and chamber operator for operational and safety reasons. Ascent and descent times to the 3 different altitudes were standardized to 20 minutes for optimal blinding. The sham ascent consisted of an oscillating ascent-descent to evoke pressure change on the eardrums.

## Study Protocol

The study was done in a research infrastructure able to create a condition of HH (terraXcube, Eurac Research, Bolzano, Italy, <https://terraxcube.eurac.edu>), see Figure 1. The participants were exposed to 2 of the 3 simulated altitudes each (Figure 2). Other parameters such as temperature, humidity, and CO<sub>2</sub> levels were kept constant at typical indoor climate values (20–22 °C, 30%–50%, and up to 1100 ppm, respectively). The chamber ascent and descent rates were set at 4 m/s, which corresponds to typical helicopter ascent rate.<sup>8</sup>

On day 0 medical history of the participants was taken and each participant underwent a physical examination, including cardiovascular, pulmonary and ear, nose, and throat assessment. After filling out a questionnaire about exposures above 3000 m in the 3 months before the study, participants were assigned to 3 preacclimatization groups according to the total hours of exposure, that is, (1) not preacclimatized for 0 to 4 hours exposure, (2) partially preacclimatized for 5 to 24 hours during multiple exposure, and (3)

preacclimatized for >24 hours exposure, overnight stays, high-frequency exposure (>10 times), or altitude >4000 m and exposure within the 3 weeks before study dates. The participants received a CPR refresher training focusing on CCO-CPR to ensure equal baseline levels according to the international guidelines for resuscitation (American Heart Association and European Resuscitation Council).<sup>6,16</sup>

On day 1 and day 2, each group (n=4) was exposed to 1 of the altitudes. After the ascent, the participants were given 20 minutes of rest before initiating 5 minutes of CCO-CPR on manikins (Laerdal Resusci Anne QCPR, Stavanger, Norway, fitted with standard compression spring) connected to a tablet for data recording (Laerdal SimPad PLUS, Stavanger, Norway) without feedback. After compressions, participants rated their performance and subjective effort using 2 visual analog scales (VAS). The VAS was a 100 mm horizontal line between 2 extremes (good and bad performance and high and low effort). Two-lead ECG, HR, respiratory rate, and SpO<sub>2</sub> were continuously monitored by an integrated wearable monitoring system (Equival EQ02, Hidalgo, Cambridge, UK) collecting data at 4 timepoints, that is, before altitude exposure, at altitude both before and after CCO-CPR, and after descent.

## Statistical Analysis

CCO-CPR performance was recorded in terms of CC depth, rate, and recoil, where compressions with a depth of >50 mm at the correct position of the hands (midchest) were declared as effective. Criteria for adequate depth and rate of CCs were 50 to 60 mm and 100 to 120/minute according to international

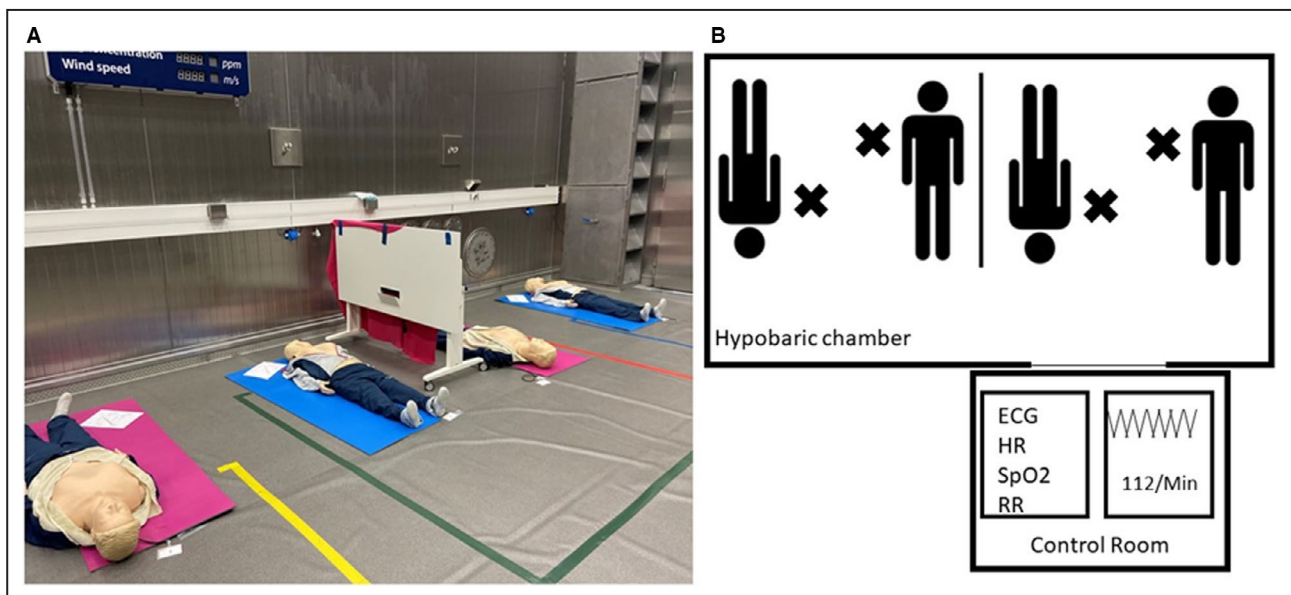

**Figure 1.** Setup of manikins and walking routes in the hypobaric chamber (A) and scheme of the hypobaric chamber and of the control room with the main physiological parameters monitored (B). HR, heart rate; RR, respiratory rate; and SpO<sub>2</sub>, oxygen saturation.

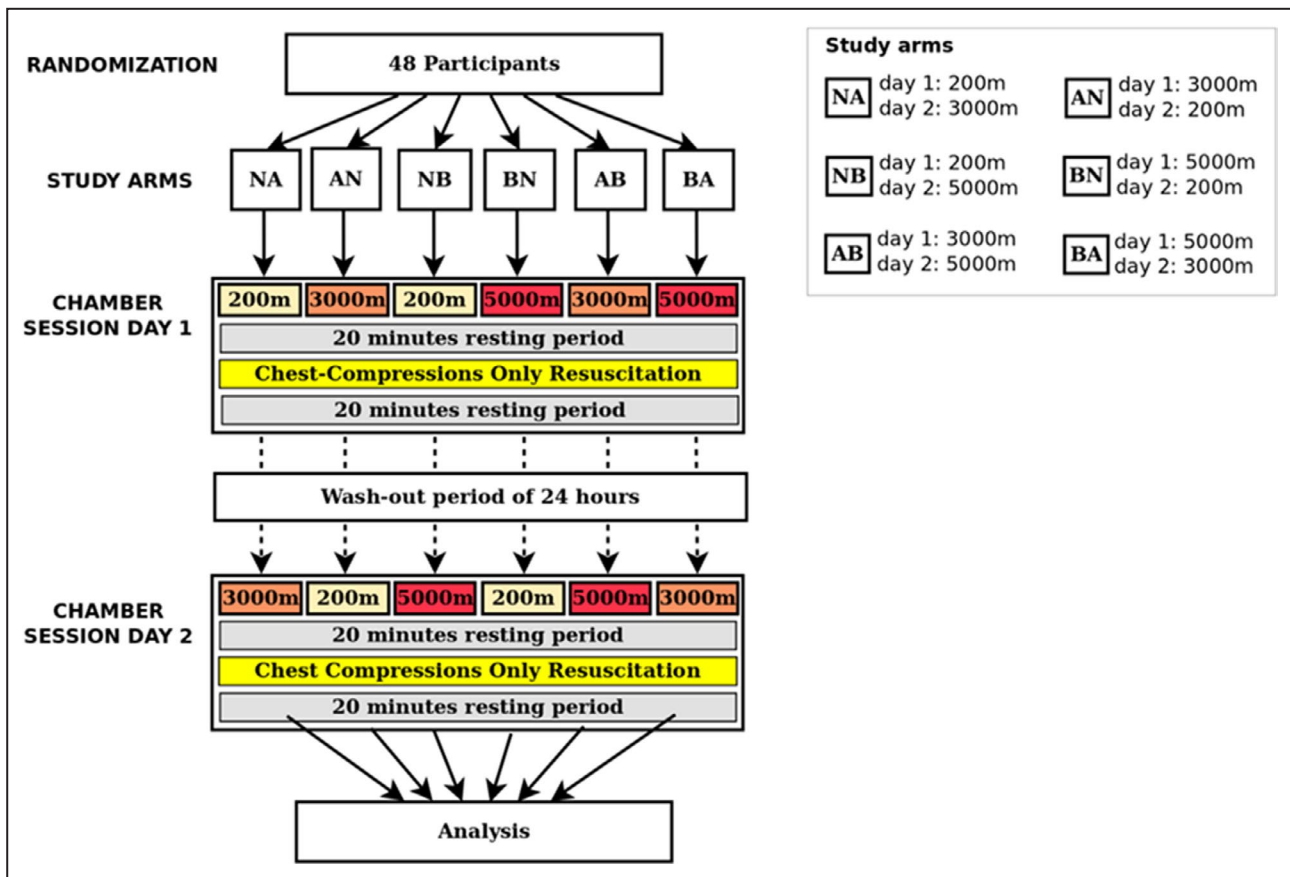

**Figure 2.** Study design.

guidelines (American Heart Association and European Resuscitation Council).<sup>6,16</sup> For the statistical analysis, each 5-minute continuous CCO-CPR was divided into ten 30-second periods and the average of CC depth, rate, and recoil and the absolute number of effective compressions per period were considered as dependent variables. Generalized estimating equations (GEE) were performed for each dependent variable to consider repeated measures of each participant and analyze whether the following factors had an effect: timepoint (10 levels from 0–30 to 270–300 seconds representing the ten 30-second periods), altitude, carryover effect of the altitude of the first day of test on the second day (4 levels: day 1, day 2 after a test at 200 m on day 1, day 2 after a test at 3000 m on day 1, day 2 after a test at 5000 m on day 1), altitude sequence (6 arms, see Figure 2), sex, qualification as a health care provider, weight (2 groups, considering the median weight of 70 kg as cutoff), preacclimatization, and interactions of altitude with sex, timepoint with sex, altitude with weight, timepoint with weight, and timepoint with altitude. The distributions of the dependent variables of the GEE were determined by means

of normal probability plots, analyzing departures from normality and considering if the probability distribution was either discrete or continuous. For CC depth, rate, and recoil, the normal distribution and identity as link function were specified. Because some participants reported timepoints with zero effective CCs and the effective CCs could be considered as count data, for the number of effective compressions the Poisson distribution and the logarithm as link function were specified. The selection of the variables was carried out by means of backward elimination using the Corrected Quasi Likelihood under Independence Model Criterion. For each factor, *P* values were corrected by using the Holm-Bonferroni method. GEE were also performed to evaluate the effect of altitude and 4 timepoints (before altitude exposure, at altitude before CCO-CPR, at altitude after CCO-CPR, after descent) on HR, respiratory rate, and SpO<sub>2</sub> using the normal distribution and identity as link function. Comparisons of participants' baseline characteristics between different qualifications of HEMS crew (ie, health care providers or other crew members) were carried out for clinical reasons and were performed by Student's *t* test, Fisher's exact

test, and Pearson's chi-square test, as appropriate. As VAS performance and VAS effort showed a right-skewed distribution, GEE with gamma distribution and logarithm as link function were performed to evaluate the effect of altitude on them. Pearson correlation was used to correlate VAS performance and VAS effort with mean CC depth, rate, recoil, and the total number of effective compressions. SPSS version 25 (IBM Corp., Armonk, NY, USA) was used for the statistical analysis, and  $P < 0.05$  (2 sided) was considered statistically significant. Values are reported as mean $\pm$ SD, except frequencies as percentages and estimates of the GEE as mean (95% CI).

## RESULTS

Forty-nine volunteers were consecutively recruited and 48 met the inclusion criteria for this trial; 1 was excluded for medical reasons. Participants had a mean age of 40 $\pm$ 9 years and 77% were male; 19% of the participants were preacclimatized, 27% partially preacclimatized, and 54% were not preacclimatized (Table 1). Of these participants 52% were health care providers; all participants were basic life support providers, of whom 46% were certified advanced life support providers (Table 1). None of the participants dropped out, all participants completed the 5-minute CCO-CPR at their assigned blinded altitude, and no health issues related to altitude were reported.

The recorded vital signs of the participants at the different altitudes before and after exposure to altitude, pre- and post-CCO-CPR are shown in Table 2. HR increased at altitude and SpO<sub>2</sub> decreased ( $P < 0.001$  for all pairwise comparisons).

Table 3 shows all the measured variables and their influence on CC quality. There was an independent effect of the duration of ongoing CCO-CPR on depth, rate, and number of effective CCs ( $P < 0.001$

for all). Depth decreased and rate changed over time at high altitude, see Figure 3 and Table 3. During the first 90 seconds, the decrease of CC depth was more pronounced at altitude (3000 and 5000 m) than at 200 m ( $P = 0.036$ ). After 60 to 90 seconds of CCs at altitude the estimated means of the depth started to be lower than the guideline's limits (49 [95% CI, 46–52] mm), although the upper limit of the 95% CI was lower only twice (during the last 90 seconds for 3000 m). At 200 m the estimated mean was below limits only during the last 30 seconds (49 [95% CI, 44–55] mm) (Figure 3). The estimated means of compression rate were always within the guideline's limits, and only the upper limits of the 95% CI exceeded the guideline's limit of 120/minute during the first 60 seconds and the last 90 seconds (Figure 3). An independent positive effect of a higher participant weight was detected for both CC depth and number of CCs. The estimated means showed deeper compressions for participants with a weight  $\geq 70$  kg (52 [95% CI, 50–55] mm) than for participants with a weight  $< 70$  kg (46 [95% CI, 44–49] mm,  $P = 0.004$ ), below the guideline's lower limit of 50 mm. The mean number of effective compressions per timepoint was higher in participants with a weight  $\geq 70$  kg (26 [95% CI, 15–44] versus 16 [95% CI, 10–27],  $P = 0.026$ ). There was neither a single nor a combined effect of sex with altitude on variables related to CCO-CPR quality. Depth, rate, and number of effective CCs showed a different course for men and women (Figure S1). The estimated means of CC depth showed in women a faster decrease than in men, especially during the first 90 seconds ( $P = 0.036$ ). No carryover effect of altitude exposure effect was detected between day 1 and 2, along with no effect of altitude sequence of the 2 tests, qualification and preacclimatization (Table 3).

Participants rated subjective performance on a VAS scale lower at 200 m (0.23 $\pm$ 0.14) and 3000 m

**Table 1. Baseline Characteristics of Study Participants (N=48)**

Parameter	HEMS health care providers (Medical doctors, nurses, paramedics)	Other HEMS crew members (Technicians, pilots, rescuers)	Total	Health care providers vs other, <i>P</i> value
Total, n	25	23	48	...
Female sex, n (%)	10 (40.0)	1 (4.3)	11 (22.9)	0.005*
Age, y, mean $\pm$ SD	38.2 $\pm$ 8.5	41.6 $\pm$ 8.9	39.8 $\pm$ 8.8	0.173
Weight, kg, mean $\pm$ SD	69.4 $\pm$ 12.6	73.2 $\pm$ 12.1	71.2 $\pm$ 12.4	0.291
Height, cm, mean $\pm$ SD	174 $\pm$ 9	177 $\pm$ 7	176 $\pm$ 8	0.298
Body mass index, kg/m <sup>2</sup> , mean $\pm$ SD	23 $\pm$ 3	23 $\pm$ 3	23 $\pm$ 3	0.441
Advanced life support providers, n (%)	21 (84.0)	1 (4.3)	22 (45.8)	<0.001*
Preacclimatized/partially preacclimatized/not preacclimatized, n (%)	4 (16.0)/6 (24.0)/15 (60.0)	5 (21.7)/7 (30.4)/11 (47.8)	9 (18.8)/13 (27.1)/26 (54.2)	0.697

Tests performed were Student *t* tests; except for comparison of female and advanced life support provider proportions Fisher's exact tests and for comparison of levels of preacclimatization Pearson's chi-square test. HEMS indicates Helicopter Emergency Medical Services.

\* $P < 0.05$ .

**Table 2. Vital Signs Before Exposure to Altitude, Pre- and Post-CCO-CPR and After Exposure to Altitude**

Parameter	Altitude	Timepoint				Altitude effect, <i>P</i> value	Timepoint effect, <i>P</i> value
		Before altitude exposure	At altitude, pre-CCO-CPR	At altitude, post-CCO-CPR	After altitude exposure		
Heart rate, bpm	200 m	71±12	68±11	117±21	68±11	<0.001*	<0.001*
	3000 m	71±13	70±13	117±23	69±12		
	5000 m	72±12	80±14	134±22	70±12		
Respiratory rate, rpm	200 m	15±4	14±4	29±8	14±3	0.079	<0.001*
	3000 m	15±4	12±3	27±7	14±4		
	5000 m	15±3	12±3	30±11	14±4		
Oxygen saturation, %	200 m	99±1	98±1	96±3	98±1	<0.001*	<0.001*
	3000 m	99±1	93±3	91±4	99±1		
	5000 m	98±1	78±5	78±4	98±1		

bpm indicates beat per minute; CCO-CPR, chest compression-only cardiopulmonary resuscitation; rpm, rate per minute.

*P* values are calculated by means of generalized estimating equations (GEE) and adjusted with Holm-Bonferroni method.

\**P*<0.05.

(0.26±0.20) in comparison to 5000 m (0.37±0.20; *P*<0.001 for 200 versus 5000 m and *P*=0.003 for 3000 versus 5000 m). The subjective effort on a VAS scale was rated lower at 200 m (0.39±0.23) and 3000 m (0.38±0.28) than at 5000 m (0.55±0.19; *P*=0.002 for 200 versus 5000 m and *P*=0.009 for 3000 versus 5000 m). VAS performance and VAS effort were not correlated with the objective measures of performance (all *P*>0.05, Table S1) such as the mean CC depth, rate, and recoil and the total number of effective CCs.

## DISCUSSION

This randomized controlled trial investigates the effect of acute exposure of HEMS personnel to altitude (3000 and 5000 m) on the quality of CCO-CPR under repeatable, blind, and standardized conditions. Our study showed a time-dependent decrease in CC depth which could be below the recommended minimum of 50 mm at both altitudes after 60 to 90 seconds. The loss in quality was not perceived by the providers.

Our results suggest that the acute exposure to HH is related to an impairment of the ability of HEMS providers to adhere to resuscitation guidelines starting after 60 to 90 seconds of CCO-CPR initiation. There is a significant risk that the depth of CCs can drop below the recommended 50 mm already before 2 minutes, when switching the CC provider is recommended by international CPR guidelines. Noncompliance to the lower limits set for the depth could lead to a worse clinical outcome.<sup>17,18</sup> Frequent switching of providers is indicated when signs of fatigue appear. Even though the effort was perceived higher at 5000 m, there was no correlation between altitude and the ability to self-assess whether the quality of CCs was adequate. This indicates that a change in CCO-CPR performance could not be detectable subjectively and, therefore,

provider perception cannot indicate in a reliable way when an early changeover is required to maintain adequate CC quality.

SpO<sub>2</sub> was significantly lower already after 20 minutes at both studied altitudes than before and after exposure to altitude at ground level. Such decrease could progressively contribute to the deterioration of performance during CPR. CCO-CPR performance at altitude was optimal only at initiation, but during CC there was a decrease in depth and an overall decrease in the number of effective CCs per minute. An experimental field study also showed that the quality of CCO-CPR (ie, average CC depth and the number of effective CCs) after an exposure to an altitude of 3100 m of 6 hours decreased after 1 minute of compressions compared with sea level.<sup>12</sup> During compressions they observed a significant decrease in SpO<sub>2</sub> and an increase in systolic and diastolic blood pressure, HR, and fatigue. Similarly, an experimental HH study showed that during CCO-CPR at 3700 m equivalent barometric pressure the study participants' SpO<sub>2</sub> significantly decreased, and HR and fatigue increased,<sup>11</sup> but they did not report on CPR quality.

Previous studies have described a deterioration of the quality of CCO-CPR at sea level after 1 minute.<sup>19,20</sup> When comparing CCO-CPR with conventional CPR with ventilation, the quality of the compressions started to deteriorate after 30 seconds and reached statistical significance at 61 to 82 seconds.<sup>20</sup> The guidelines recommend that CPR providers change over about every 2 minutes to prevent a decrease in compression quality due to provider fatigue.<sup>6</sup> Our findings suggest that the CC depth of minimum 50 mm during CCO-CPR of HEMS personnel after rapid exposure to altitude between 3000 and 5000 m is achieved only at initiation and thereafter there is a risk of impairment, which is more pronounced in female providers and

**Table 3. P Values of the Factors Resulting From the Generalized Estimating Equations Performed on Each Dependent Variable**

Dependent variable	Intercept	Timepoint	Altitude	Carryover	Sequence	Sex	Qualification	Weight	Pre-acclimatization	Timepoint* altitude	Altitude* sex	Timepoint* sex	Altitude* weight	Timepoint* weight
Depth	<0.001 <sup>†</sup>	<0.001 <sup>†</sup>	1.000	1.000	0.331	0.126	1.000	0.004 <sup>†</sup>	1.000	0.036 <sup>†</sup>	1.000	0.036 <sup>†</sup>	0.887	1.000
Rate	<0.001 <sup>†</sup>	<0.001 <sup>†</sup>	1.000	0.144	0.428	1.000	0.371	0.763	1.000	0.001 <sup>†</sup>	1.000	<0.001 <sup>†</sup>	1.000	1.000
Effective chest compressions	<0.001 <sup>†</sup>	<0.001 <sup>†</sup>	1.000	1.000	0.910	0.151	1.000	0.026 <sup>†</sup>	1.000	0.262	0.326	<0.001 <sup>†</sup>	0.422	1.000
Recoil	<0.001 <sup>†</sup>	0.078	1.000	1.000	1.000	0.946	0.763	0.394	1.000	0.764	1.000	0.169	1.000	1.000

CC indicates chest compression.

\*An asterisk between 2 factors denotes interaction of the 2 factors. The P values are corrected by means of the Holm-Bonferroni method.

<sup>†</sup>P<0.05.

providers <70 kg of weight. Our finding highlights the need to raise awareness in providers on a potential decline of their CC performance over time at altitude. It also raises the question of whether the recommended 2-minute cycle should be applied to providers subject to rapid exposure to moderate and high altitudes such as HEMS personnel.

Inability to self-estimate adequate quality of CCs has been identified in earlier studies assessing compression quality of CCO-CPR.<sup>19,21</sup> Subjective CCO-CPR performance on a VAS scale in our study was not correlated with CCO-CPR quality. Other studies performed at sea level also showed that self-assessment of fatigue and a decline in CPR quality did not match.<sup>19,20</sup> These findings contradict previous studies performed at altitude where a decrease in performance and increase in fatigue were noticed by study participants.<sup>11,12</sup> Compared with the previous studies at altitude, our trial is the first in which participants were blinded to the altitude, avoiding possible bias. The inability to perceive insufficient performance might lead HEMS personnel to deliver inadequate compressions. Despite that switching to a shorter compression cycle with frequent changeovers at altitude could lead to more effective CCs overall, and potentially a better-quality CPR, there is the risk to induce additional short intervals of not delivering compressions during each changeover. Moreover, in settings like HEMS where there is often both limited spaces to maneuver and limited providers available, more frequent changeovers will not be possible. Mechanical CPR devices achieve similar resuscitation quality compared with high-quality manual delivery of CCs,<sup>22</sup> and the availability of these devices might be especially relevant for management of cardiac arrest during HEMS operations at high altitude. Advantages could be that mechanical CPR devices can deliver continuous compressions without degradation of quality even in prolonged resuscitation and without need for provider changeover, especially during transport and transfer, where manual CC might not be feasible or possible at all.<sup>23–25</sup> Disadvantages are training needed to fit the device correctly on the patient and the dependency on battery power outside of the helicopter, which is compromised in cold environments frequently encountered by HEMS crews operating at altitude. Supplementary oxygen for providers could be used to counteract the physiological effect of acute hypoxia, although logistically challenging as providers are mobile and making transfers in and out of the helicopter. Further studies assessing the performance of providers receiving supplementary oxygen at altitude are needed to prove the efficacy and feasibility of this option.

Studies describing differences of CCO-CPR quality between sex and weight showed contradictory findings. An earlier study investigating CPR quality during

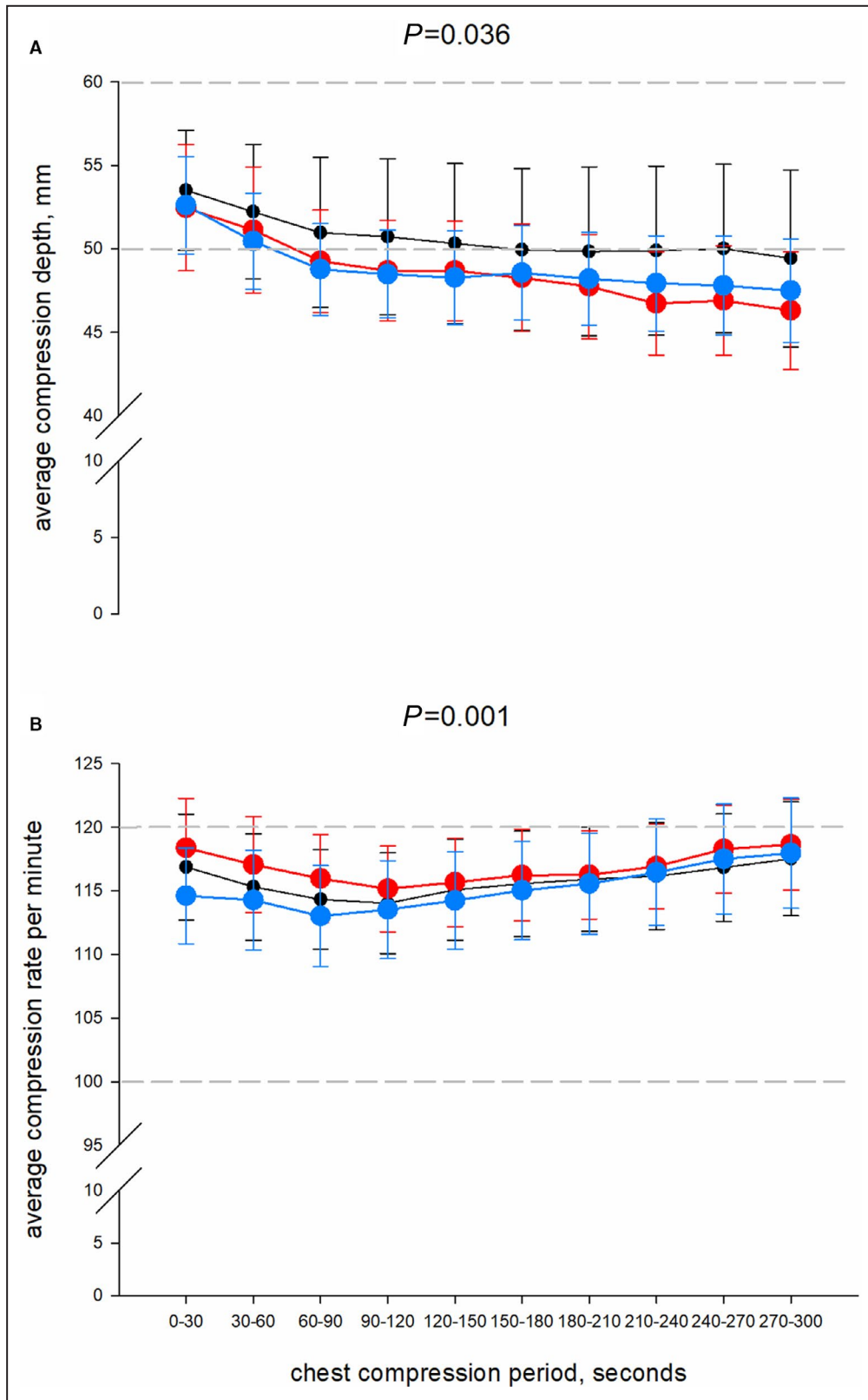

**Figure 3.** Interaction effect of timepoint (represented by the 30-second period) with altitude on depth (A) and rate (B) of chest compressions. Black circles represent estimated means by generalized estimating equations for 200 m, red circles for 3000 m, and blue circles for 5000 m. Grey dashed lines indicate the guidelines' limits and error bars represent 95% CI of the estimated mean.



CCO-CPR at sea level found no difference in the quality of CCs delivered in relation to sex or weight.<sup>18</sup> However, another study recorded a significantly lower performance in female and lower body weight providers in CCO-CPR.<sup>26</sup> In our study population the quality of CCO-CPR was significantly decreased in the subgroups of participants with a body weight <70 kg and female participants. Higher body weight and muscle strength might enable the delivery of adequate CCs for a longer time.

## Strengths and Limitations

Our study has a robust randomized single-blind and placebo-controlled crossover design performed in a hypobaric chamber able to exactly replicate environmental conditions for all participants. Our setting is not able to simulate a real HEMS rescue operation with raised sympathetic activity and alertness, which might influence CC quality. The results should be verified in further studies in simulated environment with different environmental factors (eg, cold and wind) and in field studies. Our participants were randomly exposed to 2 out of the 3 altitudes because of their limited time availability; the methodological choice was supported by a solid statistical design. Our study was initially not designed to investigate sex differences, and we did not balance the participants by sex; we suggest verifying such questions in specifically designed studies.

## CONCLUSIONS

This randomized single-blind and placebo-controlled trial shows a time-dependent decrease in CCO-CPR quality provided by HEMS personnel after rapid ascent (20 minutes) to altitude (3000 and 5000 m). After 60 to 90 seconds CC depth tended to drop below the standard limit of 50 mm at both altitudes. This loss of quality was not perceived by the providers. We suggest reevaluation of CPR guidelines for providers practicing at altitudes of 3000 m and higher, considering a shorter CC cycle, or the use of a mechanical CPR device. Mechanical CPR devices could be of help in overcoming CCO-CPR quality decrease in HEMS missions.

## ARTICLE INFORMATION

Received February 4, 2021; accepted September 2, 2021.

### Affiliations

Institute of Mountain Emergency Medicine, Eurac Research, Bolzano, Italy (A.V., M.J.v.V., T.D.C., M.F., G.N., A.D., M.P., H.B., G.S.); Department of Psychology and Cognitive Science, Center for Mind/Brain Sciences, CIMeC, University of Trento, Rovereto, Trento, Italy (M.F.); Department of Anesthesiology, University Hospital of Regensburg, Germany (A.D.); Department of Psychiatry, Psychotherapy and Psychosomatics, University Hospital for Psychiatry II, Innsbruck Medical University, Innsbruck, Austria (K.H.); and International Commission for Mountain Emergency Medicine (ICAR MEDCOM), Klotten, Switzerland (H.B., G.S.).

## Acknowledgments

We thank Markus Falk (Eurac Research, Italy) for the support in experimental design preparation, Jonas Brandner (Faculty of Medicine, Innsbruck Medical University, Austria) for support in experimental setting preparation and data collection, the colleagues from the terraXcube facility (Eurac Research, Italy) for support in experimental setting preparation, and the colleagues of the International Commission for Alpine Rescue (ICAR, Klotten, Switzerland) and Dr Marc Kaufmann for invaluable scientific discussion. We thank Lukas Innerhofer and Weisses Kreuz—Croce Bianca (Bolzano, Italy) for providing the resuscitation manikins. The authors thank the Department of Innovation, Research, University and Museums of the Autonomous Province of Bozen/Bolzano, Italy for covering the Open Access publication costs.

## Sources of Funding

This study was supported by internal funding only.

## Disclosures

None.

## Supplementary Material

Table S1  
Figure S1

## REFERENCES

- Lo MY, Daniels JD, Levine BD, Burtcher M. Sleeping altitude and sudden cardiac death. *Am Heart J*. 2013;166:71–75. doi: 10.1016/j.ahj.2013.04.003
- Ströhle M, Paal P, Strapazzon G, Avancini G, Procter E, Brugger H. Defibrillation in rural areas. *Am J Emerg Med*. 2014;32:1408–1412. doi: 10.1016/j.ajem.2014.08.046
- Strapazzon G, Ponchia A, Ellerton J, Brugger H. Risk assessment and emergency management of coronary heart disease at altitude. *High Alt Med Biol*. 2011;12:97–98; author reply 9–100. doi: 10.1089/ham.2010.1085
- Parati G, Agostoni P, Basnyat B, Bilo G, Brugger H, Coca A, Festi L, Giardini G, Lironcurti A, Luks AM, et al. Clinical recommendations for high altitude exposure of individuals with pre-existing cardiovascular conditions: a joint statement by the European Society of Cardiology, the Council on Hypertension of the European Society of Cardiology, the European Society of Hypertension, the International Society of Mountain Medicine, the Italian Society of Hypertension and the Italian Society of Mountain Medicine. *Eur Heart J*. 2018;39:1546–1554. doi: 10.1093/eurheartj/ehx720
- Rossi VA, Schmied C, Niebauer J, Niederseer D. Cardiovascular effects and risks of recreational alpine skiing in the elderly. *J Sci Med Sport*. 2019;22:S27–S33. doi: 10.1016/j.jsams.2019.01.016
- Perkins GD, Handley AJ, Koster RW, Castrén M, Smyth MA, Olasveengen T, Monsieurs KG, Raffay V, Gräsner J-T, Wenzel V, et al. European Resuscitation Council Guidelines for Resuscitation 2015: section 2. Adult basic life support and automated external defibrillation. *Resuscitation*. 2015;95:81–99. doi: 10.1016/j.resuscitation.2015.07.015
- Moens D, Stipulante S, Donneau AF, Hartstein G, Pirotte O, D'orio V, Ghuysen A. Air versus ground transport of patients with acute myocardial infarction: experience in a rural-based helicopter medical service. *Eur J Emerg Med*. 2015;22:273–278. doi: 10.1097/MEJ.0000000000000149
- International Virtual Aviation Organization (IVA). *Helicopter Instrument Straight Climbs Instrument Flying Handbook FAA-H-8083-15B*. U.S. Department of Transportation, Federal Aviation Administration; 2020.
- West JB. High-altitude medicine. *Am J Respir Crit Care Med*. 2012;186:1229–1237. doi: 10.1164/rccm.201207-1323CI
- Coppel J, Hennis P, Gilbert-Kawai E, Grocott MP. The physiological effects of hypobaric hypoxia versus normobaric hypoxia: a systematic review of crossover trials. *Extrem Physiol Med*. 2015;4:2. doi: 10.1186/s13728-014-0021-6
- Sato T, Takazawa T, Inoue M, Tada Y, Suto T, Tobe M, Saito S. Cardiorespiratory dynamics of rescuers during cardiopulmonary resuscitation in a hypoxic environment. *Am J Emerg Med*. 2018;36:1561–1564. doi: 10.1016/j.ajem.2018.01.029
- Wang JC, Tsai SH, Chen YL, Hsu CW, Lai KC, Liao WI, Li LY, Kao WF, Fan JS, Chen YH. The physiological effects and quality of chest

- compressions during CPR at sea level and high altitude. *Am J Emerg Med.* 2014;32:1183–1188. doi: 10.1016/j.ajem.2014.07.007
13. Schulz KF, Altman DG, Moher D. CONSORT 2010 statement: updated guidelines for reporting parallel group randomised trials. *BMJ.* 2010;340:c332. doi: 10.1136/bmj.c332
  14. American Society of Anesthesiologists. ASA physical status classification system. Original approval: 2014. Last amended: 2020. Available at: [www.asahq.org](http://www.asahq.org), <https://www.asahq.org/standards-and-guidelines/asa-physical-status-classification-system>. Accessed January 21, 2020.
  15. Perk J, De Backer G, Gohlke H, Graham I, Reiner Z, Verschuren WM, Albus C, Benlian P, Boysen G, Cifkova R, et al. European Guidelines on Cardiovascular Disease Prevention in Clinical Practice (version 2012). The Fifth Joint Task Force of the European Society of Cardiology and other Societies on Cardiovascular Disease Prevention in Clinical Practice (constituted by representatives of nine societies and by invited experts). *Eur Heart J.* 2012;33:1635–1701. doi: 10.1093/eurheartj/ehs092
  16. Panchal AR, Bartos JA, Cabañas JG, Donnino MW, Drennan IR, Hirsch KG, Kudenchuk PJ, Kurz MC, Lavonas EJ, Morley PT, et al.; on behalf of the Adult Basic and Advanced Life Support Writing Group. Part 3: adult basic and advanced life support: 2020 American Heart Association Guidelines for Cardiopulmonary Resuscitation and Emergency Cardiovascular Care. *Circulation.* 2020;142:S366–S468. doi: 10.1161/CIR.0000000000000916
  17. Vadeboncoeur T, Stolz U, Panchal A, Silver A, Venuti M, Tobin J, Smith G, Nunez M, Karamooz M, Spaitte D, et al. Chest compression depth and survival in out-of-hospital cardiac arrest. *Resuscitation.* 2014;85:182–188. doi: 10.1016/j.resuscitation.2013.10.002
  18. Stiell IG, Brown SP, Christenson J, Cheskes S, Nichol G, Powell J, Bigham B, Morrison LJ, Larsen J, Hess E, et al. What is the role of chest compression depth during out-of-hospital cardiac arrest resuscitation? *Crit Care Med.* 2012;40:1192. doi: 10.1097/CCM.0b013e31823bc8bb
  19. Ochoa FJ, Ramalle-Gómara E, Lisa V, Saralegui I. The effect of rescuer fatigue on the quality of chest compressions. *Resuscitation.* 1998;37:149–152. doi: 10.1016/S0300-9572(98)00057-4
  20. Nishiyama C, Iwami T, Kawamura T, Ando M, Yonemoto N, Hiraide A, Nonogi H. Quality of chest compressions during continuous CPR; comparison between chest compression-only CPR and conventional CPR. *Resuscitation.* 2010;81:1152–1155. doi: 10.1016/j.resuscitation.2010.05.008
  21. Hightower D, Thomas SH, Stone CK, Dunn K, March JA. Decay in quality of closed-chest compressions over time. *Ann Emerg Med.* 1995;26:300–303. doi: 10.1016/S0196-0644(95)70076-5
  22. Wang PL, Brooks SC. Mechanical versus manual chest compressions for cardiac arrest. *Cochrane Database Syst Rev.* 2018;8:CD007260. doi: 10.1002/14651858.CD007260.pub4
  23. Putzer G, Braun P, Zimmermann A, Pedross F, Strapazzon G, Brugger H, Paal P. LUCAS compared to manual cardiopulmonary resuscitation is more effective during helicopter rescue—a prospective, randomized, cross-over manikin study. *Am J Emerg Med.* 2013;31:384–389. doi: 10.1016/j.ajem.2012.07.018
  24. Rauch S, Strapazzon G, Brodmann M, Fop E, Masoner C, Rauch L, Forti A, Pietsch U, Mair P, Brugger H. Implementation of a mechanical CPR device in a physician staffed HEMS—a prospective observational study. *Scand J Trauma Resusc Emerg Med.* 2018;26:36. doi: 10.1186/s13049-018-0503-4
  25. Yannopoulos D, Bartos JA, Martin C, Raveendran G, Missov E, Conterato M, Frascione RJ, Trembley A, Sipprell K, John R, et al. Minnesota resuscitation consortium's advanced perfusion and reperfusion cardiac life support strategy for out-of-hospital refractory ventricular fibrillation. *J Am Heart Assoc.* 2016;5:e003732. doi: 10.1161/JAHA.116.003732
  26. Ashton A, McCluskey A, Gwinnutt CL, Keenan AM. Effect of rescuer fatigue on performance of continuous external chest compressions over 3 min. *Resuscitation.* 2002;55:151–155. doi: 10.1016/S0300-9572(02)00168-5

# **SUPPLEMENTAL MATERIAL**

**Table S1.** Correlation coefficients (r) per day for the visual analogue scale (VAS) performance and VAS exhaustion with mean value of 5 min test of depth, rate, effective chest compressions and recoil.

Parameter (mean value of 5 min test)	Subjective VAS performance				Subjective VAS effort			
	day 1		day 2		day 1		day 2	
	r	P value	r	P value	r	P value	r	P value
Depth	-0.204	0.164	-0.045	0.763	0.183	0.212	0.169	0.251
Rate	0.137	0.352	-0.016	0.915	-0.001	0.992	0.076	0.607
Effective chest compressions	-0.206	0.159	-0.167	0.256	0.102	0.492	0.147	0.318
Recoil	0.033	0.825	-0.090	0.544	-0.089	0.548	-0.110	0.457

VAS = Visual Analogue Scale

**Figure S1. Interaction effect of 30 s period with sex on depth (A), rate (B) and number of effective chest compressions (C).**

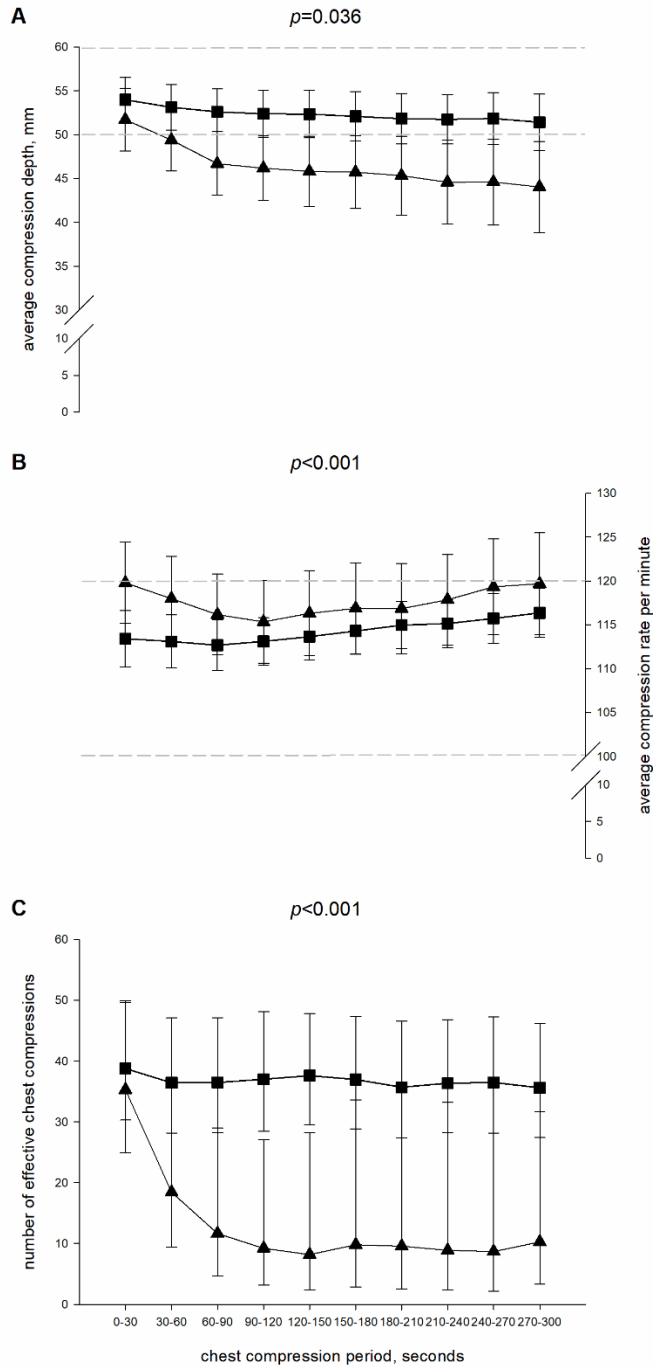

Triangles represent estimated means by generalized estimating equations (GEE) for females and squares for males. Grey dashed lines indicate European Resuscitation (ERC) guidelines limits and error bars represent 95% confidence interval of the estimated mean.