





STANDARD ARTICLE

Allergen-specific immunoglobulin E in sera of horses affected with insect bite hypersensitivity, severe equine asthma or both conditions

Maëva Verdon¹  | Simone Lanz¹  | Claudio Rhyner²  | Vinzenz Gerber¹  |
Eliane Marti³ 

¹Equine clinic, Swiss Institute of Equine Medicine, University of Bern and Agroscope, Berne, Switzerland

²Department of Vaccine Development, Swiss Institute of Allergy and Asthma Research (SIAF), University of Zürich, Davos, Switzerland

³Department of Clinical Research, University of Bern, Berne, Switzerland

Correspondence

Maëva Verdon, Equine clinic, Swiss Institute of Equine Medicine, University of Bern, and Agroscope, Länggassstrasse 124, 3012 Berne, Switzerland.

Email: maeva.verdon@vetuisse.unibe.ch

Funding information

Institut Suisse de Médecine Équine, Grant/Award Number: Account : 39-890; Schweizerischer Nationalfonds zur Förderung der Wissenschaftlichen Forschung, Grant/Award Numbers: 310030-160196 and 131003A162548/1

Background: Genetic, epidemiologic, and clinical evidence suggests that, in horses, there are manifestations of hypersensitivity that can occur together.

Objectives: To investigate whether concurrent insect bite hypersensitivity (IBH) and severe equine asthma (EA) is associated with higher allergen-specific and total serum immunoglobulin E (IgE) concentrations than only EA or IBH.

Animals: Healthy control horses (C, n = 40), horses with IBH (IBH, n = 24), severe EA (EA, n = 18), and both conditions (IBH/EA, n = 23) were included.

Methods: In our retrospective comparative study, sera from horses with signs of severe EA, IBH, and control animals were used. IgE specific for 15 recombinant (r) allergens as well as total serum IgE concentrations were measured by enzyme-linked immunosorbent assay.

Results: Group IBH (median sum r-*Culicoides* IgE: optical density at 405 nm [OD₄₀₅] = 3.54 [0.48-15.07]) and group IBH/EA (OD₄₀₅ = 4.55 [0.46-17.15]) had significantly ($P < .001$) higher IgE against *Culicoides* r-allergens than groups C (OD₄₀₅ = 0.44 [0.21-2.05]) and EA (OD₄₀₅ = 0.6 [0.2-2.9]). There were no significant ($P > .05$) differences between group IBH and group IBH/EA. No significant differences among the groups were found for the other r-allergens or total serum IgE concentration. Compared to controls, horses with severe IBH had significantly increased IgE concentration to 5 *Culicoides* r-allergens ($P < .05$), whereas horses with moderate IBH had significantly increased IgE concentration to only 3 *Culicoides* r-allergens ($P < .05$).

Conclusions and Clinical Importance: Susceptibility of IBH-affected horses to develop EA is likely not associated with IgE-mediated immune reactions but with other immunopathological mechanisms.

KEYWORDS

equine asthma, horse, immunoglobulin E, insect bite hypersensitivity, multiple equine allergies

Abbreviations: EA, equine asthma; HOARSI, Horse Owner Assessed Respiratory Signs Index; IBH, insect bite hypersensitivity; IgE, serum immunoglobulin E; OD, optical density; r Asp f, recombinant *Aspergillus fumigatus*; r Cla h, recombinant *Cladosporium herbarum*; r Cul n, recombinant *Culicoides nubeculosus*; r Cul o, recombinant *Culicoides obsoletus*; r Der p, recombinant *Dermatophagoides pteronyssinus*; r Gly d, recombinant *Glycophagus domesticus*; r, recombinant; RAO, recurrent airway obstruction; RT, room temperature.

Vinzenz Gerber and Eliane Marti contributed equally to this study.

1 | INTRODUCTION

Genetic, epidemiologic, and clinical evidence suggests that, in horses, as in other species, different manifestations of hypersensitivity occur concurrently.^{1,2} In humans, the “atopic march” manifests as a temporal sequence of hypersensitivities, with atopic dermatitis in the neonate preceding the development of allergic rhinitis and asthma.³ The atopic march and multiple allergies in humans can be associated with

This is an open access article under the terms of the Creative Commons Attribution-NonCommercial License, which permits use, distribution and reproduction in any medium, provided the original work is properly cited and is not used for commercial purposes.

© 2018 The Authors. *Journal of Veterinary Internal Medicine* published by Wiley Periodicals, Inc. on behalf of the American College of Veterinary Internal Medicine.

increased total serum immunoglobulin E (IgE), IgE cross-reactivity between different allergens, or both.^{3,4}

In horses, multiple hypersensitivities can manifest as the combined occurrence of equine asthma (EA), insect bite hypersensitivity (IBH), and chronic recurrent urticaria. Particularly, the prevalence of IBH is increased in recurrent airway obstruction (RAO)-affected horses and vice-versa.¹ Although longitudinal studies in affected horses are lacking, the typical earlier onset of IBH compared to RAO⁵ suggests that as in humans with multiple hypersensitivity disorder, a dysfunctional skin barrier serves as the site of allergen sensitization, resulting in a systemic T-helper-2 immunity which is a predisposing factor for the development of respiratory allergies.⁶

IBH is an allergic dermatitis provoked by *Culicoides* midge bites.⁵ Affected horses have intense pruritus, which results in typical skin lesions localized mainly along the dorsal midline and the base of the tail and the mane.⁵ The involvement of IgE-mediated reactions in the pathogenesis of this disease has been clearly established.⁵ The specific *Culicoides* allergens causing IBH have been identified at the molecular level and produced as pure recombinant (r) allergens.^{5,7,8} The use of these r-allergens compared to crude *Culicoides nubeculosus* whole-body extract improves the sensitivity and specificity of serologic IgE tests for IBH.⁹

EA encompasses inflammatory airway disease (the mild to moderate form of EA) and RAO, also known as heaves, the severe form.¹⁰ Dyspnea, coughing, and loss of performance are the most commonly observed clinical signs, caused mainly by the bronchoconstriction and the compromised gas exchange.¹¹ The exact immunopathogenesis of severe EA remains unclear,¹² and the involvement of IgE-mediated reactions is still controversial, but a part of horses with severe EA have increased IgE concentrations against r Asp f allergens.¹³⁻¹⁵ Even less is known about the pathogenesis and potential involvement of IgE in the milder forms of EA.¹⁰

Based on these findings, the aim of our study was to investigate allergen-specific IgE concentrations in the sera of healthy control (C) horses as well as horses with IBH, EA, and both conditions, using a panel of r-allergens including r Asp f and r-*Culicoides* allergens. A 2nd aim was to investigate whether allergic horses had increased serum IgE concentrations specific for r-allergens not previously tested in the horse (*r-Cladosporium herbarum* [r Cla h] 8, *r-Glycophagus domesticus* [r Gly d] 2, and *r-Dermatophagoides pteronyssinus* [r Der p] 23). Thus, a panel of different allergen classes that included midge, mold, and mite r-allergens was used to test the hypothesis that horses with both conditions, specifically IBH and EA, have more diverse and augmented reactions across the allergen classes compared to healthy horses and compared to horses with IBH or EA alone.

2 | MATERIALS AND METHODS

2.1 | Study design

The serum used in our study was drawn from horses that were included in 3 previously published studies (Supporting Information Table S1).^{2,16,17} The studies were approved by the Animal Experimental Committees of the Cantons of Berne, Freiburg, Solothurn, and Geneva, Switzerland (BE10/13; 58/10; 118/16). Four groups were defined using

questionnaire-based and clinical information: healthy controls (group C), IBH-affected horses (group IBH), severe EA-affected horses (group EA), and horses with both IBH and EA (group IBH/EA).

Samples from 69 horses included in Lanz et al (2017)² formed group IBH (n = 24), group IBH/EA (n = 23), and 22 samples of group C. Because no horses affected with severe EA only were included in our study² and increased concentrations of IgE specific for mold allergens had previously been described in horses with severe EA, samples from horses with severe EA and matched controls were drawn from 2 previous studies^{16,17} to form group EA (n = 18) and to complement group C with 18 controls. Samples were selected based on availability and on the Horse Owner Assessed Respiratory Signs Index (HOARSI).

2.2 | Serum samples, horse population structures, and group definitions

Blood was collected from the jugular vein using Serum Clot Activator-containing vacutainers (Vacurette; GreinerBioOne, St. Gallen, Switzerland). The blood was centrifuged for 10 minutes at 2000g, and serum was separated and stored at -80°C until used.

For every horse, IBH severity and lung health status were determined using standardized questionnaires. All horses were withdrawn from medication for at least 2 weeks before clinical examination and blood sampling. Some of the horses with asthma had been treated with corticosteroids, bronchodilators, or both. Preventive measures such as blankets and repellents were used in some of the IBH-affected horses to decrease exposure to insects.

The standardized IBH score, based on the most severe clinical signs the horse had experienced (Supporting Information Table S1), was performed as described.² Briefly, cutaneous lesions observed on the mane, tail, head, and ventral midline were classified according to 5 severity grades ranging from 0 (no signs of IBH) to 5 (bleeding from self-inflicted abrasions). Horses were classified as IBH-positive, if the IBH score was >0 and if they were seasonally affected (season consistent with exposure to insects, ie, spring to fall exacerbation). Because clinical signs of IBH are typical, 1 season of observed clinical signs was sufficient to qualify.

The HOARSI was used to grade EA severity and has been previously described and validated.¹⁶⁻¹⁸ The HOARSI also referred to the most severe clinical signs in the horse's history. Horses graded HOARSI 1 were classified as healthy, whereas HOARSI 2 (mild), HOARSI 3 (moderate), and HOARSI 4 (severe) were consistent with EA. Because increased allergen-specific IgE concentrations have only been described in the severe form of EA,^{13,14} horses for this group were selected based on the following parameters: HOARSI ≥3 and partial pressure of arterial oxygen <90 mm Hg, measured as described in the 3 previous studies.^{2,16,17}

The control horses had no clinical signs or owner-reported history of IBH or severe EA. To help avoid false-negative control animals, all horses had to have spent at least 1 warm season (spring to fall) in Switzerland exposed to *Culicoides* and also had to be exposed previously to hay for at least 2 months.

2.3 | Allergens

The IgE concentrations specific to the 15 different r-allergens were measured in the horse sera. Detailed information about the allergens

used is given in Table 1. They consisted of 4 r-*A. fumigatus* allergens, expressed and purified as previously described,^{19,20} 8 r-*Culicoides* allergens, 4 derived from *Culicoides obsoletus*, and 4 from *C. nubeculosus*, all also expressed in *Escherichia coli* and purified as described in a previous study.²¹ The *Culicoides* allergens were chosen based on unpublished data showing that these r-*Culicoides* allergens were the most relevant ones for horses in Switzerland. Additionally, in an exploratory study, 1 commercially available r-allergen from the mold *C. herbarum* (Cla h 8; Biomay AG, Vienna, Austria) and 2 r-mite allergens, *D. pteronyssinus* 23 (Der p 23; Biomay AG) expressed in *Escherichia coli*, and *G. domesticus* 2 expressed in *Pichia pastoris* (Gly d 2; Indoor Biotechnologies Inc, Charlottesville) were used.

2.4 | Allergen-specific IgE ELISA

Allergen-specific serum IgE against the different r-allergens was determined by ELISA, as described previously.²² Briefly, 96-well high-binding polystyrene plates (Milian SA, Geneva, Switzerland) were coated with 2 µg/mL of the allergen in coating buffer (0.2 M carbonate-bicarbonate buffer pH 9.4) at 37°C for 2 hours. After washing the plates twice in washing buffer (phosphate-buffered saline [PBS] pH 7.4 containing 0.05% Tween 20), plates were blocked with blocking buffer (PBS pH 7.4, 5% milk powder, 0.05% Tween 20) for 1 hour at 37°C. All dilutions of serum samples and antibodies were made with blocking buffer. After washing, test serum samples were randomly added in duplicates to the plates at a dilution of 1 : 5 and incubated at 4°C overnight. After washing, a monoclonal mouse antibody-specific for equine IgE (1 µg/mL, clone 3H10)²³ was added and incubated for 2 hours at room temperature (RT) on a shaker. After washing, alkaline phosphatase-conjugated, affinity-purified goat-anti-mouse IgG (1 : 2000; Jackson Immuno Research, Newmarket, UK) was added and the plates developed using 1.5 mg/mL phosphatase

substrate (Sigma-Aldrich Chemie GmbH, Buchs, Switzerland) in 10% diethanolamine (Carl Roth GmbH + Co. KG, Karlsruhe, Germany), pH 9.8. After 2 hours, absorbance was measured as optical density at 405 nm (OD₄₀₅ nm). ELISA results were shown as OD₄₀₅ nm values after a blank correction on the optical density and correction between plates, as described in our study.⁸

Because of the individual reaction patterns of the horses to the single r-allergens, the sum of IgE concentrations against all 8 tested r-*Culicoides* allergens were calculated for each horse and used for additional analyses. Accordingly, IgE concentrations to the mold or the mite allergens were also summed up for analysis.

2.5 | Determination of total serum IgE concentrations

Total IgE concentrations were determined in the sera of the horses as previously described.^{23,24} Briefly, plates were coated with 1 µg/mL monoclonal mouse anti-IgE 1C12 in coating buffer (0.05 M carbonate buffer, pH 9.4) and incubated overnight at 4°C. The plates were washed with wash buffer (PBS 0.05% Tween, pH 7.4) and then blocked with 100 µL blocking buffer (PBS Tween 0.5% BSA) for 30 minutes at RT. Dilutions of standard sera or horse sera (dilution 1 : 50) were made in blocking buffer, diluted serially 2-fold and incubated at RT for 2 hours and 30 minutes. After washing, a biotin conjugate monoclonal mouse anti-equine IgE mAb 3H10²³ was added and incubated for a further 2 hours and 30 minutes. After a further wash, 100 µL of a 1 : 10 000 dilution Extravidin alkaline phosphatase (Sigma-Aldrich Chemie GmbH, Buchs, Switzerland) was added and plates incubated for 1 hour, on a shaker, at RT. After a final wash, the ELISA was developed with 1 mg/mL phosphatase substrate dissolved in 10% diethanolamine pH 9.8 (Carl Roth GmbH Co. KG, Karlsruhe, Germany). Plates were finally incubated in the dark, at RT, and were

TABLE 1 Recombinant (r) allergens used in the study

Allergens	Name recombinant	Function	Genbank accession Number	References
Molds				
<i>Aspergillus fumigatus</i>	r Asp f 4	Unknown	AJ001732	Crameri et al (1999) ²⁰
	r Asp f 6	MnSOD	U53561	Crameri et al (1999) ²⁰
	r Asp f 7	Unknown	AJ223315	Crameri et al (1999) ²⁰
	r Asp f 8	Ribosomal P2 protein	AJ224333	Mayer et al (1999) ¹⁹
<i>Cladosporium herbarum</i>	r Cla h 8	Mannitol dehydrogenase	Commercial	Biomay
Mites				
<i>Glycophagus domesticus</i>	r Gly d 2	NPC2 family	Commercial	Indoor biotechnologies
<i>Dermatophagoides pteronyssinus</i>	r Der p 23	Peritrophin-like proteins	Commercial	Biomay
Culicoides				
<i>Culicoides obsoletus</i>	r Cul o 1P	Kunitz BPI	JX512273	Peeters et al (2013) ⁸
	r Cul o 2P	D7-related	JX512274	Peeters et al (2013) ⁸
	r Cul o 3	Antigen-5 like	KC339673	Van der Meide et al (2013) ⁷
	r Cul o 6	D7-related	KC339676	Van der Meide et al (2013) ⁷
<i>Culicoides nubeculosus</i>	r Cul n 3	Unknown	HM145951	Schaffartzik et al (2011) ²¹
	r Cul n 4	Unknown	HM145952	Schaffartzik et al (2011) ²¹
	r Cul n 5	Unknown	HM145953	Schaffartzik et al (2011) ²¹
	r Cul n 9	D7-related	HM145957	Schaffartzik et al (2011) ²¹

Abbreviations: r Asp f, recombinant *Aspergillus fumigatus*; r Cla h, recombinant *Cladosporium herbarum*; r Cul n, recombinant *Culicoides nubeculosus*; r Der p, recombinant *Dermatophagoides pteronyssinus*; r Gly d, recombinant *Glycophagus domesticus*.

read after 30 minutes, 1 hour, and until the OD₄₀₅ nm of the highest concentration of the standard curve reached 1.00. As a standard, a 6-fold dilution of a horse serum with a known IgE concentration ranging from 4 to 128 ng/mL was used. This sample was tested in duplicate. The OD of the sera was introduced from the standard curves to get their corresponding IgE concentration expressed as ng/mL value and was subsequently multiplied by the dilution factor. The concentration of the sera is shown as the mean of the values from those dilutions where the concentration was within the standard curve. All samples were randomly distributed on 8 plates.

2.6 | Statistical analyses

Statistical analyses were carried out using the statistical package NCSS 2011 (NCSS Statistical Software, Kaysville, Utah). A 1st analysis indicated that allergen-specific IgE concentrations were not distributed normally; therefore, medians and ranges were used for descriptive statistics.

The nonparametric Kruskal-Wallis Multiple-Comparison Z-Value test (Dunn's test) with Bonferroni correction for multiple comparisons was used to analyze differences in allergen-specific IgE concentrations among the 4 groups of horses and for total serum IgE concentrations in IBH, IBH/EA, and C horses from the most recent study.² Before merging the control horses from the 3 studies to a single control group, IgE concentrations were tested for differences among controls drawn from the 3 studies. The results are communicated accordingly.

Associations between EA or IBH and allergen-specific IgE concentrations were also tested in the Kruskal-Wallis Multiple-Comparison Z-Value test by comparing horses with IBH to horses without IBH, independently of a concomitant affection with EA. The same was done for EA. Similarly, EA-affected horses were also compared to horses without EA (Table 3).

To analyze a possible effect of the IBH severity score on specific IgE, horses from Lanz et al (2017)² were used. Because the number of IBH-affected horses in each score group was too small for statistical

analysis, the horses with scores from 1 to 3, moderate IBH (see Supporting Information Table S1), were pooled. Accordingly, horses with more severe IBH (scores 4 and 5, severe IBH) were also pooled for the analysis. Consequently, r-Culicoides allergen-specific IgE concentrations in the sera of horses without IBH (score = 0, n = 22), with moderate IBH (score 1-3, n = 23), or severe IBH (score 4-5, n = 24) were compared using a Kruskal-Wallis Multiple-Comparison Z-Value test (Dunn's test) with Bonferroni correction for multiple comparisons.

The level of significance was set at P ≤ .05. Results are presented as median (range).

3 | RESULTS

The total sample set included 105 horses of various breeds and sexes (4 stallions, 54 mares, and 47 geldings) aged 3-27 years (Supporting Information Table S1, Figure 1). There were no significant differences in breed, age, or sex distribution among the 4 groups of horses (IBH, IBH/EA, EA, and control horses) used in our study. A 1st analysis showed that IgE concentrations in the sera of the group C from the study by Lanz et al (2017)² did not differ significantly from those of group C horses derived from the studies by Rettmer et al (2014)¹⁶ and Laumen et al (2010),¹⁷ except for r-Asp f 8, where group C horses from the older studies had higher rAsp f 8-specific IgE (OD₄₀₅ = 0.10 nm [0.03-0.33 nm] versus 0.06 nm [0-0.36 nm], P = .04, Mann Whitney U test). Thus, for this allergen, the results from the samples from Lanz et al (2017)² were analyzed separately from those of the 2 other studies.^{16,17}

The detailed data of total and allergen-specific IgE concentration are presented in Table 2. The following results are summarized by allergen classes.

3.1 | Allergen-specific IgE against midges

Comparison of r-Culicoides allergen-specific IgE concentrations in the 4 groups of horses showed that groups IBH and IBH/EA had

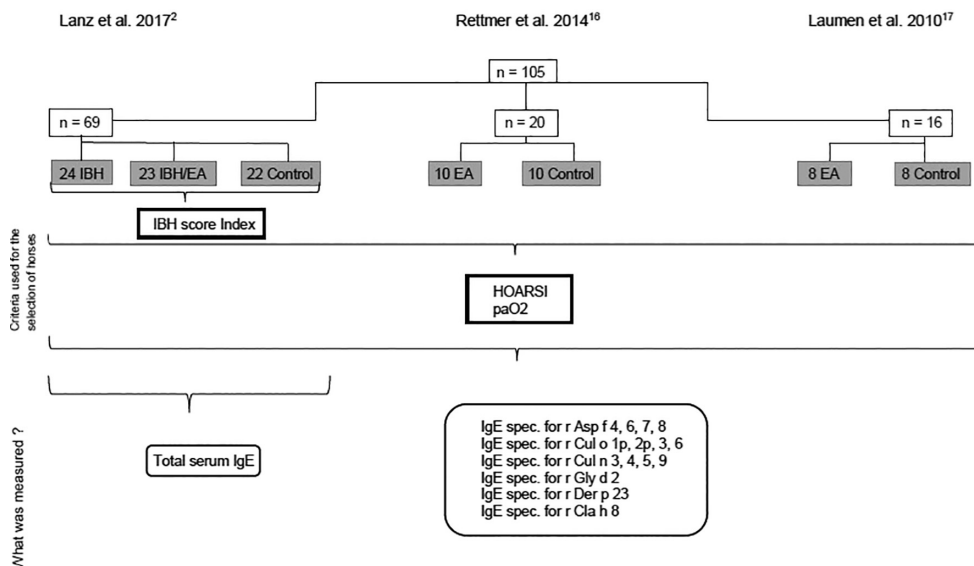

FIGURE 1 Demographics of the horse populations used in the 3 studies

TABLE 2 Results of allergen-specific IgE concentrations in horses sera

Allergens	EA (N = 18)	IBH (N = 24)	IBH/EA (N = 23)	Control (N = 40)	P-value 1-way ANOVA
r Cul o 1P	0.089 ^{a,b} (0.001-2.29)	0.65 ^{a,c} (0.033-3.11)	0.76 ^{b,d} (0.01-3.096)	0.073 ^{c,d} (0.001-0.41)	<.001
r Cul o 2P	0.033 ^{a,d} (0-0.086)	0.23 ^{a,c} (0.003-3.19)	0.13 ^{b,d} (0.004-3.25)	0.047 ^{c,d} (0-0.98)	<.001
r Cul o 3	0.074 (0.01-0.19)	0.22 ^a (0-3.22)	0.087 ^b (0-3.42)	0.04 ^{a,b} (0-0.81)	≤.001
r Cul o 6	0.025 ^{a,b} (0-0.087)	0.11 ^a (0-3.22)	0.091 ^b (0-3.22)	0.046 (0-0.27)	≤.001
r Cul n 3	0.12 (0.027-0.19)	0.24 ^a (0.022-3.022)	0.12 (0.015-1.69)	0.11 ^a (0.012-0.75)	.01
r Cul n 4	0.08 (0-0.18)	0.151 (0-1.12)	0.13 (0-3.17)	0.095 (0-0.55)	.052
r Cul n 5	0.044 (0.027-0.35)	0.086 (0.003-2.67)	0.088 (0-1.13)	0.057 (0-0.37)	.089
r Cul n 9	0.08 (0.016-0.206)	0.105 (0.006-1.96)	0.16 (0-3.35)	0.082 (0-0.69)	NS
Sum <i>Culicoides</i>	0.6 ^{a,b} (0.2-2.9)	3.54 ^{a,c} (0.48-15.067)	4.548 ^{b,d} (0.46-17.15)	0.44 ^{c,d} (0.21-2.052)	<.001
r Asp f 4	0.067 (0-0.28)	0.023 (0-0.19)	0.038 (0-0.29)	0.043 (0-0.33)	NS
r Asp f 6	0.098 (0-0.51)	0.17 (0-0.74)	0.12 (0-0.47)	0.16 (0-0.55)	NS
r Asp f 7	0.057 ^a (0.033-0.18)	0.031 (0-0.2)	0.016 ^{a,b} (0-0.36)	0.048 ^b (0-0.23)	≤.01
r Asp f 8 Lanz et al ²	NA	0.045 (0-1.3)	0.069 (0-1.4)	0.057 (0-0.36)	NS
r Asp f 8 Rettmer et al, ¹⁶ Laumen et al ¹⁷	0.123 (0.04-0.36)	NA	NA	0.102 (0.033-0.33)	NS
r Cla h 8	0 (0-0.054)	0 (0-0.18)	0 (0-0.17)	0 (0-0.18)	NS
Sum molds	0.35 (0.062-1.29)	0.333 (0.052-1.84)	0.36 (0.109-1.93)	0.338 (0.022-1.00)	NS
r Der p 23	0.086 (0-0.31)	0.046 (0-0.72)	0.035 (0-0.74)	0.067 (0-0.27)	NS
r Gly d 2	0.066 (0-0.34)	0.15 (0-0.31)	0.098 (0-0.69)	0.088 (0-0.33)	NS
Sum mites	0.16 (0-0.66)	0.21 (0.038-0.93)	0.13 (0.004-0.9)	0.16 (0-0.5)	NS
Total IgE*	NA	14.19 (0-56.62)	10.81 (0-63.13)	6.88 (0-63.13)	NS
Sum all IgE	1.011 ^{a,b} (0.33-4.36)	3.97 ^{a,c} (0.96-16.77)	3.78 ^{b,d} (0.84-20.67)	1.24 ^{c,d} (0.43-2.86)	<.001

Abbreviations: EA, equine asthma; IBH, insect bite hypersensitivity; IgE, immunoglobulin E; NS, nonsignificant; NA, not analyzed; r Asp f, recombinant *Aspergillus fumigatus*; r Cla h, recombinant *Cladosporium herbarum*; r Cul n, recombinant *Culicoides nubeculosus*; r Der p, recombinant *Dermatophagoides pteronyssinus*; r Gly d, recombinant *Glycophagus domesticus*.

Median OD₄₀₅ (range) of IgE concentrations in sera of horses affected with severe EA, IBH, both IBH and EA, and in non-affected control horses. Same superscript letters indicate statistically significant differences ($P \leq .05$) in Kruskal-Wallis Z-value test.

*Only tested in sera from study by Lanz et al (2017),² that is, control horses n = 22.

significantly higher IgE concentrations than group C or group EA against r-Cul o 1P, r-Cul o 2P, and the sum of *Culicoides* allergen-specific IgE (Table 2, Figure 2). Furthermore, groups IBH and IBH/EA had significantly higher r-Cul o 3-specific IgE than group C. For r-Cul o 6-specific IgE concentrations, the medians were only significantly different from group EA and not from group C. The differences between the groups for the r-Cul n allergens were statistically significant for r-Cul n 3 and r-Cul n 4 ($P \leq .05$), where horses of group IBH had significantly higher IgE than group C. Nevertheless, IgE concentrations against each of the tested r-*Culicoides* allergens, including the Cul n r-allergens, were significantly higher in horses with IBH compared to horses without IBH, independently of the presence or absence of EA (Supporting Information Table S2).

3.2 | Allergen-specific IgE against mold and mite allergens

No significant differences among the 4 groups of horses were detected for IgE concentrations against the mold allergens r-Cla h 8, r-Asp f 4, r-Asp f 6, and r-Asp f 8 or the mite allergens r-Der p 23 and r-Gly d 2. Group IBH/EA had significantly lower r-Asp f 7-specific IgE than groups EA and C. No significant differences among the 4 horse groups were found for r-Asp f 8.

3.3 | Total serum IgE concentrations

There was a high variation of total IgE concentrations among the horses, with values ranging from 0 to 147.74 µg/mL (Table 2, Supporting Information Figure 4).

However, a clinical diagnosis of IBH or of severe EA was not associated with the total IgE concentrations observed in our population. Group IBH (14.2 µg/mL [0-56.62 µg/mL]) and group IBH/EA (10.8 µg/mL [0-147.74 µg/mL]) did not have significantly different values when compared to group C (6.9 µg/mL [0-63.13] µg/mL; $P = .37$).

3.4 | Influence of IBH severity on allergen-specific serum IgE concentrations

Grouping of the horses according to their IBH severity score (Table 3) showed that horses with severe IBH had significantly higher serum IgE concentrations against r-Cul o 1p, r-Cul o 2p, r-Cul o 3, r-Cul n 3, and r-Cul n 4, and sum r-Cul compared to horses without IBH, whereas horses with moderate IBH only had significantly higher IgE against r-Cul o 1p, r-Cul o 6, r-Cul n 9, and sum r-Cul compared to the C group. Horses with severe IBH did not have significantly higher IgE concentrations to any of the tested allergens than horses with moderate IBH.

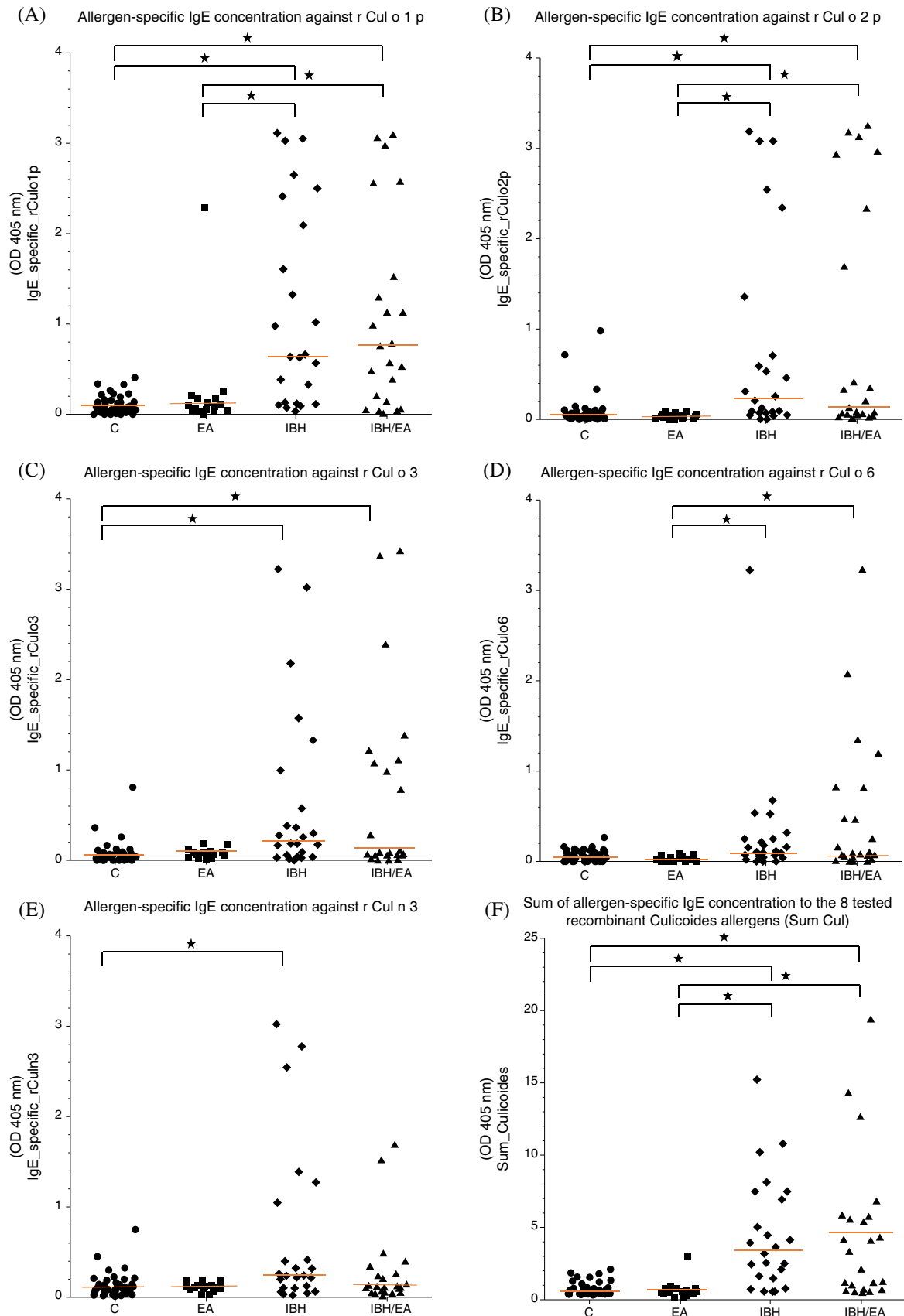

FIGURE 2 Serum immunoglobulin E (IgE) concentrations (presented as optical density [at 405 nm] {OD_{405 nm}}) values) specific for recombinant *Culicoides obsoletus* (Cul o; A-D) or *Culicoides nubeculosus* (Cul n; E) allergens and the sum of Cul o-specific and Cul n-specific IgE (sum Cul; F) in the sera of horses affected with severe equine asthma (group EA), insect bite hypersensitivity (group IBH), or both EA and IBH (group IBH/EA) and in healthy control horses (group C). Each dot represents the value of a single horse, and the red lines representing the median. * indicates significant differences among the groups in the Kruskal-Wallis Multiple-Comparison Z-Value test (Dunn's test) with Bonferroni correction

TABLE 3 Results of allergen-specific IgE concentrations in horses sera

Allergens	Healthy horses (N = 22)	Moderate IBH (1-3) (N = 23)	Severe IBH (4-5) (N = 24)	P-value 1-way ANOVA
r Cul o 1P	0.081 ^{a,b} (0.001-0.33)	0.76 ^b (0.033-3.11)	0.65 ^a (0.01-3.061)	<.001
r Cul o 2P	0.051 ^a (0-0.98)	0.084 (0.004-3.13)	0.37 ^a (0.003-3.25)	≤.01
r Cul o 3	0.033 ^a (0-0.81)	0.087 (0-3.43)	0.28 ^a (0-3.223)	≤.001
r Cul o 6	0.055 ^a (0-0.265)	0.096 ^a (0-3.23)	0.11 (0-0.82)	.032
r Cul n 3	0.097 ^a (0.019-0.75)	0.12 (0.022-3.022)	0.24 ^a (0.015-2.78)	.032
r Cul n 4	0.084 ^a (0-0.55)	0.082 (0-1.83)	0.15 ^a (0.027-3.17)	.017
r Cul n 5	0.068 (0-0.37)	0.104 (0-2.67)	0.078 (0-0.68)	NS
r Cul n 9	0.069 ^a (0-0.69)	0.17 ^a (0-3.35)	0.081 (0.006-1.051)	.024
Sum <i>Culicoides</i>	0.65 ^{a,b} (0.33-2.11)	3.18 ^b (0.49-19.41)	3.75 ^a (0.54-12.66)	.001
r Asp f 4	0.048 (0-0.33)	0.049 (0-0.29)	0.025 (0-0.13)	NS
r Asp f 6	0.16 (0-0.55)	0.17 (0-0.74)	0.12 (0-0.558)	NS
r Asp f 7	0.036 (0-0.23)	0.023 (0-0.36)	0.029 (0-0.2)	NS
r Asp f 8	0.057 (0-0.36)	0.067 (0-1.41)	0.049 (0-1.3)	NS
r Cla h 8	0 (0-0.18)	0 (0-0.18)	0 (0-0.044)	NS
Sum molds	0.28 (0.022-0.99)	0.36 (0.11-1.93)	0.31 (0.051-1.84)	NS
r Der p 23	0.058 (0-0.21)	0.035 (0-0.742)	0.061 (0-0.72)	NS
r Gly d 2	0.095 (0-0.33)	0.095 (0.004-0.69)	0.15 (0.007-0.32)	NS
Sum mites	0.15 (0-0.5)	0.13 (0.004-0.904)	0.24 (0.038-0.93)	NS
Total IgE	6.88 (0-63.13)	10.92 (0-147.74)	12.07 (0-56.62)	NS
Sum IgE-specific	1.35 ^{a,b} (0.43-2.86)	3.68 ^b (0.97-20.67)	4.14 ^a (0.84-13.97)	<.001

Abbreviations: IBH, insect bite hypersensitivity; IgE, immunoglobulin E; NS: nonsignificant; r Asp f, recombinant *Aspergillus fumigatus*; r Cla h, recombinant *Cladosporium herbarum*; r Cul n, recombinant *Culicoides nubeculosus*; r Cul o, recombinant *Culicoides obsoletus*; r Der p, recombinant *Dermatophagoides pteronyssinus*; r Gly d, recombinant *Glycophagus domesticus*.

Horses were grouped depending on the IBH severity grade. Median OD₄₀₅ (range) of IgE levels in sera of horses affected with moderate (IBH score 1-3) or severe (IBH score 4-5) IBH and in healthy control horses. The analysis was performed with sera of the horses from the study by Lanz et al (2017).² Same superscript letters indicate statistically significant differences ($P \leq .05$) in Kruskal-Wallis Z-value test.

4 | DISCUSSION

The major findings of our study are that horses affected both with IBH and EA do not have higher IgE concentrations to any of the tested r-allergens, compared to horses affected with IBH only or with EA only, whereas horses with IBH had significantly higher IgE concentrations against r-*Culicoides* allergens than horses without this condition, independently of a concomitant affection with EA. Contrarily, the presence or absence of EA did not influence these IgE concentrations (Table 2, Supporting Information Table S2). Our findings confirm previous studies,^{22,25,26} which demonstrate that IBH-affected horses have increased IgE concentrations against r-*Culicoides* allergens. However, the impact of additional hypersensitivity disease on serum IgE concentrations in horses has so far not been investigated. In line with previous studies, IBH-affected horses display individual IgE-binding patterns to r-*Culicoides* allergens.²¹ For some allergens, only a few horses with IBH had increased serum IgE concentrations (eg, to r-Cul o 6 and r-Cul n 3), whereas for other allergens such as r-Cul o 1p, a majority had increased specific IgE concentrations. Horses in group EA, with the exception of 1 individual (Figure 2), were not sensitized to r *Culicoides* allergens. Conversely to earlier studies,^{13,14,27} we did not find increased IgE concentrations specific for the 2 r Asp f allergens, r-Asp f 7 and r-Asp f 8, in the EA-affected group. Surprisingly, group IBH/EA had significantly lower r-Asp f 7-specific IgE than groups EA and C. We cannot explain these results, but the IgE concentrations against r-Asp f 7 were extremely low in all groups;

therefore, this finding is probably not biologically relevant (Supporting Information Figure S1A). The difference of our findings to these previous studies might be because of the different horse populations and possibly also environmental factors, that is, exposure to moldy hay. Furthermore, in a previous study,¹³ the horses were all living in the same stable, that is, environmental effects were more homogenous than in the present study. Although IgE concentrations to r-Asp f 7 were very low in all tested samples, a few horses in groups IBH (n = 2) and IBH/EA (n = 3) had high r-Asp f 8-specific IgE in their sera (OD₄₀₅ > 0.5; Supporting Information Figure S1B). This could be explained by the development of IgE autoimmunity, as described in severe allergic diseases in human patients. The presence of autoimmune reactions against phylogenetically highly conserved intracellular proteins such as the ribosomal P2 protein have been described in severe atopic diseases and is the result of cross-reactivity.¹⁹ r-Asp f 8 is a ribosomal P2 protein from *A. fumigatus*. Human patients with severe allergic bronchopulmonary aspergillosis have high serum IgE concentrations and positive skin tests both to *A. fumigatus* ribosomal protein P2 and to its human counterpart.¹⁹ As these cytoplasmic proteins are unlikely to be accessible for antigen-antibody interactions under normal circumstances, this leads to the hypothesis that IgE autoreactivity could be a consequence of tissue damage and release of autoantigens at the site of inflammation. Indeed, skin integrity is often markedly compromised in IBH, which would favor this pathophysiological mechanism.¹⁹

Testing of novel, commercially available r-allergens from molds and mites not previously investigated in the horse did not indicate that they are relevant for EA or IBH. The limited number of potential allergens for EA tested is certainly a limitation of this exploratory part of our study. More efficient methods such as allergen chip arrays, which allow for testing hundreds of allergens simultaneously, should be used in the future for such purposes.²⁸ To further test whether equine multiple hypersensitivity disorder was not associated with a higher IgE response, total serum IgE concentrations were then determined in the sera of EA/IBH-affected horses in comparison to IBH-affected horses and the corresponding healthy controls. Again, no significant differences between the EA/IBH and IBH groups were found. Total IgE concentrations were not determined in the sera from the horses derived from the 2 oldest studies^{16,17} because of these negative results and because previous studies had demonstrated that RAO-affected horses do not have significantly different total IgE concentrations than control horses.²⁴ The high variation of IgE concentrations in the sera of the tested horses, independent of the clinical diagnosis, suggests that these horses were probably infected to varying degrees with endoparasites. Parasite infection increases total serum IgE concentrations in the horse as in other species.²⁹ Unfortunately, no data on endoparasite infestation were available for the horses included in our study. And thus the data on total IgE should be interpreted with caution.

IBH severity can affect *Culicoides*-specific IgE reactivity.⁸ In the present study, horses suffering from severe IBH have, compared to healthy controls, significantly increased IgE concentrations to more r-*Culicoides* allergens (5 allergens) compared to horses with moderate IBH that only had significantly higher IgE to 3 r-*Culicoides* allergens. Nevertheless, no significant differences in allergen-specific IgE concentrations between horses with severe and moderate IBH were found (Table 3). This could be because the IBH score was based on the most severe clinical signs the horse had experienced in life and not on the IBH severity at the time of blood sampling. Furthermore, contrarily to the C group, where the variance of *Culicoides* r-allergens was low, the variance was much higher in the moderate and severe IBH groups (ie, in both IBH groups, horses with high IgE levels to *Culicoides* r-allergens were found). Given this large variation in the affected horses and the moderate numbers in these groups, insufficient power may have led to type II errors, that is, failure to detect differences between groups of moderate and severe IBH. Most IBH horses were protected from insect bites by blankets or use of repellents. This reduced exposure to the causative allergens likely resulted in a decrease of specific IgE concentrations. Interestingly, only the horses with moderate but not with severe IBH had significantly higher IgE to r-Cul o 6 and r-Cul n 9 compared to controls. This might indicate differences in the allergic skin response depending on the allergen to which an individual is sensitized. However, this finding would need to be confirmed in a larger set of horses. The allergens r-Cul o 6 and r-Cul n 9 both belong to the D7 protein family, expressed in salivary glands of Diptera. They have been shown to bind serotonin, histamine, and norepinephrine and thus antagonize platelet aggregation, vascular contraction, and pain.³⁰ The fact that sera were drawn from 3 different studies, which was because of the availability of the IBH/EA group (a valuable collection of rare multiple hypersensitivity phenotypes), which had to be complemented by a severe EA group,

entails several limitations and potential pitfalls. This includes potential confounders regarding case and group definitions, as well as bias through differences in allergen exposure between the groups that were compared. The potential confounder by differences in exposure is already discussed above, specifically regarding comparisons with studies using more homogenous exposure conditions.¹³ However, the 3 studies^{2,16,17} from which samples were used were all performed in the same restricted geographical area of central and Western Switzerland within a 10-year period. Thus, relevant differences in allergen exposure between the populations used in our study are unlikely. Furthermore, although the serum samples originated from horses from 3 different studies, the same questionnaire was consistently used in all horses, specifically the well-validated HOARSI classification as well as thorough clinical and complementary examinations. Importantly, assessment for occurrence of other hypersensitivity diseases such as IBH or recurrent urticaria was performed in all 3 studies (Supporting Information Table S1).¹⁶⁻¹⁸

In conclusion, our study shows that r-*Culicoides*-specific serum IgE in IBH is not associated with concurrent severe EA. Thus, the clinically documented increased risk of IBH horses to develop severe EA does not seem to be influenced by a concomitant increase in total or allergen-specific IgE concentrations. Further studies using a larger panel of r-allergens, for example, by using an allergen chip array and larger numbers of horses to reduce type 2 errors are warranted.

ACKNOWLEDGMENTS

We thank Jelena Mirkovitch and Shui Ling Chu, Department of Clinical Research-VPH, Vetsuisse Faculty, University of Bern, for their help in the laboratory. We also thank Shannon Axiak for her help with preparation of the manuscript and Dr. A.D. Wilson, University of Bristol, for providing reagents for the total serum IgE ELISA.

CONFLICT OF INTEREST DECLARATION

Authors declare no conflict of interest.

OFF-LABEL ANTIMICROBIAL DECLARATION

Authors declare no off-label use of antimicrobials.

INSTITUTIONAL ANIMAL CARE AND USE COMMITTEE (IACUC) OR OTHER APPROVAL DECLARATION

Authors declare no IACUC or other approval was needed.

HUMAN ETHICS APPROVAL DECLARATION

Authors declare human ethics approval was not needed for this study.

ORCID

Maëva Verdon  <https://orcid.org/0000-0001-7950-1331>

Simone Lanz  <https://orcid.org/0000-0003-2453-1829>

Claudio Rhyner  <https://orcid.org/0000-0002-7557-9171>

Vinzenz Gerber  <https://orcid.org/0000-0002-7834-4482>

Eliane Marti  <https://orcid.org/0000-0003-1284-4350>

REFERENCES

- Kehrli D, Jandova V, Fey K, et al. Multiple hypersensitivities including recurrent airway obstruction, insect bite hypersensitivity, and urticaria in 2 warmblood horse populations. *J Vet Intern Med.* 2015;29:320-326.
- Lanz S, Brunner A, Graubner C, et al. Insect bite hypersensitivity in horses is associated with airway hyperreactivity. *J Vet Intern Med.* 2017;31:1877-1883.
- Bantz S, Zuh Z, Zheng T. The atopic march: progression from atopic dermatitis to allergic rhinitis and asthma. *J Clin Cell Immunol.* 2014;5:202. <https://doi.org/10.4172/2155-9899.1000202>.
- Platt M, Howell S, Sachdeva R, Dumont C. Allergen cross-reactivity in allergic rhinitis and oral-allergy syndrome: a bioinformatic protein sequence analysis. *Int Forum Allergy Rhinol.* 2014;4:559-564.
- Schaffartzik A, Hamza E, Janda J, et al. Equine insect bite hypersensitivity: what do we know? *Vet Immunol Immunopathol.* 2012;147:113-126.
- Redlich CA, Herrick CA. Lung/skin connections in occupational lung disease. *Curr Opin Allergy Clin Immunol.* 2008;8:115-119.
- van der Meide NM, Roders N, Sloet van Oldruitenborgh-Oosterbaan MM, et al. Cloning and expression of candidate allergens from *Culicoides obsoletus* for diagnosis of insect bite hypersensitivity in horses. *Vet Immunol Immunopathol.* 2013;153:227-239.
- Peeters LM, Janssens S, Goddeeris BM, et al. Evaluation of an IgE ELISA with *Culicoides* spp. extracts and recombinant salivary antigens for diagnosis of insect bite hypersensitivity in Warmblood horses. *Vet J.* 2013;198:141-147.
- Frey R, Bergvall K, Egenvall A. Allergen-specific IgE in Icelandic horses with insect bite hypersensitivity and healthy controls, assessed by FcεR1α-based serology. *Vet Immunol Immunopathol.* 2008;126:102-109.
- Couëtil LL, Cardwell JM, Gerber V, et al. Inflammatory airway disease of horses-revised consensus statement. *J Vet Intern Med.* 2016;30:503-515.
- Pirie RS. Recurrent airway obstruction: a review. *Equine Vet J.* 2014;46:276-288.
- Leclere M, Lavoie-Lamoureux A, Lavoie JP. Heaves, an asthma-like disease of horses. *Respirology.* 2011;16:1027-1046.
- Künzle F, Gerber V, Van Der Haegen A, et al. IgE-bearing cells in bronchoalveolar lavage fluid and allergen-specific IgE levels in sera from RAO-affected horses. *J Vet Med A Physiol Pathol Clin Med.* 2007;54:40-47.
- Eder C, Cramer R, Mayer C, et al. Allergen-specific IgE levels against crude mould and storage mite extracts and recombinant mould allergens in sera from horses affected with chronic bronchitis. *Vet Immunol Immunopathol.* 2000;73:241-253.
- Schmallenbach KH, Rahman I, Sasse HHL, et al. Studies on pulmonary and systemic *Aspergillus fumigatus*-specific IgE and IgG antibodies in horses affected with chronic obstructive pulmonary disease (COPD). *Vet Immunol Immunopathol.* 1998;66:245-256.
- Rettmer H, Hoffman AM, Lanz S, et al. Owner-reported coughing and nasal discharge are associated with clinical findings, arterial oxygen tension, mucus score and bronchoprovocation in horses with recurrent airway obstruction in a field setting. *Equine Vet J.* 2015;47:291-295.
- Laumen E, Doherr MG, Gerber V. Relationship of horse owner assessed respiratory signs index to characteristics of recurrent airway obstruction in two Warmblood families. *Equine Vet J.* 2010;42:142-148.
- Ramseyer A, Gaillard C, Burger D, et al. Effects of genetic and environmental factors on chronic lower airway disease in horses. *J Vet Intern Med.* 2007;21:149-156.
- Mayer C, Appenzeller U, Seelbach H, et al. Humoral and cell-mediated autoimmune reactions to human acidic ribosomal P2 protein in individuals sensitized to *Aspergillus fumigatus* P2 protein. *J Exp Med.* 1999;189:1507-1512.
- Cramer R. Recombinant *Aspergillus fumigatus* allergens: from the nucleotide sequences to clinical applications. *Int Arch Allergy Immunol.* 1998;115:99-114.
- Schaffartzik A, Marti E, Torsteinsdottir S, et al. Selective cloning, characterization, and production of the *Culicoides nubeculosus* salivary gland allergen repertoire associated with equine insect bite hypersensitivity. *Vet Immunol Immunopathol.* 2011;139:200-209.
- Jonsdottir S, Hamza E, Janda J, et al. Developing a preventive immunization approach against insect bite hypersensitivity using recombinant allergens: a pilot study. *Vet Immunol Immunopathol.* 2015;166:8-21.
- Wilson AD, Harwood L, Torsteinsdottir S, et al. Production of monoclonal antibodies specific for native equine IgE and their application to monitor total serum IgE responses in Icelandic and non-Icelandic horses with insect bite dermal hypersensitivity. *Vet Immunol Immunopathol.* 2006;112:156-170.
- Scharrenberg A, Gerber V, Swinburne JE, et al. IgE, IgGa, IgGb and IgG(T) serum antibody levels in offspring of two sires affected with equine recurrent airway obstruction. *Anim Genet.* 2010;41:131-137.
- Jonsdottir S, Svansson V, Stefansdottir SB, et al. A preventive immunization approach against insect bite hypersensitivity: intralymphatic injection with recombinant allergens in alum or alum and monophosphoryl lipid A. *Vet Immunol Immunopathol.* 2016;172:14-20.
- Ziegler A, Hamza E, Jonsdottir S, et al. Longitudinal analysis of allergen-specific IgE and IgG subclasses as potential predictors of insect bite hypersensitivity following first exposure to *Culicoides* in Icelandic horses. *Vet Dermatol.* 2018;29:51-e22.
- Niedzwiez A, Jaworski Z, Kubiak K. Serum concentrations of allergen-specific IgE in horses with equine recurrent airway obstruction and healthy controls assessed by ELISA. *Vet Clin Pathol.* 2015;44:391-396.
- Marti E, Wang X, Jambari NN, et al. Novel in vitro diagnosis of equine allergies using a protein array and mathematical modelling approach: a proof of concept using insect bite hypersensitivity. *Vet Immunol Immunopathol.* 2015;167:171-177.
- Hamza E, Wagner B, Jungi TW, et al. Reduced incidence of insect-bite hypersensitivity in Icelandic horses is associated with a down-regulation of interleukin-4 by interleukin-10 and transforming growth factor-β1. *Vet Immunol Immunopathol.* 2008;122:65-75.
- Calvo E, Mans Ben J, Andersen John F, Ribeiro José MC. Function and evolution of a mosquito salivary protein family. *J Biol Chem.* 2006;281:1935-1942.

SUPPORTING INFORMATION

Additional supporting information may be found online in the Supporting Information section at the end of the article.

How to cite this article: Verdon M, Lanz S, Rhyner C, Gerber V, Marti E. Allergen-specific immunoglobulin E in sera of horses affected with insect bite hypersensitivity, severe equine asthma or both conditions. *J Vet Intern Med.* 2019;33:266-274. <https://doi.org/10.1111/jvim.15355>