

---

# Clinical Chemistry through *Clinical Chemistry*: A Journal Timeline

ROBERT REJ

---

The establishment of the modern discipline of clinical chemistry was concurrent with the foundation of the journal *Clinical Chemistry* and that of the American Association for Clinical Chemistry in the late 1940s and early 1950s. To mark the 50th volume of this Journal, I chronicle and highlight scientific milestones, and those within the discipline, as documented in the pages of *Clinical Chemistry*. Amazing progress has been made in the field of laboratory diagnostics over these five decades, in many cases paralleling—as well as being bolstered by—the rapid pace in the development of computer technologies. Specific areas of laboratory medicine particularly well represented in *Clinical Chemistry* include lipids, endocrinology, protein markers, quality of laboratory measurements, molecular diagnostics, and general advances in methodology and instrumentation.  
© 2004 American Association for Clinical Chemistry

This year, *Clinical Chemistry* turned 50 (1). Our 50th volume continues to do what we have done best each year since Volume 1—to present the latest developments in medical laboratory technology, applications, and practices. However, in tribute to our semicentenary, we would be remiss, as we close the year, if we did not also reflect on this Journal's published achievements over the past five decades. Having a journal title that is eponymous with the field that it covers can be the cause of

some confusion; at times, even we involved in its production refer to it as “Clinical Chemistry Journal”. However, the two entities are intertwined, and in a not insignificant way, the Journal has helped to define the field over the past five decades. We are, of course, not the only publication that covers the discipline, and many important developments and advances have been published in other periodicals. Still others appeared in the realm of intellectual property through patents.

In this overview, I have selected numerous highlights and representative articles illustrating advances in the practice of clinical chemistry as they appeared in the pages of this Journal, and I have placed them in historical perspective by juxtaposing them with contemporaneous events in the broader world. I was guided by both the citation frequency of papers that had significant impact and opportunities that a paper provided to exemplify developments in technology, instrumentation, and medicine of the day. This journal timeline is not intended to be a detailed history of the Journal, as many facets of our heritage have already been reported (2–12).

In reviewing nearly 100 000 pages of the journal, I was again struck by how much has changed, yet how much has remained the same (1). Over the years, many papers were devoted to general topics still very much of interest to our readers today: lipids, endocrinology, protein markers, quality of results, and advances in methodology. Of course, much has also gone the way of high-button shoes and 5¢ coffee, such as thymol flocculation tests and measurement of protein-bound iodine. The development of the field of laboratory diagnostics can be seen in tracing the evolution of figures within papers, from the large number of photographs and hand-drawn diagrams of glassware that were characteristic of the first years of publication to displays of results from

---

Laboratory of Molecular Diagnostics, Wadsworth Center for Laboratories and Research, New York State Department of Health, Albany, NY, and Department of Biomedical Sciences, School of Public Health, State University of New York, Albany, NY.

\*Address for correspondence. Laboratory of Molecular Diagnostics, Wadsworth Center for Laboratories and Research, New York State Department of Health, Albany, NY 12201-0509. Fax 518-474-9185; e-mail bob@wadsworth.org.

Received September 10, 2004; accepted September 13, 2004.

Previously published online at DOI: 10.1373/clinchem.2004.042820

devices, rather than the devices themselves. I was occasionally amused by the now-quaint spellings of "technic" and "computer", as well as the liberal use of the plural "serums". The AACC annual meeting played a central role over the years, with names of speakers, award-ees, and their abstracts and biographies printed as regular or supplemental pages. Review of those entries will help to further document the interesting topics of the day, as well as to uncover such—today politically incorrect—entries as "ladies programs". Those days, however, also boasted hotel rooms with daily rates of \$7.50 in Santa Monica and \$8.50 in Boston; "charming" pictures of meeting venues also graced our pages.

Many of today's efforts at standardization and harmonization were more than foreshadowed in several seminal papers appearing in this Journal during the 1960s and 1970s; perhaps if more attention had been paid to these papers when they were published three or four decades ago, current standardization efforts might not be so necessary, or at least not so difficult and costly in their implementation. Another theme that often appeared was the role of the profession of medical laboratorians and relationships among professional societies; some of the rhetoric makes for more-than-interesting reading that borders on voyeurism. The give and take in correspondence regarding various view points on the various issues of the day (13) also seemed to contain far more spleen than the tamer exchanges that are encountered today. Nonetheless, it betrays an enthusiasm that can be admired whichever side one might have supported.

I was also struck by the specific "personality" of the journal under each of its three editors as it evolved and developed. Although they appeared on our mastheads under differing titles, their role clearly match that of "Editor-in-Chief" in other publishing circles. It may be happenstance that their tenures were contemporaneous with reasonably defined advances and achievements in the field: "Managing Editor" Appleton (1955–1969) with the period establishing the discipline as we know it today and with the automation of classical chemistry procedures; "Executive Editor" King (1970–1990) coincided with advances in immunoassay, computer-assisted techniques, and new instrumentation; and our current adjectiveless "Editor" Bruns (1991–) has been coeval with applications of molecular biology and evidence-based medicine. The journal has benefited greatly from the occupancy of the Editor's chair by these three; a history of the Journal's leadership appears elsewhere (12).

Another theme that emerged in my review was the rapidity with which clinically useful procedures put major scientific discoveries to use. There are many methods and clinical applications described in our pages that swiftly followed the publication of major biomedical findings (many of which led to Nobel Prizes). The first research papers describing the structure of hemoglobins, immunoassays, HPLC, GC/MS, monoclonal antibodies, PCR, MS/MS, etc. were followed in very short order by a multitude of applications of the knowledge in our pages.

Predicting the future is tricky business. In 1967, a US Senate Subcommittee reportedly heard testimony forecasting that, by 1985, Americans would work 22 hours each week, 27 weeks a year, or that they would retire at age 38 (14). If only that had come to pass! On the other hand, some true visionaries got it just about right. "I have not been reading science fiction," wrote David Seligson in 1962, on the future of clinical chemistry in these pages (15). He continues:

The time will come when blood is sent from a hospital to a large receiving center—that is, a laboratory which does large numbers of special analyses automatically and continually, day and night, weekends and holidays . . . special instruments can sort, analyze, punch out answers, and return reports. Even the latter, the report, will probably disappear in our new way of life because we shall have instruments which identify samples, analyze them, and electronically enter the result into a computer. The latter could be as much as 100 miles away. . . . Our laboratory instruments will feed the data into the computer and the computer will convert it to a final report and store the information.

A physician who wishes to know the electrolyte values for his patient will not call the laboratory, he will tell the computer what he wants and the computer will direct a typewriter which will give him the information at the rate of 1000 lines per minute. The same information can be requested 10 times in one hour without irritating the laboratory secretaries or anyone else. Furthermore, the laboratory will also have a computer outlet so that serial data on any patient can be observed for fluctuations. The clinical chemist will be able to get any information he needs in seconds without going to his own files or to the record room. There will be no useless files or the wasted effort of unnecessary searches. The computer will not lose data; the intern will not carry the precious report in his pocket where no one can find it. The computer will serve the laboratory in other ways too. It will provide automatic programs and will turn on and off the machines of the laboratory. It will digitalize data and provide direct readout of final answers. It will provide a new dimension for the clinical chemist.

Pretty remarkable insight, considering not all that much in the way of automation existed in medical laboratories four decades ago and that there were only 15 computers in the entire US in 1955, just 7 years before his commentary was written. Admittedly, these prescient comments are rather atypical for our pages; the Journal has generally been filled with factual and useful information that advances our knowledge and profession in an incremental fashion. I was both rather surprised and more than slightly disappointed that there was precious little in the way of extravagant or, even better, dystopic, predictions of "clinical chemistry of the future" to regale the readers of this overview.

As predicted by Seligson over 40 years ago (15), computers have had a powerful role in clinical chemistry, as in most other disciplines. As we look back on 50 years of articles, the advances in laboratory medicine in many ways parallel the spectacular achievements in the semiconductor and computer fields: ever faster/better/cheaper. In the last decade, computers and the Internet have played a dominant role in the dissemination of scientific information. Our Journal was one of the first to embrace these technologies, and it went "online" in 1998 with full content available back to 1997. Abstracts of articles also were accessible for the period 1975–1996, and authors and titles of articles were listed for the period 1965–1974. This too will change. In the very near future, the full content of *Clinical Chemistry*, from Volume 1, page 1 up to the current issue will be made available online. With this occurrence of a totally electronic version, I take a fair degree of gratification in imagining that I may well be the last person to have browsed through all 50 years of *Clinical Chemistry* in its 200-kg paper incarnation (Fig. 1). Although librarians, and atavists of all ages, may bemoan the eventual demise of the medium of choice for the past few hundred years, I shall not be among them. This project has more than reinforced my leanings toward the obsolescence of a very inefficient vehicle for communicating data, ideas, and information. The hundreds of decaying, amber-colored pages that I reviewed also challenge the idea that electronic is ephemeral and that paper is permanent.

Although large parts of the world remain technologically unconnected, I am confident that access to all of the information in our pages will be facilitated in those regions as a result of these initiatives. Obtaining the paper copy of this, and other, journals is still impossible in many laboratories around the globe.



Fig. 1. The author with about a decade's worth of *Clinical Chemistry*.

Although Internet access may not be universal, access to the electronic version will be far easier—and less expensive—than is access to the print copy. This Journal, and others, have shown their commitment to wide dissemination of the information in their pages by making content available without charge to institutions in developing countries (16, 17).

The sightings of cyber cafés in remote regions of the planet attest to the view that access to information will be increasingly electronic. In many respects, an even greater "digital divide" exists regarding access to the older literature; if information is not available electronically, it is often ignored. Review of the past 50 years of this journal has underscored for me the importance of the fact that every advance is based on the findings of previous work. Many today may think that use of mass spectrometry for newborn screening is a relatively new application, but this use was already described in 1972 (18). With the electronic republication of the first four decades of *Clinical Chemistry*, access to many of the seminal articles in the field will be instantly available to all readers.

I hope that the sampling from the Journal in this timeline will inform, and occasionally amuse, and that you will be persuaded to explore the vast archive that is scheduled to be available at your desktop early in 2005.

*Like as the waves make towards the pebbled shore,  
So do our min hasten to their end;  
Each changing place with that which goes before,  
In sequent toil all forwards do contend.*



# 1955

*Vol. 1, number 1.* AACC establishes a bimonthly scientific journal—*Clinical Chemistry*—“to raise the level at which chemistry is practiced in the clinical laboratory; to stimulate the development of new methods for use in the clinical laboratory; to encourage those engaged in this field to pursue advanced studies so as more effectively to render service to the public; and to create and maintain a forum where clinical chemists may exchange ideas and information concerning their scientific, technical and professional problems.” The first volume comprises some 430 pages.

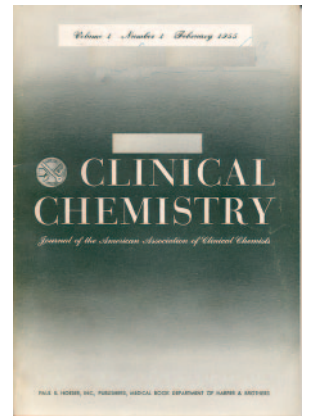

*Mediterranean diet and blood lipids.* A multinational study of the effects of diet on serum lipid concentrations suggests the benefits of a Mediterranean diet. The authors understatedly—but correctly—infer that the mechanisms by which diet affects blood lipids “must be complex”. Keys A, et al. Effects on diets on blood lipids in man: particularly cholesterol and lipoproteins. *Clin Chem* 1955;1:34–52.

*Serum lipids and atherosclerosis.* A variety of techniques, including ultracentrifugation, chemical treatment, and electrophoresis, are applied to separate serum lipoproteins. “Their distinctive patterns are correlated with . . .

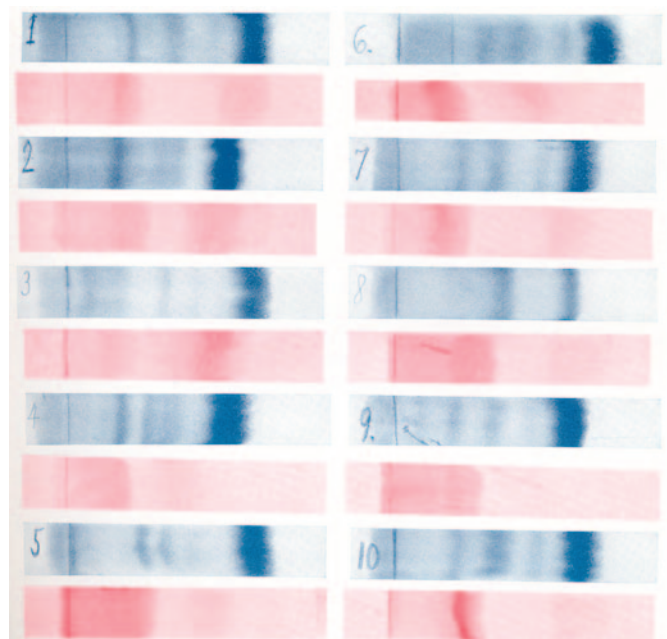

atherosclerosis". Adlersberg D, et al. Electrophoresis and monomolecular layer studies with serum lipoproteins. *Clin Chem* 1955;1:18–33. Brown RK, et al. Serum lipoproteins: chemical and enzymatic studies. *Clin Chem* 1955;1:83–92.

**Blood gases measured in 0.1 mL.** Blood gas measurements are made even on sample from a fingertip puncture. Natelson S, Menning CM. Improved methods of analysis for oxygen, carbon monoxide, and iron on fingertip blood. *Clin Chem* 1955;1:165–79. Singer RB, et al. Simultaneous determination of pH, CO<sub>2</sub> content, and cell volume in 0.1 mL aliquots of cutaneous blood: a modification of the Shock and Hastings technic. *Clin Chem* 1955;1:287–316.

**Reference material for hemoglobin.** A standard reference material is proposed for hemoglobin measurements. Materials, prepared by Dr. David Drabkin will be "distributed without charge to clinical laboratories". Cannan RK. Proposal of the distribution of a certified standard for use in hemoglobinometry. *Clin Chem* 1955;1:151–6.

Total income of AACC for 1955 is \$7464.20; membership stands at 629 (*Clin Chem* 1955;1:422–4)

Severo Ochoa at NYU synthesizes DNA- and RNA-like molecules.  
Deaths of Albert Einstein and Alexander Fleming.  
The polio vaccine, developed by Jonas Salk, is declared safe for use. Just three years earlier, the disease had stricken over 50 000 in the US.

**1956** The role of serum lipoproteins in atherogenesis is at an early stage of development, and new analytical tools are described. The analytical variation of the newly described methods is said to be lower than "spontaneous intraindividual variability". Anderson JT, et al. Cholesterol in serum and lipoprotein fractions: its measurement and stability. *Clin Chem* 1956;2:145–59.

Carr JJ, Dreker IJ. Simplified rapid technic for the extraction and determination of serum cholesterol without saponification. *Clin Chem* 1956;2:353–68.

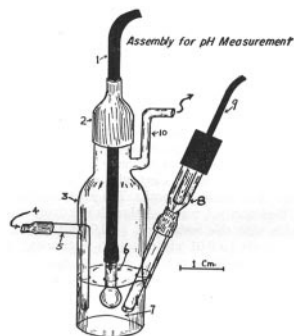

**Not exactly stat.** Blood pH determinations are suggested to be made by collecting the specimen under mineral oil, cooling to room temperature,

and performing the determination under oil on the separated serum. Natelson S, Tietz N. Blood pH measurement with the glass electrode: study of venous and fingertip blood. *Clin Chem* 1956;2:320–7.

**And we think that CLIA'88 limits are too broad.** An international external quality control/proficiency survey organized by IFCC reveals that laboratory results for one specimen exceed ranges of 90 to 142 mmol/L for sodium and 90 to 170 mg/dL for glucose. Distribution of materials "calibrated for the content of various constituents by suitable reference laboratories" is suggested as a mechanism to improve quality of laboratory results. Wootton IDP. International biochemical trial 1954. *Clin Chem* 1956;2:296–301.

**Paper tiger.** Serum proteins can be separated and quantified by paper electrophoresis. Laurell CB, et al. Buffer composition in paper electrophoresis: considerations on its influence, with special reference to the interaction between small ions and proteins. *Clin Chem* 1956;2:99–111. Wurm M, Epstein FH. Quantitative electrophoresis of serum proteins on paper. *Clin Chem* 1956;2:303–19.

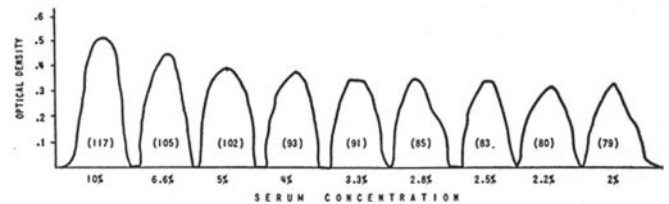

A tube-air extractor allows superior measurement of urinary estrogens. Five extractions, each of 45 min, are required. Anker RM. Urinary estrogens in pregnancy: improved method for their determination in humans. *Clin Chem* 1956;2:184–7.

**Price fixing?** A pricing structure of \$60 per month per physician for unlimited laboratory testing is criticized for having the potential to mass-produce analyses and to lead to work of poor quality as well as the temptation to over-order unneeded tests. *Clin Chem* 1956;2:453–4.

AACC Hosts the International Congress on Clinical Chemistry, 9–14 September 1956, in New York, and *Clinical Chemistry* publishes the abstracts (*Clin Chem* 1956;2:225–95 and 383–93). Hot topics of the day: spectrophotofluorometry—a new tool at the submicrogram level; fractionation of lipoprotein cholesterol by paper electrophoresis; standardization; application of enzymes to the measurement of glucose. Leonard

Skeggs introduces a “flowing stream” automatic analyzer “allowing 20 to 30 analyses per hour”.

Dwight D. Eisenhower reelected US president.  
 First transatlantic telephone cable goes into service.  
 AACC annual dues to be raised to \$12.50.  
 The first computer disk memory system (IBM 305 RAMAC); a stack of 50 two-foot diameter disks can store just over 4 MB.

**1957** *Less is more.* A flurry of published activity on reducing sample size: micro and ultra-micro methods are reported for numerous analytes. The unit “ $\mu\text{L}$ ”, however, is used sparingly. Sanz MC. Ultramicro methods and standardizations of equipment. *Clin Chem* 1957;3:406–19. Carpenter KJ, et al. Estimation of total cholesterol in serum by a micro method. *Clin Chem* 1957;3:233–8. Stoner RE, Weisberg HF. Ultramicro method for serum bilirubin by diazo blue reaction. *Clin Chem* 1957;3:22–36. Kingsley GR, Getchell G. Test tube extraction method for the microdetermination of urinary 17-ketosteroids. *Clin Chem* 1957;3:624–31. Galloway LS, et al. Micro determination of cholesterol by use of 0.04 mL of serum blood. *Clin Chem* 1957;3:226–32.

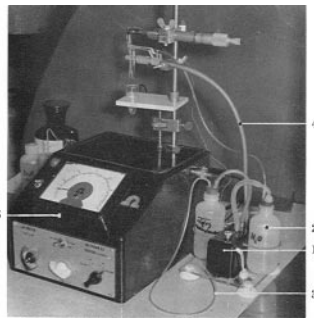
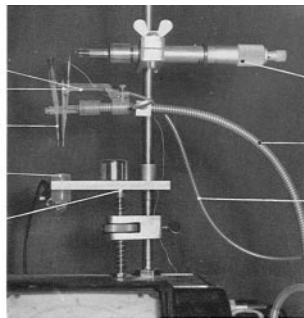

*QC for me.* “[It] seems very likely that many more laboratories will organize their own systems of quality control within their own walls. There is also every indication that more countries are about to commence schemes of issuing certified samples”. Wootton ID. Standardization in clinical chemistry. *Clin Chem* 1957;3:401–5.

*Dry with a twist.* The first routine application of reagents in a dry chemistry strip also introduces an enzyme catalyzed reaction: glucose oxidase replaces the widespread alkaline copper reduction test. Free AH, et al. Simple specific test for urine glucose. *Clin Chem* 1957;3:163–8.

*My Hb.* Less than a decade after Pauling discovered the nature of the heterogeneity of hemoglobins, a routine electrophoretic method is published for the identification of six human hemoglobins. Goldberg CA. Identification of human hemoglobins. *Clin Chem* 1957;3:1–19. Huisman TH. The properties, estimation methods, hematologic features, and some other more general aspects of different abnormal human hemoglobins. *Clin Chem* 1957;3:371–93.

*Cl & CF.* The electrical conductivity of sweat is shown to be a sensitive and specific test for identification of patients with cystic fibrosis. Licht TS, et al. Measurement of the electrical conductivity of sweat: its application to the study of cystic fibrosis of the pancreas. *Clin Chem* 1957;3:37–48.

Quantitative methods for the routine analysis of 17-ketosteroids and catecholamines. Kafka MS, Bondy PK. Total neutral 17-ketosteroids: clinical method for measurement. *Clin Chem* 1957;3:178–84. Gray I, Young JG. Epinephrine and norepinephrine concentrations in plasma of human and rats. *Clin Chem* 1957;3:239–48.

The Soviet Union launches Sputnik, Earth’s first man-made space satellite; the Space Race begins.  
 Leonard Bernstein’s *West Side Story* debuts.  
 Smith-Corona makes a portable electric typewriter; it weighs over 18 pounds.

**1958** A sensitive fluorometric assay for plasma corticosteroids is developed. Silber RH, et al. Practical procedure for estimation of corticosterone and hydrocortisone. *Clin Chem* 1958;4:278–85.

*Enzymes.* Practical photometric procedures appear. Houchin OB. A rapid colorimetric method for the quantitative determination of copper oxidase activity (ceruloplasmin). *Clin Chem* 1958;4:519–23. Lazaroni JA. The stability of lactic dehydrogenase in serum. *Clin Chem* 1958;4:379–81. Schneider AJ, Willis MJ. Sources of variation in a standardized and a semimicro procedure for the spectrophotometric assay of serum glutamic-oxalacetic transaminase concentration. *Clin Chem* 1958;4:392–408. Sheperd HG, McDonald HJ. Electrophoretic migration pattern of serum glutamic oxalacetic transaminase. *Clin Chem* 1958;4:13–21.

*Dawn of automation.* “THE CLINICAL CHEMIST in charge of a routine biochemistry laboratory appears to be faced with an insoluble dilemma. At a time when there is an increasing demand from the medical profession for more biochemical tests per patient, which

would seem to require the use of microprocedures, he finds it almost impossible to obtain personnel with the requisite technical skill. One way out of this dilemma would appear to be the use of completely automatic technics . . . the use of this kind of automation would solve the problem . . . in the larger laboratories". Saifer A, et al. Rapid system of microchemical analysis for the clinical laboratory. *Clin Chem* 1958;4:127–41.

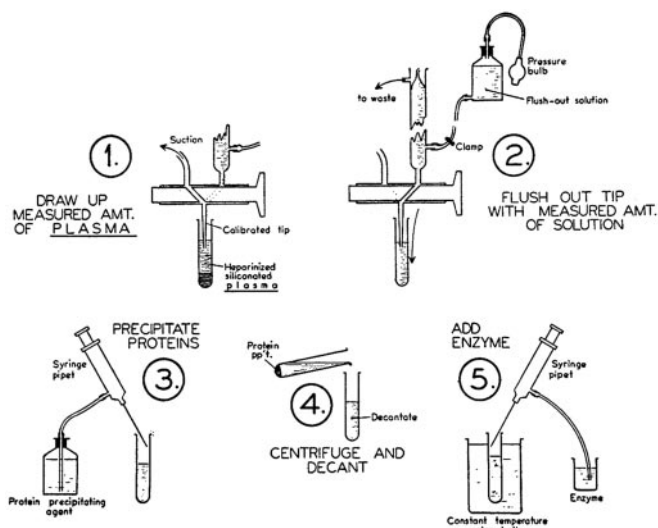

**Simple in 1958!** Serum ethanol is measured by a procedure requiring steam distillation of 5 mL of blood, followed by reaction with dichromate for 45 min at 103 °C. Mather A. A simple determination of blood alcohol for the clinical laboratory. *Clin Chem* 1958;4:223–310.

**Elementary.** Laboratory capabilities for essential and toxic elements expand. Bachra BN, et al. The complexometric titration of micro and ultramicro quantities of calcium in blood serum, urine, and inorganic salt solutions. *Clin Chem* 1958;4:107–19. Zak B, Ressler N. Serum copper and iron on a single sample. *Clin Chem* 1958;4:43–8. Seligson D, et al. Electrometric method for the determination of chloride in serum and other biological fluids. *Clin Chem* 1958;4:159–69. Nobel S, Nobel D. Determination of mercury in urine. *Clin Chem* 1958;4:150–8.

China begins its "Great Leap Forward" modernization program.  
First transatlantic jet passenger service is started by BOAC, New York to London.  
The Advanced Research Projects Agency (ARPA) is established.  
The European Economic Community (EEC) is established.

**1959** *Folic acid is measured in serum by using Lactobacillus casei.* Baker H, et al. A microbiological method for detecting folic acid deficiency in man. *Clin Chem* 1959;5:275–80.

**Enzymes as markers.** Progress is made in use of enzymes as markers of human disease. Marsh WH, et al. Adaptation of an alkaline phosphatase method for automatic colorimetric analysis. *Clin Chem* 1959;5:119–26. Bowers GN. Measurement of isocitric dehydrogenase activity in body fluids. *Clin Chem* 1959;5:509–18.

Filter paper is used as a sample collection medium and applied to the measurement of phenylalanine, glucose, galactose, and other substances in samples from newborns. Berry HK. Procedures for testing urine specimens dried on filter paper. *Clin Chem* 1959;5:603–8.

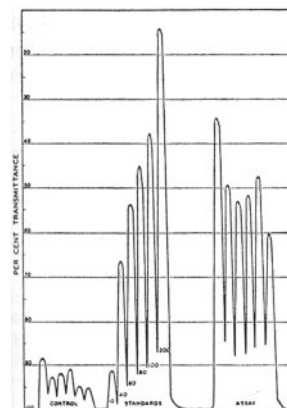

**Microchemistry.** New systems are developed aimed at automation and reducing sample size. Klein B. A system of clinical chemical analysis. *Clin Chem* 1959;5:62–70. Seligson D. A system of microchemistry for the hospital laboratory designed for maintenance of a high standard of performance. *Clin Chem* 1959;5:320–34.

**Cholesterol and age.** Serum cholesterol shown to increase with age. Ackermann PG, et al. Blood lipids in young and old individuals. *Clin Chem* 1959;5:100–5.

**Epinephrine and norepinephrine are quantified in blood specimens.** Keenan MP, et al. The determination of catechol amines in blood. *Clin Chem* 1959;5:239–47.

AACC membership increases by 11% to 830, with members now in 46 of the 49 states. *Clin Chem* 1959;5:162–3.

**Clinical Chemistry at a crossroads.** The role of laboratory professionals and their accreditation and licensure are reviewed, and a position paper is issued; licensure is advocated as the "quality of laboratory service being



rendered . . . is often poor and at times dangerous". *Clin Chem* 1959;5:250-4;636-40.

American scientists patent the computer chip. Cuban President Batista resigns, and Fidel Castro assumes power. The first plain-paper copier is manufactured: the Xerox 914. Alaska and Hawaii became the USA's 49th and 50th states.

**1960** *Little yellow pills.* Within a few years after chlorpromazine was cleared by the FDA as the first antipsychotic drug to be marketed in the US, procedures for the detection of this and other drugs were developed. A simple visual test for detection of antipsychotic drugs is stated to detect drug use for several weeks after administration. Sobolewski G, Nadeau G. A scheme for the rapid identification in urine of commonly used sedatives, hypnotics, and tranquilizers. *Clin Chem* 1960;6:153-61. Forrest IS, Forrest FM. Urine color test for the detection of phenothiazine compounds. *Clin Chem* 1960;6:11-5.

*RNase.* A method for ribonuclease offers a detection limit of 1 ng. Correlations with disease states are established. Levy AL, Rottino A. Effect of disease states on the ribonuclease concentration of body fluids. *Clin Chem* 1960;6:43-51.

*Protein method for glassblowers.* Density gradient electrophoresis separates serum proteins without denaturation. Colehour JK. Separation of serum proteins by density gradient electrophoresis. *Clin Chem* 1960;6:485-94.

*Lightly starched.* Sensitive and rapid methods for amylase are described, and the reaction is characterized. Somogyi M. Modifications of two methods for the assay of amylase. *Clin Chem* 1960;6:23-35. Henry RJ, Chiamori N. Study of the saccharogenic method for the determination of serum and urine amylase. *Clin Chem* 1960;6:434-52. Marsters RW, et al. A micromethod for the determination of plasma amylase. *Clin Chem* 1960;6:130-9.

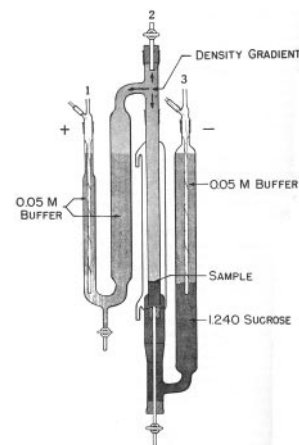



**On steroids.** New methods are more rapid and require less sample for the quantification of steroids. Rappaport F, et al. A rapid method for the estimation of urinary 17-ketosteroids. *Clin Chem* 1960;6:16–22. Dingman JF, et al. Glass-fiber paper chromatography of adrenal and gonadal steroids. *Clin Chem* 1960;6:228–32.

**Take one and call in the morning.** Reagents for the determination of alkaline phosphatase are commercially available in a single stabilized tablet (PhosphaTABS). Klein B, et al. Rapid method for the quantitative determination of serum alkaline phosphatase. *Clin Chem* 1960;6:269–75.

**Dawn of the nuclear age.** Gaebler OH, et al. Study of the determination of heavy water in plasma or urine. *Clin Chem* 1960;6:549–57. Natelson S, et al. X-ray spectroscopy in the clinical laboratory. *Clin Chem* 1960;6:299–313.

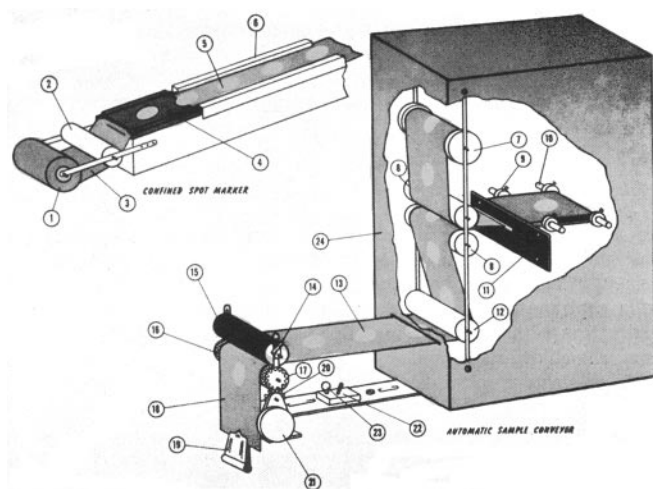

The first working laser is built by T.H. Maiman. Senegal, Ghana, Nigeria, Madagascar, and Zaire (Belgian Congo) gain independence. The precursor to the minicomputer: DEC introduces the PDP-1. It includes a cathode ray tube graphic display, requires only one operator, and costs \$120 000. The CRT intrigued early hackers at MIT, who wrote the first computerized video game: *SpaceWar!* It's still available: <http://lcs.www.media.mit.edu/groups/el/projects/spacewar/>

**1961** **Acid/Base.** Further advances are made in the determination of blood gases and electrolytes. Astrup P. A new approach to acid-base metabolism. *Clin Chem* 1961;7:1–15. Hendry EB. Osmolarity of human

serum and of chemical solutions of biological importance. *Clin Chem* 1961;7:156–64. Reinhold JG, Chung CC. Formation of artifactual ammonia in blood by action of alkali: its significance for the measurement of blood ammonia. *Clin Chem* 1961;7:54–69.

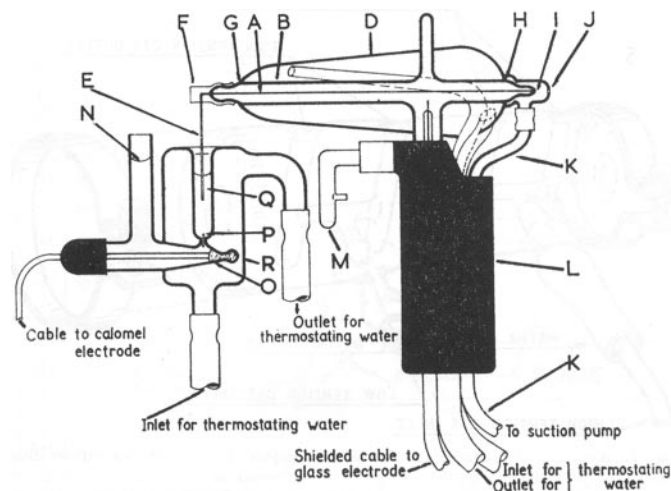

**Lipids rise with faster analyses, smaller sample sizes.** Specimens stored on filter paper are first used as samples. Van Handel E. Suggested modifications of the micro determination of triglycerides. *Clin Chem* 1961;7:249–51. Mann GV. A method of measurement of cholesterol in blood serum. *Clin Chem* 1961;7:275–84. Connerty HV, Briggs AR, Easton EH. Simplified determination of the lipid components of blood serum. *Clin Chem* 1961;7:37–53.

Abstracts make their appearance in the Journal at the start of each article rather than as a final "Summary" as in earlier volumes.

The roles of the laboratorian and the status of the profession of clinical chemistry were covered extensively in the first 10 volumes of the Journal. Volume 7 had more than its share of coverage, and readers interested in the topics of concern of the day are directed to *Clin Chem* 1961;7:75–91;303–7;421–2 for a comprehensive overview.

**Move over Dr. Karmen.** The "International Unit" is born as the preferred manner for expressing catalytic activity of enzymes (*Clin Chem* 1961;7:199).

**Serum as a "standard"?** *Say it isn't so.* The role of reference materials in the calibration and quality control of laboratory assays is examined. Calibration using serum-based materials is criticized as substituting "compensation" for reliability. Klugerman MR, Bout-



**1963** *Not another enzyme method!* Lipase measurement by turbidimetry decreases analysis time from 3 h to 20 min. Vogel WC, Zieve L. A rapid and sensitive turbidimetric method for serum lipase based upon differences between the lipases of normal and pancreatitis serum. *Clin Chem* 1963;9:168-81.

*Tonks' formula.* The quality of laboratory testing is examined by use of an approach based on biological variability. Tonks proposes the formula, which will eventually become eponymous, that analytical variability should be less than 25% of biological variability ("1/4 of the normal range"). According to this criterion, more than 40% of 4762 results obtained in an interlaboratory survey are considered unacceptable. Tonks DB. A study of the accuracy and precision of clinical chemistry determinations in 170 Canadian laboratories. *Clin Chem* 1963;9:217-33.

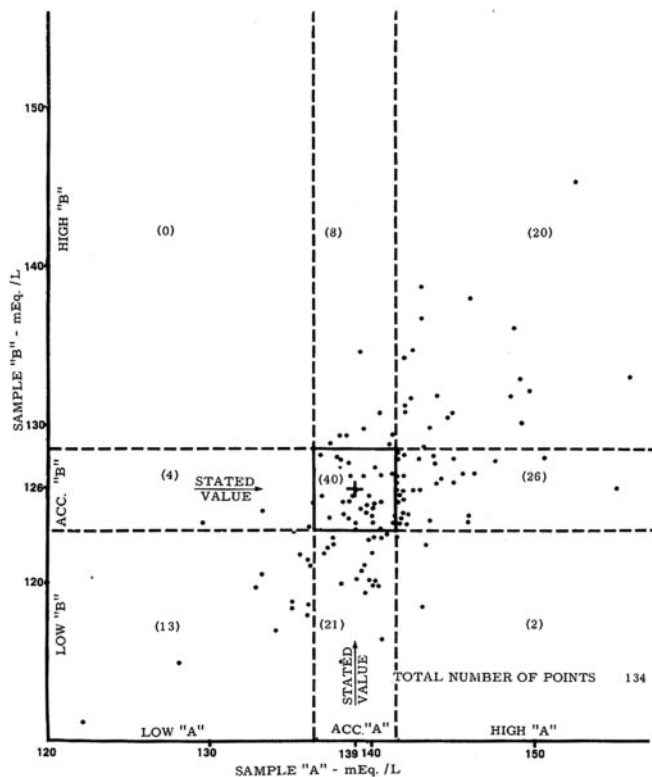

*More on urea.* Diacetyl monoxime is used to quantify urea. Coulombe JJ, Favreau L. A new simple semimicro method for colorimetric determination of urea. *Clin Chem* 1963;9:102-8.

*PBI was a high-volume test.* Protein-bound iodine assays are automated. Stevens CO, Levandoski NG. Automation of protein-bound iodine determination. *Clin Chem* 1963;9:400-7. Benotti J, Benotti N. Protein-bound io-

dine, total iodine, and butanol-extractable iodine by partial automation. *Clin Chem* 1963;9:406-16.

*Clinical Chemistry to appear monthly.* The price of subscriptions to the Journal will be increased by \$2.00 per year to \$8.00 per year to cover anticipated increases in expenses with proposed monthly publication. Julius Sendroy is elected to chair of the Board of Editors as Harold Appleton was named to the new position of Managing Editor (*Clin Chem* 1963;9:640-2).

Washington-to-Moscow "hot line" communications link opens, designed to reduce risk of accidental war.  
 US President Kennedy is shot and killed by a sniper in Dallas; Lyndon B. Johnson becomes President the same day.  
 There are 15 000 US military advisers in South Vietnam.  
 The first "push-button" telephones are introduced.

**1964** *Simultaneous automation.* The first multichannel analyzer to perform eight determinations simultaneously is described. The analyzer records directly on calibrated paper, providing an "immediately usable form". One operator can perform 960 individual tests per day, equal to the output expected per person in a month with manual techniques. Skeggs LT, Hochstrasser H. Multiple automatic sequential analysis. *Clin Chem* 1964;10:918-36.

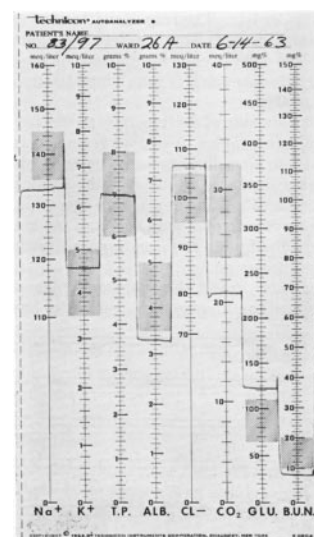
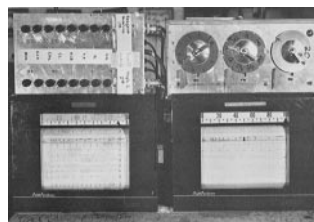

*Calcium and phosphorus: a completely automated flow system.* Kessler G, Wolfman G. An automated procedure for the simultaneous determination of calcium and phosphorous. *Clin Chem* 1964;10:686-703.

Tyrosine and phenylalanine method helps to identify newborns with phenylketonuria Wong P, et al. Micro-methods for measuring phenylalanine and tyrosine in serum. *Clin Chem* 1964;10:1098–104.

*Let the cards fall where they may.* A notched card system organizes reprints. Over 800 key words can be used. Weissman N. A punched-card reference system for biochemists. *Clin Chem* 1964;10:214–23.

**Calcium.** Atomic absorption spectroscopy is applied to determination of serum calcium. The method is claimed to be the “method of choice”. Zettner A, Seligson D. Application of atomic absorption spectrophotometry in the determination of calcium in serum. *Clin Chem* 1964;10:869–90.

**Pumping iron.** Few laboratories measure iron and iron binding capacity, as methods have been too complicated for routine use and the insensitivity of the chromogen produces unacceptable imprecision. A new method makes the test practical and accessible. Fischer DS, Price DC. A simple serum iron method using the new sensitive chromogen tripyridyl-*s*-triazine. *Clin Chem* 1964;10:21–31.

**E for effort.** A new procedure for routine assay of vitamin E is published, and reference values are established. Martinek RG. Method for the determination of vitamin E (total tocopherols) in serum. *Clin Chem* 1964;10:1078–86.

**This is fast?** The Journal changes to monthly format and, “[can] achieve publication within 6–7 months after acceptance”. Circulation at 4615. (*Clin Chem* 1964; 10:1153).

Nelson Mandela is sentenced to life imprisonment in South Africa.

Martin Luther King, Jr., is awarded the Nobel Peace Prize.

Kurtz and Kemeny create the BASIC programming language at Dartmouth College.

Birth of the cubicle: designers at Herman Miller build prototypes of the “Action Office” freestanding units.

**1965** *Not just bubbles.* Many tests are adapted to the continuous-flow AutoAnalyzer, but the first automated discrete analyzer is also introduced: the “Robot Chemist”. Morgenstern S, et al. An automated *p*-nitrophenylphosphate serum alkaline phosphatase procedure for the “robot chemist”. *Clin Chem* 1965;11:

889–97. Morgenstern S, et al. An automated *p*-nitrophenylphosphate serum alkaline phosphatase procedure for the autoanalyzer. *Clin Chem* 1965;11:876–88. Marsch WH, et al. Automated and manual direct methods for the determination of blood urea. *Clin Chem* 1965;11:624–7. Robinson RL, Watts DT. An automated trihydroxyindole procedure for the differential analysis of catecholamines. *Clin Chem* 1965;11:986–97. Hill JB, et al. An automated procedure for blood phenylalanine. *Clin Chem* 1965;11:541–6.

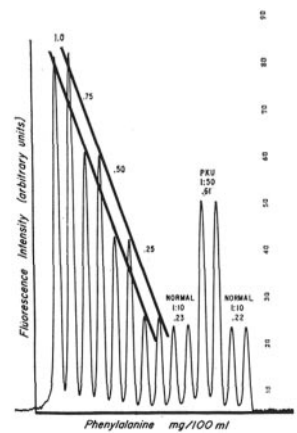

Fluorometry is applied to several analytes. Brooks L, Olken HG. An automated fluorometric method for determination of lactic dehydrogenase in serum. *Clin Chem* 1965;11:748–62. Hill JB. Automated fluorometric method for determination of serum calcium. *Clin Chem* 1965;11:122–30. Sax SM, Moore JJ. Fluorometric measurement of creatine kinase activity. *Clin Chem* 1965;11: 951–8.

**Cholinesterase.** A practical method is developed, suitable for screening of patients before anesthesia or after exposure to organophosphates or nerve gas. Garry PJ, Routh JI. A micro method for serum cholinesterase. *Clin Chem* 1965;11:91–6.

A punch card system for the storage and retrieval of laboratory data is described. A day’s results required 2000 cards, which were processed in batches at the end of the day. Nonetheless, introduction of the system reduced the turnaround time by 2 h. Peacock AC, et al. Data processing in clinical chemistry. *Clin Chem* 1965; 11:595–611.

CHEMISTRY REQUESTS		JONES J SMITH		4018		10/16/64	
DO NOT WRITE ABOVE THIS LINE		DO NOT WRITE ABOVE THIS LINE		DO NOT WRITE ABOVE THIS LINE		DO NOT WRITE ABOVE THIS LINE	
PATIENT NAME AND NUMBER	JONES, JOHN J.	74444	64.11.07-22-35	EW	4018	Acid Phosphatase	Fasting
TYPE OF SPECIMEN	URIC ACID	ALBUMIN	CHOLESTEROL	GLUCOSE	SODIUM	POTASSIUM	OTHER TEST
1	MAGNESIUM	TRIGL	TURBIDITY	AMYLASE	CHLORIDE	CARBON DIOXIDE	INSTRUCTIONS
2	CALCIUM	BSP	LACTIC DEHYDROGENASE	PHOSPHORUS	UROBILINOGEN	CORTICOSTEROIDS (URINE)	OTHER TEST
3	PHOSPHORUS	ALKALINE PHOSPHATASE	BILIRUBIN TOTAL	BILIRUBIN IMIN	SGP TRANSAMINASE	SGO TRANSAMINASE	PROTEIN, TOTAL
4	INSTRUCTIONS AND REMARKS	4018	Acid Phosphatase	Fasting	7:30 AM	10/16/64	A.R. Smith
5	MARK ONE ONLY	1	2	3	4	5	6
6	7	8	9	10	11	12	13
14	15	16	17	18	19	20	21
22	23	24	25	26	27	28	29
30	31	32	33	34	35	36	37
38	39	40	41	42	43	44	45
46	47	48	49	50	51	52	53
54	55	56	57	58	59	60	61
62	63	64	65	66	67	68	69
70	71	72	73	74	75	76	77
78	79	80	81	82	83	84	85
86	87	88	89	90	91	92	93
94	95	96	97	98	99	100	101
102	103	104	105	106	107	108	109
110	111	112	113	114	115	116	117
118	119	120	121	122	123	124	125
126	127	128	129	130	131	132	133
134	135	136	137	138	139	140	141
142	143	144	145	146	147	148	149
150	151	152	153	154	155	156	157
158	159	160	161	162	163	164	165
166	167	168	169	170	171	172	173
174	175	176	177	178	179	180	181
182	183	184	185	186	187	188	189
190	191	192	193	194	195	196	197
198	199	200	201	202	203	204	205
206	207	208	209	210	211	212	213
214	215	216	217	218	219	220	221
222	223	224	225	226	227	228	229
230	231	232	233	234	235	236	237
238	239	240	241	242	243	244	245
246	247	248	249	250	251	252	253
254	255	256	257	258	259	260	261
262	263	264	265	266	267	268	269
270	271	272	273	274	275	276	277
278	279	280	281	282	283	284	285
286	287	288	289	290	291	292	293
294	295	296	297	298	299	300	301
302	303	304	305	306	307	308	309
310	311	312	313	314	315	316	317
318	319	320	321	322	323	324	325
326	327	328	329	330	331	332	333
334	335	336	337	338	339	340	341
342	343	344	345	346	347	348	349
350	351	352	353	354	355	356	357
358	359	360	361	362	363	364	365
366	367	368	369	370	371	372	373
374	375	376	377	378	379	380	381
382	383	384	385	386	387	388	389
390	391	392	393	394	395	396	397
398	399	400	401	402	403	404	405
406	407	408	409	410	411	412	413
414	415	416	417	418	419	420	421
422	423	424	425	426	427	428	429
430	431	432	433	434	435	436	437
438	439	440	441	442	443	444	445
446	447	448	449	450	451	452	453
454	455	456	457	458	459	460	461
462	463	464	465	466	467	468	469
470	471	472	473	474	475	476	477
478	479	480	481	482	483	484	485
486	487	488	489	490	491	492	493
494	495	496	497	498	499	500	501
502	503	504	505	506	507	508	509
510	511	512	513	514	515	516	517
518	519	520	521	522	523	524	525
526	527	528	529	530	531	532	533
534	535	536	537	538	539	540	541
542	543	544	545	546	547	548	549
550	551	552	553	554	555	556	557
558	559	560	561	562	563	564	565
566	567	568	569	570	571	572	573
574	575	576	577	578	579	580	581
582	583	584	585	586	587	588	589
590	591	592	593	594	595	596	597
598	599	600	601	602	603	604	605
606	607	608	609	610	611	612	613
614	615	616	617	618	619	620	621
622	623	624	625	626	627	628	629
630	631	632	633	634	635	636	637
638	639	640	641	642	643	644	645
646	647	648	649	650	651	652	653
654	655	656	657	658	659	660	661
662	663	664	665	666	667	668	669
670	671	672	673	674	675	676	677
678	679	680	681	682	683	684	685
686	687	688	689	690	691	692	693
694	695	696	697	698	699	700	701
702	703	704	705	706	707	708	709
710	711	712	713	714	715	716	717
718	719	720	721	722	723	724	725
726	727	728	729	730	731	732	733
734	735	736	737	738	739	740	741
742	743	744	745	746	747	748	749
750	751	752	753	754	755	756	757
758	759	760	761	762	763	764	765
766	767	768	769	770	771	772	773
774	775	776	777	778	779	780	781
782	783	784	785	786	787	788	789
790	791	792	793	794	795	796	797
798	799	800	801	802	803	804	805
806	807	808	809	810	811	812	813
814	815	816	817	818	819	820	821
822	823	824	825	826	827	828	829
830	831	832	833	834	835	836	837
838	839	840	841	842	843	844	845
846	847	848	849	850	851	852	853
854	855	856	857	858	859	860	861
862	863	864	865	866	867	868	869
870	871	872	873	874	875	876	877
878	879	880	881	882	883	884	885
886	887	888	889	890	891	892	893
894	895	896	897	898	899	900	901
902	903	904	905	906	907	908	909
910	911	912	913	914	915	916	917
918	919	920	921	922	923	924	925
926	927	928	929	930	931	932	933
934	935	936	937	938	939	940	941
942	943	944	945	946	947	948	949
950	951	952	953	954	955	956	957
958	959	960	961	962	963	964	965
966	967	968	969	970	971	972	973
974	975	976	977	978	979	980	981
982	983	984	985	986	987	988	989
990	991	992	993	994	995	996	997
998	999	1000					

DA. A new method for the continuous monitoring of blood glucose by measurement of dissolved oxygen. *Clin Chem* 1965;11:869–75.

Electrophoresis on cellulose acetate membranes is used to separate serum proteins, providing better resolution in less time. Kaplan A, Savory J. Evaluation of a cellulose acetate electrophoresis system for serum protein fractionation. *Clin Chem* 1965;11:937–42.

The miniskirt, designed by Mary Quant, appears in London, soon to be all the rage.

Rhodesia unilaterally declares its independence from Britain.

Gordon Moore notes that the number of transistors per chip doubles every 18–24 months.

**1966** *Gee, see.* Gas-liquid chromatography is used for rapid, quantitative, sensitive measurements. Kroman HS, et al. Estrogens in human pregnancy plasma. I. studies with gas chromatography. *Clin Chem* 1966;12:670–80. Berrett CR, McNeil C. The quantitation of major 17-ketosteroid fraction by gas-liquid chromatography. *Clin Chem* 1966;12:399–405. Savory J, Kaplan A. A gas chromatographic method for determination of lactic acid in blood. *Clin Chem* 1966;12:559–69.

*Profiles in serum.* The biochemical profile is born. Multichannel analyzers allow 10 simultaneous determinations on <1 mL of serum at a rate of 60 specimens per hour. Results appear on five two-pen recorders. "A very high level of preventive maintenance is required continuously." Acceptance by physicians is "enthusiastic". Thiers RE, et al. A multichannel continuous flow analyzer. *Clin Chem* 1966;12:120–36. Bryan DJ, et al. Profile of admission chemical data by multichannel automation: an evaluative experiment. *Clin Chem* 1966;12:137–43.

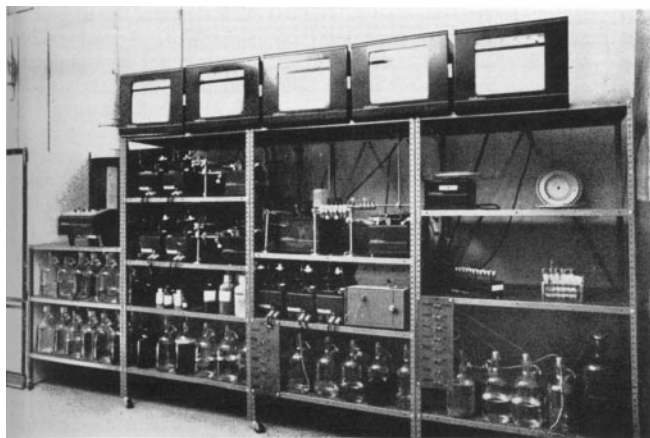

Assays of enzymes, isoenzymes and enzymatic analyses become more routine. Bowers GN, McComb RB. A continuous spectrophotometric method for measuring the activity of serum alkaline phosphatase. *Clin Chem* 1966;12:70–89. Morgenstern S, et al. Automated determination of serum glutamic oxaloacetic transaminase. *Clin Chem* 1966;12:95–111. Rosenberg JC, Rush BF. An enzymatic-spectrophotometric determination of pyruvic and lactic acid in blood. *Clin Chem* 1966;12:299–307. Babson AL, et al. Phenolphthalein monophosphate as a substrate for serum alkaline phosphatase. *Clin Chem* 1966;12:482–90. Bergerman J. Determination of LDH isoenzymes. *Clin Chem* 1966;12:797–802.

*Van Slyke.* Donald D. Van Slyke was awarded the National Medal of Science by President Lyndon B. Johnson. The citation recognized his work as a pioneer in "the exact science of clinical chemistry, a specialized branch of biochemistry, represented by a profession whose members render most important support to clinicians in the diagnostic and prognostic aspects of their work in treating patients." *Clin Chem* 1966;12:453.



*A slippery slope?* The trend to purchased reagents accelerates; a policy for "Reagent Sets and Kits" is published (*Clin Chem* 1966;12:43–4). The semiautomated pipette is devised. "People with little or no background in laboratory work can make accurate pipettings after a short practice period." Harrison NB. Semiautomated pipetting device (the Governor Pipet) for clinical chemistry procedures. *Clin Chem* 1966;12:890–3

The Great Proletarian Cultural Revolution begins in China.

Metropolitan Opera House opens in Lincoln Center, New York City.

The first episode of the science fiction television series "Star Trek" airs.

**1967** *What is a standard?* A seminal report discussing standards, standardization, reference materials and methods, and definitive methods is published. The report has its origins in the AACC "Committee on Standards and Controls"; many issues are relevant

today. Radin N. What is a standard? *Clin Chem* 1967;13:55–76.

**Continuous monitoring (on paper) when CK was CPK.** Creatine kinase gains acceptance in the diagnosis of disorders affecting skeletal and cardiac muscle. Continuous monitoring of enzyme-catalyzed reactions becomes accepted. Hess JW, et al. Serum creatine phosphokinase: evaluation of a commercial spectrophotometric method. *Clin Chem* 1967;13:994–1005.

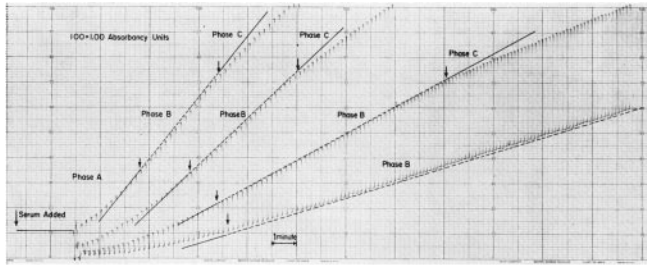

**Coagulation.** Assays for measurement of coagulation factors and compounds affecting coagulation are published. Swaim WR, Feders MB. Fibrinogen assay. *Clin Chem* 1967;13:1026–8. Corn M, Berberich R. Rapid fluorometric assay for plasma warfarin. *Clin Chem* 1967;13:126–31.

**They use enzymes for everything.** Further expansion of enzymes used as reagents, allowing sensitive and specific and rapid assays of metabolic substrates. Marbach EP, Weil MX. Rapid enzymatic measurement of blood lactate and pyruvate; use and significance of metaphosphoric acid as a common precipitant. *Clin Chem* 1967;314–25. Klinenberg JR, et al. An enzymatic spectrophotometric method for the determination of xanthine and hypoxanthine. *Clin Chem* 1967;13:834–46.

*Clinical Chemistry's* circulation reaches 5800 (*Clin Chem* 1967;13:1103).

**CLIA'67 becomes law.** President Lyndon B. Johnson is shown congratulating AACC Executive Director David A.H. Roethel on behalf of clinical chemists on its passage.



Dr. Christiaan N. Barnard and a team of South African surgeons perform the world's first successful human heart transplant. Israeli and Arab forces battle; the "Six-Day War" ends with Israel occupying the Sinai Peninsula, Golan Heights, Gaza Strip, and east bank of the Suez Canal. Sweden switches to right-hand traffic.

**1968** *The nice thing about standards is that there are so many of them.* Reference and control materials for use in clinical laboratories are characterized, and recommendations are made for their appropriate roles. A stable albumin reference preparation for use as a calibrator is described. Peters T Jr. Proposals for standardization of total protein assays. *Clin Chem* 1968;14:1147–59. Young DS, Mears TW. Measurement and standard reference materials in clinical chemistry. *Clin Chem* 1968;14:929–43. Logan JE, Allen RH. Control serum preparations. *Clin Chem* 1968;14:437–48.

**LIMS arrives.** The benefits of a newly implemented laboratory information system include the ability to use punch cards for requisitions and the issuing of patient-summary reports for 12 consecutive days or sets of results. The system was implemented on an IBM 1440 with "a core memory of 8K". Cillo AA. A simplified, economic, working "computer-assisted laboratory information system" (CALIS). *Clin Chem* 1968;14:197–207.



**NMR, GC-MS, HPLC, and URINE.** State-of-the art techniques are applied to the determination of urinary constituents. Dean JA. Use of nuclear magnetic resonance in determining molecular structure of urinary constituents of low molecular weight. *Clin Chem* 1968;14:326–38. Creveling CR, et al. Use of dansyl derivatives and mass spectrometry for identification of biogenic amines. *Clin Chem* 1968;14:302–9. Scott CD. Analysis of urine for its ultraviolet-absorbing constituents by high-pressure anion-exchange chromatography. *Clin Chem* 1968;14:521–8. Burtis CA, Warren KS. Identification of urinary constituents isolated by anion-exchange chromatography. *Clin Chem* 1968;14:290–301.

**Sweet success.** A polarographic rate method is introduced for the routine determination of glucose. Kadish AH, et al. A new and rapid method for the determination of glucose by measurement of rate of oxygen consumption. *Clin Chem* 1968;14:116–31.

**T<sub>4</sub> by column.** Ion exchange is used to measure thyroxine in serum. The procedure obviates drying and ashing of column eluates at 620 °C for an hour. Pileggi VJ, Kessler G. Determination of organic iodine compounds in serum. IV. A new nonincineration technic for serum thyroxine. *Clin Chem* 1968;14:339–47.

**Clinical Laboratory Improvement.** Guidelines for clinical laboratory proficiency are published within months of Congressional approval of CLIA'67. *Clin Chem* 1968;14:91–2 (a form to register your laboratory appears on page 928).

The first cash-dispensing machine is installed by First Philadelphia Bank.  
Assassinations of Martin Luther King, Jr., and Robert F. Kennedy.  
Czechoslovakia is invaded by Soviet and Warsaw Pact forces.

**1969** **More standards.** In this year, it was estimated that over 95% of analyses performed by the clinical laboratory are performed by a colorimetric or spectrophotometric procedure. Standards for ensuring the reliability and reproducibility of these measurements are published. Rand RN. Practical spectrophotometric standards. *Clin Chem* 1969;15:839–63.

**γ-GT and 5'NT complicate printing of acronyms.** Methods for the measurement of γ-glutamyltransferase and 5'-nucleotidase and their clinical application are published. The Szasz procedure for the former remains in widespread use today, after more than three decades. Szasz G. A kinetic photometric method for serum gamma-glutamyl transpeptidase. *Clin Chem* 1969;15:124–36. Belfield A, Goldberg DM. Application of a continuous spectrophotometric assay for 5'-nucleotidase activity in normal subjects and patients with liver and bone disease. *Clin Chem* 1969;15:931–9.

**POC circa 1969 and pre-IRB.** A mobile testing unit for measurement of glucose is described. A 10-foot sampling catheter continuously sampled blood (0.1 mL/min); two peristaltic pumps were used so that if one

failed, the second would prevent reverse flow of reagents into the subject. Rosevear JW, et al. Glucose oxidase method for continuous automated blood glucose determination. *Clin Chem* 1969;15:680–98.

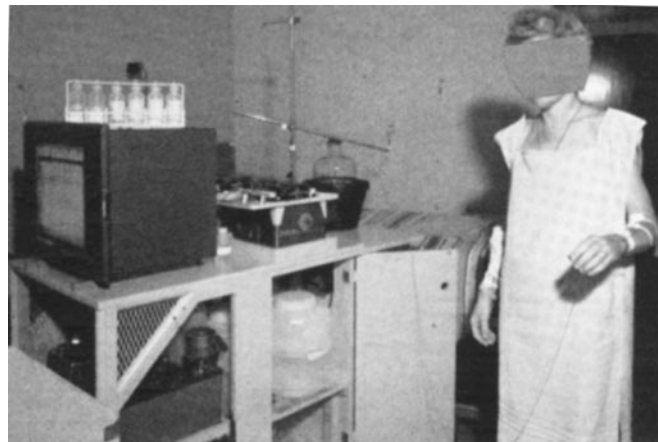

**Drugs in the 60s.** Drugs measurements are made more quantitative and adaptable to clinical samples, allowing determination of interindividual differences in drug metabolism. Pippenger C, Gillen HW. Gas chromatographic analysis for anticonvulsant drugs in biologic fluids. *Clin Chem* 1969;15:582–90. Wallace J. Simultaneous spectrophotometric determination of phenytoin and phenobarbital in biologic specimens. *Clin Chem* 1969;15:323–30.

**A better PBI for the 21st century.** Although methods are available for measurement of thyroxine, improvements are still being made in technologies that would soon be abandoned. The new protein-bound iodine procedure uses only 25 μL of serum, but it requires stepwise drying and ashing at up to 600 °C for several hours. Hordynsky WE, et al. Ultramicromethod for PBI. *Clin Chem* 1969;15:224–9.

The first man walks on the moon.  
Woodstock Music and Art Festival is held at Max Yasgur's dairy farm in Bethel, NY.  
First word processor with a floppy disk appears.  
Kenneth Thompson and Dennis Ritchie develop the UNIX operating system.  
The "Internet" is born: the US Department of Defense established the ARPANET; four nodes are connected by year's end.





internal reference. *Clin Chem* 1970;16:99–1007. Nomoto S, Sunderman FW Jr. Atomic absorption spectrometry of nickel in serum, urine, and other biological materials. *Clin Chem* 1970;16:477–85. Gochman N, Givelber H. Automated, simultaneous microdetermination of calcium and magnesium by atomic absorption. *Clin Chem* 1970;16:229–34. Pybus J, Bowers GN Jr. Measurement of serum lithium by atomic absorption spectroscopy. *Clin Chem* 1970;16:139–43.

**Vitamin A.** A method adaptable to routine analysis is developed for vitamin A. Garry PJ, et al. Plasma vitamin A assay by fluorometry and use of a silicic acid column technique. *Clin Chem* 1970;16:766–72.

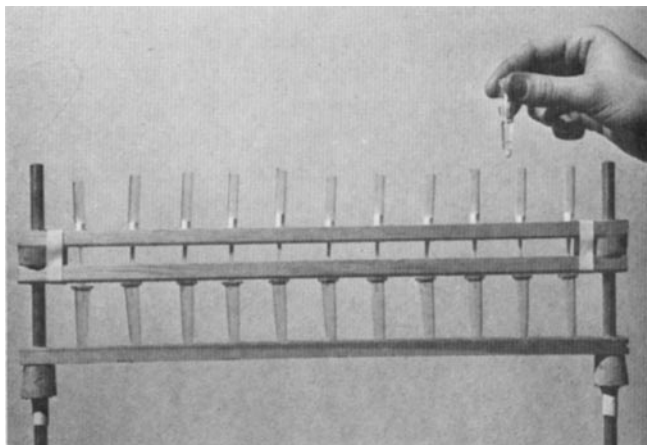

Fibrinogen determination in plasma is published along with reference values. Grannis GF. Plasma fibrinogen: determination, normal values, physiopathologic shifts, and fluctuations. *Clin Chem* 1970;16:486–94.

**Is our face red?** Volume 16 brought several changes in addition to just the new color of the cover. The format increased from  $6\frac{1}{2} \times 10$  inches to its current  $8\frac{1}{4} \times 11\frac{1}{4}$ -inch page size, and we moved from a commercial publisher (Hoeber Medical Division of Harper & Row) as the AACC became its own publisher. J. Stanton King presided over all as newly named Executive Editor. Dr. King also served as AACC Executive Director. Keyphrases are introduced mid-year. Predating Google by over three decades, a fixed-list is avoided as “information is too diverse to be forced successfully into such a Procrustean bed” (*Clin Chem* 1970;16:361).

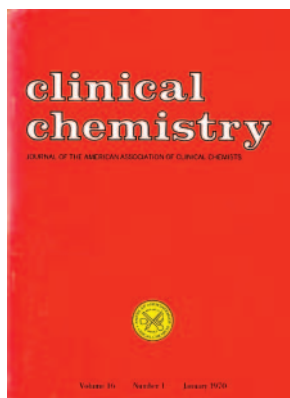

Alexander Solzhenitsyn receives the Nobel Prize for literature.

The Apollo 13 space mission is launched.

The Beatles break up.

**1971** *It's elemental.* Applications of atomic absorption spectroscopy expand to include many additional elements. Matousek JP, Stevens BJ. Biological applications of the carbon rod atomizer in atomic absorption spectroscopy. 1. Preliminary studies on magnesium, iron, copper, lead, and zinc in blood and plasma. *Clin Chem* 1971;17:363–8. Meret S, Henkin RI. Simultaneous direct estimation by atomic absorption spectrophotometry of copper and zinc in serum, urine, and cerebrospinal fluid. *Clin Chem* 1971;17:369–73.

**What is normal?** Further scrutiny of reference intervals is advocated. In particular cases, nonparametric methods are recommended. Reed AH, et al. Influence of statistical method used on the resulting estimate of normal range. *Clin Chem* 1971;17:275–84.

**ALA.** See Burch HB, Siegel AL. Improved method for measurement of delta-aminolevulinic acid dehydratase activity of human erythrocytes. *Clin Chem* 1971;17:1038–41.

**A new spin on analyses.** The centrifugal analyzer is introduced to medical laboratory applications. Immediate reading and following of reaction kinetics make practical the use of rate measurements for analyses that were formerly carried out only as reactions that reached near end-point or equilibrium. Interferences that required deproteinization or other pretreatments were obviated. Fabiny DL, et al. Increased rate of analysis by use of a 42-cuvette GeMSAEC fast analyzer. *Clin Chem* 1971;17:686–95. Tiffany TO, et al. Feasibility of multiple simultaneous enzyme assays, for diagnostic purposes, with the GeMSAEC fast analyzer. *Clin Chem* 1971;17:715–20. Ertingshausen G. Automated reaction-rate method for determination of serum creatinine with the CentriChem. *Clin Chem* 1971;17:696–700.

GC-MS is applied to the measurement of steroids, organic acids, drugs, and drug metabolites in human urine. Horning EC, Horning MG. Metabolic profiles: gas-phase methods for analysis of metabolites. *Clin Chem* 1971;17:802–9.

**Specific proteins.** Automated procedures are developed for the quantitative measurement of serum proteins. Killingsworth LM, Savory J. Automated immuno-

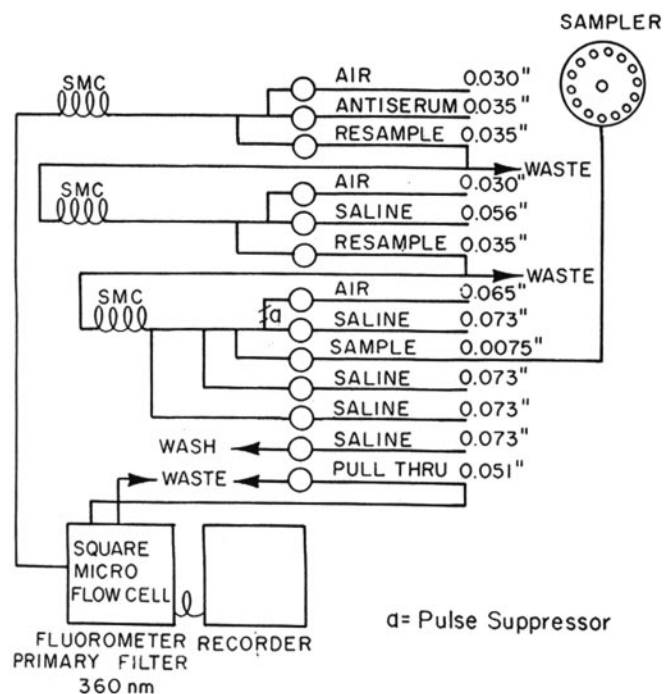

chemical procedures for measurement of immunoglobulins IgG, IgA, and IgM in human serum. *Clin Chem* 1971;17:936-40.

AACC membership is now 2084 (*Clin Chem* 1971;17:1202); D.D. Van Slyke dies at 88 (*Clin Chem* 1971;17:670-2).

UN seats mainland China.  
 E-mail is invented! People communicate over ARPANET, now up to 15 nodes (23 hosts).  
 The first pocket calculator, the Pocketric, is introduced by Texas Instruments. It weighs ~2.5 pounds, costs \$150.00, and can add, subtract, multiply, and divide.  
 Bangladesh is created; East Pakistan and West Pakistan split.  
 The floppy disk is introduced by IBM for computer data storage.

**1972** Thank you Dr. Friedewald—No ultracentrifugation required. For the first time, LDL-cholesterol can be estimated without ultracentrifugation. The estimation uses an equation with terms for triglyceride, HDL-cholesterol, and total cholesterol. This paper will be cited by nearly 7000 other publications over the next 30 years; even improper citations (to "page 449" or to "Freidewald") number >300! Friedewald WT, et al.

Estimation of the concentration of low-density lipoprotein cholesterol in plasma, without use of the preparative ultracentrifuge. *Clin Chem* 1972;18:499-502.

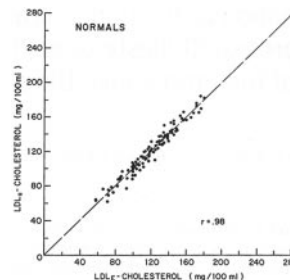

**STOP YELLING!** The first version of Donald Young's compendium on the effects of drugs on laboratory tests appears as a special issue of the Journal. It comprises nearly 300 pages of computer line-printer output, ALL IN UPPERCASE! Young DS, et al. Effects of drugs on clinical laboratory tests. *Clin Chem* 1972;18:1041-303.

**GC-MS applied to inborn errors.** Jellum E, et al. Combined use of gas chromatography, mass spectrometry, and computer in diagnosis and studies of metabolic disorders. *Clin Chem* 1972;18:800-9.

**More new methods.** Method for the determination of serum or urinary proline are described and applied to cases of proline oxidase deficiency. Goodwin JF. Spectrophotometry of proline in plasma and urine. *Clin Chem* 1972;18:1041-303.

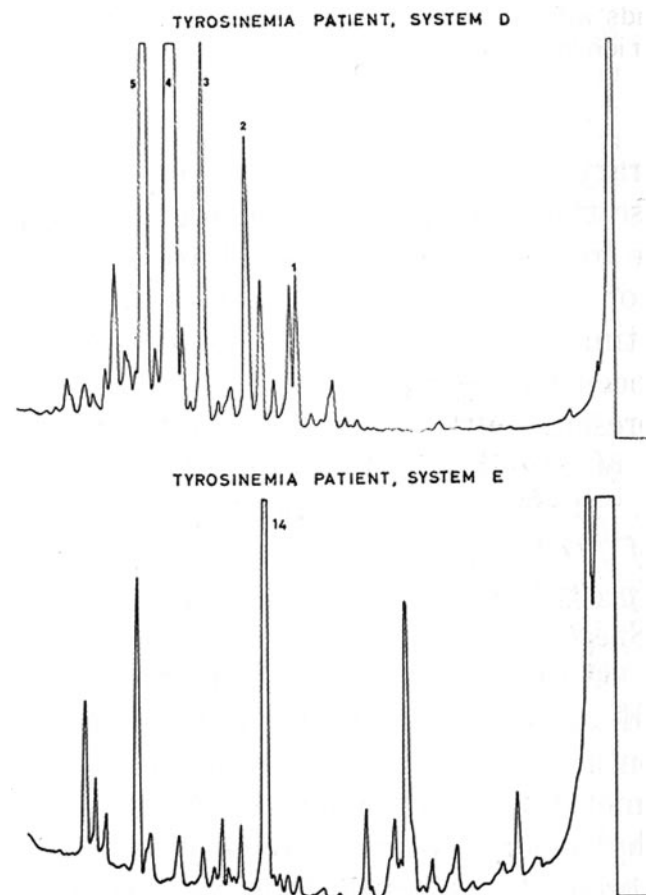

*Chem* 1972;18:449–53. An assay for dopamine-hydroxylase is devised and applied to catecholamine metabolism. Nagatsu T, Udenfriend S. Photometric assay of dopamine-hydroxylase activity in human blood. *Clin Chem* 1972;18:980–3. Assays for cyanide and thiocyanate allow quantitative measurement in studies of toxicity. Pettigrew AR, Fell GS. Simplified colorimetric determination of thiocyanate in biological fluids, and its application to investigation of the toxic amblyopias. *Clin Chem* 1972;18:996–1000.

The average salary for an AACC member is \$19 387 (range, \$6500–\$70 000. *Clin Chem* 1972;18:480–2).

If all decisions could be this easy? Grannis GF, et al. Reports of the papers committee, 24th national meeting AACC. *Clin Chem* 1972;18:725–32.

The Journal switches to computerized photocomposition. BIOSIS, the originator of *Biological Abstracts*, performs the indexing for the first (and, mercifully, last) time.

Richard Nixon visits the People's Republic of China and meets with Mao Zedong.  
Lexitron introduces the first word-processing system.  
SMAC—the first computerized clinical analyzer—appears.  
Restriction endonuclease is used to cut DNA.

**1973** *Just the fats.* New techniques bring about many improvements in the area of lipid analyses this year. The discovery, characterization, and application of enzymes allow more facile analyses. Bucolo G, David H. Quantitative determination of serum triglycerides by the use of enzymes. *Clin Chem* 1973;19:476–82. Foster LB, Dunn RT. Stable reagents for determination of serum triglycerides by a colorimetric Hantzsch condensation method. *Clin Chem* 1973;19:338–40. Neri BP, Frings CS. Improved method for determination of triglycerides in serum. *Clin Chem* 1973;19:1201–2. Gottfried SP, Rosenberg B. Improved manual spectrophotometric procedure for determination of serum triglycerides. *Clin Chem* 1973;19:1077–8. Richmond W. Preparation and properties of a cholesterol oxidase from *Nocardia* sp. and its application to the enzymatic assay of total cholesterol in serum. *Clin Chem* 1973;19:1350–6. Seidel D, et al. Improved techniques for assessment of plasma lipoprotein patterns. I. Precipitation in gels after electrophoresis with polyanionic compounds. *Clin Chem* 1973;19:737–9.

*Bones and beyond.* A reference method and an assay for ionized calcium are described. Cali JP, et al. A referee method for the determination of total calcium in serum. *Clin Chem* 1973;19:1208–13. Ladenson JH, Bowers GN Jr. Free calcium in serum. I. Determination with the ion-specific electrode, and factors affecting the results. *Clin Chem* 1973;19:565–74.

*Immunoassay hits it big.* In just a decade since the first descriptions of RIA, radiometric and nonisotopic immunoassays start to be widely used in clinical laboratories. A list of commercial reagents fills 3 pages. Skelley DS, et al. RIA. *Clin Chem* 1973;19:146–86 (also see J.S. King's Editorial on p. 145). Zettner A. Principles of competitive binding assays (saturation analysis). 1. Equilibrium techniques. *Clin Chem* 1973;19:699–705. Dunn RT, Foster LB. Radioassay of serum folate. *Clin Chem* 1973;19:1101–5. Schneider RS, et al. Homogeneous enzyme immunoassay for opiates in urine. *Clin Chem* 1973;19:821–5.

*The birth of flow cytometry.* Leonard Herzenberg and colleagues describe the fluorescence-activated cell sorter. Hulett HR, et al. Development and application of a rapid cell sorter. *Clin Chem* 1973;19:813–6.

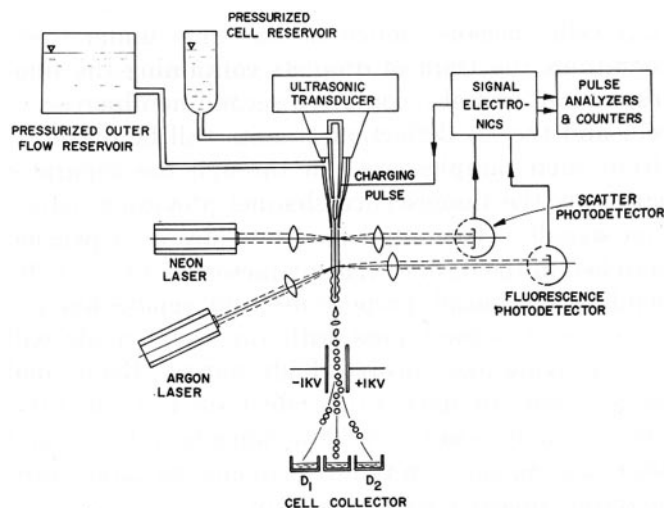

*Polyamines.* Marton LJ, et al. Measurement of putrescine, spermidine, and spermine in physiological fluids by use of an amino acid analyzer. *Clin Chem* 1973;19:923–6.

*Maybe one day they'll think electronic publishing is quaint.* The Journal is in the forefront in state-of-the-art media for dissemination as a microfiche version is published along with the print copy. (*Clin Chem* 1973;19:1236–8).

*Hard to believe that they didn't before.* The FDA is given regulatory responsibility for in vitro diagnostic products (*Clin Chem* 1973;19:1425–6).

Federal Express begins operations; it delivers 186 packages to 25 US cities on its inaugural night. Arab oil-producing nations embargo shipments to the US, Europe, and Japan, precipitating an energy crisis in the industrialized world. The Sydney Opera House is opened by Queen Elizabeth II.

**1974** *“-ase” in the hole.* A practical, completely enzymatic procedure for cholesterol is published. It uses cholesterol esterase, cholesterol oxidase, and peroxidase. Until this time, only chemical methods were used, which required dehydrating and oxidation to form a sulfonic acid. These reactions required decidedly instrument-unfriendly strong-acid media. Allain CC, et al. Enzymatic determination of total serum cholesterol. *Clin Chem* 1974;20:470–5.

*One from column A.* Frustrated that analysis by electrophoresis and subsequent staining was not sufficiently quantitative for the measurement of CK isoenzymes, Mercer develops a minicolumn technique useful for a clinical laboratory setting. Mercer DW. Separation of tissue and serum creatine kinase isoenzymes by ion-exchange column chromatography. *Clin Chem* 1974;20:36–40.

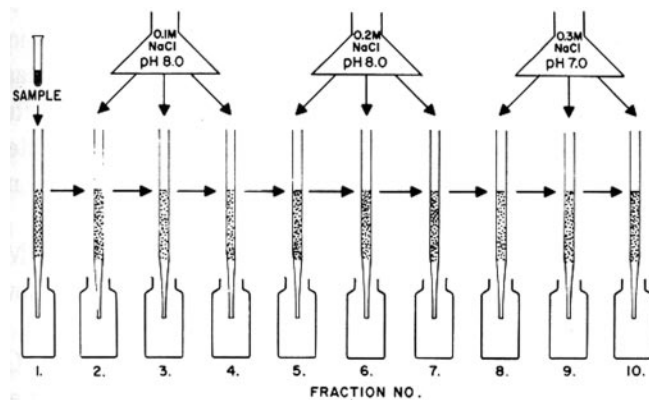

*Computer programs for RIA and IRMA: curve-fitting, data analysis, and more.* Rodbard D. Statistical quality control and routine data processing for RIAs and immunoradiometric assays *Clin Chem* 1974;20:1255–70.

*Hemoglobins easily separated.* Schneider RG. Differentiation of electrophoretically similar hemoglobins—such as S, D, G, and P; or A<sub>2</sub>, C, E, and O—by electrophoresis of the globin chains. *Clin Chem* 1974;20:1111–5.

*Cortisol RIAs.* New radiometric assays for serum cortisol are published. Foster LB, Dunn RT. Single-antibody technique for RIA of cortisol in unextracted serum or plasma. *Clin Chem* 1974;20:365–8. Farmer RW, Pierce CE. Plasma cortisol determination: RIA and competitive protein binding compared. *Clin Chem* 1974;20:411–4.

*It is rocket science from Dr. Laurell.* Proteins are quantitatively measured in CSF. Ganrot K, Laurell CB. Measurement of IgG and albumin content of cerebrospinal fluid, and its interpretation. *Clin Chem* 1974;20:571–3.

*PEG-enhanced nephelometry.* Lizana J, Hellsing K. Polymer enhancement of automated immunological nephelometric analysis, as illustrated by determination of urinary albumin. *Clin Chem* 1974;20:415–20.

Serum folic acid is suggested to be associated with serum proteins. The analytical implications are discussed. Zettner A, Duly PE. New evidence for a binding principle specific for folates as a normal constituent of human serum. *Clin Chem* 1974;20:1313–9.

*Clinical Chemistry* has 8343 subscribers (*Clin Chem* 1974;20:106–7). A special issue (February) is devoted entirely to toxicology (*Clin Chem* 1974;20:111–311).

The FDA clarifies its role in regulation of diagnostic kits (*Clin Chem* 1974;20:924–8).

US President Richard Nixon announces his resignation.  
Charles de Gaulle Airport opens in Paris.  
PostIt Notes are developed.

**1975** *DNA in serum.* A technique is described for using radiolabeled RNA as a probe for the identification of DNA through formation of RNA-DNA hybrids. Steinman CR. Use of nucleic acid hybridization for specific detection of submicrogram quantities of DNA, and its application to human plasma. *Clin Chem* 1975;21:407–11.

The trace elements special issue (*Clin Chem* 1975;21:467–634) includes the following papers: Prasad AS, et al. Zinc deficiency in sickle cell disease. *Clin Chem* 1975;21:582–7. Burch RE, et al. Newer aspects of the roles of zinc, manganese, and copper in human nutrition. *Clin Chem* 1975;21:501–20. Fernandez FJ. Micro-method for lead determination in whole blood by

atomic absorption, with use of the graphite furnace. *Clin Chem* 1975;21:558–61.

**Theophylline by GC.** Johnson GF, et al. Gas-chromatographic determination of theophylline in human serum and saliva. *Clin Chem* 1975; 21:144–7. Weinberger M, Chidsey C. Rapid analysis for theophylline in serum by use of high-pressure cation-exchange chromatography. *Clin Chem* 1975;21:834–7.

**Nucleotide extraction.** Khym JX. An analytical system for rapid separation of tissue nucleotides at low pressures on conventional anion exchangers. *Clin Chem* 1975;21:1245–52.

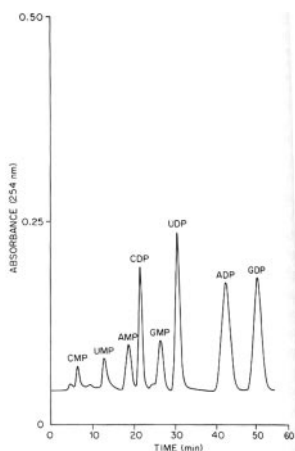

CK isoenzymes are the “Molecules of the Year”, and many papers on measurement and clinical utility appear. Mercer DW, Varat MA. Detection of cardiac-specific creatine kinase isoenzyme in sera with normal or slightly increased total creatine kinase activity. *Clin Chem* 1975;21:1088–92. Henry PD, et al. Rapid separation of plasma creatine kinase isoenzymes by batch adsorption on glass beads. *Clin Chem* 1975;21:844–9. Yasmineh WG, Hanson NQ. Electrophoresis on cellulose acetate and chromatography on DEAE-Sephadex A-50 compared in the estimation of creatine kinase isoenzymes. *Clin Chem* 1975;21:381–6.

**Protein standardization.** Paving the way is Dumas BT. Standards for total serum protein assays—a collaborative study. *Clin Chem* 1975;21:1159–66.

**Effects of drugs V2.0.** This special issue “involved an entirely new concept in publication—the printing of an article directly from a computer tape delivered by the authors.” Young DS, et al. Effects of drugs on clinical laboratory tests. *Clin Chem* 1972;18:1041–303.

**Delta check. The patient as control.** The procedure is based on computer detection of changes in each individual patient’s test results. Ladenson JH. Patients as their own controls: use of the computer to identify “laboratory error”. *Clin Chem* 1975;21:1648–53.

*Clinical Chemistry* publishes over 2000 printed pages in one year for the first time.

The Vietnam War ends as North Vietnamese forces take over Saigon and South Vietnam surrenders unconditionally.

The Khmer Rouge proclaim the “Democratic Republic of Kampuchea” in Cambodia, and Pol Pot becomes its Prime Minister.

Paul Allen (age 22) and Bill Gates (age 19) found Micro-soft; the hyphen disappears in 1979.

**1976** *CK again.* Szasz and colleagues publish the first of their papers on CK, which established the foundation for today’s measurement and standardization. Szasz G, et al. Creatine kinase in serum: 1. Determination of optimum reaction conditions. *Clin Chem* 1976;22:650–6.

**V is for vitamin.** Apofoms of vitamin B-dependent enzymes in erythrocytes are used in the determination of vitamin B status in individuals. A chromatographic method is devised for the determination of 25-hydroxyvitamin D<sub>3</sub>. Bayoumi RA, Rosalki SB. Evaluation of methods of coenzyme activation of erythrocyte enzymes for detection of deficiency of vitamin B<sub>1</sub>, B<sub>2</sub>, and B<sub>6</sub>. *Clin Chem* 1976;22:327–35. Bouillon R, et al. Measurement of 25-hydroxyvitamin D<sub>3</sub> in serum. *Clin Chem* 1976;22:364–8.

**IgG, IgM, IgA by light scattering in a laser nephelometer.** Deaton CD, et al. Use of laser nephelometry in the measurement of serum proteins. *Clin Chem* 1976;22: 1465–71.

**Renin.** Fyhrquist F, et al. RIA of plasma renin activity. *Clin Chem* 1976;22:250–6.

**More lipids.** HDL-cholesterol is quantified by precipitation, apo-A by rocket electrophoresis. Steele BW, et al. Enzymatic determinations of cholesterol in high-den-

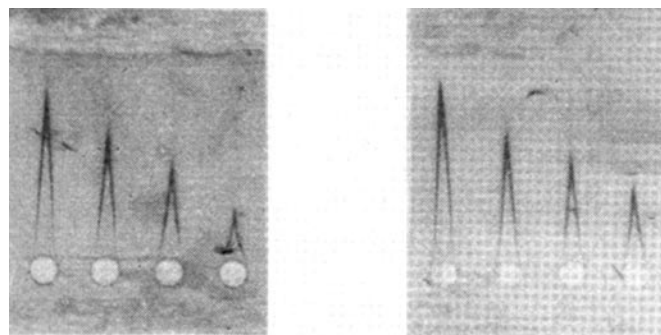

A

B

sity-lipoprotein fractions prepared by a precipitation technique. *Clin Chem* 1976;22:98–101. Kostner GM. Enzymatic determination of cholesterol in high-density lipoprotein fractions prepared by polyanion precipitation. *Clin Chem* 1976;22:695. Curry MD, et al. Determination of apolipoprotein A and its constitutive A-I and A-II polypeptides by separate electroimmunoassays. *Clin Chem* 1976;22:315–22.

*The CLIA we never saw.* CLIA'76 is passed by the US Senate, but not the House, after media reports of shoddy laboratory results and unethical payments (*Clin Chem* 1976;22:410;1417). Many features of CLIA'76 reappeared 12 years later as CLIA'88.

*Clinical Chemistry's* Special Issue is Toxicology (*Clin Chem* 1976;22:711–913).

Apple Computer is founded.  
Mysterious disease strikes American Legion convention in Philadelphia.  
Jimmy Carter is elected US president.  
A chemical plant accident in Seveso, Italy, releases large amounts of dioxins.

## RIA CPB TLC GLC-MS

Suffering from acronymophobia?  
It's painful, but seldom fatal.  
Alleviated by a little in-depth information, packaged in a red, readily absorbable capsule, to be taken each month, p.r.n., ad lib., or ut dict.

**R<sub>x</sub>:**  
**Clinical Chemistry**

— \$25/yr (in U.S.)

Then all you have to worry about is ochlophobia (the journal is very popular).

A Journal ad from 1976 (*ClinChem* 1976;22:714).

**1977** *Proteins by rate.* By measuring the rate of polymer-enhanced immunochemical precipitation, proteins are measured in a minute. Sternberg JC. A rate nephelometer for measuring specific proteins by immunoprecipitation reactions. *Clin Chem* 1977;23:1456–64.

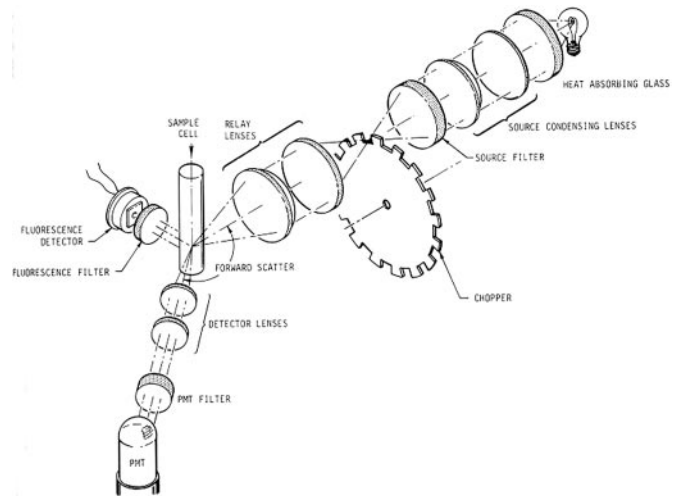

*Lipids: further developments.* Lopes-Virella MF, et al. Cholesterol determination in high-density lipoproteins separated by three different methods. *Clin Chem* 1977; 23:882–4. Bronzert TJ, Brewer HB Jr. New micro-method for measuring cholesterol in plasma lipoprotein fractions. *Clin Chem* 1977;23:2089–98.

*Starch and wheat.* A method specific for pancreatic amylase uses an inhibitor of salivary amylase from wheat. O'Donnell MD, et al. Differential serum amylase determination by use of an inhibitor, and design of a routine procedure. *Clin Chem* 1977;23:560–6.

*Insulin RRA.* Gambhir KK, et al. Insulin radioreceptor assay for human erythrocytes. *Clin Chem* 1977;23:1590–5.

*Drugs.* Saliva as a matrix, HPLC, and a new homogeneous fluorescent immunoassay. Horning MG, et al. Use of saliva in therapeutic drug monitoring. *Clin Chem* 1977;23:157–64. Kabra PM, et al. Simultaneous measurement of phenobarbital, phenytoin, primidone, ethosuximide, and carbamazepine in serum by high-pressure liquid chromatography. *Clin Chem* 1977;23: 1284–8. Burd JF, et al. Homogeneous reactant-labeled fluorescent immunoassay for therapeutic drugs exemplified by gentamicin determination in human serum. *Clin Chem* 1977;23:1402–8.

**HPLC for nucleosides, metanephrine, and drugs.** Davis GE, et al. High-performance liquid chromatographic separation and quantitation of nucleosides in urine and some other biological fluids. *Clin Chem* 1977;23:1427–35. Shoup RE, Kissinger PT. Determination of urinary normetanephrine, metanephrine, and 3-methoxytyramine by liquid chromatography, with amperometric detection. *Clin Chem* 1977;23:1268–74. Kabra PM, et al. Simultaneous measurement of phenobarbital, phenytoin, primidone, ethosuximide, and carbamazepine in serum by high-pressure liquid chromatography. *Clin Chem* 1977;23:1284–8.

**Look Ma. No catalytic activity.** Immunoassay of a protein is used as a cardiac marker. Rosano TG, Kenny MA. A RIA for human serum myoglobin: method development and normal values. *Clin Chem* 1977;23:69–75.

The AACC Beckman Conference is inaugurated (*Clin Chem* 1977;23:621;1197).

**More on kit procedures.** Schoen I, Rice EG. [Letter and Reply] How broad is (should be) the kit producer's responsibility for supplying "normal" values? *Clin Chem* 1977;23:1373–4.

The Journal's circulation is now 10 440.

**Clinical chemistry as an "industry".** Dr. King muses:

For better or worse, like it or not, the "compassionate science" is becoming more and more indistinguishable from General Motors in its approach to the "customers," primarily of course as a result of quantum leaps in automation technology.

The two major current trends foreseen for clinical chemistry in the United States are (a) a greater demand for "stat" instruments and (b) a demand for high-volume profiling machines.

As an example of the latter, Metpath, a commercial laboratory whose revenues reportedly increased by 45% (to \$16.15 million) from 1976 to 1977, found it necessary to purchase four AutoChemist analyzers, and has ordered five more (\$500 000 each, 5000 samples/day capacity each). This example, not typical, illustrates that clinical chemistry increasingly is filing the popular image of Big Business, complete with mergers, acquisitions, diversifications and all its other accoutrements. The major commercial laboratories are growing at what one official called an "absurd" rate, with pretax earnings approaching 12% and steadily rising: not surprisingly, this gives the proprietors reason to expect even closer scrutiny by the federal government (*Clin Chem* 1977;23:1956–7).

The world's last known case of smallpox appears in Somalia.

The number of hosts on ARPANET exceeds 100.  
British Airways inaugurates regular supersonic service on the *Concorde*.

**1978** *Now on film!* An automated, dry-chemistry system is described and applied to several clinically useful analytes in serum. Curme HG, et al. Multilayer film elements for clinical analysis: general concepts. *Clin Chem* 1978;24:1335–42. Spayd RW, et al. Multilayer film elements for clinical analysis: applications to representative chemical determinations. *Clin Chem* 1978;24:1343–50.

**Kinetic energy.** Basic kinetic properties of enzymes are used to predict optimal assay concentrations and a basis for standardization. Bergmeyer HU, et al. Optimization of methods for aspartate aminotransferase and alanine aminotransferase. *Clin Chem* 1978;24:58–73.

**HDL-cholesterol.** Further developments are made in the separation and measurement of HDL-cholesterol. Finley PR, et al. Cholesterol in high-density lipoprotein: use of  $Mg^{2+}$ /dextran sulfate in its enzymic measurement. *Clin Chem* 1978;24:931–3. Warnick GR, Albers JJ. Heparin- $Mn^{2+}$  quantitation of high-density-lipoprotein cholesterol: an ultrafiltration procedure for lipemic samples. *Clin Chem* 1978;24:900–4. Albers JJ, et al. Multilaboratory comparison of three heparin- $Mn^{2+}$  precipitation procedures for estimating cholesterol in high-density lipoprotein. *Clin Chem* 1978;24:853–6.

**HPLC further applied to assay of vitamin, drugs, and catecholamines.** DeRuyter MG, De Leenheer AP. Simultaneous determination of retinol and retinyl esters in serum or plasma by reversed-phase high-performance liquid chromatography. *Clin Chem* 1978;24:1920–3. Jones G. Assay of vitamin  $D_2$  and  $D_3$ , and 25-hydroxyvitamin  $D_2$  and  $D_3$  in human plasma by high-performance liquid chromatography. *Clin Chem* 1978;24:287–98. Proelss HF, et al. High-performance liquid-chromatographic simultaneous determination of commonly used tricyclic antidepressants. *Clin Chem* 1978;24:1948–53. Anhalt JP, Brown SD. High-performance liquid-chromatographic assay of aminoglycoside antibiotics in serum. *Clin Chem* 1978;24:1940–7. Davis TP, et al. High-performance liquid-chromatographic separation and fluorescence measurement of

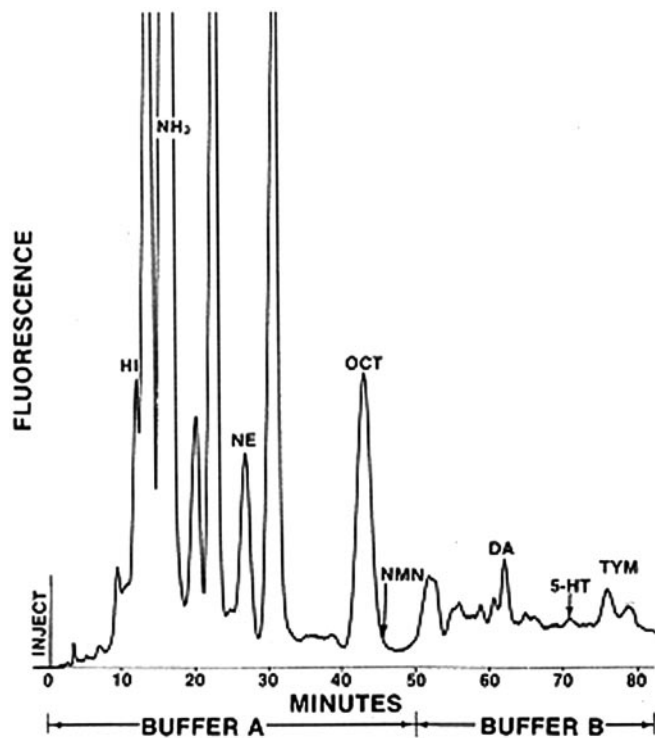

biogenic amines in plasma, urine, and tissue. *Clin Chem* 1978;24:1317-24.

Louise Brown, the first "test-tube baby," is born. Karol Cardinal Wojtyła of Poland is elected as Pope John Paul II.

**1979** *Creatine kinase: its not just for MI anymore.* The clinical relevance of CK-B subunit is explored. Silverman LM, et al. Creatine kinase BB: a new tumor-associated marker. *Clin Chem* 1979; 25:1432-5. Urdal P, Landaas S. Macro creatine kinase BB in serum, and some data on its prevalence. *Clin Chem* 1979;25:461-5.



*The clinical chemist's favorite relationship exposed.* Cornbleet PJ, Gochman N. Incorrect least-squares regression coefficients in method-comparison analysis. *Clin Chem* 1979;25:432-8.

*Lipids and lipoproteins: further developments in classification and assay.* Warnick GR, et al. Gel isoelectric focusing method for specific diagnosis of familial hyperlipoproteinemia type 3. *Clin Chem* 1979;25:279-84. Warnick GR, et al. Comparison of current methods for high-density lipoprotein cholesterol quantitation. *Clin Chem* 1979;25:596-604. Grove TH. Effect of reagent pH on determination of high-density lipoprotein cholesterol by precipitation with sodium phosphotungstate-magnesium. *Clin Chem* 1979;25:560-4. Megraw RE, et al. Manual and continuous-flow colorimetry of triacylglycerols by a fully enzymic method. *Clin Chem* 1979; 25:273-8.

*More HPLC.* Frey FJ, et al. Liquid-chromatographic measurement of endogenous and exogenous glucocorticoids in plasma. *Clin Chem* 1979;25:1944-7. Moyer TP, et al. Analysis for urinary catecholamines by liquid chromatography with amperometric detection: methodology and clinical interpretation of results *Clin Chem* 1979;25:256-63.

*Antiglobalization circa 1979.* This Journal's love/hate relationship with the Système Internationale d'Unités is out in the open. An editorial bemoans the imposition of "SI units". Doumas BT. IFCC documents and interpretation of SI units—a solution looking for a problem *Clin Chem* 1979;25:655-8. A flurry of responses ensues; some are publishable. Lines JG. SI units: another view. *Clin Chem* 1979;25:1331-3 (also see 1980). Other IFCC recommendations include renaming some common analytes: "carbamide" is preferred to "urea", "creatininium" to "creatinine", and "adrenalinium" to "epinephrine". Editor King doubts that US clinical chemists will soon adopt these recommendations (*Clin Chem* 1979;25:1989). Google reality-check in 2004: creatininium, ~60 webpages; creatinine, ~370 000 webpages.

*Clinical Chemistry* marks its 25th year of publication (*Clin Chem* 1979;25:2063-4).

Shiite Muslim leader Ayatollah Khomeini returns to Iran.

Sony introduces the Walkman radio.

The first commercial network of cellular telephones is established (Tokyo, Japan).

The first spreadsheet program, VisiCalc, is released.





*Clinical Chemistry* publishes a nearly 500-page supplement summarizing the effects of disease on clinical laboratory test results. Listing is provided both by the laboratory procedure and the disease. Friedman RB. Effects of diseases on clinical laboratory tests. *Clin Chem* 1980;26:1D–476D.

Journal circulation stands at 12 779.

Mount St. Helens erupts in Washington state.  
Republican Ronald Reagan defeats incumbent Democrat Jimmy Carter in the US presidential election.  
War begins between Iran and Iraq.  
The Soviet Union invades Afghanistan.

**1981** *Cyclosporin*. A liquid-chromatographic assay for cyclosporin, without derivatization, can quantify the drug at concentrations observed clinically and takes only 10 min of analysis time. Sawchuk RJ, Cartier LL. Liquid-chromatographic determination of cyclosporin A in blood and plasma. *Clin Chem* 1981;27:1368–71.

*Proteomics circa 1981*. A system for the analysis of high-resolution two-dimensional gel-electrophoresis patterns is published; it includes programs for image acquisition, background subtraction and smoothing, spot detection, gaussian spot modeling, and pattern matching and comparison. It allows quantitative mea-

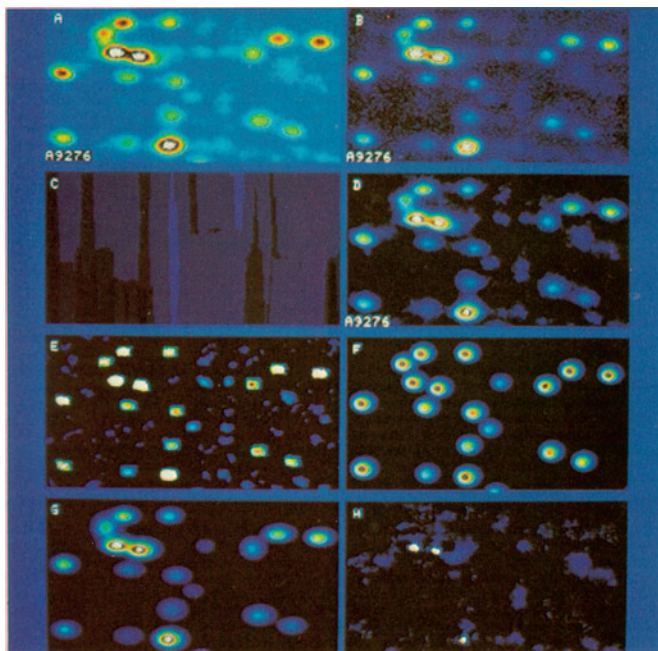

surement of hundreds of proteins in biological samples. Anderson NL, et al. The TYCHO system for computer analysis of two-dimensional gel electrophoresis patterns. *Clin Chem* 1981;27:1807–20.

*Rank and bile*. A simple and direct serum assay for bile acids is described and is shown to be useful as a liver-function test. Mashige F, et al. Direct spectrophotometry of total bile acids in serum *Clin Chem* 1981;27:1352–6.

*CE for amino acids, peptides, and urinary amines*. Jorgenson JW, Lukacs KD. Free-zone electrophoresis in glass capillaries. *Clin Chem* 1981;27:1551–3.

*FPIA*. A fully automated fluorescence polarization immunoassay system is described and applied to therapeutic substances. Jolley ME, et al. Fluorescence polarization immunoassay. I. Monitoring aminoglycoside antibiotics in serum and plasma. *Clin Chem* 1981;27:1190–7; II. Analyzer for rapid, precise measurement of fluorescence polarization with use of disposable cuvettes. *Clin Chem* 1981;27:1198–201; III. An automated system for therapeutic drug determination. *Clin Chem* 1981;27:1575–9.

Antisera raised against the C-terminal fragment of glucagon are used to develop a RIA of pancreatic glucagons. Nishino T. Glucagon RIA with use of antiserum to glucagon C-terminal fragment. *Clin Chem* 1981;27:1690–7.

*Clinical Chemistry's* circulation stands at 13 596.

The AIDS disease is recognized.  
Both Pope John Paul II and US President Ronald Reagan are wounded in assassination attempts.  
Prince Charles of England marries Lady Diana Spencer. Millions worldwide watch on television.  
The IBM PC is introduced.

**1982** *IGF-1 and vWF*. Baxter RC, et al. RIA for somatomedin C: comparison with radioreceptor assay in patients with growth-hormone disorders, hypothyroidism, and renal failure. *Clin Chem* 1982;28:488–95. Cejka J. Enzyme immunoassay for factor VIII-related antigen. *Clin Chem* 1982;28:1356–8.

*AA by LC*. Amino acids are measured by derivatization and HPLC in <1 h. The limit of detection is estimated

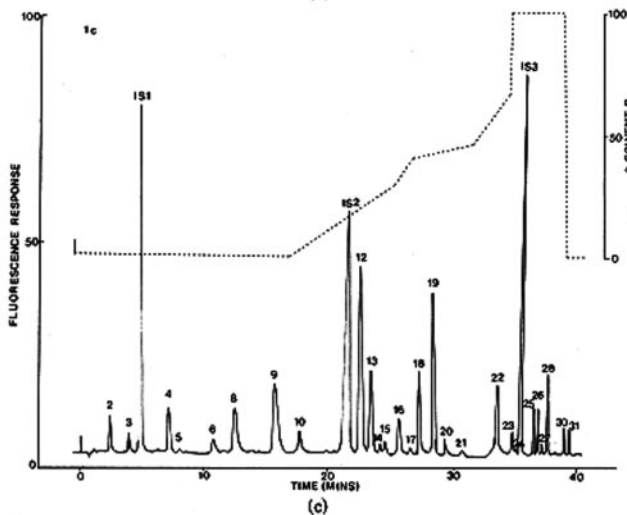
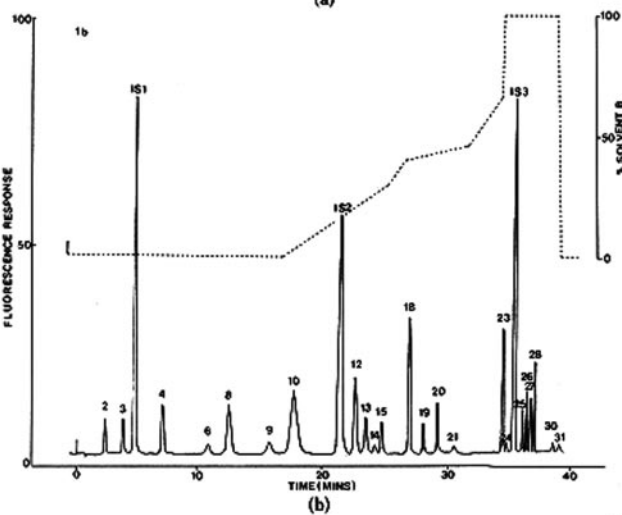
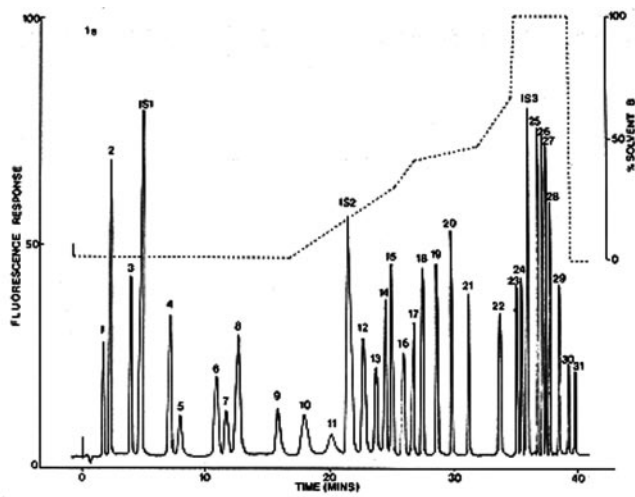

as 38 fmol. Turnell DC, Cooper JD. Rapid assay for amino acids in serum or urine by pre-column derivatization and reversed-phase liquid chromatography. *Clin Chem* 1982;28:527-31.

*Move over Playboy.* A special issue (number 4) has the Journal's first fold-out. Anderson NG, Anderson L. The human protein index. *Clin Chem* 1982;28:739-48. Tracy RP, et al. Two-dimensional gel electrophoresis of serum specimens from a normal population. *Clin Chem* 1982;28:890-9. Bravo R, Celis JE. Up-dated catalogue of HeLa cell proteins: percentages and characteristics of the major cell polypeptides labeled with a mixture of 16  $^{14}\text{C}$ -labeled amino acids. *Clin Chem* 1982;28:766-81.

*Good and bad apolipoproteins.* Fruchart JC, et al. Simultaneous measurement of plasma apolipoproteins A-I and B by electroimmunoassay. *Clin Chem* 1982;28:59-62.

*Quite likely.* A method to calculate likelihood ratios with any number of tests is published. Albert A. On the use and computation of likelihood ratios in clinical chemistry. *Clin Chem* 1982;28:1113-9.

*Delta bilirubin discovered.* It is "very tightly, if not covalently, bound to protein, most likely albumin". Lauff JJ, et al. Isolation and preliminary characterization of a fraction of bilirubin in serum that is firmly bound to protein. *Clin Chem* 1982;28:629-37.

From the editor's desk: "One of the greatest technological advances since sliced bread, in our view, is the word-processor, by which we mean a typewriter with a "memory," in which pages and pages of material can be stored and called forth. If the typist has a word processor, making corrections involves minutes as opposed to hours, and no brand-new errors introduced . . . [I]f you have access to such a wondrous machine, by all means lose no opportunity to utilize it. All of our lives will be happier" (*Clin Chem* 1982;28:2005).

*When was the last time you've seen these words?* IFCC neologisms promulgated: entic, areic, massic, baric, and ergatic (*Clin Chem* 1982;28:1438).

*Clinical Chemistry's* circulation is 13 682. Harold Appleton, the first Editor of the Journal, dies.

Argentina invades the Falkland Islands, and Britain steps in to protect its territory  
TCP/IP communication is defined.  
The first computer virus, *Elk Cloner*, is written by 9th grader Rich Skrenta.

**1983** *I see the light.* Pulsed-light, time-resolved fluorometry of lanthanide chelates and chemiluminescent acridinium esters are used as sensitive signals in nonisotopic immunoassays. Soini E, Kojola H. Time-resolved fluorometer for lanthanide chelates—a new generation of nonisotopic immunoassays. *Clin Chem* 1983;29:65–8. Weeks I, et al. Acridinium esters as high-specific-activity labels in immunoassay. *Clin Chem* 1983;29:1474–9.

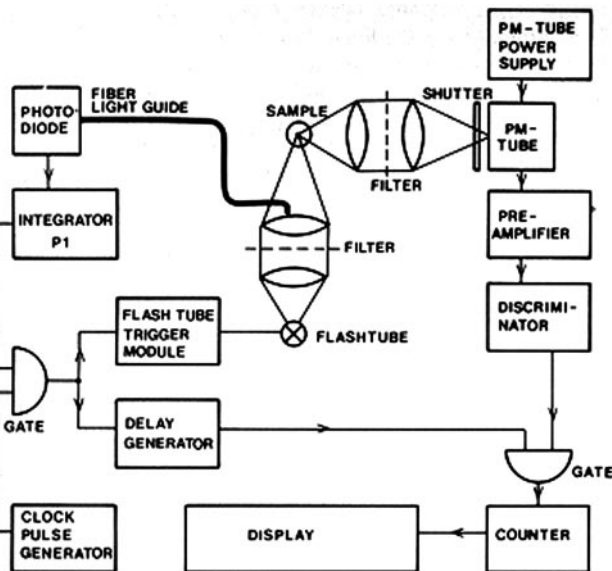

*Another spin on the immunoassay ball.* The latex immunoassay, a nonisotopic method based on agglutination by protein of calibrated latex particles coated with a specific antibody, is described. Bernard AM, Lauwers RR. Continuous-flow system for automation of latex immunoassay by particle counting. *Clin Chem* 1983;29:1007–11.

**CA 19-9.** A carbohydrate antigenic determinant that is increased in sera from patients with adenocarcinomas is discovered and measured by a radioimmunometric sandwich assay. Del Villano BC, et al. Radioimmunometric assay for a monoclonal antibody-defined tumor marker, CA 19-9. *Clin Chem* 1983;29:549–52.

*Lipids: assays are ever easier and faster.* McGowan MW, et al. A peroxidase-coupled method for the colorimetric determination of serum triglycerides. *Clin Chem* 1983;29:538–42. Siedel J, et al. Reagent for the enzymatic determination of serum total cholesterol with improved lipolytic efficiency. *Clin Chem* 1983;29:1075–80.

*LC and RIA continue.* Even with the dramatic increase in nonisotopic immunoassay platforms, LC and RIA con-

tinue to enjoy expanding roles in medical laboratories. Carruthers SG, et al. Simplified liquid-chromatographic analysis for cyclosporin A, and comparison with RIA. *Clin Chem* 1983;29:180–3. Catignani GL, Bieri JG. Simultaneous determination of retinol and  $\alpha$ -tocopherol in serum or plasma by liquid chromatography. *Clin Chem* 1983;29:708–12. Stockigt JR, et al. “Unbound analog” RIAs for free thyroxine measure the albumin-bound hormone fraction. *Clin Chem* 1983;29:1408–10. Lun S, et al. A direct RIA for aldosterone in plasma. *Clin Chem* 1983;29:268–71.

*Clinical Chemistry*, noting the explosive increase in immunoassay formats available to laboratorians, publishes a product guide for immunoassays (*Clin Chem* 1983;29:890–986).

Cellular phones make their first US appearance in Chicago.  
ARPANET officially changes to use of the Internet Protocol, creating the Internet.

**1984** *Another spin: NMR.* Low-molecular-weight species are identified by 400- and 500-MHz proton nuclear magnetic resonance of intact human urine. Bales JR, et al. Use of high-resolution proton nuclear magnetic resonance spectroscopy for rapid multicomponent analysis of urine. *Clin Chem* 1984;30:426–32. Bales JR, et al. Urinary excretion of acetaminophen and its metabolites as studied by proton NMR spectroscopy. *Clin Chem* 1984;30:1631–6.

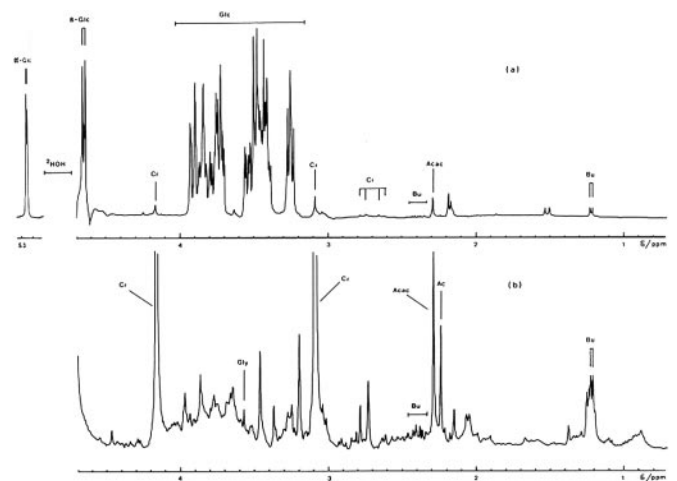

*Telling your liver from your elbow.* The use of wheat-germ lectin to separate and quantify bone and liver isoenzymes of alkaline phosphatase is described. Rosalki SB, Foo AY. Two new methods for separating and

quantifying bone and liver alkaline phosphatase isoenzymes in plasma. *Clin Chem* 1984;30:1182-6.

**O is for Optical.** Sutherland RM, et al. Optical detection of antibody-antigen reactions at a glass-liquid interface. *Clin Chem* 1984;30:1533-8.

**TSH and free  $T_3$  and  $T_4$ .** Cobb WE, et al. Use of a rapid, sensitive immunoradiometric assay for thyrotropin to distinguish normal from hyperthyroid subjects. *Clin Chem* 1984;30:1558-60. Liewendahl K, et al. Discrepancies between serum free triiodothyronine and free thyroxine as measured by equilibrium dialysis and analog RIA in nonthyroidal illnesses. *Clin Chem* 1984;30:760-2.

**New separation techniques.** Matson WR, et al. n-Electrode three-dimensional liquid chromatography with electrochemical detection for determination of neurotransmitters. *Clin Chem* 1984;30:1477-88. Sprecher DL, et al. Two-dimensional electrophoresis of human plasma apolipoproteins. *Clin Chem* 1984;30:2084-92.

**IEF of IgG OCB.** Olsson T, et al. Improved detection of oligoclonal IgG in cerebrospinal fluid by isoelectric focusing in agarose, double-antibody peroxidase labeling, and avidin-biotin amplification. *Clin Chem* 1984;30:1246-9.

**ACTH is measured without extraction.** Nicholson WE, et al. Rapid RIA for corticotropin in unextracted human plasma. *Clin Chem* 1984;30:259-65.

**Digoxin-lite.** Balzan S, et al. Digoxin-like immunoreactivity in normal human plasma and urine, as detected by a solid-phase RIA. *Clin Chem* 1984;30:450-1.

*Clinical Chemistry*, with more than 50% of its papers from outside the US for the first time, reflects on the "increasing international tone and authoritative voice of the journal" (*Clin Chem* 1984;30:1121).

The CD-ROM and audio CD are introduced by Philips and Sony.  
The Macintosh, with innovations of a mouse and a graphic interface, is introduced.  
Incumbent Ronald Reagan wins reelection to the US presidency.

**1985** **Hi HCy.** A practical method for homocysteine is introduced. Serum homocysteine is condensed with labeled adenosine in the presence of S-adenosylhomocysteine hydrolase. Refsum H, et al. Radioenzymic

determination of homocysteine in plasma and urine. *Clin Chem* 1985;31:624-8.

**Get the phenols out.** Because phenolic free radicals can cause anomalous results, a method is proposed that uses proteinase K and ethanol and obviates the use of phenol. Buffone GJ, Darlington GJ. Isolation of DNA from biological specimens without extraction with phenol. *Clin Chem* 1985;31:164-5.

**Put the phenols back in!** Certain phenol derivatives are found to enhance light emission from luminol by >1000-fold. The enhanced system enables a rapid, sensitive assay; it is applied to immunoassays for hCG, digoxin, and factor VIII-related antigen. Thorpe GH, et al. Phenols as enhancers of the chemiluminescent horseradish peroxidase-luminol-hydrogen peroxide reaction: application in luminescence-monitored enzyme immunoassays. *Clin Chem* 1985;31:1335-41.

**Foiled.** A sensitive method for measuring aluminum in biological samples is published. D'Haese PC, et al. Measurement of aluminum in serum, blood, urine, and tissues of chronic hemodialyzed patients by use of electrothermal atomic absorption spectrometry. *Clin Chem* 1985;31:24-9.

An extraction and HPLC method for measuring cyclosporine in blood is published and reveals a previously unknown cyclosporine metabolite may cause discrepancies between different methods for this analyte. Lensmeyer GL, Fields BL. Improved liquid-chromatographic determination of cyclosporine, with concomitant detection of a cell-bound metabolite. *Clin Chem* 1985;31:196-201.

*Clinical Chemistry* publishes guidelines that outline the requirements for hardware, software, and program design to be used in the immunoassay laboratory.

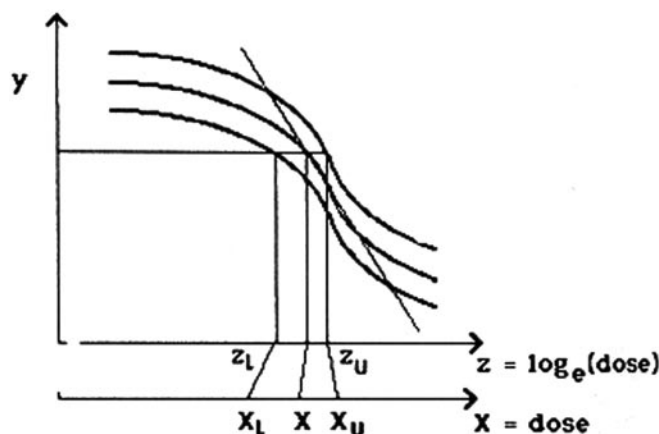

Dudley RA, et al. Guidelines for immunoassay data processing. *Clin Chem* 1985;31:1264–71.

Polyethylene glycol, dextran sulfate, and heparin-manganese are compared for their effectiveness in measuring HDL-cholesterol. Warnick GR, et al. Comparison of improved precipitation methods for quantification of high-density lipoprotein cholesterol. *Clin Chem* 1985;31:217–22.

NMR is used to detect, identify, and study the major normal and abnormal organic acid metabolites in urine from patients. The technique requires <1 mL, requires no extraction or derivatization, and takes <10 min. The authors “believe that it is particularly suitable for the rapid and acute diagnosis of inborn errors of metabolism, especially the organic acidurias, and for acute pediatric clinical care.” Iles RA, et al. Use of proton nuclear magnetic resonance spectroscopy in detection and study of organic acidurias. *Clin Chem* 1985;31:1795–801.

*Standardization of “fructosamine” and bilirubin.* Baker JR, et al. Use of protein-based standards in automated colorimetric determinations of fructosamine in serum. *Clin Chem* 1985;31:1550–4. Dumas BT, et al. Candidate reference method for determination of total bilirubin in serum: development and validation. *Clin Chem* 1985;31:1779–89.

Mikhail Gorbachev becomes Soviet Premier: begins era of “Glasnost”.  
 New Coke is released.  
 Wreckage from the Titanic is discovered.  
 Michael Brown and Joseph Goldstein are awarded the Nobel Prize for describing the regulation of cholesterol metabolism.  
 Microsoft Windows version 1.0 is released, nearly 2 years later than when it had been promised.

**1986** *Apo-alphabet.* Immunoturbidimetric assays are developed and reference intervals established for apolipoproteins (Rifai N, King ME. Immunoturbidimetric assays of apolipoproteins A, AI, AII, and B in serum. *Clin Chem* 1986;32:957–61). The apolipoprotein E polymorphism is shown to affect total and LDL-cholesterol concentrations in serum affecting risk of coronary heart disease and myocardial infarction (Len-

zen HJ, et al. Association of apolipoprotein E polymorphism, low-density lipoprotein cholesterol, and coronary artery disease. *Clin Chem* 1986;32:778–81).

*Even further expansion of HPLC.* Eisenhofer G, et al. Simultaneous liquid-chromatographic determination of 3,4-dihydroxyphenylglycol, catecholamines, and 3,4-dihydroxyphenylalanine in plasma, and their responses to inhibition of monoamine oxidase. *Clin Chem* 1986;32:2030–3. Hollis BW. Assay of circulating 1,25-dihydroxyvitamin D involving a novel single-cartridge extraction and purification procedure. *Clin Chem* 1986;32:2060–3. Jeppsson JO, et al. Measurement of hemoglobin A<sub>1c</sub> by a new liquid-chromatographic assay: methodology, clinical utility, and relation to glucose tolerance evaluated. *Clin Chem* 1986;32:1867–72. Milne DB, Botnen J. Retinol,  $\alpha$ -tocopherol, lycopene, and  $\alpha$ - and  $\beta$ -carotene simultaneously determined in plasma by isocratic liquid chromatography. *Clin Chem* 1986;32:874–6.

*Some Tums with that lemonade?* Ingestion of both aluminum hydroxide and citric acid led to a pronounced increase in serum aluminum concentrations, probably as a result of formation and absorption of aluminum-citrate complexes. Slanina P, et al. Dietary citric acid enhances absorption of aluminum in antacids. *Clin Chem* 1986;32:539–41.

*TPA.* Specific determination of tissue plasminogen activator, and its inhibitor, in plasma allows multiple samples to be assayed simultaneously within a few hours. A procedure for improving the specificity of ELISA methods also was devised. Chmielewska J, Wiman B. Determination of tissue plasminogen activator and its “fast” inhibitor in plasma. *Clin Chem* 1986;32:482–5. Ranby M, et al. Age dependence of tissue plasminogen activator concentrations in plasma, as studied by an improved enzyme-linked immunosorbent assay. *Clin Chem* 1986;32:2160–5.

*Heterophile antibody interference.* Circulating human antibodies reactive with animal proteins are demonstrated and shown to be a previously unsuspected source of interference in immunoassays. Boscato LM, Stuart MC. Incidence and specificity of interference in two-site immunoassays. *Clin Chem* 1986;32:1491–5.

*Clinical Chemistry* publishes the proceedings of the 9th Annual A.O. Beckman Conference for the first time; previously they were issued in book form (*Clin Chem* 1986;32:B1–106).

The January issue inaugurates the appearance of Technical Briefs as a new format to "summarize findings that are of interest to a relatively limited audience". Readers are directed to contact the authors for fuller details. Briefs originally were of abstract length, with no references (*Clin Chem* 1986;32:2234).

Following the Santa Fe conference in May, King editorializes on the "National Laboratory Human Gene Library Project" and other "Big Science" projects. King JS. Time to think big in human biology? *Clin Chem* 1986;32:1600-1.

One of the reactors at the Chernobyl nuclear plant explodes.  
The first laptop computer is introduced by IBM.  
There are now ~5000 hosts on ARPANET.

**1987** *Dem Bones*. Advances in the laboratory evaluation of disorders of calcium metabolism: an IRMA procedure for measurement of PTH is established (Nussbaum SR, et al. Highly sensitive two-site immunoradiometric assay of parathyrin, and its clinical utility in evaluating patients with hypercalcemia. *Clin Chem* 1987;33:1364-7). Tartrate-resistant acid phosphatase is suggested as a marker of bone metabolism and resorption (Lau KH, et al. Characterization and assay of tartrate-resistant acid phosphatase activity in serum: potential use to assess bone resorption. *Clin Chem* 1987;33:458-62).

*More on lipoproteins*. Although increased triglyceride concentrations had been observed in patients undergoing hemodialysis, *Clinical Chemistry* first reports that Lp(a) is also increased (Parra HJ, et al. Lp(a) lipoprotein in patients with chronic renal failure treated by hemodialysis. *Clin Chem* 1987;33:721). An enzyme immunoassay for ApoA-I is reported (Koren E, et al. Quantification of two different types of apolipoprotein A-I containing lipoprotein particles in plasma by enzyme-linked differential-antibody immunosorbent assay. *Clin Chem* 1987;33:38-43).

*TSH and free T<sub>4</sub> are evaluated as thyroid screening tests*. Spencer C, et al. Specificity of sensitive assays of thyrotropin (TSH) used to screen for thyroid disease in hospitalized patients. *Clin Chem* 1987;33:1391-6.

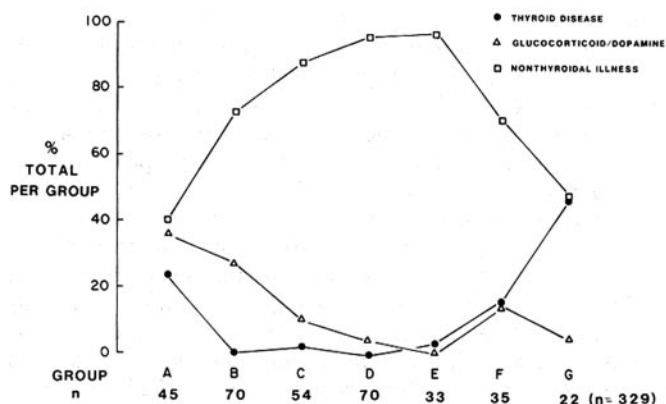

Methods for the accurate determination of neopterin, a product of activated macrophages, are published. Werner ER, et al. Simultaneous determination of neopterin and creatinine in serum with solid-phase extraction and on-line elution liquid chromatography. *Clin Chem* 1987;33:2028-33. Werner ER, et al. Determination of neopterin in serum and urine. *Clin Chem* 1987;33:62-6.

A double-antibody RIA for determination of tumor necrosis factor is reported. Teppo AM, Maury CP. RIA of tumor necrosis factor in serum. *Clin Chem* 1987;33:2024-7.

*Clinical Chemistry* publishes several special reports, including a consensus conference on cyclosporine (Critical issues in cyclosporine monitoring: report of the Task Force on Cyclosporine Monitoring. *Clin Chem* 1987;33:1269-88); an update on mapping the human genome from the Office of Technology Assessment (*Clin Chem* 1987;33:349-51), and a spirited debate on free thyroxine immunoassays (*Clin Chem* 1987;33:2137-52).

Oliver North, Jr., tells a congressional inquiry that higher officials approved his secret Iran-Contra operations.  
AZT wins FDA approval for use in the treatment of AIDS.  
Digging commences for the Channel Tunnel.

# 1988

*A rapid and precise assay is developed for a marker of fibrotic disease.*

Risteli J, et al. Rapid equilibrium RIA for the amino-terminal propeptide of human type III procollagen. *Clin Chem* 1988; 34:715–8.

**Tit for TAT.** Thrombin-antithrombin III complexes are measured in human plasma and may be useful for monitoring treatment in cases of disseminated intravascular coagulation. Hoek JA, et al. Laboratory and clinical evaluation of an assay of thrombin-antithrombin III complexes in plasma. *Clin Chem* 1988;34:2058–62.

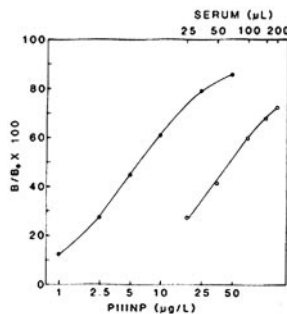

**Five-a-day.** A method is described for simultaneously determining several carotenoids. Thurnham DI, et al. Concurrent liquid-chromatographic assay of retinol,  $\alpha$ -tocopherol,  $\beta$ -carotene,  $\alpha$ -carotene, lycopene, and  $\beta$ -cryptoxanthin in plasma, with tocopherol acetate as internal standard. *Clin Chem* 1988;34:377–81.

**Fats of life.** *Clinical Chemistry* publishes a special report on the importance of the role of clinical laboratories and accurate and precise serum cholesterol measurements in reducing coronary heart disease (Current status of blood cholesterol measurement in clinical laboratories in the United States: a report from the Laboratory Standardization Panel of the National Cholesterol Education Program. *Clin Chem* 1988;34:193–201). However, Editor King challenges the usefulness of reducing dietary cholesterol intake (*Clin Chem* 1988; 34:1663).

**SOD.** A rapid and sensitive assay for the measurement of superoxide dismutase, a free radical scavenger, is published. Sun Y, et al. A simple method for clinical assay of superoxide dismutase. *Clin Chem* 1988;34:497–500.

A fax machine is installed in the *Clinical Chemistry* editorial office for the first time; a home-grown, computerized, manuscript tracking system is also installed (*Clin Chem* 1988;34:1663–4).

A Pan Am 747 explodes and crashes in Lockerbie, Scotland.  
The first Internet worm is unleashed.

# 1989

*DNA diagnostics.* Can clinical chemistry meet the challenge?

Robert Williamson's national lecture discusses the clinical chemistry of today—1989's tomorrow (Williamson R. Molecular genetics and the transformation of clinical chemistry. *Clin Chem* 1989;35: 2165–8). This year's Beckman conference is devoted to nucleic acid probes (*Clin Chem* 1989;35:B1–54). Numerous nucleic acid-based methods and papers appear: hybridization assay formats using acridinium-ester-labeled DNA probes are described and used to detect target sequences of bacterial organisms. Detection limits are over a million-fold lower than immunodiagnostic assays currently in use (Arnold LJ, et al. Assay formats involving acridinium-ester-labeled DNA probes. *Clin Chem* 1989;35:1588–94). Detection of Duchenne muscular dystrophy carriers by genetic analysis is illustrated by case studies (Prior TW, et al. Use of DNA probes in detecting carriers of Duchenne muscular dystrophy: selected case studies. *Clin Chem* 1989;35:679–83). The primary structures of the adrenergic receptors are described (Frielle T, et al. Properties of the  $\beta$ 1- and  $\beta$ 2-adrenergic receptor subtypes revealed by molecular cloning. *Clin Chem* 1989;35:721–5).

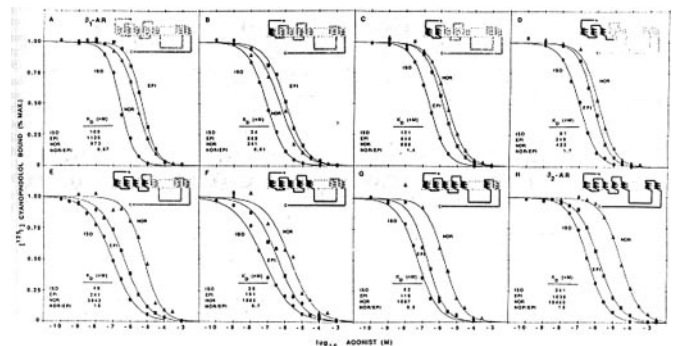

The first fully automated assay for plasma homocysteine allows the unattended analysis of 70 samples per day. Refsum H, et al. Fully automated fluorescence assay for determining total homocysteine in plasma. *Clin Chem* 1989;35:1921–7.

A new method for qualitative and quantitative determination of 61 biologically important compounds in urine, plasma, and amniotic fluid is published. Hoffmann G, et al. Quantitative analysis for organic acids in biological samples: batch isolation followed by gas chromatographic-mass spectrometric analysis. *Clin Chem* 1989;35:587–95.

**Cocaine and pregnancy.** Analysis of urine from neonates born to cocaine-using women shows that benzoylecgonine persists in urine for up to 5 days after delivery. Cocaine-exposed infants are shown to have neurobe-





panel. *Clin Chem* 1990;36:1841–6. Yatscoff RW, et al. Abbott TDx monoclonal antibody assay evaluated for measuring cyclosporine in whole blood. *Clin Chem* 1990;36:1969–73.

J. Stanton King retires as Executive Editor and David E. Bruns assumes the Editorship. Although King was not known for his indiscriminate endorsement of the latest technologies in publishing, he notes that “the days of the conventional printed scientific journal . . . may be numbered” (*Clin Chem* 1990;36:184;413–4).

Iraqi troops invade Kuwait, setting off the Persian Gulf War.  
The Hubble Space Telescope is launched.  
ARPANET ceases to exist; NSF allows commercial use of the Internet.

**1991** *Free or not too free.* PSA is shown to exist in serum largely as a complex that blocks epitopes for certain antibodies directed against the PSA molecule. Lilja H, et al. Prostate-specific antigen in serum occurs predominantly in complex with  $\alpha$ 1-antichymotrypsin. *Clin Chem* 1991;37:1618–25.

*T for 2.* Measurement of troponin T is claimed to be specific and sensitive method for the early and late diagnosis of acute myocardial infarction and “could provide a new criterion in laboratory diagnosis” of ML Gerhardt W. S-troponin T in suspected ischemic myocardial injury compared with mass and catalytic concentrations of S-creatine kinase isoenzyme MB. *Clin Chem* 1991;37:1405–11. Mair J, et al. Cardiac troponin T in diagnosis of acute myocardial infarction *Clin Chem* 1991;37:845–52.

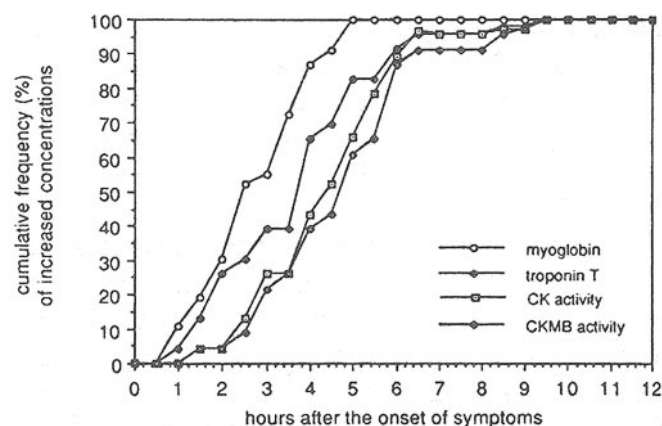

*ECL.* Electrochemiluminescence is used as a signal system for immunoassay. The new technology uses no

radioisotopes, has stable signaling compounds, has a large dynamic range, and has limits of detection that are in the femtomole per liter range. Blackburn GF, et al. Electrochemiluminescence detection for development of immunoassays and DNA probe assays for clinical diagnostics. *Clin Chem* 1991;37:1534–9.

*DNA enzyme immunoassay.* A method to specifically detect products of PCR is described. Mantero G, et al. DNA enzyme immunoassay: general method for detecting products of polymerase chain reaction. *Clin Chem* 1991;37:422–9.

*More on accuracy.* Laboratory data must constitute “timely and trustworthy information”. CLIA’88 is said to place a high priority on test accuracy. Bowers GN Jr. Clinical chemistry analyte reference systems based on true value. *Clin Chem* 1991;37:1665–6.

*Little (a): big problems.* Associations of lipoprotein(a) with clotting variables and blood pressure are uncovered. Heinrich J. Relationship of lipoprotein(a) to variables of coagulation and fibrinolysis in a healthy population *Clin Chem* 1991;37:1950–4.

*AFP.* Low concentrations of unconjugated estriol and  $\alpha$ -fetoprotein in maternal serum are found to be associated with Down syndrome-affected pregnancies. Spencer K. Evaluation of an assay of the free  $\beta$ -subunit of choriogonadotropin and its potential value in screening for Down’s syndrome. *Clin Chem* 1991;37:809–14.

The Journal has 14 000 subscribers and >32 000 readers in 90 countries; *Clinical Chemistry* is in the collections of 4500 libraries (*Clin Chem* 1991;37:137).

*DNA probe diagnostics: revolution or ripoff?* Summaries of papers presented at the San Diego Conference on Nucleic Acids appear in the Journal for the first time (*Clin Chem* 1991;37:599–618).

J Stanton King is named Editor Emeritus, continues his busy schedule (*Clin Chem* 1991; 7:137–8, 1662).

The USSR dissolves, Mikhail Gorbachev resigns, and Boris Yeltsin assumes power.  
The first Web page is posted. URL and HTTP standards are created by Tim-Berners Lee.  
The Mount Pinatubo volcano erupts; world weather patterns are affected.  
In the first Gulf War, Iraq is attacked by UN forces in January.

**1992** *T & I.* New assays for the measurement of troponins are reported. Bodor GS, et al. Development of monoclonal antibodies for an assay of cardiac troponin-I and preliminary results in suspected cases of myocardial infarction. *Clin Chem* 1992;38:2203–14. Katus HA, et al. Development and in vitro characterization of a new immunoassay of cardiac troponin T. *Clin Chem* 1992;38:386–93.

*Magnetic attractions.* Lipoproteins are shown to have NMR properties sufficiently distinct to permit quantification. Otvos JD, et al. Development of a proton nuclear magnetic resonance spectroscopic method for determining plasma lipoprotein concentrations and subspecies distributions from a single, rapid measurement. *Clin Chem* 1992;38:1632–8.

PTH-RP is suggested as the causative agent of hypercalcemia in most patients with cancer and measurements of it are suggested as useful in the diagnosis and management of patients with tumor-associated hypercalcemia. Pandian MR, et al. Modified immunoradiometric assay of parathyroid hormone-related protein: clinical application in the differential diagnosis of hypercalcemia. *Clin Chem* 1992;38:282–8.

*IR.* Near-infrared spectroscopy coupled with chemometric methods is applied to the noninvasive monitoring of blood/tissue glucose concentrations. Robinson MR, et al. Noninvasive glucose monitoring in diabetic patients: a preliminary evaluation. *Clin Chem* 1992;38:1618–22.

LDL oxidation is investigated as a link between plasma LDL and atherosclerotic lesions. Kleinveld HA, et al. Improved measurement of low-density-lipoprotein susceptibility to copper-induced oxidation: application of a short procedure for isolating low-density lipoprotein. *Clin Chem* 1992;38:2066–72.

*Going neural.* Multivariate analysis is used to differentiate benign from malignant breast conditions on the basis of the patterns of nine variables. Astion ML, Wilding P. Application of neural networks to the interpretation of laboratory data in cancer diagnosis. *Clin Chem* 1992;38:34–8.

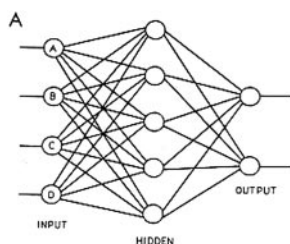

Associate Editors are added to the Editorial Board (*Clin Chem* 1992;38:325,1200). *Clinical Chemistry* publishes the proceedings of the first Clinical Chemistry Forum—Government Regulation: Can It Guarantee Quality in the Clinical Laboratory? *Clin Chem* 1992;38:1203–88.

The Cold War ends; Boris Yeltsin announces that Russia will stop targeting US cities with nuclear weapons.  
Bill Clinton defeats George H.W. Bush and H. Ross Perot in the US presidential election.  
The number of Internet hosts surpasses 1 million; the term "Surfing the Internet" is coined by Jean Armour Polly.

**1993** *A complex issue.* *Clinical Chemistry* publishes much more on PSA. Leinonen J, et al. Double-label time-resolved immunofluorometric assay of prostate-specific antigen and of its complex with alpha 1-antichymotrypsin. *Clin Chem* 1993;39:2098–103. Yu H, Diamandis EP. Ultrasensitive time-resolved immunofluorometric assay of prostate-specific antigen in serum and preliminary clinical studies. *Clin Chem* 1993; 9:2108–14. Zhou AM, et al. Multiple forms of prostate-specific antigen in serum: differences in immunorecognition by monoclonal and polyclonal assays. *Clin Chem* 1993;39:2483–91.

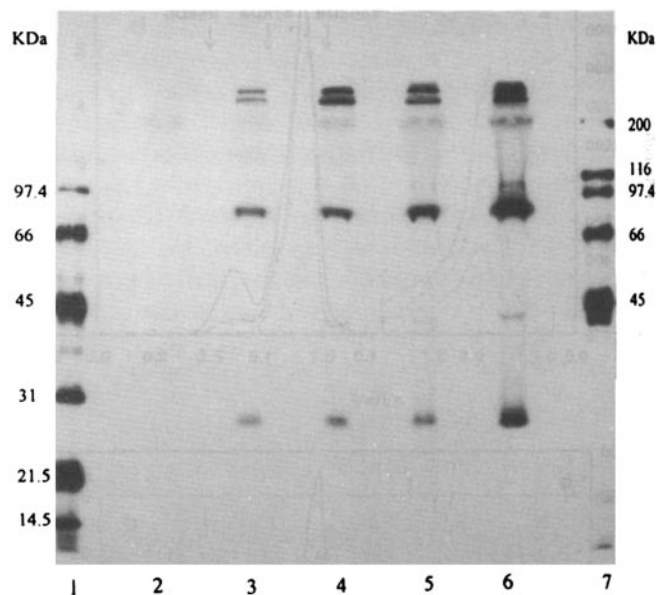

The rate of degradation of bone type I collagen can be estimated by a serum marker. Risteli J, et al. RIA for the pyridinoline cross-linked carboxy-terminal telopeptide of type I collagen: a new serum marker of bone collagen degradation. *Clin Chem* 1993;39:635–40.

A high-capacity insulin assay is published that does not measure proinsulin. Andersen L, et al. Enzyme immunoassay for intact human insulin in serum or plasma. *Clin Chem* 1993;39:578–82.

*O is for oxidation.* A simple and reproducible method for measuring thiobarbituric acid-reactive substances in serum is proposed to screen for factors responsible for increased lipid peroxidation. Wasowicz W, et al. Optimized steps in fluorometric determination of thiobarbituric acid-reactive substances in serum: importance of extraction pH and influence of sample preservation and storage. *Clin Chem* 1993;39:2522–6.

Apartheid ends in South Africa.

Mosaic, the first user-friendly graphical interface to the World Wide Web, is introduced.

The North American Free Trade Agreement is ratified.

Kary Mullis wins the Nobel Prize for the invention of PCR.

**1994** *One carbon transfer back on the map.* Homocysteine is shown to be a risk factor for coronary artery disease. A HPLC procedure with fluorescence detection is developed for the rapid determination of this analyte in human serum and plasma. Wu LL, et al. Plasma homocyst(e)ine as a risk factor for early familial coronary artery disease *Clin Chem* 1994;40:552–61. Jacobsen DW, et al. Rapid HPLC determination of total homocysteine and other thiols in serum and plasma: sex differences and correlation with cobalamin and folate concentrations in healthy subjects *Clin Chem* 1994;40:873–81.

*Protein markers and standards.* To address the problem of poor between-laboratory agreement for measurements of plasma proteins, a widely available, secondary reference material for plasma proteins that could be used to help standardize methods is developed [Whicher JT, et al. New international reference preparation for proteins in human serum (RPPHS). *Clin Chem* 1994;40:934–8]. Cystatin C is shown to be an attractive alternative to creatinine for estimation of glomerular filtration rate (Kyhse-Andersen L, et al. Serum cystatin C, determined by a rapid, automated particle-enhanced turbidimetric method, is a better marker than serum creatinine for glomerular filtration rate *Clin Chem* 1994;40:1921–6). An ELISA for measuring type I collagen degradation products in urine is used as a marker for bone resorption (Bonde M, et al. Immunoassay for quantifying type I collagen degradation products in urine evaluated. *Clin Chem* 1994;40:2022–5). cTnT is shown to be a more sensitive indicator of

myocardial injury than CK-MB (Wu AH, et al. Cardiac troponin-T immunoassay for diagnosis of acute myocardial infarction. *Clin Chem* 1994;40:900–7).

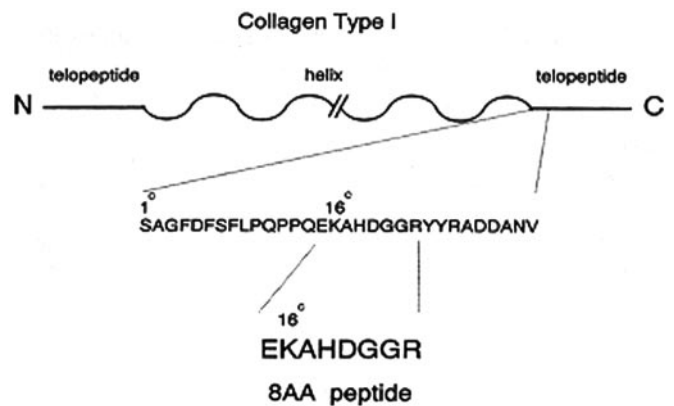

*Other biomarkers.* *Clinical Chemistry* publishes a series of papers on the subject of biomarkers of chemical exposure and the role of the clinical laboratory in environmental health issues. *Clin Chem* 1994;40:1359–475.

First Virtual, the first cyberbank, opens for business. The Chunnel opens between England and France.

**1995** *Four Kringles to go.* Antibody specificity and apo(a) size heterogeneity can significantly affect Lp(a) measurements; this of importance in interpreting results from both clinical and epidemiologic studies. Marcovina SM, et al. Effect of the number of apolipoprotein(a) kringle 4 domains on immunochemical measurements of lipoprotein(a). *Clin Chem* 1995;41:246–55.

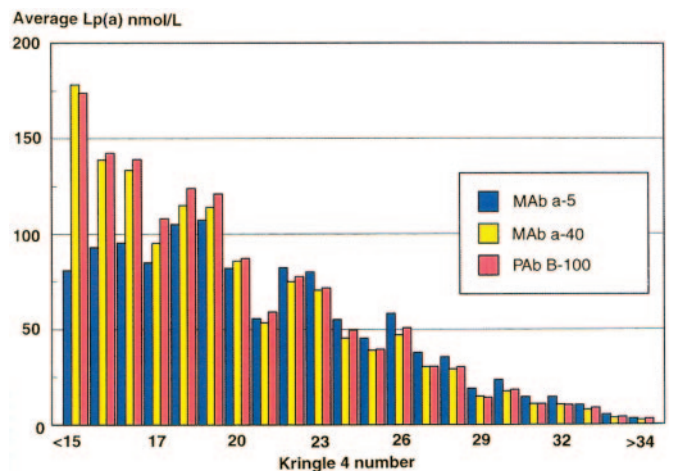

*Antioxidants uncorked.* The antioxidant effects of various flavonoids and other polyphenols are studied

using a chemiluminescent assay of serum antioxidant capacity (SAOC) in individuals ingesting red wine, white wine, and high doses of vitamin C. Whitehead TP, et al. Effect of red wine ingestion on the antioxidant capacity of serum. *Clin Chem* 1995;41:32–5.

**Free at last.** Studies on the accuracy of free PSA assays and assays of the PSA-ACT complex are published. Pettersson K, et al. Free and complexed prostate-specific antigen (PSA): in vitro stability, epitope map, and development of immunofluorometric assays for specific and sensitive detection of free PSA and PSA- $\alpha_1$ -antichymotrypsin complex. *Clin Chem* 1995;41:1480–8.

**First commercial homocysteine assay.** A totally automated fluorescence polarization immunoassay for homocysteine, with no pretreatment or chromatographic steps, is described. Shipchandler MT, Moore EG. Rapid, fully automated measurement of plasma homocyst(e)ine with the Abbott IMx analyzer. *Clin Chem* 1995;41:991–4.

**Troponins: better than CK-MB?** Mair J, et al. Equivalent early sensitivities of myoglobin, creatine kinase MB mass, creatine kinase isoform ratios, and cardiac troponins I and T for acute myocardial infarction. *Clin Chem* 1995;41:1266–72. Bhayana V, et al. Discordance between results for serum troponin T and troponin I in renal disease. *Clin Chem* 1995;41:312–7. Bodor GS, et al. Cardiac troponin-I is not expressed in fetal and healthy or diseased adult human skeletal muscle tissue. *Clin Chem* 1995;41:1710–5.

**How many times must I say NO?** Plasma nitrite and nitrate are studied as markers for the activity of nitric oxide synthase and the production of nitric oxide radicals. Moshage H, et al. Nitrite and nitrate determinations in plasma: a critical evaluation. *Clin Chem* 1995;41:892–6.

A car bomb destroys the Murrah Federal Building in Oklahoma City.  
The Metropolitan Opera installs screens on audience seats to display captions.  
The World Trade Organization is established.

**1996 ApoB.** Men and women with apoB concentrations  $>1.20$  g/L are shown to be more likely to have CHD than individuals with apoB concentrations  $<1.00$  g/L. Contois JH. Reference intervals for plasma apolipoprotein B determined with a standardized commercial immunoturbidimetric assay: results from the Framingham Offspring Study. *Clin Chem* 1996;42:515–23.

**Measuring a magic bullet.** A RIA is developed for leptin, the gene product absent in ob/ob mice, and a negative regulator of adiposity. Plasma leptin concentrations are demonstrated to be correlated directly with body mass index in humans. Ma Z, et al. RIA of leptin in human plasma. *Clin Chem* 1996;42:942–6.

**Ultrasensitive PSA.** Monitoring of post-radical prostatectomy patients reveals significant PSA changes at concentrations undetectable by conventional methods. Ferguson RA, et al. Ultrasensitive detection of prostate-specific antigen by a time-resolved immunofluorometric assay and the Immulite immunochemiluminescent third-generation assay: potential applications in prostate and breast cancers. *Clin Chem* 1996;42:675–84.

**Eat your veggies.** Supplementation of the diet with folic acid is demonstrated to cause a decrease in plasma homocysteine concentrations; human reference intervals for homocysteine are defined. Rasmussen K. Age- and gender-specific reference intervals for total homocysteine and methylmalonic acid in plasma before and after vitamin supplementation *Clin Chem* 1996;42:630–6.

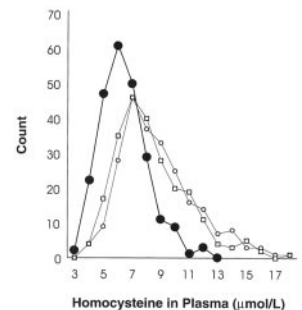

**Noninvasive.** Fecal immunoreactive elastase is found to be a new marker of pancreatic function. Stein J, et al. Immunoreactive elastase I: clinical evaluation of a new noninvasive test of pancreatic function. *Clin Chem* 1996;42:222–6.

**PCR automated.** Amplification and detection of target nucleic acids are automated, making diagnostic PCR routine for a variety of infectious diseases. The system contains a thermal cycler, regulated heating/cooling blocks, incubator, magnetic particle washer, pipettor, and photometer. DiDomenico N, et al. COBAS AMPLICOR: fully automated RNA and DNA amplification and detection system for routine diagnostic PCR. *Clin Chem* 1996;42:1915–23.

*Clinical Chemistry* adopts a new cover with an abstract design suggesting molecules, globes, or possibly, the harmony of the spheres. New typography is adopted, and

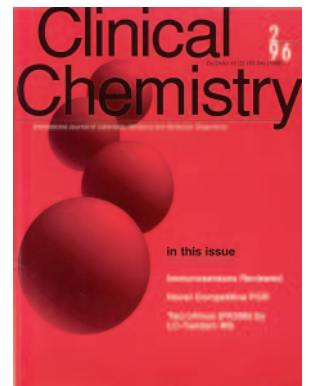

a subtitle, "International Journal of Laboratory Medicine and Molecular Diagnostics", is added, reflecting the Journal's editorial and geographic perspectives.

Bomb explosion during the Olympics in Atlanta kills one person and injures more than 100. Britain is alarmed by an outbreak of "mad cow" disease. The FBI arrests the suspected Unabomber. Ian Wilmut and his colleagues at the Roslin Institute in Edinburgh clone the sheep Dolly.

**1997** *Clinical Chemistry* publishes a detailed summary of classified documents from the former German Democratic Republic (East Germany) dealing with government promotion of the use of drugs in high-performance sports. The report details the use of anabolic steroids by athletes in a variety of sports, but their use with adolescent girls, particularly swimmers beginning at 14 years of age, is frightening: "The treatment of young girls with androgenic hormones was especially rewarding in the medal-rich swimming events, where it secured consistent international success." The authors caution parents around the world: "Even the androgenization of young girls has been, and remains, a documented practice in the sport system of countries outside the GDR and the socialist system." Franke WW, Berendonk B. Hormonal doping and androgenization of athletes: a secret program of the German Democratic Republic government. *Clin Chem* 1997;43:1262-79.

**MS-MS.** The first results are published for real-time newborn screening using tandem mass spectrometry. Chace DH, et al. Rapid diagnosis of MCAD deficiency: quantitative analysis of octanoylcarnitine and other acylcarnitines in newborn blood spots by tandem mass spectrometry. *Clin Chem* 1997;43:2106-13.

**Cardiac troponins reach prime time.** The clinical utility of cardiac troponins continues to expand, and methods are further improved. *Clinical Chemistry* publishes several studies that help to clarify the presence of troponins in regenerating tissue and in dialysis patients. Troponin I is shown to be released in the bloodstream of patients not in the free form, but rather as a complex. Bodor GS, et al. Cardiac troponin T composition in normal and regenerating human skeletal muscle. *Clin Chem* 1997;43:476-84. Katrukha AG, et al. Troponin I is released in bloodstream of patients with acute myocardial infarction not in free form but as complex. *Clin*

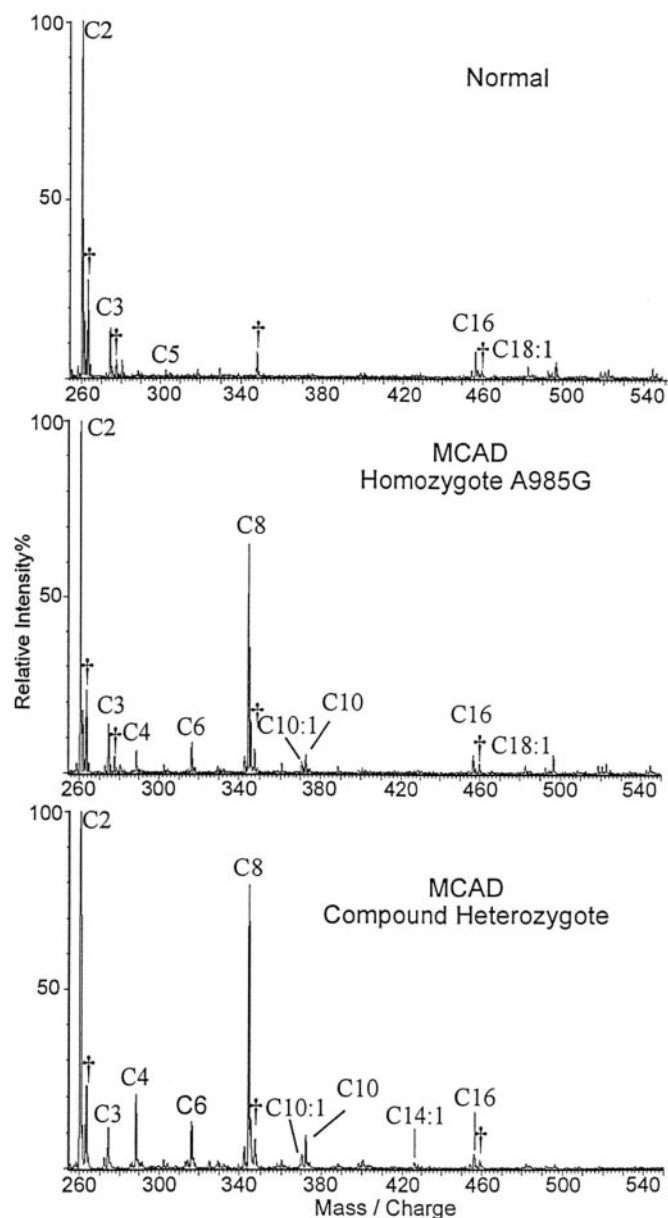

*Chem* 1997;43:1379-85. Muller-Bardorff M, et al. Improved troponin T ELISA specific for cardiac troponin T isoform: assay development and analytical and clinical validation. *Clin Chem* 1997;43:458-66. Baum H, et al. Evaluation and clinical performance of a second generation cardiospecific assay for troponin T. *Clin Chem* 1997;43:1877-84. McLaurin MD, et al. Cardiac troponin I, cardiac troponin T, and creatine kinase MB in dialysis patients without ischemic heart disease: evidence of cardiac troponin T expression in skeletal muscle. *Clin Chem* 1997;43:976-82. Apple FS, et al. Improved detection of minor ischemic myocardial injury with measurement of serum cardiac troponin I. *Clin Chem* 1997;43:2047-51.

**Multiplexed.** An analysis platform for flow cytometric analysis of microsphere-based assays that performs simultaneous measurement of up to 64 different analytes is described. The system consists of distinct sets of fluorescent microspheres. Fulton RJ, et al. Advanced multiplexed analysis with the FlowMetrix™ system. *Clin Chem* 1997;43:1749–56.

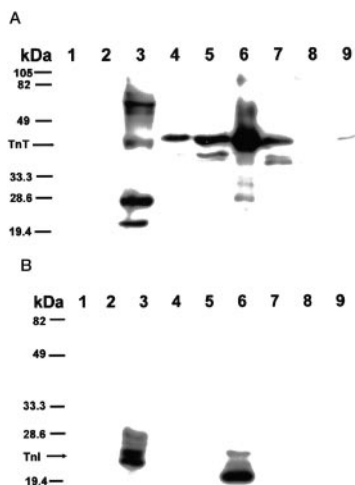

A single-step method for factor V Leiden genotyping is published. It uses rapid-cycle PCR and simultaneous fluorescence analysis with resonance energy transfer probes. Lay MJ, Wittwer CT. Real-time fluorescence genotyping of factor V Leiden during rapid-cycle PCR. *Clin Chem* 1997;43:2262–7.

**MALDI-TOF.** A new method for the reliable identification of localized variations in DNA by detection of associated diagnostic products with matrix-assisted laser desorption ionization time-of-flight mass spectrometry is described. Braun A, et al. Detecting CFTR gene mutations by using primer oligo base extension and mass spectrometry. *Clin Chem* 1997;43:1151–8.

The world reels from the news of Princess Diana's death.

Hong Kong returns to Chinese rule.

Nobel Prizes in Chemistry are awarded to Paul D. Boyer, Jens C. Skou, and John E. Walker for their studies of the enzymatic mechanisms underlying the synthesis of ATP.

**1998** The AACC Subcommittee on cTnI Standardization concludes that commercially available assays are useful for detection of cardiac injury; however, differences in cTnI results are attributable to a lack of standardization and heterogeneity in the cross-reactivities of antibodies to various troponin forms (Wu AHB, et al. Characterization of cardiac troponin subunit release into serum after acute myocardial infarction and comparison of assays for troponin T and I. *Clin Chem* 1998;44:1198–208). Cardiac troponins T and I collected shortly after ischemic symptoms are used for predicting clinical outcomes (Christenson RH, et al.

Cardiac troponin T and cardiac troponin I: relative values in short-term risk stratification of patients with acute coronary syndromes. *Clin Chem* 1998;44:494–501).

An approach for screening for deficiency of steroid 21-hydroxylase and congenital adrenal hyperplasia is published. Krone N, et al. Comprehensive analytical strategy for mutation screening in 21-hydroxylase deficiency. *Clin Chem* 1998;44:2075–82.

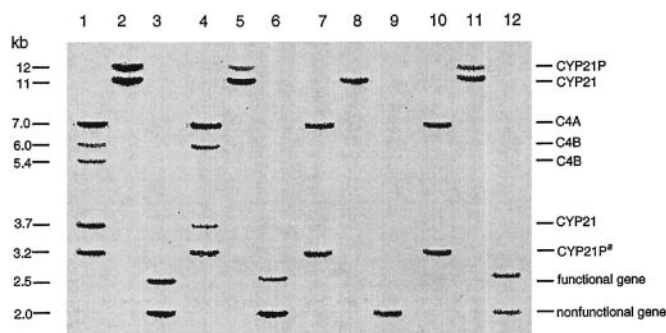

**Lab-on-a-chip.** A glass microchip is described in which reagents and serum samples for competitive immunoassay can be mixed, reacted, separated, and analyzed. Chiem NH, Harrison DJ. Microchip systems for immunoassay: an integrated immunoreactor with electrophoretic separation for serum theophylline determination. *Clin Chem* 1998;44:591–8.

[www.clinchem.org](http://www.clinchem.org): *Clinical Chemistry goes online!* The full text of the Journal is available to all subscribers; content from the previous year is also available. Abstracts and titles are available, starting with issues appearing after 1964.

Eleven European Union countries agree on a single currency, the Euro.

The US Department of Justice and 20 US states file an antitrust case against Microsoft.

**1999** Hyperglycosylated hCG is shown to be a new marker for Down syndrome screening; its measurement is claimed to improve the performance of screening protocols [Cole LA, et al. Hyperglycosylated human chorionic gonadotropin (invasive trophoblast antigen) immunoassay: a new basis for gestational down syndrome screening. *Clin Chem* 1999;45:2109–19]. Potential problems in measuring hCG are also revealed (Cole LA, et al. False-positive hCG assay results leading to unnecessary surgery and chemotherapy and needless occurrences of diabetes and coma. *Clin Chem* 1999;45:313–4).

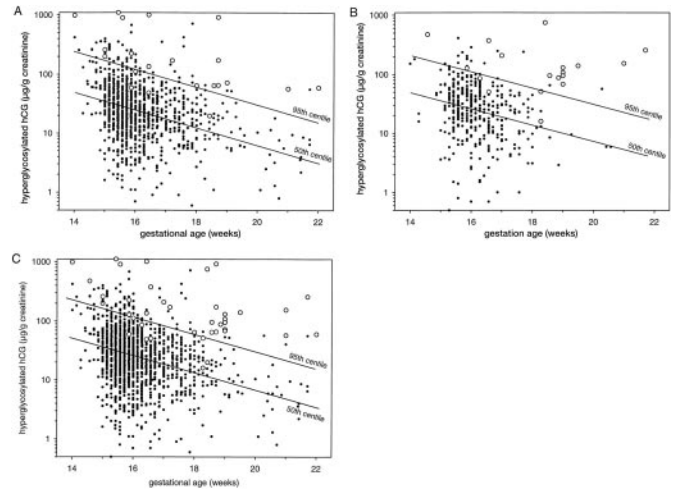

**Consensus on use of cardiac markers.** Recommendations are made in four areas: triage of patients with chest pain; acute coronary syndromes; clinical applications other than acute MI and research; and assay platforms and markers of acute myocardial infarction. Wu AHB, et al. National Academy of Clinical Biochemistry standards of laboratory practice: recommendations for the use of cardiac markers in coronary artery diseases. *Clin Chem* 1999;45:1104–21.

Circulating fetal DNA is suggested as a marker for the diagnosis and monitoring of preeclampsia. Lo YMD, et al. Quantitative abnormalities of fetal DNA in maternal serum in preeclampsia. *Clin Chem* 1999;45:184–8.

**Clinical efficiency of hs-CRP.** Rifai N, et al. Clinical efficacy of an automated high-sensitivity C-reactive protein assay. *Clin Chem* 1999;45:2136–41.

A sensitive method for mutation detection, software-optimized DHPLC, is published. Jones AC, et al. Optimal temperature selection for mutation detection by denaturing HPLC and comparison to single-stranded conformation polymorphism and heteroduplex analysis. *Clin Chem* 1999;45:1133–40.

The US Senate convenes the impeachment trial of President Clinton.  
The number of Internet users worldwide reaches 150 million.

**2000** **Promising tools in infectious disease.** A PCR-based assay is developed for the rapid detection and identification of group B streptococci. Ke D, et al. Development of conventional and real-time PCR assays for the



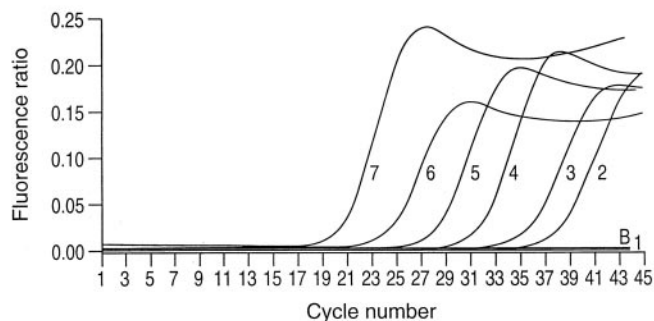

rapid detection of group B streptococci. *Clin Chem* 2000;46:324–31.

Measurement of expression of hTERT, which codes for the catalytic subunit of telomerase, is shown to have the potential to discriminate between healthy and tumor cells. de Kok JB, et al. Real-time quantification of human telomerase reverse transcriptase mRNA in tumors and healthy tissues. *Clin Chem* 2000;46:313–8.

**Evidence and accuracy.** Because many published reports on diagnostic accuracy of medical tests fail to adhere to clinical epidemiologic standards, key items for inclusion in such published reports are proposed (Bruns DE, et al. Toward a checklist for reporting of studies of diagnostic accuracy of medical tests. *Clin Chem* 2000; 46:893–5). The elements of evidence-based laboratory medicine are reviewed (Price CP. Evidence-based laboratory medicine: supporting decision-making. *Clin Chem* 2000;46:1041–50).

**Liver diseases.** Performance characteristics for tests commonly used to identify acute and chronic hepatic injury are critically reviewed and recommendations made. Dufour DR, et al. Diagnosis and monitoring of hepatic injury. I. Performance characteristics of laboratory tests. *Clin Chem* 2000;46:2027–49. Dufour DR, et al. Diagnosis and monitoring of hepatic injury. II. Recommendations for use of laboratory tests in screening, diagnosis, and monitoring. *Clin Chem* 2000;46:2050–68.

**Homeland security.** The capabilities of clinical laboratories in supporting chemical and biological counterterrorism programs are reviewed, so that clinical laboratories can identify their current resources and state of readiness. Jortani SA, et al. The role of the clinical laboratory in managing chemical or biological terrorism. *Clin Chem* 2000;46:1883–93.

Y2K does not cause the world's computers to fail.  
George W. Bush defeats Al Gore for the US  
presidency after resolution of a disputed vote  
count in Florida.  
The *Saccharomyces cerevisiae* genome is sequenced.

**2001** A new molecular assay with increased sensitivity and precision helps to clarify vascular endothelial growth factor-mediated angiogenesis. Wellmann S, et al. Specific reverse transcription-PCR quantification of vascular endothelial growth factor (VEGF) splice variants by LightCycler technology. *Clin Chem* 2001;47: 654–60.

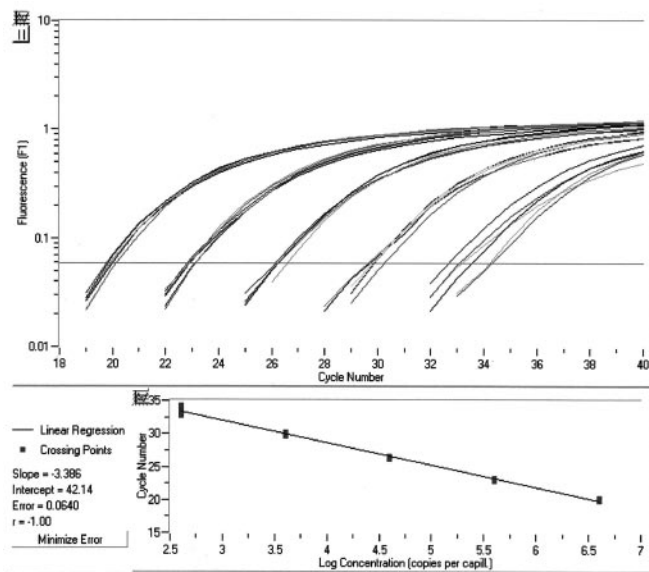

Anti-cyclic citrullinated peptide antibodies are used in the identification of patients with suspected rheumatoid arthritis. Bizzaro N, et al. Diagnostic accuracy of the anti-citrulline antibody assay for rheumatoid arthritis. *Clin Chem* 2001;47:1089–93.

**MS/NBS.** Tandem mass spectrometry is used by newborn-screening programs to screen dried blood spots for >20 markers of disease in a single assay. Zytkevich TH, et al. Tandem mass spectrometric analysis for amino, organic, and fatty acid disorders in newborn dried blood spots: a two-year summary from the New England newborn screening program. *Clin Chem* 2001; 47:1945–55.

**High-c.** cRP is shown to have prognostic utility in patients with acute coronary syndromes and to be a strong independent predictor of future coronary events in healthy subjects. Rifai N, Ridker PM. High-sensitivity C-reactive protein: a novel and promising marker of coronary heart disease. *Clin Chem* 2001;47:403–11. Roberts WL, et al. Evaluation of nine automated high-sensitivity c-reactive protein methods: implications for clinical and epidemiological applications. *Clin Chem* 2001;47:418–25. Rifai N, et al. Proposed cardiovascular

risk assessment algorithm using high-sensitivity C-reactive protein and lipid screening. *Clin Chem* 2001;47:28–30. Ockene IS, et al. Variability and classification accuracy of serial high-sensitivity c-reactive protein measurements in healthy adults. *Clin Chem* 2001;47:444–50.

J. Stanton King, Editor Emeritus of *Clinical Chemistry*, passes away.

Online submission and reviewing of manuscripts are introduced.

On 9/11, terrorists attack the World Trade Center and the Pentagon.  
US and British forces launch a bombing campaign against the Taliban government in Afghanistan.  
Anthrax-laced letters are sent to the media and to government officials in the US.

**2002** LDL-cholesterol measurements are important in the evaluation and management of hypercholesterolemia. A report evaluates the new family of homogeneous assays for direct determination of LDL-C. Nauck M, et al. Methods for measurement of LDL-cholesterol: a critical assessment of direct measurement by homogeneous assays vs calculation. *Clin Chem* 2002;48:236–54.

**Microarrays and microbes.** Protein microarrays incorporating microbial antigens are used to simultaneously determine antibodies directed against *Toxoplasma gondii*, rubella virus, cytomegalovirus, and herpes simplex virus types 1 and 2. Mezzasoma L, et al. Antigen microarrays for serodiagnosis of infectious diseases. *Clin Chem* 2002;48:121–30.

**Practice, practice, practice.** Multiple laboratory tests are critically reviewed in support of the diagnosis and management of patients with diabetes mellitus. Practice guidelines for the most appropriate use of tumor markers are reviewed. Sacks DB, et al. Guidelines and recommendations for laboratory analysis in the diagnosis and management of diabetes mellitus. *Clin Chem* 2002;48:436–72. Sturgeon C. Practice guidelines for tumor marker use in the clinic. *Clin Chem* 2002;48:1151–9.

**To err is human.** The Institute of Medicine estimates that as many as 98 000 people die in any given year from medical errors that occur in US hospitals. *Clinical*

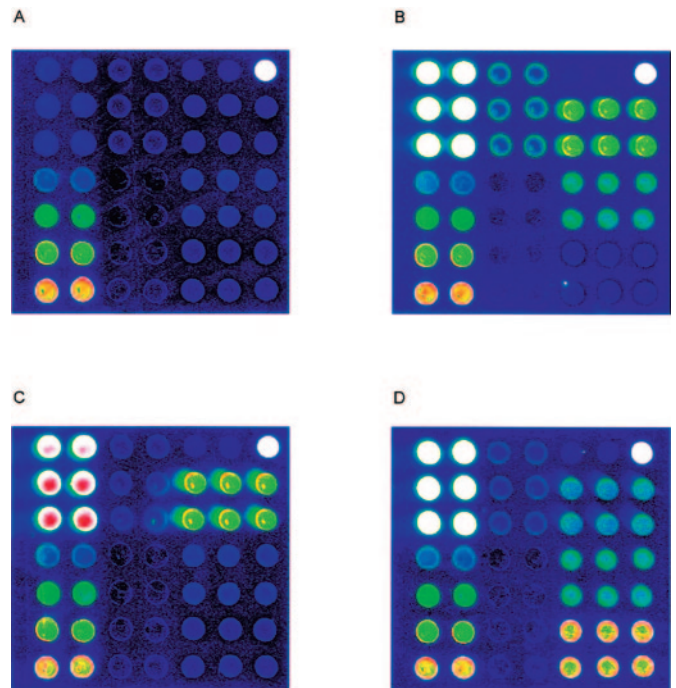

*Chemistry* publishes an examination of those errors that are attributable to the laboratory. Bonini P, et al. Errors in laboratory medicine. *Clin Chem* 2002;48:691–8.

**Proteomics.** SELDI mass spectrometry and bioinformatics tools are used to screen for potential tumor biomarkers. Li J, et al. Proteomics and bioinformatics approaches for identification of serum biomarkers to detect breast cancer. *Clin Chem* 2002;48:1296–304.

Chechen rebels take 763 hostages in a Moscow theater.

Terrorists detonate massive bombs in two nightclubs in Kuta, Bali.

Quaoar is discovered in our solar system.

It is estimated that 11% of the world population is on line; for the English-speaking world, the proportion is 43%.

**2003** **Start with STARD.** A protocol for evaluating the completeness and accuracy of biomedical research is published. A checklist and flow diagram will aid researchers in improving the quality of reporting of studies of diagnostic accuracy; this will benefit clinicians, researchers, reviewers, journals, and the public. Bossuyt PM, et al. Towards complete and accurate reporting of studies of diagnostic accuracy: the STARD initiative. *Clin Chem* 2003;49:1–6; Bossuyt PM, et al. The STARD statement for reporting studies of diagnostic

accuracy: explanation and elaboration. *Clin Chem* 2003; 49:7–18.

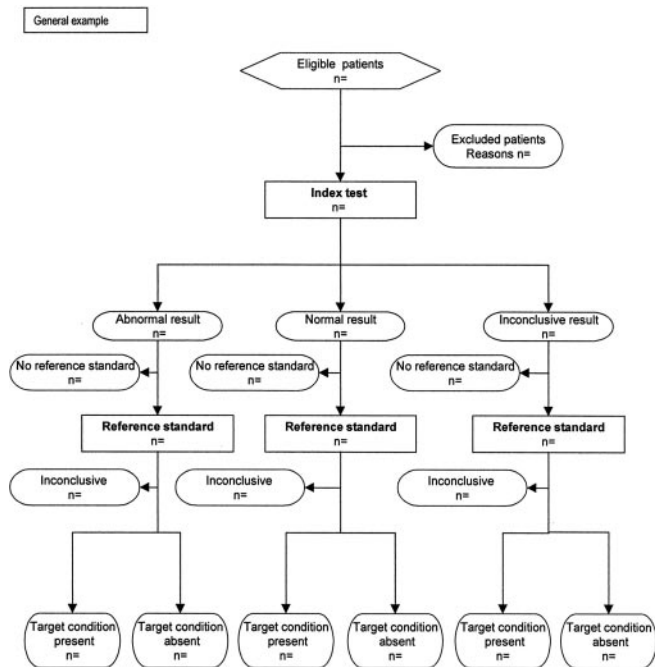

**SARS.** The highly infectious severe acute respiratory syndrome (SARS) emerges in East Asia. Within a few months of its outbreak, *Clinical Chemistry* publishes a PCR-based technique to detect the viral agent associated with the disease. Poon LLM, et al. Rapid diagnosis of a coronavirus associated with severe acute respiratory syndrome (SARS). *Clin Chem* 2003;49:953–5.

**ER.** Recommendations for the use of clinical laboratory tests to support patients exposed to drugs and toxins are published. Wu AHB, et al. National Academy of Clinical Biochemistry laboratory medicine practice guidelines: recommendations for the use of laboratory tests to support poisoned patients who present to the emergency department. *Clin Chem* 2003;49:357–79.

**Publish ahead of print.** Late in 2003, authors' proofs of accepted articles are published online as they become available. The proofs are on line 3–5 weeks before their publication in print or in their final online format, thus allowing access to the latest information in the field.

The US and UK strike military targets in Baghdad and invade Iraq.  
 The last old-style Volkswagen Beetle is produced in Puebla, Mexico.  
 WHO issues a global alert on SARS.

**2004** *Clinical Chemistry* turns 50. *Clinical Chemistry* marks its 50th year of continuous publication. Bruns, DE, Rej R. Fifty years of *Clinical Chemistry* [Editorial]. *Clin Chem* 2004;50:1–2.



**Experts on homocysteine.**

Leading authorities voice opinions and recommendations on aspects of total homocysteine determinations in clinical practice and in the research setting, as well as on the relevance of homocysteine measurements as diagnostic or screening tests. Refsum H, et al. Facts and recommendations about total homocysteine determinations: an expert opinion. *Clin Chem* 2004;50:3–32.

**SNPs in a snap.** SNP genotyping is achieved through high-resolution melting analysis. The closed-tube method is rapid and inexpensive, requiring only PCR, a DNA dye, and melting instrumentation; it can be completed in <2 min after completion of PCR. Liew M, et al. Genotyping of single-nucleotide polymorphisms by high-resolution melting of small amplicons. *Clin Chem* 2004;50:1156–64.

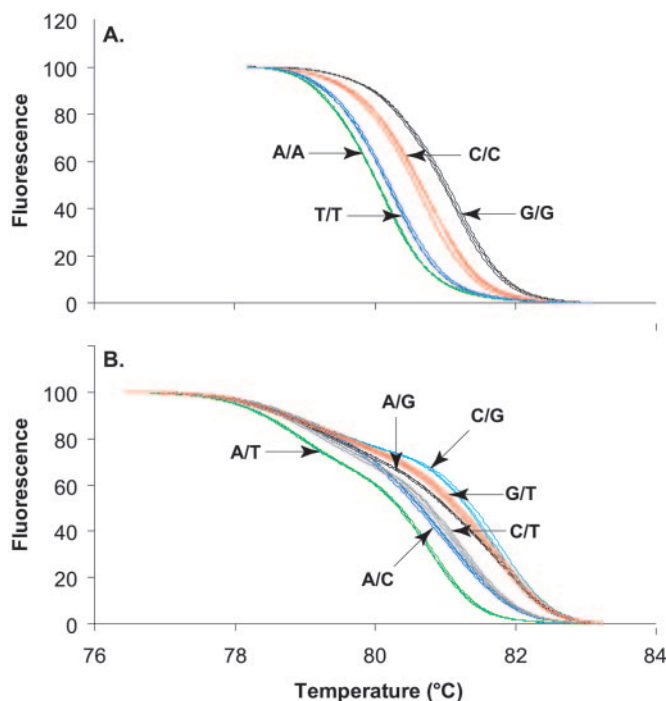

**Evaluation of BNP.** Using evidence-based laboratory medicine principles, the diagnostic accuracy and prognostic relevance of the measurement of natriuretic peptides are evaluated. Clerico A, et al. Diagnostic accuracy and prognostic relevance of the measurement of cardiac natriuretic peptides: a review. *Clin Chem* 2004;50:33–50. The performance of different natriuretic peptides to diagnose mild forms of left ventricular dysfunction is evaluated. Hammerer-Lercher A, et al. Natriuretic peptides as markers of mild forms of left ventricular dysfunction: effects of assays on diagnostic performance of markers. *Clin Chem* 2004;50:1174–83.

Impact factor of *Clinical Chemistry* increases to 5.538.

**Paperless Clinical Chemistry.** The Journal embarks on a program to have all of its content—from Volume 1, page 1 to the present (nearly 100 000 printed pages)—available on line. Previously, full content availability was limited to articles published in 1997 (Volume 43) and later.

Vladimir Putin wins a second term as President of Russia.

The European Union expands to include Poland, Lithuania, Latvia, Estonia, the Czech Republic, Slovakia, Slovenia, Hungary, Malta, and Cyprus. George W. Bush elected to a second term as President of the United States.

### Acknowledgments

I am grateful to past and present members of the Editorial Board of *Clinical Chemistry* who offered helpful suggestions in the preparation of this review. Particular thanks go to the Executive Committee of the Editorial Board and to our Publisher, Mac Fancher, and our Editor, Dave Bruns, for their helpful suggestions and encouragement. I would also like to thank BonoTom Studio, Inc., for rendering the collages of historic events and Christina McIntyre, Barbara Paternoster, and Valarie Watersun for their

invaluable assistance in collecting and preparing items for inclusion.

### References

1. Bruns, DE, Rej R. Fifty years of *Clinical Chemistry* [Editorial]. *Clin Chem* 2004;50:1–2.
2. Friedman MM. *Clinical Chemistry*: the history of a journal. *Clin Chem* 1973;19:1315–7.
3. Caraway WT. Recollections of the AACC and related activities, continued. *Clin Chem* 1999;45:750–2.
4. Roethel DAH. Some historical perspectives on AACC. *Clin Chem* 1997;43:1232–5.
5. King JS. *Clinical Chemistry*: a fragmentary history (1969–1977). *Clin Chem* 1994;40:2106–10.
6. Garfield E. Citation Classics in *Clinical Chemistry* highlight the cumulative impact of useful methods—a tribute to Editor John [sic] Stanton King. Essays of an information scientist: science reviews, journalism inventiveness and other essays, Vol. 14, p 147–52, 1991. Current Contents September 16 1991;37:3–8. [also available online <http://www.garfield.library.upenn.edu/essays/v14p147y1991.pdf> (accessed July 2004)].
7. Rej R. They use enzymes for everything! *Clin Chem* 1998;44:1149–53.
8. Peters T Jr. Citation classics in intermediary metabolism. *Clin Chem* 1998;44:1371–5.
9. Price CP. The evolution of immunoassay as seen through the journal *Clinical Chemistry*. *Clin Chem* 1998;44:2071–4.
10. Gotto AM, Cooper GR. Citation classics in lipid measurement and applications. *Clin Chem* 1998;44:2234–7.
11. Bruns DE. The clinical chemist. *Clin Chem* 1998;44:1791–4.
12. Burtis CA, Klein B, Ladenson J, Rosenfeld L, Savory J, Sunshine I. Fifty years of *Clinical Chemistry*, three pioneering editors. *Clin Chem* 2004;50:1871–7.
13. Babson AL. Correspondence: reference standards and substrates for alkaline phosphatase. *Clin Chem* 1968;14:75–6 [reply by Bowers GN Jr, Kelley ML, McComb RB. *Clin Chem* 1968;14:76–8].
14. Smithsonian Institution. From carbons to computers: the changing American office. [http://www.smithsonianeducation.org/educators/lesson\\_plans/carbons/1960.html](http://www.smithsonianeducation.org/educators/lesson_plans/carbons/1960.html) (accessed June 2004).
15. Seligson D. Men and machines. *Clin Chem* 1962;8:203–7.
16. Bruns DE. The clinical chemist. *Clin Chem* 2004;50:983–4.
17. Washington DC principles for free access to science. <http://www.dcprinciples.org/> (accessed August 2004).
18. Jellum E, Stokke O, Eldjarn L. Combined use of gas chromatography, mass spectrometry, and computer in diagnosis and studies of metabolic disorders. *Clin Chem* 1972;18:800–9.