

# Effects of Valerianae Radix et Rhizoma extract on psychological stress in mice

Jeong Suk Kim, Jeong Deok Ahn<sup>1</sup>, Su-In Cho<sup>2</sup>

Department of Health Service and Population Research, Institute of Psychiatry, King's College of London, London, UK, <sup>1</sup>Department of Sport Science, College of Sport Science, Pusan National University, <sup>2</sup>Department of Korean Medicine, School of Korean Medicine, Pusan National University, Yangsan, Gyeongnam, Republic of Korea

Submitted: 07-04-2014

Revised: 09-06-2014

Published: 12-03-2015

## ABSTRACT

**Background:** The aim of this study was to identify the effects of Valerianae Radix et Rhizoma water extract (VRe) originated from *Valeriana fauriei* Briquet on reducing psychological stress (PS) on mice. **Objective:** Mice were put under PS with communication box method: Restraining mice and forcing to see other mice underfoot shock stress. **Materials and Methods:** Measurements on plasma corticosterone, noradrenaline and lipid peroxidation, and elevated plus-maze (EPM) tests were carried out to determine the effect of VRe administration on physiological and behavioral responses of mice. **Results:** VRe showed anxiolytic effects in plasma corticosterone, noradrenaline, and EPM transfer latency levels, but it did not show any significant effects on the other indicators. **Conclusion:** *V. fauriei*, which has been used as a natural anxiolytic drug, exerts positive effects in the communication box induced PS in mice.

**Key words:** Communication box, psychological stress, *Valeriana fauriei* briquet, valerianae radix et rhizoma

### Access this article online

**Website:**

www.phcog.com

**DOI:**

10.4103/0973-1296.153093

**Quick Response Code:**

## INTRODUCTION

This study aimed at investigating the effectiveness of Valerianae Radix et Rhizoma (VRe) originated from *Valeriana fauriei* Briquet on mice under psychological stress (PS). It is well-recognized that exposure to a situation perceived as threatening or excessively demanding leads to the release of chemicals which can help cope with the stressor.<sup>[1,2]</sup> But excessive response to a stressor may cause elevated inflammation, and elevations in inflammatory markers in turn implicates the development and progression of many chronic diseases including cardiovascular disease.<sup>[3]</sup>

*Valeriana fauriei* is a perennial herb found in North America, Europe, and Asia, and the genus *Valeriana* contains over 250 species with many more subspecies.<sup>[4]</sup> *V. fauriei*, a species of *Valeriana* genus, which contains over 250 species with many more subspecies, rich in China and Korea and has been used for 100s of years in folks.<sup>[5]</sup> Many of medicinal plants in *Valeriana* genus are widely used in popular medicine for centuries to treat sleep disorders,

anxiety, and epilepsy, and also can modulate anxiety and insomnia by interacting with different neurotransmitter systems.<sup>[6]</sup> Recently, it is being studied as a medication to enhance sleep of cancer patients receiving treatment, and known in different names such as garden valerian, Indian valerian, Pacific valerian, garden heliotrope, and VRe.<sup>[7-9]</sup>

Since VRe can induce sleep when orally dosed, it is often used as a natural sedative free of side effects. People have been prescribed with L-tryptophan (no longer available) and melatonin in the past, but they are now turning their eyes on Valerian roots as a more natural and effective sleep-inducing medication. There are numerous natural products from Valerian on the market, available in forms of tea, tincture or capsule. N-hexane extracts of VRe were thought to have more bioactive potentials in antidepressant activity,<sup>[4]</sup> but in Asian countries, water decoctions are more commonly used extracting methods in traditional and folk medicines. Therefore, we conducted this study to evaluate potential effects of VRe on PS in mice.

To mimic the human response to stress, we put mice under depression by repeated exposure to stress. This model has been used to replicate human reactions of hypothalamic-pituitary-adrenocortical system, that is elevated level of glucocorticoids (GCs),<sup>[10]</sup> and disruptions in sleep-wake cycle,<sup>[11]</sup> which typically represents circadian

**Address for correspondence:**

Prof. Su-In Cho,  
School of Korean Medicine, Pusan National University,  
Beomeo-ri, Mulgeum-eup, Yangsan,  
Gyeongnam 626-870, Republic of Korea.  
E-mail: sicho@pusan.ac.kr

rhythm. It has been suggested that chronic stress has a close relationship to disturbances in circadian rhythms involving physiology, endocrinology, and behavior.<sup>[12-16]</sup> It is also reported that exposure to chronic stress induces abnormal behavioral and physiological responses, such as decreased food intake, hyperthermia, and elevation of plasma GCs.<sup>[17,18]</sup> However, little research has been done on the long-term effects of chronic stress.

Various methods including immobilization, cold water immersion, and predictable/unpredictable electric foot shock (FS) were used to impose PS to mice, but the extent of solely PS is hard to determine exactly in these cases. Therefore, in the present study, the communication box method developed by Takaoka, Hara, and Ogawa was used to put mice under PS.<sup>[19]</sup> The effect of VRe administration on the stress levels using the markers above was studied.

## MATERIALS AND METHODS

### Animals

Male imprinting control region mice ( $20 \pm 2$  g) aged 5 weeks were obtained from the Daehan Biolink Co. Ltd, Republic of Korea. The animals were housed in  $64 \text{ cm} \times 64 \text{ cm} \times 40 \text{ cm}$  polypropylene cages at  $22^\circ\text{C} \pm 2^\circ\text{C}$  under a 12/12 h light-dark cycle with standard pellet diet and water *ad libitum* for 2 or 3 weeks prior to the experiment. The mice were randomly assigned into four groups: Control group (CON;  $n = 8$ ), (FS;  $n = 8$ ), (PS;  $n = 8$ ), and VRe treatment group (VT;  $n = 8$ ). All experiments were performed according to the Guidance for the Care and Use of Laboratory Animals of the National Institutes of Health.

### Preparation of valerianae radix et rhizoma water extract

Valerianae Radix et Rhizoma (300 g) was obtained from the special herb market (Songsan Herb, Gwangju, Republic of Korea) and identified by Dr. Gumsan Lee (College of Korean Medicine, Wonkwang University, Korea). Voucher specimens (201-HCG) were placed in the Herbarium of School of Korean Medicine, Pusan National University (Yongsan, Korea), and the material satisfies the quality control guidelines from Korean Food and Drug Administration. 300 g of VRe was boiled in 5,000 ml distilled water using a Herb Extractor (Dae Woong, Korea) at  $100^\circ\text{C}$  for 2 h, after which it was filtered using Whatman filter paper No. 3. The filtrate was freeze-dried to a powder (52.4 g), which was stored at  $4^\circ\text{C}$  until needed. The powder (VRe) was dissolved in water prior to oral administration. Mice were fed orally with the dose of 100 mg/kg/day for 5 days, and the dose was titrated with a maximum amount within the range of biological safety in the preliminary study.

### Measurements of total phenolic compounds and flavonoids contained in valerianae radix et rhizoma water extract

80  $\mu\text{l}$  of VRe (10 mg/ml) was mixed with 20  $\mu\text{l}$  of 50% folin-ciocalteu reagent, and 5 min add 100  $\mu\text{l}$  of 2% sodium carbonate solution and incubate for 30 min at room temperature. The absorbance of the reaction mixture was measured at 725 nm with ultraviolet (UV) spectrometer. All determination was performed in triplicate. The calibration curve was prepared by preparing tannic acid standard solutions at concentration 4–20  $\mu\text{l}/\text{ml}$  in water.

Diethylene glycol colorimetric method was conducted for flavonoids determination. 100  $\mu\text{l}$  of VRe (10 mg/ml) was mixed with 1 ml of diethylene glycol and 100  $\mu\text{l}$  of 1 N NaOH. It remained at  $37^\circ\text{C}$  for 1 h. The absorbance of the reaction mixture was measured at 420 nm with UV spectrometer. All determination was performed in triplicate. The calibration curve was prepared by preparing naringin standard solutions at concentration 0.4–20  $\mu\text{g}/\text{ml}$  in water. Total content (%) of flavonoids in VRe was calculated as naringin equivalent.

Total contents (%) of phenolic compound and flavonoids in VRe were calculated as tannic acid and naringin equivalent (TAE and NE), respectively.

$$\text{TAE} = ([C \times V] / M) \times 100$$

$$\text{NE} = ([C \times V] / M) \times 100$$

C = The concentration of naringin established from calibration curve mg/ml

V = Volume of extract (ml)

M = The weight of VRe (mg).

### High performance thin layer chromatography fingerprint of valerianae radix et rhizoma water extract

For quality assurance of VRe, chromatogram was obtained by high-performance thin-layer chromatography (HPTLC) method. Hexane, ethyl acetate and glacial acetic acid (65:35:0.5, v/v) were the developer solvents. VRe was loaded on the HPTLC plate beside valerianic acid ( $\text{C}_{15}\text{H}_{22}\text{O}_2$ ) standard, and the HPLC fingerprint image was detected with CAMAG HPTLC system with Wincat32 software [Figure 1]. Valerianic acid, soluble in ethanol, was not detected with HPTLC method in VRe water extract.

### Induction of stress

Physical and PS was induced by placing experimental animals in a communication box that consisted of two

different types of compartments (16 compartments, 16 cm × 16 cm each).<sup>[19]</sup> The communication box was set up with a grid floor of stainless rods (0.5 cm diameter, 1.3 cm spacing). Transparent plastic sheets were used to divide 16 compartments [Figure 2]. Electric shocks of 2 mA were applied for 10 s at intervals of 120 s for the duration of 1 h. This process was continued for 5 days. In four compartments, plastic plates were placed to avoid the electric shock. Mice were divided into four groups: CON, FS, PS, and VT. The VT group was orally dosed with VRe for 5 days during the stress period whereas the fourth group did not. It was observed that some FS mice jumped up and down to avoid the shock from time to time. All mice were returned immediately after the stress exposure.

### Transfer latency in elevated plus-maze test

To investigate the effect of VRe on mice behavior, all eight mice in each group (CON, FS, PS, and VT) were placed on an elevated plus-maze (EPM) after 5 days of treatment.<sup>[20]</sup> To explain the above EPM briefly, the maze consisted of two open arms (50 cm × 10 cm), two closed arms (50 cm × 10 cm × 15 cm), and a central square (10 cm × 10 cm), all placed 50 cm above the floor in a dimly lit room [Figure 3]. Every mouse was initially placed in the open arm facing the square and the time spent in open arm (transfer latency, [TL]), and frequency of entrance was measured for 300 s.

### Measurements

After the termination of the stress sessions, the mice were deprived of food for 24 h and were euthanized under ether anesthesia. We measured serum level of corticosterone, alanine aminotransferase (ALT), noradrenaline secretion in the dorsal cortex of the brain, and lipid peroxidation level.

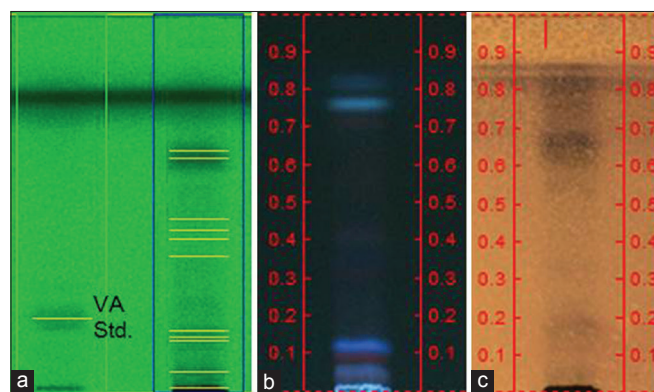

**Figure 1:** High-performance thin layer chromatography (HPTLC) images of the fingerprint of Valerianae Radix et Rhizoma water extract (VRe). VRe was loaded and developed in HPTLC plate, then detected with an ultraviolet or ((a) 254 nm; (b) 366 nm; (c) white light after p-anisaldehyde sprayed) valeric acid standard. Images were obtained with Camag Visualizer (Camag, Swiss)

### Plasma corticosterone assay

Plasma was separated by centrifugation of whole blood at 1500 ×g for 10 min at 4°C. The Immuchem <sup>125</sup>I Corticosterone RIA kit (ICN Biomedicals, Costa Mesa, CA) for laboratory mice and rats was used to measure the plasma corticosterone level. The samples were diluted with steroid diluent, incubated with <sup>125</sup>I-corticosterone and corticosterone antiserum at room temperature for 2 h. After the addition of precipitation solution, the samples were centrifuged 1000 ×g and 4°C for 15 min. Radioactivity of remaining pellet was measured with Gamma-counter GC-20. The level of corticosterone in plasma was obtained in ng/ml using standard solutions.

### Serum level of alanine aminotransferase assay

This was determined spectrophotometrically using the direct reading assay kits (Asan Pharmaceutical Co. Republic of Korea).

### Noradrenaline level of brain tissues assay

The whole brain was immediately removed and then washed with cold saline. Homogenizer in cold potassium phosphate buffer (50 mM; pH 7.4) was used to homogenize the dorsal cortex area of the washed brain. The noradrenaline level was measured by ion pairing reverse phase high-pressure liquid chromatography (HPLC) with electrochemical detection method.<sup>[21,22]</sup>

### Serum lipid peroxidation assay

Lipid peroxidation in hepatic tissue and serum was obtained by level of malondialdehyde (MDA) using the method of Uchiyama and Mihara.<sup>[23]</sup> To explain the above method briefly, 0.5 ml of homogenized sample in ice-cold 1.15% KCl (5 wt%/vol.) was added to 3 ml of 1% phosphoric acid

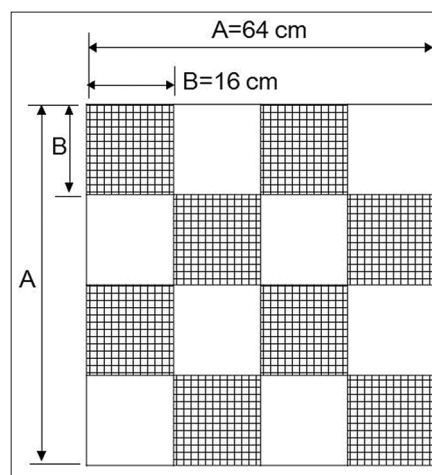

**Figure 2:** Scheme of the communication box. Foot shock mice were placed individually in the eight shaded areas (foot shock compartments). Psychological mice were placed in the eight solid areas the (nonfoot shock compartment). Foot shocks were delivered in shaded areas

and 1 ml of 0.6% thiobarbituric acid. After denaturation in boiling water bath for 45 min, 4 ml of n-butanol was added, and the mixture centrifuged at  $200 \times g$  for 20 min. The absorbance of upper organic layer was obtained using diode array spectrophotometer ( $\lambda = 535, 520 \text{ nm}$ ). Results were expressed in pmol/mg protein using freshly prepared MDA tetrahyalactal standard solutions. Protein was measured using the method developed by Bradford.<sup>[24]</sup>

#### Measurement of catalase activity

The catalase activity was determined by measuring the decomposition of  $\text{H}_2\text{O}_2$  according to the method of Aebi.<sup>[25]</sup> To explain the above method briefly, mouse serum was added in potassium phosphate buffer containing 10 mM potassium phosphate, 10 mM  $\text{MgCl}_2$  (pH 7.4 at  $30^\circ\text{C}$ ). Mixture was then centrifuged at  $3,000 \times g$  for 20 min at  $4^\circ\text{C}$  and the supernatant obtained was used for assaying the catalase activity.  $\text{H}_2\text{O}_2$  (final 10 mM) was added to potassium phosphate buffer containing a serum mixture equivalent to 100 g/ml of protein, and time-dependent decrease in absorbance at 240 nm was measured.

#### Measurement of Cu/Zn superoxide-dismutase activity

Cu/Zn superoxide dismutase activity in serum was determined using the xanthine/xanthine oxidase and cytochrome-c reduction assay.<sup>[26]</sup> Serum was added to assay mixture containing 200 mM potassium phosphate buffer (pH 7.4), 200 mM KCl, 0.5 mM xanthine, 0.126 U xanthine oxidase, and 0.1 mM cytochrome c. the assay was carried out in the presence of 1.5 mM KCN. The changes of optical density at 550 nm were monitored at room temperature.

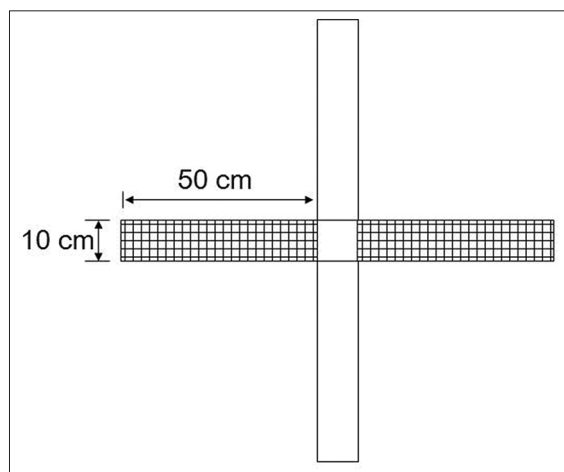

**Figure 3:** A bird's eye view of plus-maze. Solid area consisted of two opposite open arms, and shaded area crossed with two enclosed arms with 40 cm high walls. The arms were connected with a central square (10 cm  $\times$  10 cm) to give the apparatus a plus sign appearance

#### Measurement of glutathione peroxidase activity

Glutathione peroxidase activity in mouse serum was measured according to the method of Lawrence and Burk.<sup>[27]</sup> To explain the above method briefly, serum was added to assay mixture containing 100 mM potassium phosphate buffer (pH 7.0), 10 mM  $\text{NaN}_3$ , 10 mM GSH, 1.5 mM NADPH, 36 mU of glutathione reductase, and 5 mM  $\text{H}_2\text{O}_2$ . The optical density changes at 340 nm were monitored at room temperature.

#### Data analysis

The data are expressed as the mean  $\pm$  standard error. One-way Analysis of variance with least significant difference *post-hoc* test was used to evaluate differences between groups  $P < 0.05$  were regarded as statistically significant.

## RESULTS

#### Contents of total phenolic compounds and flavonoids contained in valerianae radix et rhizoma water extract

Folin–ciocalteu method for total phenolic compounds clears that VRe contain small amount of phenolic compound, that is, 0.3%, and diethylene glycol colorimetric method shows 0.1% amount of flavonoids in VRe [Table 1].

#### Effects of valerianae radix et rhizoma water extract treatment in the plasma corticosterone

Stress exposure increases plasma corticosterone level and VRe administration significantly reduced plasma corticosterone level in psychologically stressed mice [Figure 4].<sup>[28]</sup> FS stressed mice had higher plasma corticosterone concentration than psychologically

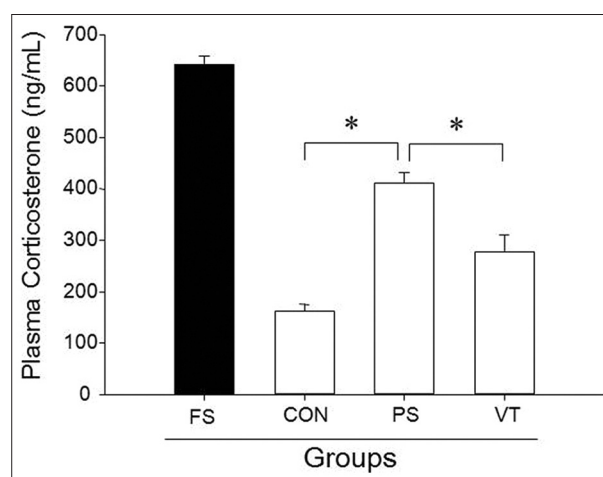

**Figure 4:** Effect of Valerianae Radix et Rhizoma extract (VRe) on corticosterone level of imprinting control region-mice for 5 days. Normal, normal group. Foot shock stress group. Control group, normal group; psychological stress group (PS); VRe treatment, PS group, and were administered VRe containing 100 mg/kg/day. \*significantly different when compared ( $P < 0.05$ )

stressed ones. Numerical figures are  $642 \pm 17$  ng/ml,  $162 \pm 14$  ng/ml,  $411 \pm 21$  ng/ml and  $279 \pm 31$  ng/ml for FS, CON, PS, and VT, respectively.

#### Effects on serum level of alanine aminotransferase

Alanine aminotransferase is found primarily in the liver and kidneys, with small amounts in heart and skeletal muscles, and is considered as one of the most useful and sensitive indicators of liver damage.<sup>[29,30]</sup> VRe administration showed no significant reduction of ALT level [Figure 5]. Physical stress had a positive effect on ALT level. Values are  $43.1 \pm 2.4$  Karmen/ml,  $12.7 \pm 1.8$  Karmen/ml,  $32.1 \pm 4.7$  Karmen/ml and  $22.7 \pm 3.4$  Karmen/ml for FS, CON, PS, and VT, respectively.

#### Effects on noradrenaline level of brain tissues

Noradrenaline is a neurotransmitter that affects the part of the central nervous system, such as amygdala,<sup>[31]</sup> and it is known that noradrenaline level in the dorsal cortex of brain decrease with increasing magnitude of stress.<sup>[32]</sup> VRe administration showed a significant increase in noradrenaline level [Figure 6]. Physically stressed mice had low noradrenaline level. Values are  $72.3 \pm 8.7$   $\mu$ g/g brain,  $182.6 \pm 8.4$   $\mu$ g/g brain,  $141.2 \pm 14.6$   $\mu$ g/g brain and  $167.1 \pm 11.7$   $\mu$ g/g brain for FS, CON, PS, and VT, respectively.

#### Effects on serum lipid peroxidation

As one of highly reactive species, free radicals have been implicated in the pathogenesis of many diseases, and can initiate lipid peroxidation leading to cell death, and MDA is formed as an end product of lipid peroxidation.<sup>[33-36]</sup> VRe administration showed no significant changes in lipid peroxidation [Figure 7]. Values are  $4.1 \pm 0.5$ ,  $3.4 \pm 0.7$ ,

$3.7 \pm 0.4$ , and  $3.5 \pm 0.4$  pmole/mg protein for FS, CON, PS, and VT, respectively.

#### Effects of valerianae radix et rhizoma water extract on serum level of antioxidant enzyme activities

The effect of VRe might result from a direct interaction with reactive oxygen species (ROS) or an indirect action on innate antioxidant enzymes. To elucidate the mechanism, the effects of VRe on serum activities of antioxidant enzymes were determined. As summarized in Table 2, VRe did not affect the activities of superoxide dismutase, catalase, and glutathione peroxidase. This result suggests that VRe might exert its effect by acting itself as a direct scavenger of ROS.

**Table 1: Total phenolic compounds and flavonoids contents in VRe**

	Contents in 10 mg/ml VRe solution ( $\mu$ g)	Percentage of contents in VRe
Total phenolic compounds	31.1	0.3
Total flavonoids	10.0	0.1

VRe: Valerianae Radix et Rhizoma water extract

**Table 2: Effects of VRe (1 mg/ml) on activities of the antioxidant enzymes in the serum of mice**

	Cu-Zn SOD (U/g protein)	Catalase (k/g protein)	Reduced glutathione (mg/g protein)
FS	15743 $\pm$ 2417	20.7 $\pm$ 3.5	0.7 $\pm$ 0.2
Normal	11247 $\pm$ 728	6.2 $\pm$ 0.4	1.7 $\pm$ 0.3
Control	13542 $\pm$ 2717	17.6 $\pm$ 2.4*	0.8 $\pm$ 0.2*
VRe	12795 $\pm$ 1305	15.3 $\pm$ 3.4	0.9 $\pm$ 0.2

Mean $\pm$ SE of 5 determinations. \*Statistically significant when compared with control ( $P < 0.05$ ). VRe: Valerianae Radix et Rhizoma water extract; SE: Standard of error; FS: Foot-shocked

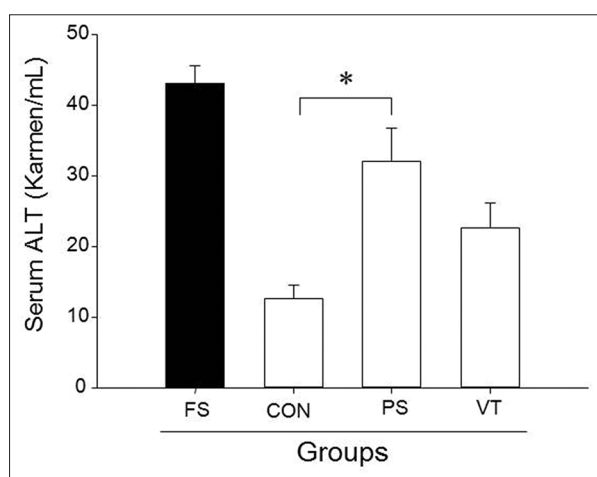

**Figure 5:** Effect of Valerianae Radix et Rhizoma water extract (VRe) on serum alanine aminotransferase level of imprinting control region-mice for 5 days. Foot shock stress group. Control group, normal group; psychological stress group (PS); VRe treatment, PS group, and were administered VRe containing 100 mg/kg/day. \*significantly different when compared ( $P < 0.05$ )

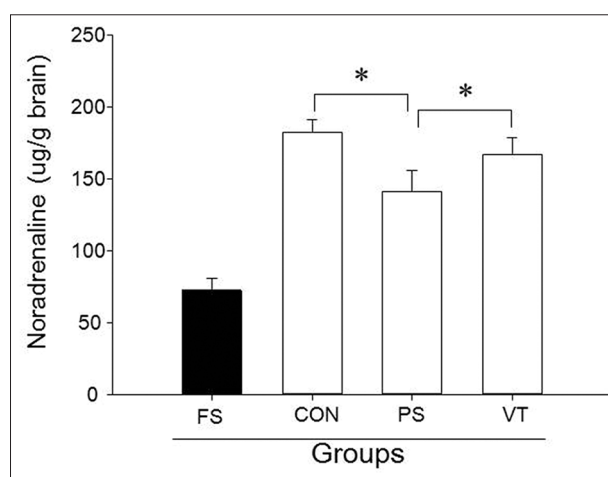

**Figure 6:** Effect of Valerianae Radix et Rhizoma water extract (VRe) on noradrenaline level in brain dorsal cortex area of imprinting control region-mice for 5 days. Foot shock stress group. Control group, normal group; psychological stress group (PS); VRe treatment, PS group, and were administered VRe containing 100 mg/kg/day. \*significantly different when compared ( $P < 0.05$ )

### Effects of valerianae radix et rhizoma water extract treatment in the elevated plus-maze

Valerianae Radix et Rhizoma water extract administration showed an anxiolytic-like effect at 100 mg/kg. Vehicle treated CON avoided spending time in open arms, whereas VRe dosed group spent significantly more prolonged time in open arms [Figure 8]. Although the group treated with VRe entered the open arm more frequently, no statistically significant changes were observed [Figure 9].

## DISCUSSION

The primary properties of Valerian (a common name of *V. fauriei*) are anodyne, antispasmodic, antibacterial, astringent, anxiolytic, carminative, hypnotic, muscle relaxant, nervine, and most importantly, sedative.<sup>[37-42]</sup> It is known that its constituents include valepotriates, alkaloids (*chatinine, valerine*), valeric acid, essential oils (*acetic acid, borneol, pinene, camphene*), caffeic acid, beta-sitosterol, tannin, manganese, calcium, choline, and B vitamins.<sup>[43-45]</sup>

Most of current usage of Valerian work by disrupting natural sleep rhythms—it excites the cerebro-spinal system. But in case of high dosage, it may cause headache, giddiness, restlessness, mental excitement, visual illusions, agitation, spasmodic movements, and frequently nausea.<sup>[38,43,45]</sup> In medicinal doses, it can act as a stimulant tonic, calmative and antispasmodic, and has been prescribed for chorea and hysteria, and in selected cases it relieves pain and irritability and favors rest and sleep.<sup>[38,41,45]</sup> For such reasons, it is useful for hemicranias and nervous headache.

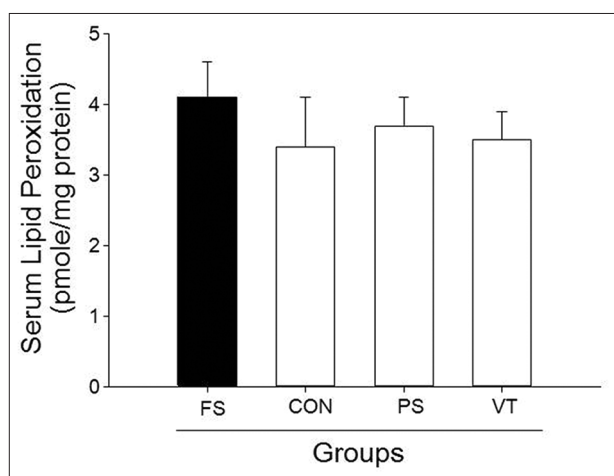

**Figure 7:** Effect of Valerianae Radix et Rhizoma water extract (VRe) on lipid peroxidation in the serum of imprinting control region-mice for 5 days. Foot shock stress group. Control group, normal group; psychological stress group (PS); VRe treatment, PS group, and were administered VRe containing 100 mg/kg/day

Effect of VRe on circadian rhythm is observed in corticosterone level in blood plasma, and VRe administration significantly reduced corticosterone level in the tested mice [Figure 4]. High figures of corticosterone could be induced during the dark for nocturnal animals, and stress exposure increases plasma corticosterone level and also disrupts the observed circadian rhythm.<sup>[28]</sup> VRe administration did not show any significant decrease on serum ALT level [Figure 5].

Noradrenaline affects part of the central nervous system and increasing magnitude of stress decrease with noradrenaline level in the dorsal cortex of the brain.<sup>[31,32]</sup> In this study, noradrenaline levels in mice were measured in discrete brain regions after the stress exposure, and VRe administration showed a significant decrease in the noradrenaline level [Figure 6].

Lipid peroxidation occurs by free radical mechanism, which can also involve macromolecules such as DNA and proteins,<sup>[33,34]</sup> and free radicals can lead to pathogenesis of organs.<sup>[35,36]</sup> It was observed that VRe showed no significant changes in lipid peroxidation in the serum and brain [Figure 7]. To elucidate the effect of VRe against ROS generation, serum levels of antioxidant enzymes were determined. Psychological stress elevated serum level of catalase, and glutathione peroxidase, but VRe did not affect the serum activities of antioxidant enzymes [Table 2].

The EPM test is used to measure the effectiveness of anxiolytic drugs on mice.<sup>[46]</sup> Inexperienced mice will normally prefer to spend more time in closed arms and

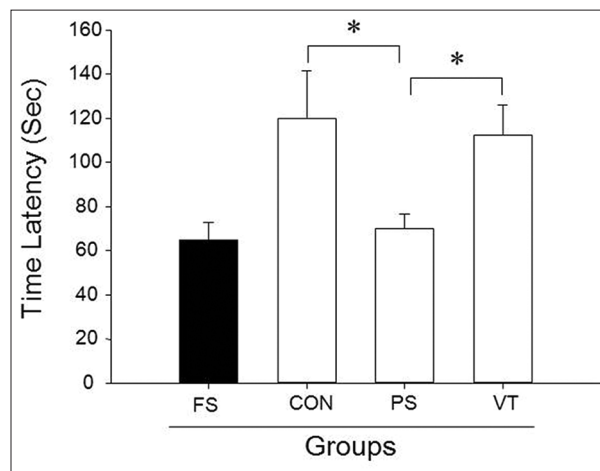

**Figure 8:** Effects of Valerianae Radix et Rhizoma water extract (VRe) on the psychological stress (PS) on the time spent in open arms of the elevated plus-maze test in mouse. Values represent mean  $\pm$  standard error of eight mice per group. Foot shock stress group. Control group, normal group; PS group; VRe treatment, PS group, and were administered VRe containing 100 mg/kg/day. \*significantly different when compared ( $P < 0.05$ )

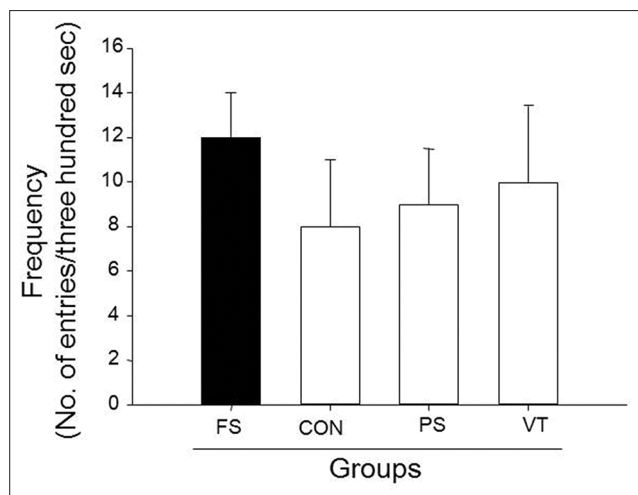

**Figure 9:** Effects of Valerianae Radix et Rhizoma water extract (VRe) on the psychological stress (PS) on the number of arm entries into the closed arms of the elevated plus-maze test in mouse. Values represent mean  $\pm$  standard error of eight mice per group. Foot shock stress group. Control group, normal group; psychological stress group (PS); VRe treatment, PS group, and were administered VRe containing 100 mg/kg/day

less time in open arms. The frequency of excursions from closed arms and the relative time spent in open arms (Transfer latency [TL]) can be used as a degree of anxiety in mice. VRe administration showed a significant increase in TL, but no significant effect was observed for the transfer frequency [Figures 8 and 9].

## CONCLUSIONS

The present study suggests that exposure to PS results in physiological and behavioral changes in animals. An herbal plant, *V. fauriei*, which has been used as a natural anxiolytic drug, was used as a candidate to reduce PS in mice. It was determined that the water extract of *V. fauriei* shows positive effects in some mice stress indicators such as plasma corticosterone, noradrenaline, and EPM TL.

## ACKNOWLEDGMENT

The assistance of Joon Hwa Choi in some of the experiments is gratefully acknowledged.

## REFERENCES

- Schwabe L, Joëls M, Roozendaal B, Wolf OT, Oitzl MS. Stress effects on memory: An update and integration. *Neurosci Biobehav Rev* 2012;36:1740-9.
- Allen AP, Kennedy PJ, Cryan JF, Dinan TG, Clarke G. Biological and psychological markers of stress in humans: Focus on the Trier Social Stress Test. *Neurosci Biobehav Rev* 2014;38:94-124.
- O'Donovan A, Neylan TC, Metzler T, Cohen BE. Lifetime exposure to traumatic psychological stress is associated with elevated inflammation in the heart and soul study. *Brain Behav Immun* 2012;26:642-9.
- Liu XG, Gao PY, Wang GS, Song SJ, Li LZ, Li X, et al. *In vivo* antidepressant activity of sesquiterpenes from the roots of *Valeriana fauriei* Briq. *Fitoterapia* 2012;83:599-603.
- Kang BS, Kang SS, Kang SK, Kang CK, Ko WC, Ko HG, et al. Dictionary of traditional Chinese medicines. *Jungdam Publ Korea* 1985;10:5171-4.
- Sudati JH, Vieira FA, Pavin SS, Dias GR, Seeger RL, Golombieski R, et al. *Valeriana officinalis* attenuates the rotenone-induced toxicity in *Drosophila melanogaster*. *Neurotoxicology* 2013;37:118-26.
- Abourashed EA, Koetter U, Brattström A. *In vitro* binding experiments with a *Valerian*, hops and their fixed combination extract (Ze91019) to selected central nervous system receptors. *Phytomedicine* 2004;11:633-8.
- Gutierrez S, Ang-Lee MK, Walker DJ, Zacny JP. Assessing subjective and psychomotor effects of the herbal medication valerian in healthy volunteers. *Pharmacol Biochem Behav* 2004;78:57-64.
- Fernández S, Wasowski C, Paladini AC, Marder M. Sedative and sleep-enhancing properties of linarin, a flavonoid-isolated from *Valeriana officinalis*. *Pharmacol Biochem Behav* 2004;77:399-404.
- Asnis GM, Nathan RS, Halbreich U, Halpern FS, Sachar EJ. TRH tests in depression. *Lancet* 1980;1:424-5.
- Lustberg L, Reynolds CF. Depression and insomnia: Questions of cause and effect. *Sleep Med Rev* 2000;4:253-62.
- Bauman RA, Kant GJ. Circadian effects of escapable and inescapable shock on the food intake and wheelrunning of rats. *Physiol Behav* 1992;51:167-74.
- Kant GJ, Pastel RH, Bauman RA, Meininger GR, Maughan KR, Robinson TN 3<sup>rd</sup>, et al. Effects of chronic stress on sleep in rats. *Physiol Behav* 1995;57:359-65.
- Anderson SM, Kant GJ, De Souza EB. Effects of chronic stress on anterior pituitary and brain corticotropin-releasing factor receptors. *Pharmacol Biochem Behav* 1993;44:755-61.
- Martí O, Gavalda A, Jolin T, Armario A. Effect of regularity of exposure to chronic immobilization stress on the circadian pattern of pituitary adrenal hormones, growth hormone, and thyroid stimulating hormone in the adult male rat. *Psychoneuroendocrinology* 1993;18:67-77.
- Tornatzky W, Miczek KA. Long-term impairment of autonomic circadian rhythms after brief intermittent social stress. *Physiol Behav* 1993;53:983-93.
- Restrepo C, Armario A. Chronic stress alters pituitary-adrenal function in prepubertal male rats. *Psychoneuroendocrinology* 1987;12:393-8.
- Ottenweller JE, Natelson BH, Pitman DL, Drastal SD. Adrenocortical and behavioral responses to repeated stressors: Toward an animal model of chronic stress and stress-related mental illness. *Biol Psychiatry* 1989;26:829-41.
- Takaoka N, Hara C, Ogawa N. Characteristics of coping behavior of rats exposed to a long-term hardly escapable aversive stimulus: A possible depression model. *Jpn J Pharmacol* 1988;47:159-68.
- Lister RG. Interactions of three benzodiazepine receptor inverse agonists with ethanol in a plus-maze test of anxiety. *Pharmacol Biochem Behav* 1988;30:701-6.
- Mefford IN. Application of high performance liquid chromatography with electrochemical detection to neurochemical analysis: Measurement of catecholamines, serotonin and metabolites in rat brain. *J Neurosci Methods* 1981;3:207-24.

22. Mefford IN, Gilberg M, Barchas JD. Simultaneous determination of catecholamines and unconjugated 3,4-dihydroxyphenylacetic acid in brain tissue by ion-pairing reverse-phase high-performance liquid chromatography with electrochemical detection. *Anal Biochem* 1980;104:469-72.
23. Mihara M, Uchiyama M. Determination of malonaldehyde precursor in tissues by thiobarbituric acid test. *Anal Biochem* 1978;86:271-8.
24. Bradford MM. A rapid and sensitive method for the quantitation of microgram quantities of protein utilizing the principle of protein-dye binding. *Anal Biochem* 1976;72:248-54.
25. Aebi H. Catalase *in vitro*. *Methods Enzymol* 1984;105:121-6.
26. McCord JM, Fridovich I. Superoxide dismutase. An enzymic function for erythrocyte protein (hemocuprein). *J Biol Chem* 1969;244:6049-55.
27. Lawrence RA, Burk RF. Glutathione peroxidase activity in selenium-deficient rat liver 1976. *Biochem Biophys Res Commun* 2012;425:503-9.
28. Bonilla-Jaime H, Retana-Márquez S, Arteaga-Silva M, Hernández-González M, Vázquez-Palacios G. Circadian activity of corticosterone in an animal model of depression: Response to muscarinic cholinergic stimulation. *Physiol Behav* 2010;100:311-5.
29. Jung K, Mildner D, Jacob B, Scholz D, Precht K. On the pyridoxal-5'-phosphate stimulation of aspartate aminotransferase and alanine aminotransferase in serum and erythrocytes of patients undergoing chronic haemodialysis and with kidney transplants. *Clin Chim Acta* 1981;115:105-10.
30. Wroblewski F. The clinical significance of alterations in transaminase activities of serum and other body fluids. *Adv Clin Chem* 1958;1:313-51.
31. Tanaka M, Yoshida M, Emoto H, Ishii H. Noradrenaline systems in the hypothalamus, amygdala and locus coeruleus are involved in the provocation of anxiety: Basic studies. *Eur J Pharmacol* 2000;405:397-406.
32. Konstandi M, Johnson E, Lang MA, Malamas M, Marselos M. Noradrenaline, dopamine, serotonin: Different effects of psychological stress on brain biogenic amines in mice and rats. *Pharmacol Res* 2000;41:341-6.
33. Gutteridge JM. Lipid peroxidation and antioxidants as biomarkers of tissue damage. *Clin Chem* 1995;41:1819-28.
34. Halliwell B, Gutteridge JM. Lipid peroxidation in brain homogenates: The role of iron and hydroxyl radicals. *J Neurochem* 1997;69:1330-1.
35. Kehrer JP. Free radicals as mediators of tissue injury and disease. *Crit Rev Toxicol* 1993;23:21-48.
36. Kehrer JP, Smith CV. 2-free radicals in biology: Sources, reactivities, and roles in the etiology of human diseases. In: Frei B, editor. *Natural Antioxidants in Human Health and Disease*. San Diego: Academic Press; 1994. p. 25-62.
37. Al-Majed AA, Al-Yahya AA, Al-Bekairi AM, Al-Shabanah OA, Qureshi S. Studies on the cytological and biochemical effects of valerian in somatic and germ cells of Swiss albino mice. *Food Chem Toxicol* 2006;44:1830-7.
38. Cass H. Herbs for the nervous system: Ginkgo, kava, valerian, passionflower. *Semin Integr Med* 2004;2:82-8.
39. Chen JH, Chao YH, Lu SF, Shiung TF, Chao YF. The effectiveness of valerian acupressure on the sleep of ICU patients: A randomized clinical trial. *Int J Nurs Stud* 2012;49:913-20.
40. Francis AJ, Dempster RJ. Effect of valerian, *Valeriana edulis*, on sleep difficulties in children with intellectual deficits: Randomised trial. *Phytomedicine* 2002;9:273-9.
41. Houghton PJ. The biological activity of *Valerian* and related plants. *J Ethnopharmacol* 1988;22:121-42.
42. Mirabi P, Dolatian M, Mojab F, Majd HA. Effects of valerian on the severity and systemic manifestations of dysmenorrhea. *Int J Gynaecol Obstet* 2011;115:285-8.
43. Bos R, Hendriks H, Scheffer JJ, Woerdenbag HJ. Cytotoxic potential of valerian constituents and valerian tinctures. *Phytomedicine* 1998;5:219-25.
44. Felgentreff F, Becker A, Meier B, Brattström A. *Valerian* extract characterized by high valerenic acid and low acetoxyl valerenic acid contents demonstrates anxiolytic activity. *Phytomedicine* 2012;19:1216-22.
45. Jamison JR. Clinical guide to nutrition and dietary supplements in disease management. In: Jamison JR, editor. *Clinical Guide to Nutrition and Dietary Supplements in Disease Management*. Saint Louis: Churchill Livingstone; 2003. p. 673-5.
46. Hogg S. A review of the validity and variability of the elevated plus-maze as an animal model of anxiety. *Pharmacol Biochem Behav* 1996;54:21-30.

**Cite this article as:** Kim JS, Ahn JD, Cho SI. Effects of Valerianae Radix et Rhizoma extract on psychological stress in mice. *Phcog Mag* 2015;11:381-8.

**Source of Support:** Nil, **Conflict of Interest:** None declared.