

Review

G-protein signaling: back to the future

C. R. McCudden, M. D. Hains, R. J. Kimple, D. P. Siderovski* and F. S. Willard

Department of Pharmacology, Lineberger Comprehensive Cancer Center, and UNC Neuroscience Center, The University of North Carolina at Chapel Hill, 1106 Mary Ellen Jones Building, Chapel Hill, North Carolina 27599-7365 (USA), Fax: +1 919 966 5640, e-mail: dsiderov@med.unc.edu

Received 21 October 2004; received after revision 20 November 2004; accepted 30 November 2004

Abstract. Heterotrimeric G-proteins are intracellular partners of G-protein-coupled receptors (GPCRs). GPCRs act on inactive $G\alpha$ -GDP/ $G\beta\gamma$ heterotrimers to promote GDP release and GTP binding, resulting in liberation of $G\alpha$ from $G\beta\gamma$. $G\alpha$ -GTP and $G\beta\gamma$ target effectors including adenylyl cyclases, phospholipases and ion channels. Signaling is terminated by intrinsic GTPase activity of $G\alpha$ and heterotrimer reformation – a cycle accelerated by ‘regulators of G-protein signaling’ (RGS proteins). Recent studies have identified several unconventional G-protein signaling pathways that diverge from this

standard model. Whereas phospholipase C (PLC) β is activated by $G\alpha_q$ and $G\beta\gamma$, novel PLC isoforms are regulated by both heterotrimeric and Ras-superfamily G-proteins. An *Arabidopsis* protein has been discovered containing both GPCR and RGS domains within the same protein. Most surprisingly, a receptor-independent $G\alpha$ nucleotide cycle that regulates cell division has been delineated in both *Caenorhabditis elegans* and *Drosophila melanogaster*. Here, we revisit classical heterotrimeric G-protein signaling and explore these new, non-canonical G-protein signaling pathways.

Key words. Asymmetric cell division; GoLoco motif; G-protein; phospholipase C; RGS proteins.

The standard model of heterotrimeric G-protein signaling

Cellular signaling is accomplished by a myriad of proteins, peptides, lipids, ions and small molecules. Signals are commonly transmitted by the actions of hormones released from the same cell (autocrine), a neighboring cell (paracrine) or distant cells (endocrine). For example, neurotransmitter release at the synaptic cleft can propagate signals to neurons, muscle cells and neuroendocrine cells, and can also participate in autocrine feedback signals to the neuron releasing the neurotransmitter. Kinases, phosphatases, proteases and nucleotide binding proteins all contribute to the intracellular propagation of signaling. Many of these proteins alternate between an ‘on’ and an ‘off’ state to regulate the duration and inten-

sity of the signal. Guanine nucleotide binding proteins or ‘G-proteins’ are among the most ubiquitous of these cellular switches and alternate between a GDP-bound off state and a GTP-bound on state.

The standard model of G-protein-coupled receptor (GPCR) signaling is outlined in figure 1. Heterotrimeric G-proteins are the intracellular partners of seven transmembrane-domain (7TM) GPCRs. Membrane-bound heterotrimers composed of $G\alpha$, $G\beta$ and $G\gamma$ subunits are closely associated with the intracellular faces of GPCRs. GDP-bound $G\alpha$ subunits bind tightly to the obligate heterodimer of $G\beta\gamma$. This association aids $G\alpha$ localization to the plasma membrane (e.g. [1]; reviewed in [2]) and is essential for functional coupling to GPCRs [3]. In addition, $G\beta\gamma$ binding to GDP-bound $G\alpha$ slows the spontaneous rate of GDP release, thus acting as a guanine-nucleotide dissociation inhibitor (GDI) [4, 5]. Agonist-bound GPCRs act as guanine nucleotide exchange factors (GEFs), promoting the release of bound GDP by $G\alpha$.

* Corresponding author.

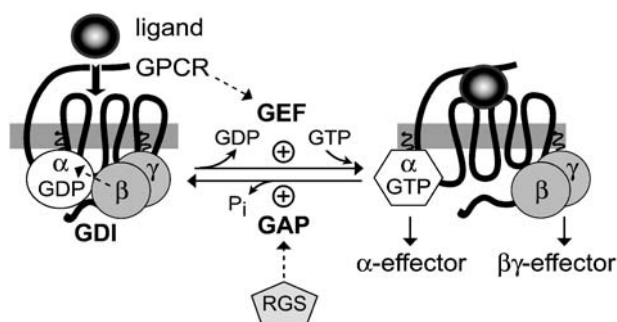

Figure 1. Standard model of the GDP/GTP cycle governing activation of heterotrimeric GPCR signaling pathways. In the absence of ligand, the $G\alpha$ subunit is GDP bound and closely associated with the $G\beta\gamma$ heterodimer. This $G\alpha$ -GDP/ $G\beta\gamma$ heterotrimer interacts with the cytosolic loops of a seven-transmembrane-domain G-protein-coupled receptor (GPCR). $G\beta\gamma$ facilitates the coupling of $G\alpha$ to receptor and also acts as a guanine nucleotide dissociation inhibitor (GDI) for $G\alpha$ -GDP, slowing the spontaneous exchange of GDP for GTP. Ligand-bound GPCRs act as guanine nucleotide exchange factors (GEFs) by inducing a conformational change in the $G\alpha$ subunit, allowing it to exchange GTP for GDP. $G\beta\gamma$ dissociates from $G\alpha$ -GTP, and both $G\alpha$ -GTP and $G\beta\gamma$ are competent to signal to their respective effectors. The cycle returns to the basal state when $G\alpha$ hydrolyzes the gamma-phosphate moiety of GTP, a reaction that is augmented by GTPase-accelerating proteins (GAPs) such as the Regulator of G-protein Signaling (RGS) proteins.

Nucleotide-free $G\alpha$ then binds GTP, which is present at a significant molar excess over GDP in cells. The binding of GTP results in conformational changes within the three flexible switch regions of $G\alpha$ [6], resulting in the dissociation of $G\beta\gamma$. Both GTP-bound $G\alpha$ and free $G\beta\gamma$ are capable of initiating signals by interacting with downstream effector proteins. The intrinsic guanosine triphosphatase (GTPase) activity of the $G\alpha$ subunit causes the hydrolysis of GTP to GDP, returning the $G\alpha$ subunit to its inactive state. Reassociation of $G\beta\gamma$ with $G\alpha$ -GDP terminates all effector interactions [7, 8]. Thus, the standard model of GPCR signaling assumes that the $G\alpha$ subunit's lifetime in the GTP-bound state controls the duration of signaling of both $G\alpha$ -GTP and free $G\beta\gamma$ subunits.

G-protein subunits

The $G\alpha$ subunit

There are 16 $G\alpha$ genes in the human genome which encode 23 known $G\alpha$ proteins. These proteins can be divided into four major classes based on sequence similarity: $G\alpha_{(s/olf)}$, $G\alpha_{(i1/i2/i3/o/t-rod/t-cone/gust/z)}$, $G\alpha_{(q/11/14/16)}$ and $G\alpha_{(12/13)}$ [9]. $G\alpha$ subunits range in size from 39 to 45 kilodaltons (kDa) [10], and are N-terminally modified by the covalent attachment of the fatty acids myristate and/or palmitate. N-myristoylation of $G\alpha_i$ family members is the result of co-translational addition of the saturated 14-carbon fatty acid to the glycine at the new N-terminus of the protein

following removal of the initiator methionine [11]. All $G\alpha$ subunits except the photoreception-specific $G\alpha$ ('transducin' or $G\alpha_t$) contain a 16-carbon palmitate reversibly attached through a thioester bond to a cysteine near the N-terminus [11]. Lipid modification of $G\alpha$ subunits is important for membrane localization. Palmitoylation results in the stable attachment of $G\alpha$ subunits to the membrane [12]. Myristoylation contributes to membrane localization, although expression of myristoylated but not palmitoylated $G\alpha_{i/o}$ results in the localization of a substantial portion of the $G\alpha$ subunits to the cytosolic fraction [13–15]. Myristoylation and/or palmitoylation of $G\alpha$ subunits affects targeting to specific cell membrane regions and regulates interactions with other proteins such as adenylyl cyclase, $G\beta\gamma$, and GPCRs [16–19].

The $G\beta\gamma$ dimer

There are 5 known human $G\beta$ [20, 21] and 12 human $G\gamma$ subunit genes [9, 22, 23], resulting in a large number of potential combinations of $G\beta\gamma$ dimers. All $G\gamma$ subunits are C-terminally prenylated post-synthetically: $G\gamma_1$, $G\gamma_8$ and $G\gamma_{11}$ with a 15-carbon farnesyl moiety, and the rest with a 20-carbon geranylgeranyl group [11]. This lipid modification of the $G\gamma$ polypeptide is important for the resultant membrane localization of the $G\beta\gamma$ dimer. Most $G\beta\gamma$ combinations can form functional heterodimers [24]; however, there are exceptions; e.g. $G\beta_2$ can pair with $G\gamma_2$ but not $G\gamma_1$ [25].

Evidence supporting the role of specific $G\beta\gamma$ combinations in receptor coupling and effector activation is sparse but growing [24]. Most in vitro assays show little difference in receptor coupling profile or effector activation. However, there are some in vivo examples of the importance of specific $G\beta\gamma$ pairs for specific signaling pathways. $G\beta_1\gamma_1$ interacts more robustly with rhodopsin and phosphodiesterase than other $G\beta\gamma$ combinations [26]. Inhibition of α_1H low-voltage-activated T-type ($Ca_v3.2$) calcium channels is mediated selectively by $G\beta_2\gamma_2$ [27]. $G\gamma_3$ was shown to be important for coupling the somatostatin receptor to voltage-sensitive L-type calcium channels, while $G\gamma_4$ was found to be required for coupling the muscarinic receptor to the same channels [28].

Recent studies by Robishaw and co-workers have defined specific roles for $G\gamma_7$ in coupling heterotrimeric G-proteins to receptors [29–32]. Endogenous $G\gamma_7$ expression was suppressed in HEK-293 cells using a ribozyme approach, resulting in a coincident decrease in expression of $G\beta_1$ but not $G\beta_2$ through $G\beta_3$ subunits. PGE₁, muscarinic and purinergic GPCR signals were unaffected by $G\gamma_7$ knockdown; however, isoproterenol-induced adenylyl cyclase activity was abrogated suggesting a specific role for $G\gamma_7$ in β -adrenergic receptor signaling. $G\gamma_7$ -knockout mice are fertile and of normal weight, but exhibit an

increased startle response. Notable are the striking changes in the striatum, with $G\alpha_{olf}$ expression reduced 82%, whereas $G\alpha_o$, $G\alpha_q$, $G\alpha_s$ and $G\alpha_{13}$ are expressed at normal levels. $G\gamma_7$ -null mice also show reduced levels of D1 dopamine receptor-induced adenylyl cyclase activity in the striatum, complementing the reduced D1 receptor function found previously in $G\gamma_7$ -knockdown cells.

G-protein structure

The $G\alpha$ subunit

The $G\alpha$ subunit (fig. 2A) is composed of two domains: a nucleotide binding domain with high structural homology to Ras-superfamily GTPases, and an all-alpha-helical domain that, in combination with the Ras-like domain, helps to form a deep pocket for binding guanine nucleotide (fig. 2B; reviewed in [33]). $G\alpha$ subunits contain three flexible regions designated switch-I, -II and -III that change conformation in response to GTP binding and hydrolysis [34–38]. The GTP-bound conformation of $G\alpha$, which can be mimicked by the nonhydrolyzable GTP analogue, GTP γ S, results in decreased affinity for $G\beta\gamma$ subunit dissociation and increased affinity for $G\alpha$ effectors. The planar ion aluminum tetrafluoride (AlF_4^-) mimics the conformation of the terminal γ -phosphate of GTP during the transition state of GTP hydrolysis [39], and is useful for studying the *in vitro* interactions of $G\alpha$ subunits with various regulators and effectors [40, 41]. Structural studies of $G\alpha$ -GDP- AlF_4^- alone [34, 38] and in combination with RGS4 [37] have provided a better understanding of how nucleotide hydrolysis occurs. Indeed, mutations to a critical arginine (e.g. R178 in $G\alpha_{i1}$; fig. 2B) or glutamine (e.g. Q204 in $G\alpha_{i1}$), each involved in stabilizing the γ -phosphate leaving group during hydrolysis [34, 38], are commonly used to make $G\alpha$ subunits GTPase-deficient and thus constitutively active (e.g. [42]). The Ras-like domain, a variation on the nucleotide-binding fold [43], adopts a conformation also seen in EF-Tu, Ras and Rap1A [44–46]. The helical domain, an insertion between the α_1 helix and β_2 strand of the core Ras-like domain, folds into a six-alpha-helix bundle (fig. 2A). Interactions of residues which span the domain interface are thought to be involved in receptor-mediated nucleotide exchange and subsequent G-protein dissociation [47]. $G\alpha$ subunits also contain an extended N-terminal region of 26–36 residues. The first 23 residues are disordered in the structure of $G\alpha$ in both the GDP and the GTP γ S bound state [35, 48]. Structures of the heterotrimer show that this region forms an α -helix that interacts with $G\beta$ [36, 49]. Recent evidence from Hamm and colleagues suggests that the N-terminal myristate of the $G\alpha$ subunit imparts conformational rigidity to the amino terminus of the $G\alpha$ subunit and implies that the N-terminus of $G\alpha$ may be highly ordered *in vivo* [50].

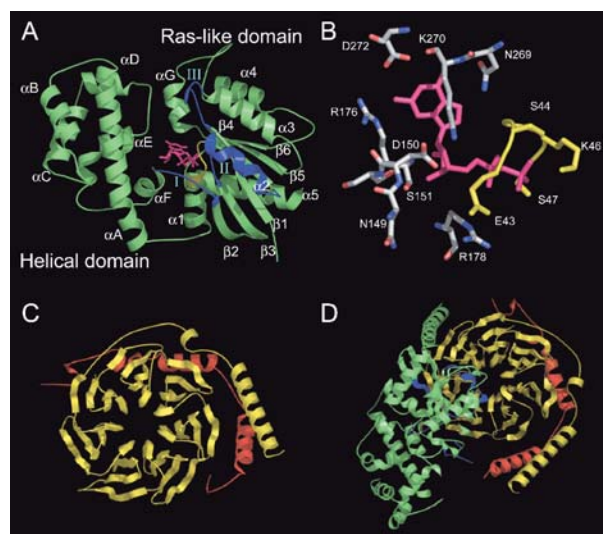

Figure 2. Structural features of heterotrimeric G-protein subunits. (A) The crystal structure of $G\alpha$:GDP· AlF_4^- (Protein Data Bank identifier: 1TAD) illustrates the Ras-like domain, the all-alpha-helical domain and the bound nucleotide at the interdomain interface. Switch regions I, II and III are shown in blue, GDP in magenta and the phosphate binding loop (P-loop) in yellow. Alpha-helices and beta-sheets are labeled according to traditional designations. (B) Close-up view of the guanine nucleotide binding pocket of a chimeric $G\alpha_{i1}$ subunit (structural coordinates from PDB ID: 1GOT). Residues that contact the guanine base, ribose sugar, and α and β phosphates are labeled. P-loop residues are shown in yellow and GDP in magenta. (C) The structure of the $G\beta_1\gamma_1$ dimer (PDB ID: 1TBG) shows that $G\beta$ (yellow) forms a seven-bladed propeller consisting of seven WD40 repeats. $G\gamma$ (red) forms two alpha helices that bind to the single alpha-helix of $G\beta$ and to several of the WD40 blades. (D) The crystal structure of the heterotrimer (PDB ID: 1GOT) shows that the switch regions of $G\alpha$ (blue) form part of the interface for interaction with $G\beta\gamma$.

The $G\beta\gamma$ dimer

The $G\beta\gamma$ subunit is a functional heterodimer (fig. 2C, D) that forms a stable structural unit. All $G\beta$ subunits contain seven WD-40 repeats, a tryptophan-aspartic acid sequence that repeats about every 40 amino acids and forms small antiparallel β strands [51]. Crystal structures of the $G\beta\gamma$ dimer (fig. 2C) and $G\alpha\beta\gamma$ trimer (fig. 2D) revealed that the seven WD-40 repeats of the $G\beta$ subunit folds into a seven-bladed β -propeller or torus-like structure, while the N-terminus forms an α -helix [36, 49, 52]. $G\gamma$ folds into two α -helices; the N-terminal helix forms a coiled-coil with the α -helix of $G\beta$, while the C-terminal helix makes extensive contacts with the base of the $G\beta$ torus [36, 49, 52]. Unlike the conformationally flexible $G\alpha$ subunit, the $G\beta\gamma$ dimer does not change conformation when it dissociates from the G-protein heterotrimer [52]. In addition, $G\beta\gamma$ association with $G\alpha$ prevents $G\beta\gamma$ from activating its effectors. These two findings suggest that the binding sites on $G\beta\gamma$ for $G\alpha$ and $G\beta\gamma$ effectors are at least partially shared. In support of this hypothesis,

mutation of several residues on $G\beta$ that contact $G\alpha$ can abrogate $G\beta\gamma$ -mediated phospholipase C- β_2 and adenylyl cyclase activation [7, 8]. Several groups have identified other regions of $G\beta$ that are important for effector activation, indicating that the $G\alpha$ binding site on $G\beta\gamma$ is not the only effector contact region [53, 54].

G-protein signaling pathways

$G\alpha$ effectors

All four classes of $G\alpha$ subunits now have well-established cellular targets. The first recognized $G\alpha$ effector was adenylyl cyclase (AC), first described by Sutherland and Rall [55, 56]. Nearly 20 years after the identification of AC as an important component of intracellular signaling, a GTP binding protein that stimulated AC was isolated; it has since been termed $G\alpha_s$ [57]. Shortly thereafter, $G\alpha_i$, which inhibits AC and thus opposes the action of $G\alpha_s$, was identified [58–61]. In recent years, it has become clear that the membrane-bound ACs exhibit a diverse expression pattern and respond positively or negatively to distinct sets of regulatory inputs including $G\beta\gamma$ and divalent cations [62, 63].

$G\alpha$ protein signaling is also critically involved in sensory transduction. GPCRs can act as tastant and odorant receptors, coupling internally to G-proteins such as $G\alpha_{\text{gust}}$ and $G\alpha_{\text{olf}}$ respectively [64, 65]. Similarly, vision is dependent on GPCR-mediated phototransduction, a unique signaling cascade that utilizes $G\alpha_t$ to regulate a cyclic GMP-gated $\text{Na}^+/\text{Ca}^{2+}$ channel through its effector cGMP phosphodiesterase [66].

G-protein subunits of the $G\alpha_q$ class ($G\alpha_q$, $G\alpha_{11}$, $G\alpha_{14}$ and $G\alpha_{16}$) activate phosphoinositide-specific phospholipase C (PI-PLC) isozymes [67]. PI-PLCs hydrolyze the phosphoester bond of the plasma membrane lipid phosphatidylinositol 4,5-bisphosphate [$\text{PtdIns}(4,5)\text{P}_2$], generating the ubiquitous second messengers inositol 1,4,5-trisphosphate [$\text{Ins}(1,4,5)\text{P}_3$] and diacylglycerol (DAG) [67]. Regulation of PLC isozymes by heterotrimeric G-proteins is discussed in a subsequent section.

$G\alpha_{12/13}$ proteins can regulate the small G-protein RhoA via effectors that possess Dbl-homology (DH) and pleckstrin-homology (PH) domain cassettes characteristic of Rho-family guanine nucleotide exchange factors [68]. Activated $G\alpha_{12}$ and $G\alpha_{13}$ subunits can stimulate PDZ-RhoGEF activity [69, 70]; in common with activated $G\alpha_q$, $G\alpha_{12/13}$ subunits are also capable of stimulating the activity of leukemia-associated RhoGEF (LARG) [71, 72]. Furthermore, $G\alpha_{13}$ (but not $G\alpha_{12}$) can stimulate p115RhoGEF activity [73, 74]. Each of these three RhoGEFs activate RhoA by promoting exchange of GDP for GTP which, in the case of constitutive over-activation, can result in cell transformation [75–78].

$G\beta\gamma$ effectors

The $G\beta\gamma$ dimer was once thought only to facilitate coupling of $G\alpha\beta\gamma$ heterotrimers to GPCRs and act as a $G\alpha$ inhibitor given its guanine nucleotide dissociation inhibitor (GDI) activity. However, it is now known that, following dissociation of $G\alpha\cdot\text{GTP}$, $G\beta\gamma$ is free to activate a large number of its own effectors [21, 24]. The first $G\beta\gamma$ effectors identified were the G-protein-regulated inward-rectifier K^+ channels (GIRK or $\text{K}_{\text{ir}}3$ channels) [79]. Since then, $G\beta\gamma$ has been found to bind directly to both the N- and C-termini of GIRK1–4 [80–85]. GIRK channels are synergistically activated by $\text{PtdIns}(4,5)\text{P}_2$, intracellular Na^+ and $G\beta\gamma$ [86, 87]. Neuronal N- and P/Q-type Ca^{2+} channels are also regulated by both $G\alpha$ and $G\beta\gamma$ subunits [88–90]. A number of findings suggest that the interaction between $G\beta\gamma$ and Ca^{2+} channels is direct. For example, overexpression of $G\beta\gamma$ in various cell lines inhibits Ca^{2+} channel activity [91], while overexpression of $G\beta\gamma$ scavengers, such as the C-terminus of G-protein-coupled receptor kinase-2 (GRK2), suppresses this effect [88]. Furthermore, mutation of residues within the putative $G\beta\gamma$ binding site on the α_1 pore-forming subunit of Ca^{2+} channels eliminates channel inhibition caused by GPCR activation [91–93].

$G\beta\gamma$ subunits can also regulate kinases and small G-proteins. Activation of certain GPCRs results in $G\beta\gamma$ -mediated stimulation of ERK1/2, JNK and p38 mitogen-activated protein kinases (MAPKs); a response that is inhibited by agents that sequester $G\beta\gamma$ dimers [94–97]. Phosphoinositide-3' kinase- γ (PI3K γ), a key signaling enzyme found downstream of GPCRs in leukocytes, is directly activated by $G\beta\gamma$ subunits [98–101]. $G\beta\gamma$ has been shown to both positively and negatively regulate various AC isoforms [102–104], activate PLC- β and PLC- ϵ [67, 105, 106], and localize GRK2 and GRK3 to the plasma membrane (reviewed in [107, 108]). A recent exciting finding has been the purification of a $\text{PtdIns}(3,4,5)\text{P}_3$ -dependent Rac nucleotide exchange factor (P-Rex1) from neutrophil extracts [109]. The P-Rex1 protein serves as a coincidence detector for PI3K and $G\beta\gamma$ signaling to facilitate Rac activation [109]. $\text{PtdIns}(3,4,5)\text{P}_3$ produced from receptor-mediated PI3K γ activation synergizes with receptor-mobilized free $G\beta\gamma$ to regulate Rac activation via the tandem DH/PH domains of P-Rex1 [109]. Although P-Rex1 has a PH domain (along with DH, tandem DEP, tandem PDZ and inositol phosphatase domains), its $G\beta\gamma$ interaction site has yet to be delineated.

In general, the mechanism of $G\beta\gamma$ interaction with its effectors is not entirely clear. Many, but not all, $G\beta\gamma$ effectors contain PH domains; however, not all PH domain-containing proteins interact with $G\beta\gamma$, making the prediction of all PH-domain $G\beta\gamma$ interaction sites challenging. The molecular determinants of $G\beta_1\gamma_2$ interaction with the GRK2 PH domain has recently been elu-

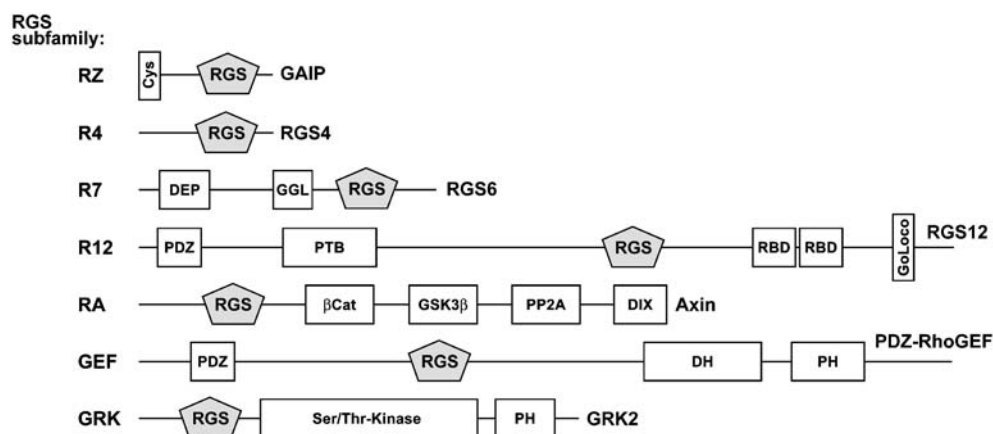

Figure 3. Schematic of the varied multi-domain architectures of RGS family proteins. RGS subfamily nomenclature follows that first established by Wilkie and Ross [318]. Abbreviations used are Cys (cysteine-rich region), RGS (Regulator of G-protein Signaling domain), DEP (Dishevelled/EGL-10/Pleckstrin homology domain), GGL (G γ -like domain), PDZ (PSD-95/Dlg/ZO-1 homology domain), PTB (phosphotyrosine binding domain), RBD (Ras binding domain), GoLoco (G $\alpha_{i/o}$ -Loco interacting motif), β Cat (β -catenin binding domain), GSK3 β (glycogen synthase kinase-3 β binding domain), PP2A (phosphatase PP2A binding domain), DIX (domain present in Dishevelled and Axin), DH (Dbl homology domain), PH (Pleckstrin homology domain), Ser/Thr-kinase (serine-threonine kinase domain).

culated by Tesmer and colleagues [110], and this may provide a basis for the discovery of novel PH-domain containing G $\beta\gamma$ effectors.

The G-protein signaling field is becoming increasingly populated with findings of cross-talk and integration between previously 'distinct' signaling pathways, and thus many new targets of G α and G $\beta\gamma$ regulation are being described. In such situations, a clear distinction between 'direct' and 'indirect' effectors should be made. The test for the former should ideally include demonstrations of (i) direct interaction between homogenous purified components, but also (ii) physiologically relevant (i.e. endogenous) interaction of proposed signaling partners.

Regulation of heterotrimeric G-protein signaling

RGS domain-containing proteins

It was originally thought that the duration of heterotrimeric G-protein signaling could be modulated by only two factors: the intrinsic GTP hydrolysis rate of the G α subunit and acceleration of that rate by certain G α effectors such as PLC- β [111]. In 1996, several groups discovered a new family of GTPase-accelerating proteins (GAPs) for G α proteins: the 'regulators of G-protein signaling' or RGS proteins (fig. 3) [112–114]. Each RGS protein contains a hallmark ~120 amino-acid 'RGS domain' – a nine-alpha-helix bundle which contacts the G α switch regions, stabilizing the transition state for GTP hydrolysis [37, 41]. Many RGS proteins catalyze rapid GTP hydrolysis by isolated G α subunits in vitro and attenuate agonist/GPCR-stimulated cellular responses in vivo [115]. Because of their GAP activity, RGS proteins

are now considered key desensitizers of heterotrimeric G-protein-signaling pathways.

RGS proteins are no longer considered exclusively as desensitizing agents, but also as scaffolds that coordinate multiple components of GPCR signaling to overcome diffusional limitations and facilitate rapid, receptor-specific signal onset and termination. For example, studies of GPCR signaling to G-protein-regulated inward rectifier potassium (GIRK) channels have found that RGS1, -2, -3, -4, -5, -7 and -8 accelerate both the activation and deactivation kinetics of agonist-dependent GIRK currents without necessarily altering either current amplitudes or steady-state dose-response relationships [116–121]. Modulatory effects of RGS proteins on GPCR signaling are not easily predicted solely on the basis of RGS domain-mediated G α GAP activity. There is an emerging view that RGS domain-containing proteins have multifaceted functions in signal transduction.

As shown in figure 3, several RGS family members contain multiple signaling and scaffolding domains. The R7 subfamily of RGS proteins, consisting of RGS6, -7, -9 and -11, have an additional domain that interacts with G β_5 subunits: the G-protein γ subunit-like (GGL) domain [122–125]. R7 subfamily members contain not only the GGL domain, but also a DEP (Dishevelled/EGL-10/Pleckstrin) homology domain, likely important for membrane targeting [126, 127]. RGS12 contains several protein-protein interaction domains including a PDZ (PSD95/Dlg/ZO-1) domain, which binds GPCR C-termini in vitro and a phosphotyrosine binding (PTB) domain that facilitates phosphotyrosine-dependent recruitment of RGS12 to the α 1B-subunit of the N-type calcium channel [128, 129]. In addition, RGS12 and its R12 subfamily

member, RGS14, contain tandem Ras-binding domains (RBDs) [130]; in the case of RGS14, these RBDs bind the Rap subfamily of small G-proteins [131]. RGS12 and RGS14 also share a single GoLoco motif that binds $G\alpha_i$ subunits [132–134]. Members of the RhoGEF subfamily of RGS proteins couple GPCR activation to RhoA via $G\alpha$ binding to their N-terminal RGS domains and the consequent activation of the RhoA-directed GEF activity embodied in their tandem DH/PH domains [70, 71, 73, 74, 135].

GRK2 is involved in desensitization and downregulation of GPCR activation via phosphorylation of the intracellular loops and carboxy-terminus of activated GPCRs; GRK2 has also been shown to act as an effector antagonist for $G\alpha_q$ via its conserved RGS domain [136, 137]. The recent structural determination of GRK2 in complex with $G\beta_1\gamma_2$ underscores the fact that GRKs are multifaceted signaling regulators given the ability of GRK2 to directly attenuate $G\alpha_q$, $G\beta_1\gamma_2$ and GPCR signaling [110]. Mounting evidence suggest distinct modalities of regulation by GRKs may apply for different GPCRs. For instance, GRK2 regulates metabotropic glutamate receptor signaling by a kinase-independent mechanism, presumably by sequestration of both $G\alpha_q$ and $G\beta\gamma$ subunits [138, 139]. This is in stark contrast to the traditional model of regulation (such as that of the β -adrenergic receptor), in which GRK2 phosphorylates the receptor to facilitate arrestin binding, thus preventing further G-protein activation while also facilitating downstream signaling cascades [140].

Further insight into the regulatory mechanisms governing GRK2-mediated desensitization has recently been described [141]. The Raf kinase inhibitor protein (RKIP) is a physiological inhibitor of both GRK2 and Raf-1 [141, 142]: RKIP can sterically inhibit protein-protein interactions transacted by both kinases. Lorenz and co-workers observed that GPCR activation causes protein kinase-C (PKC)-mediated phosphorylation of RKIP on Ser153 [141]. Ser153 phosphorylation is sufficient to change RKIP specificity from Raf-1 to GRK2. Thus, a two-pronged facilitation of GPCR signaling can occur: PKC activity removes tonic inhibition of Raf-1 by RKIP and, simultaneously, GRK2-mediated phosphorylation and internalization of the GPCR is prevented. Hence, this is a novel mechanism of positive feedback for GPCR signaling or, potentially, cross-talk between GPCRs coupled to different effector pathways (e.g. PLC/PKC versus MAPK). Provocatively, the site of RKIP/GRK2 interaction maps to the N-terminal 185 amino acids of GRK2. This region encompasses the RGS domain of GRK2. Thus, it is tempting to speculate that RKIP binds to the GRK2 RGS domain. Defining the molecular determinants of this protein complex could shed additional light on $G\alpha$ -independent protein-protein interactions mediated by RGS domains, as first identified in the case of the Axin RGS

domain binding to the adenomatous polyposis coli (APC) tumor suppressor protein [143].

Novel G-protein signaling regulators

PLC- ϵ : a multifunctional nexus for heterotrimeric and monomeric G-protein signaling pathways

Stimulation of phosphoinositide-hydrolyzing PLC isozymes by extracellular stimuli such as neurotransmitters, hormones, chemokines, inflammatory mediators and odorants is one of the major signal transduction pathways used by cell surface receptors to mediate downstream signaling events [144]. At least five classes of PLC isozymes underlie these signals: PLC- β , PLC- γ , PLC- δ , PLC- ϵ and PLC- ζ (fig. 4) [67, 145]. Until recently, PLC- β was the isozyme most commonly found to be activated by GPCRs and heterotrimeric G-proteins. GPCRs activate PLC- β enzymes either via release of α -subunits of the G_q family of G-proteins [146–149] or by $G\beta\gamma$ dimers from activated G_i family members [105, 150, 151]. In contrast, PLC- γ , PLC- δ and PLC- ζ isoforms differ largely in their regulatory mechanisms. PLC- γ enzymes are regulated by receptor and non-receptor tyrosine kinases [152–154]. PLC- δ isoforms may be regulated by Ca^{2+} [155] and/or the high-molecular-weight G-protein (G_h) [67, 156]; however, the mechanisms by which PLC- δ enzymes couple to and are regulated by membrane receptors is less clear [67]. PLC- ζ , the most recently identified PLC isozyme, is reportedly responsible for sperm-mediated Ca^{2+} oscillations that occur during fertilization [145].

A novel class of PI-PLC was first revealed with the identification of the protein PLC210 in a screen for *Caenorhabditis elegans* Ras (LET-60) effectors [157]. Cloning of the full coding sequence of PLC210, the prototypical member of the PLC- ϵ family, identified functional domains not previously described in other PLCs. PI-PLCs generally contain a PH domain, an EF-hand domain, X and Y catalytic domains, and a C2 domain (notably PLC- ζ lacks a PH domain) (fig. 4). However, PLC210 and mammalian PLC- ϵ uniquely possess an N-terminal CDC25-homology domain and two C-terminal Ras-associating (RA) domains [157–160]. It is now known that upstream regulators of PLC- ϵ include Ras subfamily [158, 160] and Rho subfamily [161] GTPases, as well as subunits of the heterotrimeric G-protein family [106, 159]. Activation of PLC- ϵ by GPCRs coupled to $G\alpha$ subunits of the $G_{i/o}$, $G_{12/13}$ and G_s families has also been demonstrated, revealing that PLC- ϵ is yet another PLC isozyme regulated by GPCRs [162–164]. In addition to generating the second messengers $Ins(1,4,5)P_3$ and diacylglycerol, PLC- ϵ has also been shown to trigger other downstream signals independent of its phosphoinositide-hydrolyzing activity. PLC- ϵ , via

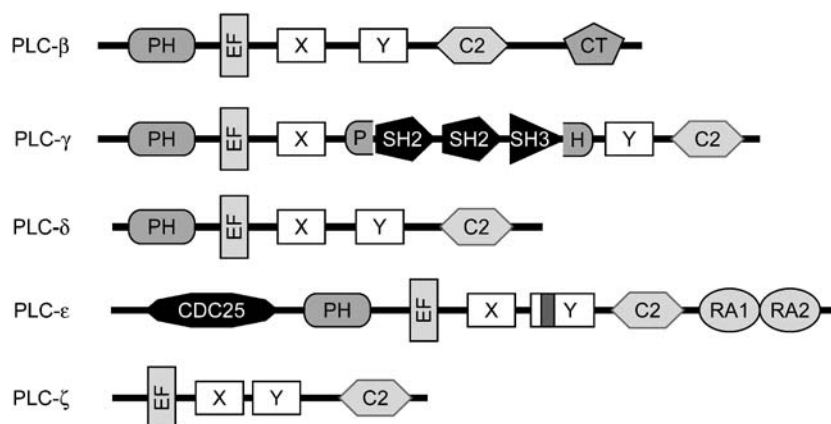

Figure 4. Domain architecture of mammalian PLC family members. Hallmarks of phospholipase C (PLC) family members are an N-terminal PH domain, which binds $G\beta\gamma$ subunits, and EF, X, Y and C2 motifs forming the catalytic core for phosphoinositide hydrolysis. PLC- β can be activated by $G\alpha_q$ through a unique C-terminal (CT) domain [319], which also acts as a $G\alpha_q$ GAP [111]. Unique to PLC- γ are two Src-homology-2 (SH2) domains and a Src-homology-3 (SH3) domain that bisect the PH domain. The SH2 domains confer sensitivity to stimulation by PDGF and EGF receptors, whereas the SH3 domain has been shown to act as a GEF for the phosphatidylinositol-3' kinase (PI3K) enhancer, PIKE [320]. PLC- ϵ interacts with a variety of small GTPases through domains not found in other PLCs. An N-terminal CDC25 (cell division cycle protein 25-like) domain has been shown to promote guanine nucleotide exchange of Ras-family GTPases such as H-Ras and Rap1A, whereas the second Ras-associating (RA) domain (RA2) is reported to bind to H-Ras and Rap in a GTP-dependent fashion; the first RA domain (RA1) displays weak affinity for H-Ras and binds independent of nucleotide state. In addition, RhoA, RhoB and RhoC can activate PLC- ϵ through a unique 60–70-amino acid insert (shaded box) in the Y domain [161]; other Rho family members such as Rac1, Rac2, Rac3 and Cdc42 do not interact with PLC- ϵ .

the CDC25-homology domain at its amino terminus, functions as a GEF for Ras-family GTPases [159, 160, 165, 166]. In light of these findings, PLC- ϵ appears to be a candidate scaffold protein to integrate and mediate cross-talk between monomeric and heterotrimeric G-proteins [167].

PLC- ϵ contains tandem Ras-associating domains (RA1 and RA2) (fig. 4); thus, the observation that various monomeric G-proteins activate PLC- ϵ was not surprising. However, further examination of small GTPase activation of PLC- ϵ has revealed that both RA-dependent as well as RA-independent interactions can occur. Specifically, the Ras family G-proteins H-Ras, TC21, Rap1A, Rap2A and Rap2B stimulate PLC- ϵ in an RA2-dependent manner, whereas Ral, Rho and Rac activation of PLC- ϵ appears to be primarily RA independent [158, 161, 164]. The mechanism by which Ral and Rac activate PLC- ϵ is unknown; however, the interaction and mode of activation of PLC- ϵ by Rho has been elucidated [158, 161, 164, 168]. Wing and colleagues [161] identified a unique 65-amino acid insert within the catalytic core of PLC- ϵ , not present in other PLC isozymes, as the region within PLC- ϵ that imparts responsiveness to Rho. Interestingly, this region also appears to be essential for $G\alpha_{12/13}$ activation of PLC- ϵ . Thus, it is possible that $G\alpha_{12/13}$ activation of a Rho-GEF such as p115RhoGEF or LARG leads to activation of Rho and subsequently of PLC- ϵ . Heterotrimeric G-protein activation of PLC- ϵ by $G\alpha_{12}$, $G\alpha_{13}$, $G\alpha_s$ and $G\beta\gamma$ has been demonstrated upon cellular co-transfection [106]; however, whether heterotrimeric G-protein-mediated activa-

tion requires direct interaction of these subunits with PLC- ϵ is unclear. Demonstration that PLC- ϵ activation occurs via monomeric GTPases known to be downstream of heterotrimeric G-proteins suggests that heterotrimeric G-protein-promoted PLC- ϵ stimulation is more likely indirect, and more closely resembles that of the novel PLC- β interactions described below.

Until recently, regulation of PLC- β isozymes by GPCRs was thought to occur primarily via direct interactions with either $G\alpha$ subunits of the G_q family or $G\beta\gamma$ subunits [67]. However, the assumption that PLC- β signaling is solely regulated by heterotrimeric G-proteins was dramatically altered with the observation by Illenberger and colleagues that members of the Rho subfamily of small GTPases, specifically Rac1 and Rac2, activate PLC- β isozymes [169, 170]. This finding raises the question of how integrated regulation of these isozymes by small GTPases and heterotrimeric G-proteins occurs, and within what signaling cascades this phenomenon elicits specific cellular responses. In addition, these findings highlight the possibility that heterotrimeric G-protein activation of PLC- β isozymes might be synergistic via direct and indirect mechanisms involving $G\beta\gamma$. For instance, $G\beta\gamma$ subunits can activate Rac directly via the Rac-GEF P-Rex1 [109], as previously mentioned. Thus, it may be that in certain signaling cascades, $G\beta\gamma$ subunits from heterotrimeric G-proteins might stimulate PLC- β directly and activate a Rac-GEF such as P-Rex1 to increase Rac-GTP levels, thus activating PLC- β indirectly. Although PLC- β activation via this type of mechanism

has not been demonstrated, activation of PLC- ϵ by G α_s -coupled receptors via a similar pathway has been described, as detailed below.

Schmidt and colleagues [162, 171, 172] made the observation that G α_s -coupled receptors are capable of activating PLC- ϵ , and that this activation is dependent upon both heterotrimeric and monomeric G-proteins. Specifically, β_2 -adrenergic-, M $_3$ -muscarinic- and prostaglandin E $_1$ receptor-mediated activation of PLC- ϵ was reported [162, 171], with the mechanism of activation hypothesized as follows. G α_s -coupled receptors stimulate adenylyl cyclase, which results in increased cyclic AMP levels and thus activation of the Rap-GEF EPAC (exchange protein activated by cAMP) [173, 174]. Once activated, EPAC is thought to catalyze GTP loading on Rap2B, leading to activation of PLC- ϵ . In addition to providing a potential mechanism by which GPCRs activate a PLC isozyme via integration of heterotrimeric and monomeric G-protein signaling, the findings of Schmidt and colleagues also provide evidence for a positive interaction between cAMP-promoted and PLC signaling pathways.

In addition to GPCR-mediated stimulation of PLC- ϵ , tyrosine kinase receptor-mediated regulation has been observed. Receptor tyrosine kinases such as those for the epidermal growth factor (EGF) and platelet-derived growth factor (PDGF) have been shown to activate PLC- γ enzymes by recruitment of the enzyme to the autophosphorylated receptor and subsequent tyrosine phosphorylation [67]. In contrast, the mechanism of PLC- ϵ activation by tyrosine kinase receptors appears to involve small GTPases. Specifically, Ras and Rap GTPases have been reported to participate in the activation of PLC- ϵ in a number of cell types [160, 164–166]. The mechanism of activation of PLC- ϵ by these GTPases appears to involve the RA2 domain, as mutations in RA2 either reduce or completely inhibit activation of the enzyme by the EGF receptor [164].

The direct contribution of PLC- γ to the activation of PLC- ϵ has also been examined. Song et al. found that a platelet-derived growth factor (PDGF) receptor mutant, deficient with respect to PLC- γ activation, still activates PLC- ϵ , via H-Ras and Rap1A as intermediaries [165]. Recently, however, Stope et al. reported that the mechanism of PLC- ϵ stimulation by the EGF receptor in HEK-293 cells involves not only small GTPase activation, but also PLC- γ mediated activation [175]. Specifically, the EGF receptor was identified as a 'platform' that assembles and activates two direct effectors, PLC- γ 1 and the nonreceptor tyrosine kinase c-Src. Upon activation, PLC- γ 1 and c-Src recruit and activates the Ca $^{2+}$ /diacylglycerol-regulated guanine nucleotide exchange factor for Ras-like GTPases, RasGRP3, via second messenger formation and tyrosine phosphorylation, respectively. Once active, RasGRP3 catalyzes nucleotide exchange on Rap2B,

inducing activation of this small GTPase. Active Rap2B then binds to PLC- ϵ and translocates the lipase to the plasma membrane where it can efficiently propagate signaling.

The molecular mechanisms of PLC- ϵ regulation have been intensively studied; however, little is known about the function of PLC- ϵ in physiological processes. Studies indicate that the regional and temporal expression profile of each PLC isoform may account for its physiological function [67]. For example, PLC- β 1 is highly expressed in the hippocampus and cerebral cortex [176], and PLC- β 1 knockout mice exhibit minor developmental abnormalities in the hippocampus and develop epilepsy [177]. To begin to understand the physiological function of PLC- ϵ , Kataoka and colleagues examined the spatial and temporal expression patterns of PLC- ϵ in the central nervous system of mouse embryos and adults [178]. The induction of PLC- ϵ expression appears to be associated specifically with the commitment of neuronal precursor cells to the neuronal lineage, and seems to persist after terminal differentiation into neurons [178]. In contrast to PLC- β 1, which exhibits region-specific expression [176], PLC- ϵ expression is observed in almost all regions containing mature neurons [178]. These results suggest that PLC- ϵ may be involved in a more general aspect of neuronal differentiation and neuronal function than a region-specific isoform such as PLC- β 1, which is critical for very selective neuronal functions such as those associated with the hippocampus. It is possible that PLC- ϵ , via Ras and/or Rap regulation, may have a general role in fibroblast growth factor and neurotrophic factor signaling, both of which have been implicated in neuronal development. Recently, the physiological function of PLC- ϵ in the nematode *C. elegans* was addressed. *C. elegans* ovulation and fertility are regulated by an Ins(1,4,5)P $_3$ signaling pathway activated by the receptor tyrosine kinase LET-23 [179, 180]. PI-PLCs generate Ins(1,4,5)P $_3$ by catalyzing the hydrolysis of PtdIns(4,5)P $_2$ into Ins(1,4,5)P $_3$; thus, it is possible that an enzyme involved in generation of Ins(1,4,5)P $_3$ would also play an important regulatory role in fertility and ovulation. Kataoka and colleagues used deletion mutants of the PLC- ϵ gene in *C. elegans*, *plc-1*, to investigate the role of the gene in ovulation. Two deletion alleles were generated that removed regions important for the catalytic activity of PLC- ϵ , and both exhibited reduced fertility as a result of ovulation defects [181]. This is the first genetic analysis of PLC- ϵ in an intact organism, and adds further complexity to our understanding of the potential role(s) PLC- ϵ is playing in physiological processes. Future studies examining the cellular function and regulation of PLC- ϵ both in vitro and in vivo will help to merge the gap between molecular and functional analyses of PLC- ϵ regulation, and thus provide evidence in support of PLC- ϵ as a critical player in mammalian physiology.

In addition to regulation of PLC- ϵ , other novel forms of PLC regulation have recently been revealed. PLC-L2 is a novel PLC-like protein that is most similar to PLC- δ but lacks lipase activity due to replacement of a conserved histidine residue in the X domain [182]. PLC-L2 is expressed in hematopoietic cells, where PLC- γ 1 and - γ 2 play important roles downstream of the T cell receptor (TCR) and B cell receptor (BCR), respectively [183]; however, the physiological role of this catalytically inactive PLC in these cells was unknown. Recently, Takenaka et al. generated mice with a targeted deletion of the *PLC-L2* gene to examine the role of PLC-L2 in hematopoietic cell signaling [184]. When PLC-L2 is absent, B cells exhibit a hyper-reactive phenotype which strongly suggests that the physiological role of PLC-L2 is to negatively regulate BCR signaling and immune responses.

The finding that PLC-L2 negatively regulates signaling indicates that PLCs may play more complex roles in signaling cascades than originally thought. With the recent discovery of two new PLCs, PLC- ϵ and PLC- ζ , the physiological functions of PLCs are constantly being redefined.

Receptor-independent guanine nucleotide exchange factors

In the past few years there have been several reports of receptor-independent activators of G-protein signaling. Cismowski and colleagues used a yeast-based screen to identify potential receptor-independent activators of heterotrimeric G-protein signaling [185]. One gene isolated in this screen was *Dexas1* (renamed by Cismowski et al. as *AGS1*), a previously described dexamethasone-inducible Ras-family GTPase [186]. *Dexas1* has been characterized as a putative GEF for $G\alpha_i$ subunits [187] and can regulate heterotrimeric G-protein signaling pathways under certain circumstances [188, 189]. Intriguingly, *Dexas1* was also shown to be activated by N-methyl-D-aspartate (NMDA) receptor-dependent nitric oxide (NO) production in vitro and in vivo [190]. A recent study has further characterized *Dexas1* as a regulator of the circadian clock via NMDA and $G\alpha_i$ dependent pathways [191]. *Dexas1* is highly expressed in the suprachiasmatic nucleus, the 'pacemaking' centre of circadian rhythm control [192]. Mice deficient in *Dexas1* are abnormal in both photic (NMDA-dependent) and non-photic (neuropeptide Y-dependent) responses, probably via modulation of $G\alpha_i$ signaling pathways [191].

Recently Tall and colleagues identified mammalian Ric-8A (Synembryn) as a receptor-independent GEF for $G\alpha_{q/i/o}$, but not $G\alpha_s$, using in vitro assays [193]. The inability of Ric-8A to activate $G\alpha$ subunits bound within heterotrimeric $G\alpha\beta\gamma$ complexes has led to the hypothesis that Ric-8 proteins may act as signal amplifiers following

initial heterotrimer activation by GPCRs [193]. More recently, we have shown that Ric-8 plays a fundamental role in regulating G-protein signaling during *C. elegans* asymmetric cell division in embryogenesis (discussed in detail below).

GoLoco motif-containing proteins

In a genetic screen in *Drosophila* to discover glial cell-specific targets of the transcription factor *pointed*, Granderath and colleagues cloned *Drosophila loco* (for 'locomotion defects'), the fly orthologue to *RGS12* [194]. This group also identified a $G\alpha$ -interacting region in *Loco* that was distinct from the RGS domain. Using this information and the sequences of other described $G\alpha$ -interacting proteins, we discovered a conserved 19-amino acid sequence motif, dubbed the $G\alpha_{i/o}$ -*Loco* or GoLoco motif, that is present in *Loco*, *RGS12*, *RGS14* and many other metazoan proteins [195]. A similar in silico discovery was independently made by Ponting [130], and GoLoco motifs have also been referred to as G-protein regulatory (GPR) motifs [196]. The GoLoco motif/ $G\alpha$ interaction is generally selective for $G\alpha_i$ subunits in their GDP-bound form; the interaction results in a slowing of the spontaneous GDP release by $G\alpha$. The molecular determinants of GoLoco motif-mediated GDI activity [133], as well as the putative roles of these proteins as regulators of GPCR signaling and cell division processes are discussed at length in our recent review [134].

GoLoco motifs, either individually or in tandem repeats, have been discovered within several diverse proteins (fig. 5) including *C. elegans* GPR-1/2 [197–199], *Drosophila* Pins [200, 201] and the mammalian proteins Purkinje cell protein-2 (*Pcp-2*) [202, 203], Rap1GAPII [204, 205], G18 [206, 207], LGN [208–210] and AGS3 [196, 211, 212]. As many of the GoLoco motif-containing proteins have two or more names, the Human Genome Organization (HUGO <http://www.gene.ucl.ac.uk/nomenclature/>) has reclassified some of the human GoLoco motif proteins using a standardized nomenclature: AGS3 is now called G-protein signaling modulator-1 (GPSM1), LGN (also known as mammalian Pins; [213]) is called GPSM2, G18 (also called NG1 and AGS4) is now named GPSM3, and *Pcp-2* (a.k.a. L7) is now GPSM4.

G-protein signaling in model organisms

Many eukaryotic organisms employ heterotrimeric G-proteins for signal processing and homeostasis. For instance, the budding yeast *Saccharomyces cerevisiae* responds to peptide 'pheromones', a-factor and α -factor, to accomplish mating (haploid cell fusion). Pheromone signaling in yeast is propagated and regulated via GPCRs, heterotrimeric G-proteins and a $G\beta\gamma$ -mediated

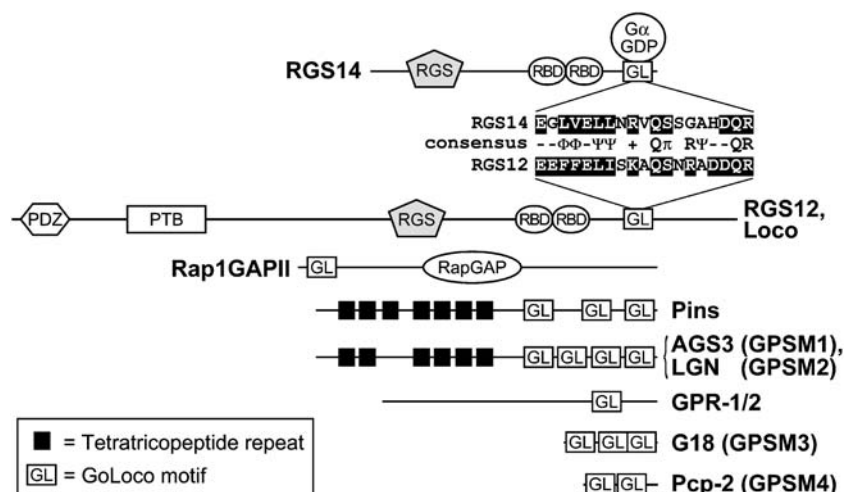

Figure 5. The 19-amino acid GoLoco motif is found in a diverse set of signaling regulatory proteins. Domain organization of single- and multi-GoLoco motif-containing proteins is illustrated. Abbreviations used are RGS (Regulator of G-protein Signaling domain), RBD (Ras binding domain), GoLoco or GL ($G\alpha_{i/o}$ -Loco interacting motif), PDZ (PSD-95/Dlg/ZO-1 homology domain), PTB (phosphotyrosine binding domain), RapGAP (Rap-specific GTPase-activating protein domain), GPSM (G-protein-signaling modulator).

MAPK pathway [214]. The study of this system in yeast has provided enormous insight into G-protein-linked systems in mammals, mainly due to the tractability of the yeast system to genetic manipulation. For instance, the archetypal yeast RGS protein Sst2 was isolated in a genetic screen as a negative regulator of pheromone signaling [215], 14 years before the first functional identification of a mammalian RGS protein [112, 114]. Likewise, the slime mould *Dictyostelium discoideum* responds to bacterially secreted extracellular cyclic AMP (cAMP) [216] by chemotaxis and phagocytosis of the bacteria. This process is transacted by a canonical heterotrimeric G-protein signaling system and is akin to chemotactic and phagocytic processes in mammalian leukocytes [217]. This experimental system has provided superlative information about the cell biological mechanisms of directional sensing, polarization, cell motility and lipid metabolism controlled by G-protein-coupled pathways. The particulars of non-conventional G-protein signaling in *Drosophila* and *C. elegans* are discussed elsewhere in this review, while the genetic dissection of mammalian G-protein signaling via gene inactivation studies has recently been thoroughly reviewed in the literature [218].

A GPCR-RGS protein in plants?

An enigmatic, but potentially very enlightening, example of G-protein signaling exists in the *Plantae* model organism *Arabidopsis thaliana*. Heterotrimeric G-protein signaling in *Arabidopsis* controls both cell proliferation [219] and inhibition of stomatal opening by abscisic acid (via inhibition of guard cell inwardly rectifying K^+ channels) [220]. The *Arabidopsis* G-protein signaling repertoire

contains an unusually restricted set of elements. At present only one prototypical $G\alpha$ subunit (AtGPA1), one $G\beta$ subunit (AGB1) and two $G\gamma$ subunits (AGG1 and AGG2) have been described [221]. Metazoan systems typically have hundreds to thousands of GPCRs, 10–20 $G\alpha$ subunits, 2–5 $G\beta$ subunits and 2–12 $G\gamma$ subunits. Intriguingly, no definitive report of either an *Arabidopsis* GPCR or a direct effector of AtGPA1 has been made, although candidates have been identified [222, 223]. Similarly, until recently, no RGS protein nor GAP of any kind for $G\alpha$ had been identified in *Arabidopsis*. We discovered the first plant RGS protein, subsequently named AtRGS1, as an anonymous open-reading frame with homology to mammalian RGS domains [224]. Provocatively, AtRGS1 contains an N-terminal region with the predicted topology and structure of a GPCR (fig. 6) [225], bringing forth the possibility that AtRGS1 is a conjoint guanine nucleotide exchange factor and GTPase-accelerating protein for AtGPA1. The RGS domain of AtRGS1 acts as a potent GAP for AtGPA1 in vitro [224, 225]. In vivo, the phenotype of AtRGS1 ablation or overexpression is consistent with the role of AtRGS1 as a negative regulator of AtGPA1 signaling, based on analyses of cell proliferation in the apical root meristem [224]. Currently, no evidence exists as to whether the 7TM component of AtRGS1 is a guanine nucleotide exchange factor for AtGPA1, and the identity of potential ligands remains elusive, although a sugar is a most likely candidate [226].

The ultimate receptor-selective RGS protein?

Evidence from mammalian systems has brought forth the hypothesis that RGS protein regulation of $G\alpha$ signaling can be ‘receptor selective’ [227–229]. For instance, RGS1 is a 1000-fold more potent inhibitor of muscarinic-

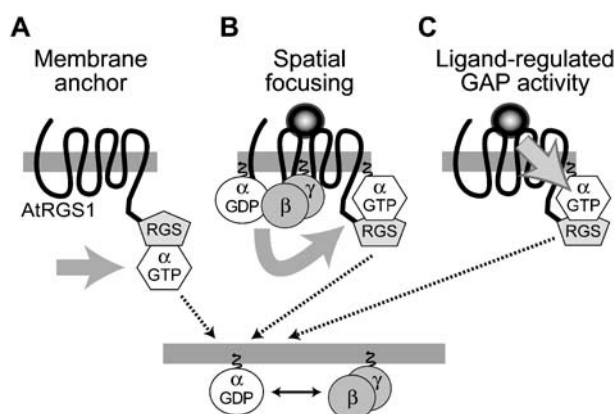

Figure 6. Proposed models of AtRGS1 signaling interactions. (A) In the ‘Membrane anchor’ scenario, AtRGS1 acts to recruit (grey arrow) activated AtGPA1 to specific membrane microdomains, allowing localized signaling and deactivation by AtRGS1. (B) In the ‘Spatial focusing’ model, AtRGS1 is a ligand-activated GPCR that coordinately catalyzes both guanine nucleotide exchange on the *Arabidopsis* heterotrimer (grey arrow) and GTP hydrolysis by the activated G α subunit (dotted arrow). (C) In the third model, AtRGS1 is a ligand-regulated GAP: i.e. ligand-mediated agonism or inverse agonism regulates deactivation of AtGPA1-GTP via AtRGS1 RGS domain GAP activity.

versus cholecystokinin-receptor stimulated Ca²⁺ mobilization in pancreatic acinar cells; this is despite the receptor signaling pathways to G α_q being apparently indistinguishable [228]. The simplest mechanism for receptor selectivity would be direct interaction between GPCRs and RGS proteins. Alluring evidence supports the notion that some RGS proteins may be present in signaling complexes with GPCRs; for instance, the PDZ (PSD-95/Dlg/ZO-1 homology) domain of RGS12 directly interacts *in vitro* with peptides corresponding to the C-terminus of the interleukin-8 receptor B (CXCR2) [129]. In a similar fashion, a GST-fusion protein of the third intracellular loop of the M₁-muscarinic acetylcholine receptor can co-precipitate with ectopically expressed or purified recombinant RGS2 but not other RGS proteins [230], and this correlates with the high potency of RGS2 inhibition of M₁ versus other muscarinic acetylcholine receptor signaling. However, it is important to note that no cellular, nor even *in vitro*, interaction between a full-length GPCR and a full-length RGS protein has yet been described.

Thus in the *Arabidopsis* G-protein signaling paradigm, it may be that AtRGS1 is the archetypal example of receptor selectivity by RGS proteins. By having conjoint GEF and GAP activities, the AtRGS1 protein potentially forms a precisely controlled and localized signaling complex: the so-called ‘spatial focusing’ hypothesis (fig. 6). Thus the concept has evolved that receptor selectivity of RGS proteins determines functional signaling outcomes, and evidence now exists that RGS proteins, first identified as negative regulators of GPCR signaling, may actually

facilitate signal transduction by ‘spatial focusing’, as outlined by Neubig and colleagues [231]. This concept stems from demonstrations that RGS proteins can positively (as well as negatively) modulate GIRK channels. RGS proteins can accelerate both the activation and deactivation kinetics of GIRK channels without altering the current amplitude or dose-response relationship to agonist application [116, 117]. Similarly, in the presence of GTP, RGS proteins can potentiate receptor-mediated GTP γ S binding by G α subunits [231]. Thus, RGS proteins may add a level of selectivity to GPCR action by permitting effector activation exclusively within the proximity of the GPCR while providing (via GAP activity) a constant supply of G α -GDP for continued GPCR coupling [231].

Fat-free RGS protein membrane association

An alternative explanation for the domain structure of AtRGS1 is that the N-terminal 7TM segment acts solely as a membrane anchor for the C-terminal RGS domain. AtGPA1 is predicted to be N-terminally myristoylated and, therefore, plasma membrane localized. Thus, forced membrane localization will enhance interaction between the cognate G α and RGS domain pair. It is important to note that no mammalian RGS proteins have demonstrable transmembrane domains, although the RGS domain-containing sorting nexins, SNX13, -14 and -25, are reported to have one or two potential transmembrane-spanning sequences [232]. However, it has been established that phospholipid binding by RGS domains [233–235] and palmitoylation of RGS domains [236, 237] each can negatively affect the ability of RGS domains to serve as GAPs for G α subunits. Thus, it appears that interactions between lipids and RGS domains may be intimately linked to physiological function [238], and independent methods to evoke the membrane localization of RGS proteins may have evolved in plants versus mammals. In mammalian cells, the membrane translocation of RGS proteins can be induced by GPCRs [239] and constitutively activated G α subunits [240]; however, recent evidence suggests that significant differences exist between endogenous and ectopically overexpressed RGS proteins [241]. This can include the mislocalization, mistranslation and altered half-life of RGS proteins. Thus, the physiological relevance of the transcription and localization of ectopically expressed RGS proteins needs to be carefully evaluated.

Turning on the off signal?

An alternative, and provocative, hypothesis to explain the convergence of seven transmembrane and RGS domains in the same polypeptide is that AtRGS1 is a ligand-regulated GAP for AtGPA1 (fig. 6) whereby a soluble ligand serves to activate (agonist), or to repress (inverse agonist), AtRGS1 GAP activity. The kinetic parameters

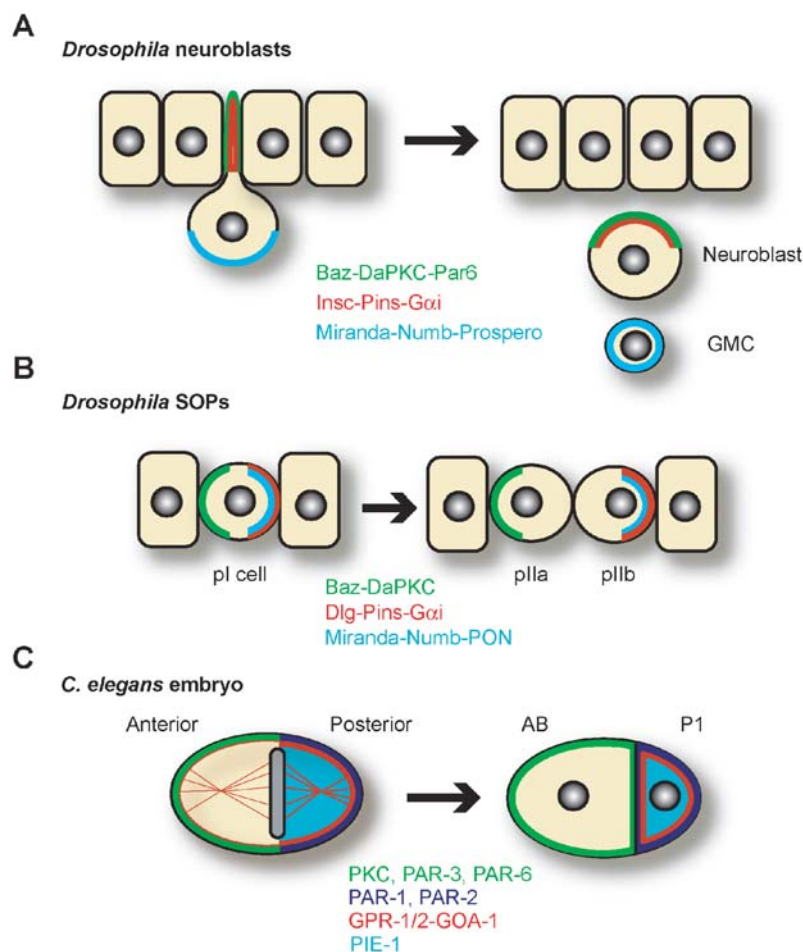

Figure 7. Models of asymmetric cell division in *Drosophila* and *C. elegans*. (A) In delaminating neuroblasts, two apical complexes (Bazooka [Baz], atypical protein kinase C [DaPKC] and Par6; Inscuteable [Insc], Partner of Inscuteable [Pins] and Gαi) facilitate the localization of cell-fate determinants to the basal lateral membrane and the orientation of the mitotic spindle. (B) In sensory precursor (SOP) cells, planar polarity is established by counteracting complexes of Baz-DaPKC towards the posterior and Discs Large (Dlg)-Pins-Gαi towards the anterior. (C) In *C. elegans* one-cell zygotes, PAR-1/-2 proteins enrich GPR-1/2-GOA-1 complex localization towards the posterior, resulting in greater astral microtubule pulling forces on the posterior spindle pole and a resultant smaller P1 daughter cell.

of the *Arabidopsis* G-protein cycle support this scenario, given that AtGPA1 has a rapid nucleotide exchange rate but slow intrinsic GTP hydrolysis activity [225]. Unfortunately, for a definitive answer to these questions, a ligand for AtRGS1 needs to be discovered. Deorphaning putative GPCRs is inherently problematic [242]. Despite massive effort, a wealth of knowledge about mammalian signal transduction, and a broad range of techniques to measure well-characterized G-protein effector systems, only a small quotient of orphan GPCRs have had ligands identified for them [242]. Accordingly, more information needs to be ascertained about AtGPA1 signaling through the use of genetic and biochemical approaches. The biochemical characterization of direct effectors, such as the putative AtGPA1 effector phospholipase-D α1 (PLDα1) [223], and the creation of robust cell biological assays, is a necessity for any deorphaning effort. Conversely, genetic studies may serve to elucidate a ligand for AtRGS1.

To this end, a recent report suggests that sphingosine 1-phosphate (S1P) is a potential plant-GPCR ligand. Abscisic acid inhibits stomatal opening caused by the activation of sphingosine kinase and, consequently, the production of S1P [243]. In mammalian systems, S1P is a well-described intracellular and extracellular messenger that activates a large family of GPCRs [244]. Thus it is possible that S1P is a ligand for AtRGS1 or other candidate plant GPCRs. Future studies should be directed towards fully elucidating the signaling components of this pathway. The potential for a novel receptor-activated GAP activity to occur in vivo seems highly likely as plants are the only sessile organisms known to utilize heterotrimeric G-protein signaling. Thus their mechanisms of signal perception and response to environmental conditions are likely to be dramatically different than that of the paradigmatic model organisms used to study G-protein signal transduction.

A novel role for heterotrimeric G-protein subunits in mitotic spindle force generation and asymmetric cell division

A non-canonical G-protein cycle is emerging from studies of asymmetric cell division. Asymmetric cell division (ACD) is a mechanism, used by metazoan organisms to create cellular diversity, in which two unique daughter cells are generated from a single precursor. In this process, cell-fate determinants are localized to one pole or another and the mitotic spindle is orientated such that, upon division, these cell-fate determinants are asymmetrically partitioned. Heterotrimeric G-proteins are associated with protein complexes that control cell polarity, and play an integral role in mitotic spindle pulling force generation (reviewed in [134, 245–247]). The fruit fly *D. melanogaster* and the nematode worm *C. elegans* are two model organisms commonly used for the study of asymmetric cell division. Both delaminating neuroblasts and sensory organ precursors in *Drosophila*, and the *C. elegans* early embryo, utilize a similar set of proteins to control polarity and spindle pulling forces (fig. 7A–C). The following sections detail the roles of heterotrimeric G-proteins in these two model systems and reviews what is known of related proteins in mammals.

Asymmetric cell division in *Drosophila*

Delaminating neuroblasts

In the *Drosophila* embryo, the central nervous system is derived from epithelial neuroprogenitor cells or ‘neuroblasts’ that divide asymmetrically into a smaller ganglion mother cells (GMCs) and larger neuroblasts (fig. 7A) [248]. After division, daughter GMCs terminally differentiate into neurons, whereas daughter neuroblasts retain their neural pluripotency. Neuroblast ACD is an intricate process that begins with delamination of cells from the neuroectoderm, followed by establishment of apical-basolateral cell polarity and localization of cell-fate proteins, and finally orientation of the mitotic spindle for division. Cell-fate determinants Miranda, Prospero and Numb are localized at the basolateral membrane of the dividing neuroblast where they segregate into the smaller GMCs. Prospero is a transcription factor that activates GMC-specific genes and inhibits neuroblast-specific genes [249–253]. *prospero* RNA is asymmetrically localized by Staufen, an RNA-binding protein [254–256]. The cortical localization of both Staufen and Prospero during mitosis are in turn controlled by the coiled-coil protein Miranda [257, 258]. Finally, the cell-fate determinant Numb, which is localized by partner of numb (PON), inhibits Notch signaling after the first division by polarizing the distribution of α -adaptin, resulting in enhanced endocytosis of Notch at one pole [259–262].

Orientation of cell polarity and mitotic spindle positioning for proper segregation of these cell-fate determinants requires a network of proteins that localize to the apical membrane at the beginning of mitosis as neuroblasts delaminate. At the apical membrane, a complex of $G\alpha_i$, Partner of Inscuteable (Pins), *Drosophila* atypical protein kinase C (DaPKC), *Drosophila* partitioning defect protein 6 (DmPAR6), Bazooka (Baz) and Inscuteable establish polarity cues and the axis of division. Inscuteable, a key player in this apical complex, is required for proper spindle orientation and localization of cell-fate determinants [263, 264]. Inscuteable binds to both Pins [201] and Bazooka [265], serving as the linchpin between Pins/ $G\alpha_i$ and Baz/DaPKC/DmPAR6 complexes (discussed below). Binding to both Baz and Pins occurs through a central asymmetry domain [265, 266] comprising a series of putative Armadillo repeats.

Pins is a multi-domain protein consisting of seven tetratricopeptide repeats (TPRs) at its N-terminus and three GoLoco motifs at its C-terminus (fig. 5). Consistent with other GoLoco motif proteins, Pins binds the GDP-bound form of *Drosophila* $G\alpha_i$, and the addition of GTP γ S to neuroblast lysates strongly inhibits coimmunoprecipitation of $G\alpha_i$ with Pins [267]. While a biochemical analysis of Pins has not been performed, closely related mammalian GoLoco motif proteins such as GPSM2 (LGN) and GPSM1 (AGS3) display GDI activity [209, 212, 268]. It appears that $G\alpha_i$ is the physiologically relevant G-protein, as $G\alpha_o$ is not detected in complex with Pins [267], and in general, the majority of GoLoco proteins display a strong preference for $G\alpha_i$ over $G\alpha_o$ subunits. Loss of Pins, Inscuteable or other apical components results in an increased rate of spindle misorientation and loss or mislocalization of cell-fate determinants. However, none of these result in the loss of asymmetric division. Partial recovery, known as telophase rescue, can occur in some cells lacking individual components of the apical cortex complex [269, 270]. This may be explained by recent studies suggesting that the two complexes (Baz/DaPKC/Par6 and Pins/ $G\alpha_i$) are at least partially redundant. While mutation of a single component results in spindle mislocalization, simultaneous mutation of components in both complexes results in symmetric division as well as the characteristic spindle misorientation and cell-fate determinant mislocalization [270]. Genetic studies by Izumi and colleagues suggest that the two complexes perform both overlapping and unique roles, where Bazooka localizes Miranda and partially contributes to asymmetry, and Pins/ $G\alpha_i$ orients the spindle and contributes to asymmetry [271]. The redundancy of the system suggests that asymmetry and spindle position are extremely important for viability.

The $G\beta$ subunit $G\beta 13F$ is also involved in regulating asymmetric cell division in *Drosophila* neuroblasts. Unlike $G\alpha_i$, $G\beta 13F$ has a uniform cortical distribution

[267]. Either elimination of $G\beta 13F$ or overexpression of $G\alpha i$ results in symmetric division [267, 272]. Until recently, it was unknown how $G\alpha$ - and $G\beta$ -subunits individually contributed to asymmetric division, as RNA-interference (RNAi) of $G\beta 13F$ expression also resulted in a concomitant loss of $G\alpha$. To ameliorate this, Yu et al. used $G\alpha i$ mutants to establish the relative roles of $G\alpha i$ and $G\beta 13F$ [273]. $G\alpha i$ mutants demonstrate similar phenotypes to those of Baz, Pins, DaPKC or Inscuteable mutants, where a fraction of cells still undergo asymmetric division. However, loss of $G\beta$ expression results in near complete (96%) loss of asymmetric division, similar to mutations to both the $G\alpha i$ /Pins and Baz/DaPKC pathways, leading to the proposal that $G\beta 13F$ acts upstream of the other components [273]. Cell-fate determinants are still localized accurately in $G\beta$ and $G\gamma$ double mutants, suggesting that the $G\beta\gamma$ dimer is primarily involved in spindle positioning rather than determinant localization. Furthermore, an increase in either $G\beta$ or $G\gamma$ expression results in small spindles, while a decrease in $G\beta$ expression results in large symmetric spindles [272]. Given the uniform cortical expression of $G\beta\gamma$, additional regulation by apical components must control $G\beta\gamma$ subunits in order for an asymmetric spindle to form [274]. The precise nature of the hierarchy between individual apical membrane complex components and $G\beta\gamma$ subunits remains to be elucidated.

Sensory organ precursor cells

A contrasting example of heterotrimeric G-protein signaling in the context of spindle positioning is found in *Drosophila* sensory organ precursor (SOP) cells (fig. 7B). Parts of the peripheral nervous system in *Drosophila* are derived from SOP cells [275], and involve $G\alpha i$ - and $G\beta\gamma$ -subunit control of spindle positioning and cell-fate determinant localization [267]. Spindle orientation and cell-fate determinants in neuroblasts are oriented around an apical-basolateral axis, whereas SOP cells exhibit planar polarity along the anterior-posterior axis. In this system, the pI (primary precursor) cell divides asymmetrically into an anterior pIIa, which inherits cell-fate determinants such as Numb and PON, and a posterior pIIb [276, 277]. In contrast to neuroblasts, SOP cells have two counteracting complexes, (i) $G\alpha i$ /Pins towards the anterior and (ii) DmPar6/DaPKC/Baz towards the posterior [278]. Furthermore, Inscuteable is not expressed in pI cells [279], and its ectopic expression reverses polarity, bringing Bazooka into the anterior complex with Pins, such that cell-fate determinants such as Numb mislocalize to the posterior [280]. Division of SOP cells is asymmetric only in the context of cell-fate determinant distribution to daughter cells, as the cells and spindle sizes are equal. Asymmetric division only occurs in these cells during simultaneous loss of components from each of the $G\alpha i$ /Pins and DaPKC/Baz/DmPar6 complexes, a situa-

tion mimicked by loss of $G\beta$ subunit function [278]. Finally, in another contrast to the neuroblast, expression of the constitutively-active $G\alpha i^{Q205L}$ mutant perturbs spindle orientation in SOP cells [267], suggesting that there may be some GPCR-mediated signal in this context (i.e. generation of active $G\alpha i \cdot GTP$). To this end, the Frizzled receptor, proposed to be a de facto GPCR [281], modulates spindle rotation and polarity in the pI to pIIa/b division [276, 282].

Asymmetric cell division in *C. elegans*

In *Caenorhabditis elegans* embryos, the first division is asymmetric (fig. 7C) [283–285]. The zygote divides into a larger AB anterior cell and a smaller P1 posterior cell. Polarity is established by the sperm at fertilization [285], and as with *Drosophila* neuroblasts, spindle positioning and the expression and localization of cell-fate determinants are coordinated by a complex array of proteins. At the top of the hierarchy are the PAR (Partitioning defective) proteins, a group of structurally unrelated proteins isolated in a screen for regulators of asymmetric cell division [286]. There are six PAR proteins, which, in combination with atypical protein kinase C-3 (aPKC-3) and the small G-protein Cdc42, establish the anterior-posterior axis of cell polarity. PAR-3/-6 and aPKC-3 localize to the anterior cortex [287–289], while PAR-1/-2 define the posterior end [290, 291]. Mutation of any of the PAR proteins or aPKC results in symmetric division [283, 286, 289, 292].

As previously discussed, heterotrimeric G-protein subunits and modulators such as Pins are directly involved in establishing cell polarity in *Drosophila* ACD systems. In contrast, in the *C. elegans* zygote, G-protein subunits, GoLoco proteins and other modulators appear to act downstream of polarity determinants (such as aPKC-3 and the PAR proteins) in positioning the mitotic spindle and regulating pulling forces on this spindle during the first zygotic division. There are four G-protein subunits relevant to asymmetric cell division in *C. elegans*: GPA-16 and GOA-1 are $G\alpha$ subunits (most similar to mammalian $G\alpha i$ and $G\alpha o$, respectively) and GPB-1 and GPC-2 are $G\beta$ and $G\gamma$ subunits, respectively. Concurrent inactivation of GOA-1 and GPA-16 leads to a loss of asymmetric pulling force (fig. 8), causing daughter cells to be the same size [291]; loss-of-function mutations or RNAi of either *gpb-1* or *gpc-2* results in improper centrosome rotation, leading to spindle misorientation [291, 293]. The hierarchy of PAR proteins being upstream of G-protein subunit involvement is confirmed by the lack of any defect in the localization of PAR proteins or cell-fate determinants in response to reduction of $G\alpha$ expression [197, 291].

A functional genomic screen by Gönczy and colleagues identified the single GoLoco motif-containing proteins

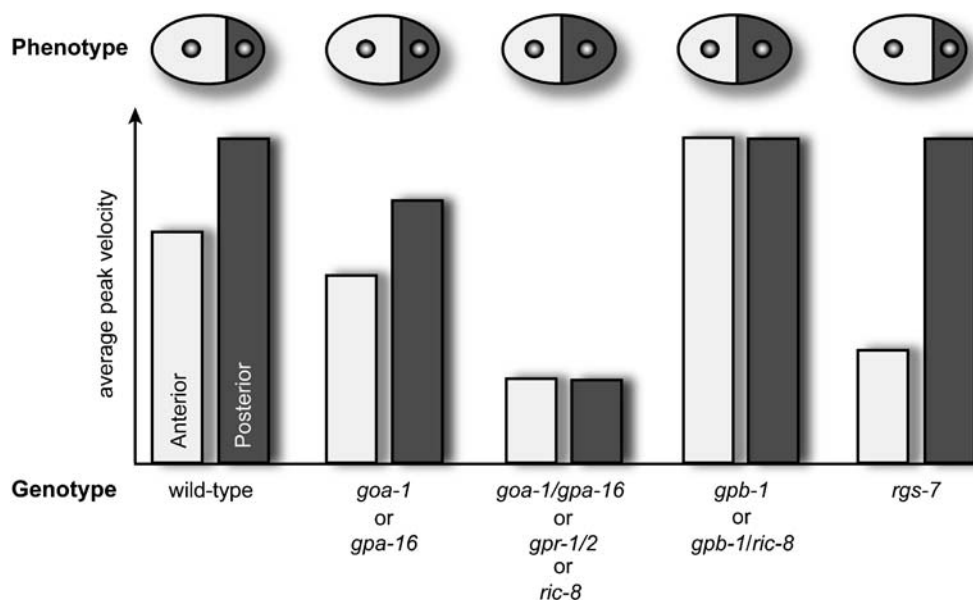

Figure 8. Phenotypes and relative spindle pulling forces of *C. elegans* embryos in various genetic backgrounds. In wild-type embryos, posterior enrichment of $G\alpha$ and GPR-1/2 are associated with stronger posterior pulling forces resulting in asymmetric division (light grey, AB daughter cell; dark grey, P1 daughter cell). Loss-of-function mutation or RNAi of either *goa-1* or *gpa-16* $G\alpha$ subunit leads to reduction in force magnitude and force asymmetry, but no change in the overall asymmetry of the cell division [294]. Mutation or RNAi of both G-protein subunits, both GoLoco motif proteins *gpr-1/2* or the receptor-independent $G\alpha$ GEF *ric-8* causes symmetric division due to loss or mislocalization of pulling force generators. Simultaneous loss of *ric-8* and *gpb-1* leads to an enhancement of anterior pulling forces indistinguishable from *gpb-1* RNAi alone [294]. In contrast, *rgs-7* mutants display reduced anterior pulling forces, resulting in exaggerated asymmetry and a smaller P1 cell [305]. In all cases, pulling forces were determined by laser ablation of central mitotic spindles and direct measurement of resultant peak velocities of spindle poles.

GPR-1 and GPR-2 (fig. 5) as crucial for asymmetric cell division [197]. We and others have shown that the single GoLoco motif of GPR-1 acts as a GDI towards the *C. elegans* $G\alpha$ subunit GOA-1 [198, 294]. As GPR-1 and GPR-2 are nearly identical at their protein and nucleotide sequence levels, a single interfering RNA is able to knock down expression of both proteins; RNAi-mediated knock down of *gpr-1/2* results in a loss of asymmetric division, and mislocalization of spindles in two-cell embryos – a phenotype identical to that of concomitant *goa-1* and *gpa-16* RNAi [197]. GPR-1/2 proteins colocalize and interact with the $G\alpha$ subunit GOA-1 to regulate *C. elegans* asymmetric division [197, 199, 291]. RNAi of either *gpr-1/2* or *gpa-16/goa-1* was found to significantly reduce both anterior and posterior spindle-pole peak migration velocities in laser-mediated spindle-severing experiments (fig. 8), whereas wild-type embryos display a 40% higher peak velocity at the posterior spindle pole [197]. This greater net posterior pulling force in the wild-type embryo correlates well with (i) the prediction by Grill et al. of a ~50% enrichment of force generators in the posterior, as obtained in ultraviolet (UV) laser-induced centrosome disintegration studies [295] and (ii) the higher levels of GPR-1/2 seen at the posterior cortex [197]. Collectively, these findings suggest that the $G\alpha$ GDI proteins GPR-1/2 and their target $G\alpha$ subunits either directly modulate the actions of astral microtubule force generators or are the

force generators themselves; one current model of how these proteins might act during asymmetric cell division, in conjunction with other newly discovered G-protein regulators, is discussed below.

Involvement of heterotrimeric G-proteins in mammalian cell division

In contrast to the considerable wealth of studies in *C. elegans* and *D. melanogaster*, information regarding the role of heterotrimeric G-proteins in mammalian cell division is relative scarce. There are, however, mammalian orthologues to the G-protein subunits, GoLoco motif proteins and even cell-fate determinants with cognate roles in asymmetric cell division in vertebrates (e.g. Numb; [296, 297]). For example, GPSM2 (LGN) [208] has 47% overall sequence identity with *Drosophila* Pins [274], displaying 67 and 32% identity to fly Pins in the TPR and GoLoco repeat regions, respectively. Several studies have demonstrated subcellular translocation of GPSM2 during cell division, including movement from the cytoplasm to the midbody [298], the spindle pole [213] or the cortex [268]. Either ectopic expression or RNAi-mediated knockdown of GPSM2 results in spindle disorganization and abnormal chromosome segregation [213], leading to cell cycle disruption [268]. Detailed studies by Du and colleagues have revealed that GPSM2

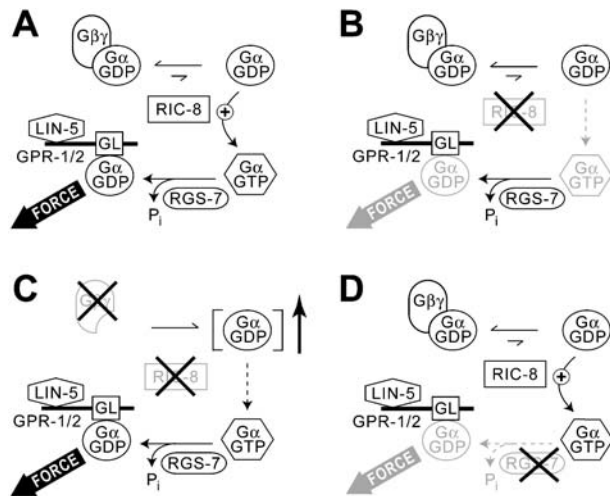

Figure 9. Working model of $G\alpha$ activation during asymmetric cell division of *C. elegans* embryos. (A) In the wild-type embryo, RIC-8 GEF activity generates $G\alpha$ -GTP. (It is still unclear whether *C. elegans* RIC-8 can act directly on $G\beta\gamma$ -complexed $G\alpha$ -GDP, since rat Ric-8A has been shown, at least in vitro, to act only on free $G\alpha$ subunits [193]. An alternate possibility is that a distinct pool of free $G\alpha$ exists or is generated from $G\alpha$ -GDP/ $G\beta\gamma$ heterotrimers by some as-yet unidentified player in this pathway.) The intrinsic GT-Pase activity of $G\alpha$ -GTP, possibly accelerated by RGS-7 GAP activity, then generates $G\alpha$ -GDP that binds the GoLoco motif of GPR-1/2 (the latter protein in complex with its critical co-factor LIN-5; [199]). The GPR-1/2/ $G\alpha$ -GDP complex is presumed to either modulate the (as-yet undefined) astral microtubule force generator or directly generate force (black arrow). (B) In the absence of RIC-8 activity, $G\alpha$ -GTP levels are reduced, resulting in significantly lower levels of $G\alpha$ -GDP required to form the GPR-1/2/ $G\alpha$ -GDP complex. This is consistent with the observations of reduced GPR-1/2/ $G\alpha$ -GDP co-immunoprecipitation from *ric-8* (*md1909+RNAi*) *C. elegans* embryos [294]. (C) Combining the elimination of RIC-8 activity with RNAi-mediated knockdown of *gpb-1* ($G\beta$) is observed to restore the levels of GPR-1/2/ $G\alpha$ -GDP complex [294] and the magnitude of force applied to the spindle poles (fig. 8). $G\alpha$ -GDP freed from its normal heterotrimeric state has a higher spontaneous nucleotide exchange rate [5] and therefore, in this model, can cycle through the GTP-bound state, GTP hydrolysis and GPR-1/2 interaction (or can directly bind to GPR-1/2; not shown). (D) In this model, loss of RGS-7 GAP activity leads to slower conversion of $G\alpha$ -GTP to the $G\alpha$ -GDP form required for the GPR-1/2/ $G\alpha$ -GDP complex. This is consistent with the reduced anterior forces observed in loss-of-function *rgs-7* mutants, although it is not known if RGS-7 is restricted in expression to the anterior cortex [305].

localizes to the spindle poles during cell division where it binds to the nuclear mitotic apparatus protein (NuMA) [213]. NuMA is involved in microtubule stabilization and organization at spindle poles; it is believed to nucleate microtubule bundles as a multimeric complex [299]. NuMA association with microtubules occurs through a C-terminal domain, and GPSM2 binds directly to NuMA through an overlapping region of the same C-terminal domain. Thus GPSM2 affects spindle organization by limiting the amount of NuMA available for microtubule nucleation [210].

The GoLoco domains of GPSM2 display GDI activity on $G\alpha_{i1}$ and $G\alpha_o$, although binding affinity and GDI activity towards $G\alpha_o$ are an order of magnitude lower than towards $G\alpha_{i1}$ [209]. During cell division, GPSM2 localizes to the cell cortex, and the multiple GoLoco motif C-terminus is sufficient for this distribution [268] as is the case with the *Drosophila* homologue Pins [300]. It is likely that binding to $G\alpha$ subunits directs this membrane association, as ectopic expression of $G\alpha_o$ is reported to induce cortical localization of GPSM2 in non-dividing cells [268]. Another closely-related TPR- and GoLoco motif-containing protein present in metazoans is GPSM1 (AGS3); however, this protein has not been functionally analyzed with respect to its involvement in cell division to the same degree as GPSM2.

The usual suspects: GEF, GDI and GAP activities in asymmetric cell division

The discovery of $G\alpha$ subunits as key constituents in the protein machinery of asymmetric cell division has led to the proposal that heterotrimeric G-protein signaling in ACD could occur in the absence of any canonical GPCR-mediated signal [200]. This is supported by circumstantial evidence that the in vitro culturing of fly neuroblasts, which effectively eliminates external signaling cues, does not perturb spindle positioning or segregation of cell-fate determinants [301, 302]. In a corresponding fashion, the shell surrounding *C. elegans* embryos makes it improbable that the first zygotic division receives or requires any extrinsic cue.

RIC-8 might act in lieu of receptor-mediated GEF activity in *C. elegans* embryo division. As mentioned previously, mammalian Ric-8A is a receptor-independent GEF for $G\alpha_o$ and $G\alpha_q$ subunits in vitro [193]. In *C. elegans*, *ric-8* mutations cause defects in spindle orientation and lead to a frequency of embryonic lethality of 15–30% [303]. *ric-8* mutant lethality can be augmented to 100% with concomitant mutation to *goa-1*, suggesting that these gene products might act in the same pathway [303]. Indeed, in collaboration with Pierre Gönczy, we have shown that *C. elegans* RIC-8 interacts with GOA-1 (selectively with its GDP-bound form) and acts as a GEF for GOA-1 as observed by RIC-8-dependent increases in GTP γ S binding and steady-state GDP hydrolysis [294]. RNAi-mediated elimination of RIC-8 function (in a background of loss-of-function *ric-8* alleles) leads to reduced anterior and posterior pulling forces on the mitotic spindle of the one-cell zygote [294] – a phenotype identical to that of concomitant *goa-1* and *gpa-16* RNAi and of *gpr-1/2* RNAi (fig. 8). Elimination of RIC-8 function also reduces the level of GOA-1-GDP/GPR-1/2 complex observed in *C. elegans* embryonic extracts [294]; however, concomitant inactivation of $G\beta\gamma$ (via *gpb-1* RNAi) along with *ric-8* RNAi restores levels of the GOA-1-GDP/GPR-

1/2 complex as well as restoring robust anterior and posterior pulling forces on the mitotic spindle (fig. 8).

As a whole, these genetic and biochemical observations have led to the idea that RIC-8 functions in cell division upstream of GPR-1/2 – a function that somehow counteracts the entrapment of $G\alpha$ -GDP in the $G\alpha\beta\gamma$ heterotrimer and leads to production of a GOA-1-GDP/GPR-1/2 complex, as illustrated in the working model of figure 9. This model considers the GOA-1-GDP/GPR-1/2 complex as the active species in signaling to pulling force generation. It is important to note that some of our findings regarding *C. elegans* RIC-8 have been independently confirmed by Gotta and co-workers [304], although this group interprets the involvement of RIC-8 GEF activity in asymmetric cell division as evidence that $G\alpha$ -GTP is the active species in force generation required for this process.

Remarkably, as in GPCR-stimulated heterotrimeric G-protein signaling, RGS proteins are emerging as critical regulators of $G\alpha$ action in cell division. For example, Hess and colleagues recently reported that the *C. elegans* RGS-7 protein can act to accelerate GTP hydrolysis by GOA-1 [305]; loss of RGS-7 function leads to hyperasymmetric spindle movements in the one-cell zygote, resulting from a decreased anterior spindle pulling force (summarized in fig. 8). In the working model of $G\alpha$ involvement in pulling force generation (fig. 9), the findings of Hess et al. could be explained by RGS-7 acting selectively at the anterior cortex to accelerate conversion of $G\alpha$ -GTP to $G\alpha$ -GDP for interaction with GPR-1/2; loss of RGS-7 GAP activity would therefore lead to less anterior GOA-1-GDP/GPR-1/2 complex and less force generation from the anterior cortex (fig. 9D). Unfortunately, the initial studies by Hess and colleagues did not include an examination of the distribution of endogenous RGS-7 protein in the dividing one-cell zygote, and thus future studies are required to ascertain whether RGS-7 function is indeed restricted to the anterior cortex.

Intriguingly, recent evidence supports a similar role for RGS proteins in mammalian cell division. With our colleagues Josef Penninger and Tony D'Souza, we generated *Rgs14* knockout mice; lack of RGS14 expression in the mouse zygote leads to an early embryonic lethality, specifically at the first zygotic division [306]. RGS14 was found to be one of the earliest proteins expressed by the mouse embryonic genome immediately prior to the first division; the protein was observed to co-localize with microtubules forming the anastral mitotic apparatus of the dividing one-cell zygote. Immunofluorescence microscopy of mouse embryos lacking RGS14 revealed misaligned chromatin and a dearth of microtubule organization or diffuse tubulin and DNA staining, the latter phenotype suggestive of chromosomal fragmentation. In all mammalian cell types examined, RGS14 segregated to the mitotic spindle and centrosomes during mitosis [306]; alteration of RGS14 levels in exponentially proliferating

cells, either by RNAi-mediated knockdown or constitutive expression, was found to be deleterious to continued cell proliferation – a phenomenon very similar to that observed by Du and colleagues with GPSM2/LGN overexpression or knockdown [210, 213]. We have also recently reported that RGS14 is a microtubule-associated protein and its depletion from mitotic cell extracts prevents aster formation normally catalyzed by the addition of ATP and taxol [307]. Our findings implicate RGS14 (and its $G\alpha$ targets) as critical players in cell division processes from the very first zygotic division and suggest that heterotrimeric G-protein regulation of microtubules may be a conserved mechanism by which metazoans control spindle organization and force generation during chromosomal DNA segregation into daughter cells.

Unanswered questions and future directions

Many questions remain unanswered as far as the detailed mechanism of G-protein regulation of spindle pulling forces during cell division. It has been proposed that tubulin may be a direct downstream target of G-proteins in the context of cell division [134]. This is supported by evidence that both $G\alpha$ and $G\beta\gamma$ subunits can regulate tubulin assembly and microtubule dynamics [308–313]. In particular, GTP-bound $G\alpha_{i1}$ can bind directly to tubulin, transactivate its intrinsic GTPase activity and modulate microtubule assembly [308, 310]. Using a novel form of microscopy, Labbé and colleagues have demonstrated that microtubule residence at the cell cortex is significantly longer on the anterior versus posterior side of the *C. elegans* early embryo [314]. In contrast, upon RNAi-mediated elimination of *goa-1* and *gpa-16* expression, microtubule residence time is equivalent at the anterior and posterior cortex (i.e. both equal to that of the posterior cortex in wild-type embryos), thus reinforcing the evidence that $G\alpha$ subunits are responsible for asymmetric force generation. It is of note that microtubule residence time was not changed in general [314], indicating that force generation does not involve changes in microtubule cortical dynamics but, more likely, in the machinery regulating microtubule polymerization and depolymerization.

Whereas the GTP-bound form of $G\alpha$ subunits is the active species in canonical GPCR signaling pathways, it remains to be proven if this is the case in asymmetric cell division. With the potential exception of Rap1GAP [204], GoLoco motif-containing proteins such as Pins, GPSM2 and GPR-1/2 only bind to the GDP-bound form of $G\alpha$ subunits. Thus it remains to be established if the active species responsible for controlling spindle pulling forces is $G\alpha$ -GDP, $G\alpha$ -GTP, GoLoco-bound $G\alpha$ -GDP (as suggested in our working model; fig. 9), or something else entirely. In addition, it is unclear how the $G\alpha\beta\gamma$ het-

erotrimer is dissociated to allow Ric-8 and GoLoco proteins unfettered access to the GDP-bound $G\alpha$ subunit. In *in vitro* studies with rat Ric-8A, Tall and colleagues have suggested that Ric-8 GEF activity cannot operate on $G\beta\gamma$ -complexed $G\alpha$ -GDP [193]; perhaps *C. elegans* RIC-8 does not share this restriction or a cellular context with appropriately membrane-targeted G-protein subunits is required to observe GEF activity on the heterotrimer. Some have proposed that GoLoco motif proteins can disrupt $G\alpha\beta\gamma$ heterotrimeric complexes [199, 267, 315]; however, in electrophysiological studies of the influence of GoLoco motif peptides on GPCR coupling to $G\beta\gamma$ -gated GIRK potassium channels, we have been unable to observe GoLoco motif-mediated activation of G_i -heterotrimers in a fully integrated cellular context [316]. Moreover, our recent evidence that RIC-8 acts upstream of GPR-1/2 in the cycle underlying GOA-1-mediated spindle pulling force generation ([294]; fig. 9) disavows this possibility. Other proteins are clearly involved in spindle dynamics and may be directly engaged in generating $G\alpha$ free from $G\beta\gamma$. LIN-5 has been identified as a binding partner of GPR-1/2 in *C. elegans* (fig. 9), and disruption of *lin-5* results in a symmetric zygotic division phenotype akin to that of *gpr-1/2* or *gpa-16/goa-1* RNAi [198, 199]. LIN-5 is a coiled-coil protein that localizes GPR-1/2 to the posterior cortex and is thus paramount for correct pulling force distribution. Another protein, LET-99, appears to counteract the $G\alpha$ /GPR-1/2 pathway, such that loss-of-function *let-99* mutations result in increased pulling forces and a hyperactive rocking motion during spindle rotation [317]. The apparent multiple levels of control and complexity of this system are not surprising in light of the essential nature of correct asymmetric division for embryo viability. Further studies will be required to identify the precise role of each of the heterotrimeric subunits in cell division, delineate the complex interactions between polarity cues and spindle positioning, and identify the mechanism by which heterotrimeric G-proteins regulate pulling forces.

Acknowledgements. We thank Christopher A. Johnston for critical appraisal of this review. C.R.M. and F.S.W. are postdoctoral fellows of the Natural Sciences and Engineering Council of Canada and the American Heart Association, respectively. R.J.K. acknowledges predoctoral fellowship support from the NIMH F30 MH64319. Work in the Siderovski laboratory is funded by U.S. National Institutes of Health grants GM062338 and GM065533.

- 1 Evanko D. S., Thiyagarajan M. M., Siderovski D. P. and Wedegaertner P. B. (2001) Gbeta gamma isoforms selectively rescue plasma membrane localization and palmitoylation of mutant Galphas and Galphaq. *J. Biol. Chem.* **276**: 23945–23953
- 2 Chen C. A. and Manning D. R. (2001) Regulation of G proteins by covalent modification. *Oncogene* **20**: 1643–1652

- 3 Robillard L., Ethier N., Lachance M. and Hebert T. E. (2000) Gbetagamma subunit combinations differentially modulate receptor and effector coupling *in vivo*. *Cell Signal.* **12**: 673–682
- 4 Brandt D. R. and Ross E. M. (1985) GTPase activity of the stimulatory GTP-binding regulatory protein of adenylate cyclase, Gs. Accumulation and turnover of enzyme-nucleotide intermediates. *J. Biol. Chem.* **260**: 266–272
- 5 Higashijima T., Ferguson K. M., Sternweis P. C., Smigel M. D. and Gilman A. G. (1987) Effects of Mg^{2+} and the beta gamma-subunit complex on the interactions of guanine nucleotides with G proteins. *J. Biol. Chem.* **262**: 762–766
- 6 Wall M. A., Posner B. A. and Sprang S. R. (1998) Structural basis of activity and subunit recognition in G protein heterotrimers. *Structure* **6**: 1169–1183
- 7 Ford C. E., Skiba N. P., Bae H., Daaka Y., Reuveny E., Shekter L. R. et al. (1998) Molecular basis for interactions of G protein betagamma subunits with effectors. *Science* **280**: 1271–1274
- 8 Li Y., Sternweis P. M., Charnecki S., Smith T. F., Gilman A. G., Neer E. J. et al. (1998) Sites for Galpha binding on the G protein beta subunit overlap with sites for regulation of phospholipase Cbeta and adenylyl cyclase. *J Biol Chem* **273**: 16265–16272
- 9 Simon M. I., Strathmann M. P. and Gautam N. (1991) Diversity of G proteins in signal transduction. *Science* **252**: 802–808
- 10 Nurnberg B., Gudermann T. and Schultz G. (1995) Receptors and G proteins as primary components of transmembrane signal transduction. Part 2. G proteins: structure and function. *J. Mol. Med.* **73**: 123–132
- 11 Wedegaertner P. B., Wilson P. T. and Bourne H. R. (1995) Lipid modifications of trimeric G proteins. *J. Biol. Chem.* **270**: 503–506
- 12 Peitzsch R. M. and McLaughlin S. (1993) Binding of acylated peptides and fatty acids to phospholipid vesicles: pertinence to myristoylated proteins. *Biochemistry* **32**: 10436–10443
- 13 Grassie M. A., McCallum J. F., Guzzi F., Magee A. I., Milligan G. and Parenti M. (1994) The palmitoylation status of the G-protein G(o)1 alpha regulates its activity of interaction with the plasma membrane. *Biochem. J.* **302**: 913–920
- 14 Galbiati F., Guzzi F., Magee A. I., Milligan G. and Parenti M. (1994) N-terminal fatty acylation of the alpha-subunit of the G-protein Gi1: only the myristoylated protein is a substrate for palmitoylation. *Biochem. J.* **303**: 697–700
- 15 Mumby S. M., Kleuss C. and Gilman A. G. (1994) Receptor regulation of G-protein palmitoylation. *Proc. Natl. Acad. Sci. USA* **91**: 2800–2804
- 16 Kisselev O., Ermolaeva M. and Gautam N. (1995) Efficient interaction with a receptor requires a specific type of prenyl group on the G protein gamma subunit. *J. Biol. Chem.* **270**: 25356–25358
- 17 Moffett S., Brown D. A. and Linder M. E. (2000) Lipid-dependent targeting of G proteins into rafts. *J. Biol. Chem.* **275**: 2191–2198
- 18 Myung C. S., Yasuda H., Liu W. W., Harden T. K. and Garrison J. C. (1999) Role of isoprenoid lipids on the heterotrimeric G protein gamma subunit in determining effector activation. *J. Biol. Chem.* **274**: 16595–16603
- 19 Dohlman H. G., Song J., Ma D., Courchesne W. E. and Thorner J. (1996) Sst2, a negative regulator of pheromone signaling in the yeast *Saccharomyces cerevisiae*: expression, localization and genetic interaction and physical association with Gpa1 (the G-protein alpha subunit). *Mol. Cell. Biol.* **16**: 5194–5209
- 20 Fletcher J. E., Lindorfer M. A., DeFilippo J. M., Yasuda H., Guilford M. and Garrison J. C. (1998) The G protein beta5 subunit interacts selectively with the Gq alpha subunit. *J. Biol. Chem.* **273**: 636–644

- 21 Clapham D. E. and Neer E. J. (1997) G protein beta gamma subunits. *Annu. Rev. Pharmacol. Toxicol.* **37**: 167–203
- 22 Huang L., Shanker Y. G., Dubauskaite J., Zheng J. Z., Yan W., Rosenzweig S. et al. (1999) Ggamma13 colocalizes with gustducin in taste receptor cells and mediates IP3 responses to bitter denatonium. *Nat. Neurosci.* **2**: 1055–1062
- 23 Ray K., Kunsch C., Bonner L. M. and Robishaw J. D. (1995) Isolation of cDNA clones encoding eight different human G protein gamma subunits, including three novel forms designated the gamma 4, gamma 10, and gamma 11 subunits. *J. Biol. Chem.* **270**: 21765–21771
- 24 Jones M. B., Siderovski D. P. and Hooks S. B. (2004) The Gbg dimer as a novel source of selectivity in G-protein signaling: GGL-ing at convention. *Mol. Interv.* **4**: 200–214
- 25 Schmidt C. J., Thomas T. C., Levine M. A. and Neer E. J. (1992) Specificity of G protein beta and gamma subunit interactions. *J. Biol. Chem.* **267**: 13807–13810
- 26 Muller S., Straub A., Schroder S., Bauer P. H. and Lohse M. J. (1996) Interactions of phosducin with defined G protein beta gamma-subunits. *J. Biol. Chem.* **271**: 11781–11786
- 27 Wolfe J. T., Wang H., Howard J., Garrison J. C. and Barrett P. Q. (2003) T-type calcium channel regulation by specific G-protein betagamma subunits. *Nature* **424**: 209–213
- 28 Kleuss C., Scherubl H., Hescheler J., Schultz G. and Wittig B. (1993) Selectivity in signal transduction determined by gamma subunits of heterotrimeric G proteins. *Science* **259**: 832–834
- 29 Wang Q., Mullah B., Hansen C., Asundi J. and Robishaw J. D. (1997) Ribozyme-mediated suppression of the G protein gamma7 subunit suggests a role in hormone regulation of adenylyl cyclase activity. *J. Biol. Chem.* **272**: 26040–26048
- 30 Wang Q., Mullah B. K. and Robishaw J. D. (1999) Ribozyme approach identifies a functional association between the G protein beta1 gamma7 subunits in the beta-adrenergic receptor signaling pathway. *J. Biol. Chem.* **274**: 17365–17371
- 31 Schwindinger W. F., Betz K. S., Giger K. E., Sabol A., Bronson S. K. and Robishaw J. D. (2003) Loss of G protein gamma 7 alters behavior and reduces striatal alpha(olf) level and cAMP production. *J. Biol. Chem.* **278**: 6575–6579
- 32 Wang Q., Jolly J. P., Surmeier J. D., Mullah B. M., Lidow M. S., Bergson C. M. et al. (2001) Differential dependence of the D1 and D5 dopamine receptors on the G protein gamma 7 subunit for activation of adenylyl cyclase. *J. Biol. Chem.* **276**: 39386–39393
- 33 Sprang S. R. (1997) G protein mechanisms: insights from structural analysis. *Annu. Rev. of Biochem.* **66**: 639–678
- 34 Sondek J., Lambright D. G., Noel J. P., Hamm H. E. and Sigler P. B. (1994) GTPase mechanism of Gproteins from the 1.7-A crystal structure of transducin alpha-GDP-AIF-4. *Nature* **372**: 276–279
- 35 Lambright D. G., Noel J. P., Hamm H. E. and Sigler P. B. (1994) Structural determinants for activation of the alpha-subunit of a heterotrimeric G protein. *Nature* **369**: 621–628
- 36 Lambright D. G., Sondek J., Bohm A., Skiba N. P., Hamm H. E. and Sigler P. B. (1996) The 2.0 A crystal structure of a heterotrimeric G protein. *Nature* **379**: 311–319
- 37 Tesmer J. J., Berman D. M., Gilman A. G. and Sprang S. R. (1997) Structure of RGS4 bound to AIF4-activated G(i alpha1): stabilization of the transition state for GTP hydrolysis. *Cell* **89**: 251–261
- 38 Coleman D. E., Berghuis A. M., Lee E., Linder M. E., Gilman A. G. and Sprang S. R. (1994) Structures of active conformations of Gi alpha 1 and the mechanism of GTP hydrolysis. *Science* **265**: 1405–1412
- 39 Sternweis P. C. and Gilman A. G. (1982) Aluminum: a requirement for activation of the regulatory component of adenylyl cyclase by fluoride. *Proc. Natl. Acad. Sci. USA* **79**: 4888–4891
- 40 Apanovitch D. M., Slep K. C., Sigler P. B. and Dohlman H. G. (1998) Sst2 is a GTPase-activating protein for Gpa1: purification and characterization of a cognate RGS-Galpa protein pair in yeast. *Biochemistry* **37**: 4815–4822
- 41 Berman D. M., Kozasa T. and Gilman A. G. (1996) The GTPase-activating protein RGS4 stabilizes the transition state for nucleotide hydrolysis. *J. Biol. Chem.* **271**: 27209–27212
- 42 Graziano M. P. and Gilman A. G. (1989) Synthesis in *Escherichia coli* of GTPase-deficient mutants of Gs alpha. *J. Biol. Chem.* **264**: 15475–15482
- 43 Traut T. W. (1994) The functions and consensus motifs of nine types of peptide segments that form different types of nucleotide-binding sites. *Eur. J. Biochem.* **222**: 9–19
- 44 Nassar N., Horn G., Herrmann C., Scherer A., McCormick F. and Wittinghofer A. (1995) The 2.2 A crystal structure of the Ras-binding domain of the serine/threonine kinase c-Raf1 in complex with Rap1A and a GTP analogue. *Nature* **375**: 554–560
- 45 Polekhina G., Thirup S., Kjeldgaard M., Nissen P., Lippmann C. and Nyborg J. (1996) Helix unwinding in the effector region of elongation factor EF-Tu-GDP. *Structure* **4**: 1141–1151
- 46 Tong L. A., de Vos A. M., Milburn M. V. and Kim S. H. (1991) Crystal structures at 2.2 A resolution of the catalytic domains of normal ras protein and an oncogenic mutant complexed with GDP. *J. Mol. Biol.* **217**: 503–516
- 47 Grishina G. and Berlot C. H. (1998) Mutations at the domain interface of GSalpa impair receptor-mediated activation by altering receptor and guanine nucleotide binding. *J. Biol. Chem.* **273**: 15053–15060
- 48 Noel J. P., Hamm H. E. and Sigler P. B. (1993) The 2.2 A crystal structure of transducin-alpha complexed with GTP gamma S. *Nature* **366**: 654–663
- 49 Wall M. A., Coleman D. E., Lee E., Iniguez-Lluhi J. A., Posner B. A., Gilman A. G. et al. (1995) The structure of the G protein heterotrimer G1alpha1beta1gamma2. *Cell* **83**: 1047–1058
- 50 Preininger A. M., Van Eps N., Yu N. J., Medkova M., Hubbell W. L. and Hamm H. E. (2003) The myristoylated amino terminus of Galpha(i)(1) plays a critical role in the structure and function of Galpha(i)(1) subunits in solution. *Biochemistry* **42**: 7931–7941
- 51 Neer E. J., Schmidt C. J., Nambudripad R. and Smith T. F. (1994) The ancient regulatory-protein family of WD-repeat proteins. *Nature* **371**: 297–300
- 52 Sondek J., Bohm A., Lambright D. G., Hamm H. E. and Sigler P. B. (1996) Crystal structure of a G-protein beta gamma dimer at 2.1A resolution. *Nature* **379**: 369–374
- 53 Yan K. and Gautam N. (1996) A domain on the G protein beta subunit interacts with both adenylyl cyclase 2 and the muscarinic atrial potassium channel. *J. Biol. Chem.* **271**: 17597–17600
- 54 Leberer E., Dignard D., Hougan L., Thomas D. Y. and Whiteway M. (1992) Dominant-negative mutants of a yeast G-protein beta subunit identify two functional regions involved in pheromone signalling. *EMBO J.* **11**: 4805–4813
- 55 Sutherland E. W. and Rall T. W. (1958) Fractionation and characterization of a cyclic adenine ribonucleotide formed by tissue particles. *J. Biol. Chem.* **232**: 1077–1091
- 56 Rall T. W., Sutherland E. W. and Berthet J. (1957) The relationship of epinephrine and glucagon to liver phosphorylase IV Effect of epinephrine and glucagon on the reactivation of phosphorylase in liver homogenates. *J. Biol. Chem.* **224**: 463–475
- 57 Ross E. M. and Gilman A. G. (1977) Resolution of some components of adenylyl cyclase necessary for catalytic activity. *J. Biol. Chem.* **252**: 6966–6969
- 58 Smith S. K. and Limbird L. E. (1982) Evidence that human platelet alpha-adrenergic receptors coupled to inhibition of

- adenylate cyclase are not associated with the subunit of adenylyl cyclase ADP-ribosylated by cholera toxin. *J. Biol. Chem.* **257**: 10471–10478
- 59 Hsia J. A., Moss J., Hewlett E. L. and Vaughan M. (1984) ADP-ribosylation of adenylyl cyclase by pertussis toxin. Effects on inhibitory agonist binding. *J. Biol. Chem.* **259**: 1086–1090
- 60 Hildebrandt J. D. and Birnbaumer L. (1983) Inhibitory regulation of adenylyl cyclase in the absence of stimulatory regulation. Requirements and kinetics of guanine nucleotide-induced inhibition of the cyc- S49 adenylyl cyclase. *J. Biol. Chem.* **258**: 13141–13147
- 61 Hildebrandt J. D., Sekura R. D., Codina J., Iyengar R., Manclark C. R. and Birnbaumer L. (1983) Stimulation and inhibition of adenylyl cyclases mediated by distinct regulatory proteins. *Nature* **302**: 706–709
- 62 Sunahara R. K. and Taussig R. (2002) Isoforms of mammalian adenylyl cyclase: multiplicities of signaling. *Mol. Interv.* **2**: 168–184
- 63 Hanoune J. and Defer N. (2001) Regulation and role of adenylyl cyclase isoforms. *Annu. Rev. Pharmacol. Toxicol.* **41**: 145–174
- 64 Buck L. B. (2000) The molecular architecture of odor and pheromone sensing in mammals. *Cell* **100**: 611–618
- 65 Margolskee R. F. (2002) Molecular mechanisms of bitter and sweet taste transduction. *J. Biol. Chem.* **277**: 1–4
- 66 Arshavsky V. Y., Lamb T. D. and Pugh E. N. Jr (2002) G proteins and phototransduction. *Annu. Rev. Physiol.* **64**: 153–187
- 67 Rhee S. G. (2001) Regulation of phosphoinositide-specific phospholipase C. *Annu. Rev. Biochem.* **70**: 281–312
- 68 Worthylake D. K., Rossman K. L. and Sodek J. (2000) Crystal structure of Rac1 in complex with the guanine nucleotide exchange region of Tiam1. *Nature* **408**: 682–688
- 69 Longenecker K. L., Lewis M. E., Chikumi H., Gutkind J. S. and Derewenda Z. S. (2001) Structure of the RGS-like domain from PDZ-RhoGEF: linking heterotrimeric G protein-coupled signaling to Rho GTPases. *Structure* **9**: 559–569
- 70 Fukuhara S., Murga C., Zohar M., Igishi T. and Gutkind J. S. (1999) A novel PDZ domain containing guanine nucleotide exchange factor links heterotrimeric G proteins to Rho. *J. Biol. Chem.* **274**: 5868–5879
- 71 Booden M. A., Siderovski D. P. and Der C. J. (2002) Leukemia-associated Rho guanine nucleotide exchange factor promotes G alpha q-coupled activation of RhoA. *Mol. Cell. Biol.* **22**: 4053–4061
- 72 Vogt S., Grosse R., Schultz G. and Offermanns S. (2003) Receptor-dependent RhoA activation in G12/G13-deficient cells: genetic evidence for an involvement of Gq/G11. *J. Biol. Chem.* **278**: 28743–28749
- 73 Kozasa T., Jiang X., Hart M. J., Sternweis P. M., Singer W. D., Gilman A. G. et al. (1998) p115 RhoGEF, a GTPase activating protein for Galpha12 and Galpha13. *Science* **280**: 2109–2111
- 74 Hart M. J., Jiang X., Kozasa T., Roscoe W., Singer W. D., Gilman A. G. et al. (1998) Direct stimulation of the guanine nucleotide exchange activity of p115 RhoGEF by Galpha13. *Science* **280**: 2112–2114
- 75 Zohn I. E., Klinger M., Karp X., Kirk H., Symons M., Chrzanowska-Wodnicka M. et al. (2000) G2A is an oncogenic G protein-coupled receptor. *Oncogene* **19**: 3866–3877
- 76 Whitehead I. P., Zohn I. E. and Der C. J. (2001) Rho GTPase-dependent transformation by G protein coupled receptors. *Oncogene* **20**: 1547–1555
- 77 Martin C. B., Mahon G. M., Klinger M. B., Kay R. J., Symons M., Der C. J. et al. (2001) The thrombin receptor, PAR-1, causes transformation by activation of Rho-mediated signaling pathways. *Oncogene* **20**: 1953–1963
- 78 Fukuhara S., Chikumi H. and Gutkind J. S. (2001) RGS-containing RhoGEFs: the missing link between transforming G proteins and Rho? *Oncogene* **20**: 1661–1668
- 79 Logothetis D. E., Kurachi Y., Galper J., Neer E. J. and Clapham D. E. (1987) The beta gamma subunits of GTP-binding proteins activate the muscarinic K⁺ channel in heart. *Nature* **325**: 321–326
- 80 Lei Q., Jones M. B., Talley E. M., Schrier A. D., McIntire W. E., Garrison J. C. et al. (2000) Activation and inhibition of G protein-coupled inwardly rectifying potassium (Kir3) channels by G protein beta gamma subunits. *Proc. Natl. Acad. Sci. USA* **97**: 9771–9776
- 81 Huang C. L., Slesinger P. A., Casey P. J., Jan Y. N. and Jan L. Y. (1995) Evidence that direct binding of G beta gamma to the GIRK1 G protein-gated inwardly rectifying K⁺ channel is important for channel activation. *Neuron* **15**: 1133–1143
- 82 Huang C. L., Jan Y. N. and Jan L. Y. (1997) Binding of the G protein betagamma subunit to multiple regions of G protein-gated inward-rectifying K⁺ channels. *FEBS Lett.* **405**: 291–298
- 83 Inanobe A., Morishige K. I., Takahashi N., Ito H., Yamada M., Takumi T. et al. (1995) G beta gamma directly binds to the carboxyl terminus of the G protein-gated muscarinic K⁺ channel, GIRK1. *Biochem. Biophys. Res. Commun.* **212**: 1022–1028
- 84 Kunkel M. T. and Peralta E. G. (1995) Identification of domains conferring G protein regulation on inward rectifier potassium channels. *Cell* **83**: 443–449
- 85 Doupnik C. A., Dessauer C. W., Slepak V. Z., Gilman A. G., Davidson N. and Lester H. A. (1996) Time resolved kinetics of direct G beta 1 gamma 2 interactions with the carboxyl terminus of Kir3.4 inward rectifier K⁺ channel subunits. *Neuropharmacology* **35**: 923–931
- 86 Dascal N. (1997) Signalling via the G protein-activated K⁺ channels. *Cell Signal.* **9**: 551–573
- 87 Mark M. D. and Herlitze S. (2000) G-protein mediated gating of inward-rectifier K⁺ channels. *Eur. J. Biochem.* **267**: 5830–5836
- 88 Kammermeier P. J., Ruiz-Velasco V. and Ikeda S. R. (2000) A voltage-independent calcium current inhibitory pathway activated by muscarinic agonists in rat sympathetic neurons requires both Galpha q/11 and Gbeta gamma. *J. Neurosci.* **20**: 5623–5629
- 89 Delmas P., Abogadie F. C., Buckley N. J. and Brown D. A. (2000) Calcium channel gating and modulation by transmitters depend on cellular compartmentalization. *Nat. Neurosci.* **3**: 670–678
- 90 Lu Q., AtKisson M. S., Jarvis S. E., Feng Z. P., Zamponi G. W. and Dunlap K. (2001) Syntaxin 1A supports voltage-dependent inhibition of alpha1B Ca²⁺ channels by Gbetagamma in chick sensory neurons. *J. Neurosci.* **21**: 2949–2957
- 91 Garcia D. E., Li B., Garcia-Ferreiro R. E., Hernandez-Ochoa E. O., Yan K., Gautam N. et al. (1998) G-protein beta-subunit specificity in the fast membrane-delimited inhibition of Ca²⁺ channels. *J. Neurosci.* **18**: 9163–9170
- 92 Furukawa T., Miura R., Mori Y., Strobeck M., Suzuki K., Ogihara Y. et al. (1998) Differential interactions of the C terminus and the cytoplasmic I-II loop of neuronal Ca²⁺ channels with G-protein alpha and beta gamma subunits. II. Evidence for direct binding. *J. Biol. Chem.* **273**: 17595–17603
- 93 Mirshahi T., Mittal V., Zhang H., Linder M. E. and Logothetis D. E. (2002) Distinct sites on G protein beta gamma subunits regulate different effector functions. *J. Biol. Chem.* **277**: 36345–36350
- 94 Yamauchi J., Nagao M., Kaziro Y. and Itoh H. (1997) Activation of p38 mitogen-activated protein kinase by signaling through G protein-coupled receptors. Involvement of Gbetagamma and Galphaq/11 subunits. *J. Biol. Chem.* **272**: 27771–27777

- 95 Coso O. A., Teramoto H., Simonds W. F. and Gutkind J. S. (1996) Signaling from G protein-coupled receptors to c-Jun kinase involves beta gamma subunits of heterotrimeric G proteins acting on a Ras and Rac1-dependent pathway. *J. Biol. Chem.* **271**: 3963–3966
- 96 Crespo P., Xu N., Simonds W. F. and Gutkind J. S. (1994) Ras-dependent activation of MAP kinase pathway mediated by G-protein beta/gamma subunits. *Nature* **369**: 418–420
- 97 Faure M., Voyno-Yasenetskaya T. A. and Bourne H. R. (1994) cAMP and beta/gamma subunits of heterotrimeric G proteins stimulate the mitogen-activated protein kinase pathway in COS-7 cells. *J. Biol. Chem.* **269**: 7851–7854
- 98 Stephens L. R., Eguinoa A., Erdjument-Bromage H., Lui M., Cooke F., Coadwell J. et al. (1997) The G beta gamma sensitivity of a PI3K is dependent upon a tightly associated adaptor, p101. *Cell* **89**: 105–114
- 99 Maier U., Babich A. and Nurnberg B. (1999) Roles of non-catalytic subunits in gbetagamma-induced activation of class I phosphoinositide 3-kinase isoforms beta and gamma. *J. Biol. Chem.* **274**: 29311–29317
- 100 Maier U., Babich A., Macrez N., Leopoldt D., Gierschik P., Illenberger D. et al. (2000) Gbeta 5gamma 2 is a highly selective activator of phospholipid-dependent enzymes. *J. Biol. Chem.* **275**: 13746–13754
- 101 Stephens L., Smrcka A., Cooke F. T., Jackson T. R., Sternweis P. C. and Hawkins P. T. (1994) A novel phosphoinositide 3 kinase activity in myeloid-derived cells is activated by G protein beta gamma subunits. *Cell* **77**: 83–93
- 102 Gao B. N. and Gilman A. G. (1991) Cloning and expression of a widely distributed (type IV) adenylyl cyclase. *Proc. Natl. Acad. Sci. USA* **88**: 10178–10182
- 103 Tang W. J. and Gilman A. G. (1991) Type-specific regulation of adenylyl cyclase by G protein beta gamma subunits. *Science* **254**: 1500–1503
- 104 Taussig R., Tang W. J., Hepler J. R. and Gilman A. G. (1994) Distinct patterns of bidirectional regulation of mammalian adenylyl cyclases. *J. Biol. Chem.* **269**: 6093–6100
- 105 Boyer J. L., Waldo G. L. and Harden T. K. (1992) Beta gamma-subunit activation of G-protein-regulated phospholipase C. *J. Biol. Chem.* **267**: 25451–25456
- 106 Wing M. R., Houston D., Kelley G. G., Der C. J., Siderovski D. P. and Harden T. K. (2001) Activation of phospholipase C-epsilon by heterotrimeric G protein betagamma-subunits. *J. Biol. Chem.* **276**: 48257–48261
- 107 Haga T., Haga K. and Kameyama K. (1994) G protein-coupled receptor kinases. *J. Neurochem.* **63**: 400–412
- 108 Pitcher J. A., Freedman N. J. and Lefkowitz R. J. (1998) G protein-coupled receptor kinases. *Annu. Rev. Biochem.* **67**: 653–692
- 109 Welch H. C., Coadwell W. J., Ellson C. D., Ferguson G. J., Andrews S. R., Erdjument-Bromage H. et al. (2002) P-Rex1, a PtdIns(3,4,5)P3- and Gbetagamma-regulated guanine-nucleotide exchange factor for Rac. *Cell* **108**: 809–821
- 110 Lodowski D. T., Pitcher J. A., Capel W. D., Lefkowitz R. J. and Tesmer J. J. (2003) Keeping G proteins at bay: a complex between G protein-coupled receptor kinase 2 and Gbetagamma. *Science* **300**: 1256–1262
- 111 Berstein G., Blank J. L., Jhon D. Y., Exton J. H., Rhee S. G. and Ross E. M. (1992) Phospholipase C-beta 1 is a GTPase-activating protein for Gq/11, its physiologic regulator. *Cell* **70**: 411–418
- 112 Siderovski D. P., Hessel A., Chung S., and Tyers M. (1996) A new family of regulators of G-protein-coupled receptors? *Curr. Biol.* **6**: 211–212
- 113 Koelle M. R. and Horvitz H. R. (1996) EGL-10 regulates G protein signaling in the *C. elegans* nervous system and shares a conserved domain with many mammalian proteins. *Cell* **84**: 115–125
- 114 Druey K. M., Blumer K. J., Kang V. H. and Kehrl J. H. (1996) Inhibition of G-protein-mediated MAP kinase activation by a new mammalian gene family. *Nature* **379**: 742–746
- 115 Neubig R. R. and Siderovski D. P. (2002) Regulators of G-protein signalling as new central nervous system drug targets. *Nat. Rev. Drug. Discov.* **1**: 187–197
- 116 Doupnik C. A., Davidson N., Lester H. A. and Kofuji P. (1997) RGS proteins reconstitute the rapid gating kinetics of gbetagamma-activated inwardly rectifying K⁺ channels. *Proc. Natl. Acad. Sci. USA* **94**: 10461–10466
- 117 Saitoh O., Kubo Y., Miyatani Y., Asano T. and Nakata H. (1997) RGS8 accelerates G-protein-mediated modulation of K⁺ currents. *Nature* **390**: 525–529
- 118 Buenemann M. and Hosey M. M. (1998) Regulators of G protein signaling (RGS) proteins constitutively activate Gbeta/gamma-gated potassium channels. *J. Biol. Chem.* **273**: 31186–31190
- 119 Chuang H.-H., Yu M., Jan Y. N. and Jan L. Y. (1998) Evidence that the nucleotide exchange and hydrolysis cycle of G proteins cause acute desensitization of G-protein gated inward rectifier K⁺ channels. *Proc. Natl. Acad. Sci. USA* **95**: 11727–11732
- 120 Herlitze S., Ruppersberg J. P. and Mark M. D. (1999) New roles for RGS2, 5 and 8 on the ratio-dependent modulation of recombinant GIRK channels expressed in *Xenopus* oocytes. *J. Physiol.* **517**: 341–352
- 121 Saitoh O., Kubo Y., Odagiri M., Ichikawa M., Kanato Y. and Sekine T. (1999) RGS7 and RGS8 differentially accelerate G Protein-mediated modulation of K⁺ currents. *J. Biol. Chem.* **274**: 9899–9904
- 122 Snow B. E., Krumins A. M., Brothers G. M., Lee S.-F., Wall M. A., Chung S. et al. (1998) A G protein gamma subunit-like domain shared between RGS11 and other RGS proteins specifies binding to Gbeta5 subunits. *Proc. Natl. Acad. Sci. USA* **95**: 13307–13312
- 123 Snow B. E., Betts L., Mangion J., Sondek J. and Siderovski D. P. (1999) Fidelity of G protein beta-subunit association by the G protein gamma-subunit-like domains of RGS6, RGS7, and RGS11. *Proc. Natl. Acad. Sci. USA* **96**: 6489–6494
- 124 Makino E. R., Handy J. W., Li T. and Arshavsky V. Y. (1999) The GTPase activating factor for transducin in rod photoreceptors is the complex between RGS9 and type 5 G protein beta subunit. *Proc. Natl. Acad. Sci. USA* **96**: 1947–1952
- 125 Levay K., Cabrera J. L., Satpaev D. K. and Slepak V. Z. (1999) Gbeta5 prevents the RGS7-Galpha-o interaction through binding to a distinct Ggamma-like domain found in RGS7 and other RGS proteins. *Proc. Natl. Acad. Sci. USA* **96**: 2503–2507
- 126 Hu G. and Wensel T. G. (2002) R9AP, a membrane anchor for the photoreceptor GTPase accelerating protein, RGS9-1. *Proc. Natl. Acad. Sci. USA* **99**: 9755–9760
- 127 Lishko P. V., Martemyanov K. A., Hopp J. A. and Arshavsky V. Y. (2002) Specific binding of RGS9-Gbeta 5L to protein anchor in photoreceptor membranes greatly enhances its catalytic activity. *J. Biol. Chem.* **277**: 24376–24381
- 128 Schiff M. L., Siderovski D. P., Jordan J. D., Brothers G., Snow B., De Vries L. et al. (2000) Tyrosine kinase-dependent recruitment of RGS12 to the N-type calcium channel. *Nature* **408**: 723–727
- 129 Snow B. E., Hall R. A., Krumins A. M., Brothers G. M., Bouchard D., Brothers C. A. et al. (1998) GTPase activating specificity of RGS12 and binding specificity of an alternatively spliced PDZ (PSD-95/Dlg/ZO-1) domain. *J. Biol. Chem.* **273**: 17749–17755
- 130 Ponting C. P. (1999) Raf-like Ras/Rap-binding domains in RGS12 and still life like signalling proteins. *J. Mol. Med.* **77**: 695–698
- 131 Traver S., Bidot C., Spassky N., Baltauss T., De Tand M. F., Thomas J. L. et al. (2000) RGS14 is a novel Rap effector that

- preferentially regulates the GTPase activity of galphao. *Biochem. J.* **350**: 19–29
- 132 Kimple R. J., De Vries L., Tronchere H., Behe C. I., Morris R. A., Farquhar M. G. et al. (2001) RGS12 and RGS14 GoLoco motifs are Galpha (i) interaction sites with guanine nucleotide dissociation inhibitor activity. *J. Biol. Chem.* **276**: 29275–29281
 - 133 Kimple R. J., Kimple M. E., Betts L., Sondek J. and Siderovski D. P. (2002) Structural determinants for GoLoco-induced inhibition of nucleotide release by Galpha subunits. *Nature* **416**: 878–881
 - 134 Willard F. S., Kimple R. J. and Siderovski D. P. (2004) Return of the GDI: the GoLoco motif in cell division. *Annu. Rev. Biochem.* **73**: 925–951
 - 135 Fukuhara S., Chikumi H. and Gutkind J. S. (2000) Leukemia-associated rho guanine nucleotide exchange factor (LARG) links heterotrimeric G proteins of the G(12) family to Rho [In Process Citation]. *FEBS Lett.* **485**: 183–188
 - 136 Ferguson S. S. (2001) Evolving concepts in G protein-coupled receptor endocytosis: the role in receptor desensitization and signaling. *Pharmacol. Rev.* **53**: 1–24
 - 137 Carman C. V., Parent J. L., Day P. W., Pronin A. N., Sternweis P. M., Wedegaertner P. B. et al. (1999) Selective regulation of Galpha(q/11) by an RGS domain in the G protein-coupled receptor kinase, GRK2. *J. Biol. Chem.* **274**: 34483–34492
 - 138 Dhami G. K., Dale L. B., Anborgh P. H., O'Connor-Halligan K. E., Sterne-Marr R. and Ferguson S. S. (2004) G Protein-coupled receptor kinase 2 regulator of G protein signaling homology domain binds to both metabotropic glutamate receptor 1a and Galphaq to attenuate signaling. *J. Biol. Chem.* **279**: 16614–16620
 - 139 Iacovelli L., Capobianco L., Iula M., Di Giorgi Gerevini V., Picascia A., Blahos J. et al. (2004) Regulation of mGlu4 metabotropic glutamate receptor signaling by type-2 G-protein coupled receptor kinase (GRK2). *Mol. Pharmacol.* **65**: 1103–1110
 - 140 Kohout T. A. and Lefkowitz R. J. (2003) Regulation of G protein-coupled receptor kinases and arrestins during receptor desensitization. *Mol. Pharmacol.* **63**: 9–18
 - 141 Lorenz K., Lohse M. J. and Quitterer U. (2003) Protein kinase C switches the Raf kinase inhibitor from Raf-1 to GRK-2. *Nature* **426**: 574–579
 - 142 Yeung K., Seitz T., Li S., Janosch P., McFerran B., Kaiser C. et al. (1999) Suppression of Raf-1 kinase activity and MAP kinase signalling by RKIP. *Nature* **401**: 173–177
 - 143 Spink K. E., Polakis P. and Weis W. I. (2000) Structural basis of the Axin-adenomatous polyposis coli interaction. *EMBO J.* **19**: 2270–2279
 - 144 Berridge M. J. (1987) Inositol trisphosphate and diacylglycerol: two interacting second messengers. *Annu. Rev. Biochem.* **56**: 159–193
 - 145 Saunders C. M., Larman M. G., Parrington J., Cox L. J., Roysse J., Blayney L. M. et al. (2002) PLC zeta: a sperm-specific trigger of Ca(2+) oscillations in eggs and embryo development. *Development* **129**: 3533–3544
 - 146 Smrcka A. V., Hepler J. R., Brown K. O. and Sternweis P. C. (1991) Regulation of polyphosphoinositide-specific phospholipase C activity by purified Gq. *Science* **251**: 804–807
 - 147 Taylor S. J., Chae H. Z., Rhee S. G. and Exton J. H. (1991) Activation of the beta 1 isozyme of phospholipase C by alpha subunits of the Gq class of G proteins. *Nature* **350**: 516–518
 - 148 Waldo G. L., Boyer J. L., Morris A. J. and Harden T. K. (1991) Purification of an AIF4- and G-protein beta gamma-subunit-regulated phospholipase C-activating protein. *J. Biol. Chem.* **266**: 14217–14225
 - 149 Wu D. Q., Lee C. H., Rhee S. G. and Simon M. I. (1992) Activation of phospholipase C by the alpha subunits of the Gq and G11 proteins in transfected Cos-7 cells. *J. Biol. Chem.* **267**: 1811–1817
 - 150 Blank J. L., Brattain K. A. and Exton J. H. (1992) Activation of cytosolic phosphoinositide phospholipase C by G-protein beta gamma subunits. *J. Biol. Chem.* **267**: 23069–23075
 - 151 Camps M., Carozzi A., Schnabel P., Scheer A., Parker P. J. and Gierschik P. (1992) Isozyme-selective stimulation of phospholipase C-beta 2 by G protein beta gamma-subunits. *Nature* **360**: 684–686
 - 152 Wahl M. I., Nishibe S., Suh P. G., Rhee S. G. and Carpenter G. (1989) Epidermal growth factor stimulates tyrosine phosphorylation of phospholipase C-II independently of receptor internalization and extracellular calcium. *Proc. Natl. Acad. Sci. USA* **86**: 1568–1572
 - 153 Meisenhelder J., Suh P. G., Rhee S. G. and Hunter T. (1989) Phospholipase C-gamma is a substrate for the PDGF and EGF receptor protein-tyrosine kinases in vivo and in vitro. *Cell* **57**: 1109–1122
 - 154 Rhee S. G. and Choi K. D. (1992) Regulation of inositol phospholipid-specific phospholipase C isozymes. *J. Biol. Chem.* **267**: 12393–12396
 - 155 Kim Y. H., Park T. J., Lee Y. H., Baek K. J., Suh P. G., Ryu S. H. et al. (1999) Phospholipase C-delta1 is activated by capacitative calcium entry that follows phospholipase C-beta activation upon bradykinin stimulation. *J. Biol. Chem.* **274**: 26127–26134
 - 156 Baek K. J., Kang S., Damron D. and Im M. (2001) Phospholipase Cdelta1 is a guanine nucleotide exchanging factor for transglutaminase II (Galpha h) and promotes alpha 1B-adrenoreceptor-mediated GTP binding and intracellular calcium release. *J. Biol. Chem.* **276**: 5591–5597
 - 157 Shibatohe M., Kariya K., Liao Y., Hu C. D., Watari Y., Goshima M. et al. (1998) Identification of PLC210, a *Caenorhabditis elegans* phospholipase C, as a putative effector of Ras. *J. Biol. Chem.* **273**: 6218–6222
 - 158 Kelley G. G., Reks S. E., Ondrako J. M. and Smrcka A. V. (2001) Phospholipase C(epsilon): a novel Ras effector. *EMBO J.* **20**: 743–754
 - 159 Lopez I., Mak E. C., Ding J., Hamm H. E. and Lomasney J. W. (2001) A novel bifunctional phospholipase c that is regulated by Galpha 12 and stimulates the Ras/mitogen-activated protein kinase pathway. *J. Biol. Chem.* **276**: 2758–2765
 - 160 Song C., Hu C. D., Masago M., Kariyai K., Yamawaki-Kataoka Y., Shibatohe M. et al. (2001) Regulation of a novel human phospholipase C, PLCepsilon, through membrane targeting by Ras. *J. Biol. Chem.* **276**: 2752–2757
 - 161 Wing M. R., Snyder J. T., Sondek J. and Harden T. K. (2003) Direct activation of phospholipase C-epsilon by Rho. *J. Biol. Chem.* **278**: 41253–41258
 - 162 Schmidt M., Evellin S., Weernink P. A., von Dorp F., Rehmann H., Lomasney J. W. et al. (2001) A new phospholipase-C-calcium signalling pathway mediated by cyclic AMP and a Rap GTPase. *Nat. Cell Biol.* **3**: 1020–1024
 - 163 Hains M. D., Siderovski D. P. and Harden T. K. (2004) Application of RGS box proteins to evaluate G-protein selectivity in receptor-promoted signaling. *Methods Enzymol.* **389**: 71–88
 - 164 Kelley G. G., Reks S. E. and Smrcka A. V. (2004) Hormonal regulation of phospholipase Cepsilon through distinct and overlapping pathways involving G12 and Ras family G-proteins. *Biochem. J.* **378**: 129–139
 - 165 Song C., Satoh T., Edamatsu H., Wu D., Tadano M., Gao X. et al. (2002) Differential roles of Ras and Rap1 in growth factor-dependent activation of phospholipase C epsilon. *Oncogene* **21**: 8105–8113
 - 166 Jin T. G., Satoh T., Liao Y., Song C., Gao X., Kariya K. et al. (2001) Role of the CDC25 homology domain of phospholipase Cepsilon in amplification of Rap1-dependent signaling. *J. Biol. Chem.* **276**: 30301–30307

- 167 Wing M. R., Bourdon D. M. and Harden T. K. (2003) PLC-epsilon: a shared effector protein in Ras-, Rho- and $G\alpha\beta\gamma$ -mediated signaling. *Mol. Interv.* **3**: 273–280
- 168 Seifert J. P., Wing M. R., Snyder J. T., Gershburg S., Sondek J. and Harden T. K. (2004) RhoA activates purified phospholipase C-epsilon by a guanine nucleotide-dependent mechanism. *J. Biol. Chem.* **279**:47992–47997
- 169 Illenberger D., Schwald F., Pimmer D., Binder W., Maier G., Dietrich A. et al. (1998) Stimulation of phospholipase C-beta2 by the Rho GTPases Cdc42Hs and Rac1. *EMBO J.* **17**: 6241–6249
- 170 Illenberger D., Walliser C., Nurnberg B., Diaz Lorente M. and Gierschik P. (2003) Specificity and structural requirements of phospholipase C-beta stimulation by Rho GTPases versus G protein beta gamma dimers. *J. Biol. Chem.* **278**: 3006–3014
- 171 Evellin S., Nolte J., Tysack K., vom Dorp F., Thiel M., Weernink P. A. et al. (2002) Stimulation of phospholipase C-epsilon by the M3 muscarinic acetylcholine receptor mediated by cyclic AMP and the GTPase Rap2B. *J. Biol. Chem.* **277**: 16805–16813
- 172 vom Dorp F., Sari A. Y., Sanders H., Keiper M., Weernink P. A., Jakobs K. H. et al. (2004) Inhibition of phospholipase C-epsilon by Gi-coupled receptors. *Cell Signal.* **16**: 921–928
- 173 de Rooij J., Zwartkruis F. J., Verheijen M. H., Cool R. H., Nijman S. M., Wittinghofer A. et al. (1998) Epac is a Rap1 guanine-nucleotide-exchange factor directly activated by cyclic AMP. *Nature* **396**: 474–477
- 174 Springett G. M., Kawasaki H. and Spriggs D. R. (2004) Non-kinase second-messenger signaling: new pathways with new promise. *Bioessays* **26**: 730–738
- 175 Stope M. B., Vom Dorp F., Szatkowski D., Bohm A., Keiper M., Nolte J. et al. (2004) Rap2B-dependent stimulation of phospholipase C-epsilon by epidermal growth factor receptor mediated by c-Src phosphorylation of RasGRP3. *Mol. Cell. Biol.* **24**: 4664–4676
- 176 Ross C. A., MacCumber M. W., Glatt C. E. and Snyder S. H. (1989) Brain phospholipase C isozymes: differential mRNA localizations by in situ hybridization. *Proc. Natl. Acad. Sci. USA* **86**: 2923–2927
- 177 Kim D., Jun K. S., Lee S. B., Kang N. G., Min D. S., Kim Y. H. et al. (1997) Phospholipase C isozymes selectively couple to specific neurotransmitter receptors. *Nature* **389**: 290–293
- 178 Wu D., Tadano M., Edamatsu H., Masago-Toda M., Yamawaki-Kataoka Y., Terashima T. et al. (2003) Neuronal lineage-specific induction of phospholipase Cepsilon expression in the developing mouse brain. *Eur. J. Neurosci.* **17**: 1571–1580
- 179 Clandinin T. R., DeModena J. A. and Sternberg P. W. (1998) Inositol triphosphate mediates a RAS-independent response to LET-23 receptor tyrosine kinase activation in *C. elegans*. *Cell* **92**: 523–533
- 180 Bui Y. K. and Sternberg P. W. (2002) *Caenorhabditis elegans* inositol 5-phosphatase homolog negatively regulates inositol 1,4,5-triphosphate signaling in ovulation. *Mol. Biol. Cell* **13**: 1641–1651
- 181 Kariya K., Kim Bui Y., Gao X., Sternberg P. W. and Kataoka T. (2004) Phospholipase Cepsilon regulates ovulation in *Caenorhabditis elegans*. *Dev. Biol.* **274**: 201–210
- 182 Otsuki M., Fukami K., Kohno T., Yokota J. and Takenawa T. (1999) Identification and characterization of a new phospholipase C-like protein, PLC-L(2). *Biochem. Biophys. Res. Commun.* **266**: 97–103
- 183 Kurosaki T., Maeda A., Ishiai M., Hashimoto A., Inabe K. and Takata M. (2000) Regulation of the phospholipase C-gamma2 pathway in B cells. *Immunol. Rev.* **176**: 19–29
- 184 Takenaka K., Fukami K., Otsuki M., Nakamura Y., Kataoka Y., Wada M. et al. (2003) Role of phospholipase C-L2, a novel phospholipase C-like protein that lacks lipase activity, in B-cell receptor signaling. *Mol. Cell. Biol.* **23**: 7329–7338
- 185 Cismowski M. J., Takesono A., Ma C., Lizano J. S., Xie X., Fuernkranz H. et al. (1999) Genetic screens in yeast to identify mammalian nonreceptor modulators of G-protein signaling. *Nat. Biotechnol.* **17**: 878–883
- 186 Kemppainen R. J. and Behrend E. N. (1998) Dexamethasone rapidly induces a novel ras superfamily member-related gene in AtT-20 cells. *J. Biol. Chem.* **273**: 3129–3131
- 187 Cismowski M. J., Ma C., Ribas C., Xie X., Spruyt M., Lizano J. S. et al. (2000) Activation of heterotrimeric G-protein signaling by a ras-related protein. Implications for signal integration. *J. Biol. Chem.* **275**: 23421–23424
- 188 Graham T. E., Prossnitz E. R. and Dorin R. I. (2002) Dexas1/AGS-1 inhibits signal transduction from the Gi-coupled formyl peptide receptor to Erk-1/2 MAP kinases. *J. Biol. Chem.* **277**: 10876–10882
- 189 Takesono A., Nowak M. W., Cismowski M., Duzic E. and Lanier S. M. (2002) Activator of G-protein signaling 1 blocks GIRK channel activation by a G-protein-coupled receptor: apparent disruption of receptor signaling complexes. *J. Biol. Chem.* **277**: 13827–13830
- 190 Fang M., Jaffrey S. R., Sawa A., Ye K., Luo X. and Snyder S. H. (2000) Dexas1: a G protein specifically coupled to neuronal nitric oxide synthase via CAPON. *Neuron* **28**: 183–193
- 191 Cheng H. Y., Obrietan K., Cain S. W., Lee B. Y., Agostino P. V., Joza N. A. et al. (2004) Dexas1 potentiates photic and suppresses nonphotic responses of the circadian clock. *Neuron* **43**: 715–728
- 192 Takahashi H., Umeda N., Tsutsumi Y., Fukumura R., Ohkaze H., Sujino M. et al. (2003) Mouse dexamethasone-induced RAS protein 1 gene is expressed in a circadian rhythmic manner in the suprachiasmatic nucleus. *Brain Res. Mol. Brain. Res.* **110**: 1–6
- 193 Tall G. G., Kruminis A. M. and Gilman A. G. (2003) Mammalian Ric-8A (Synembryn) is a heterotrimeric Galpha protein guanine nucleotide exchange factor. *J. Biol. Chem.* **278**: 8356–8362
- 194 Granderath S., Stollewerk A., Greig S., Goodman C. S., O’Kane C. J. and Klamt C. (1999) loco encodes an RGS protein required for *Drosophila* glial differentiation. *Development* **126**: 1781–1791
- 195 Siderovski D. P., Diverse-Pierluissi M. A. and DeVries L. (1999) The GoLoco motif: a G alpha i/o binding motif and potential guanine-nucleotide-exchange factor. *Trends Biochem. Sci.* **24**: 340–341
- 196 Takesono A., Cismowski M. J., Ribas C., Bernard M., Chung P., Hazard S. III et al. (1999) Receptor-independent activators of heterotrimeric G-protein signaling pathways. *J. Biol. Chem.* **274**: 33202–33205
- 197 Colombo K., Grill S. W., Kimple R. J., Willard F. S., Siderovski D. P. and Gonczy P. (2003) Translation of polarity cues into asymmetric spindle positioning in *Caenorhabditis elegans* embryos. *Science* **300**: 1957–1961
- 198 Gotta M., Dong Y., Peterson Y. K., Lanier S. M. and Ahringer J. (2003) Asymmetrically distributed *C. elegans* homologs of AGS3/PINS control spindle position in the early embryo. *Curr. Biol.* **13**: 1029–1037
- 199 Srinivasan D. G., Fisk R. M., Xu H. and van den Heuvel S. (2003) A complex of LIN-5 and GPR proteins regulates G protein signaling and spindle function in *C. elegans*. *Genes Dev.* **17**: 1225–1239
- 200 Schaefer M., Shevchenko A., Shevchenko A. and Knoblich J. A. (2000) A protein complex containing Inscuteable and the Galpha-binding protein Pins orients asymmetric cell divisions in *Drosophila*. *Curr. Biol.* **10**: 353–362
- 201 Yu F., Morin X., Cai Y., Yang X. and Chia W. (2000) Analysis of partner of inscuteable, a novel player of *Drosophila* asymmetric divisions, reveals two distinct steps in inscuteable apical localization. *Cell* **100**: 399–409

- 202 Luo Y. and Denker B. M. (1999) Interaction of heterotrimeric G protein Galphao with Purkinje cell protein-2. *J. Biol. Chem.* **274**: 10685–10688
- 203 Zhang X., Zhang H. and Oberdick J. (2002) Conservation of the developmentally regulated dendritic localization of a Purkinje cell-specific mRNA that encodes a G-protein modulator: comparison of rodent and human Pcp2(L7) gene structure and expression. *Brain Res. Mol. Brain. Res.* **105**: 1–10
- 204 Meng J., Glick J. L., Polakis P. and Casey P. J. (1999) Functional interaction between Galpha(z) and Rap1GAP suggests a novel form of cellular cross-talk. *J. Biol. Chem.* **274**: 36663–36669
- 205 Mochizuki N., Ohba Y., Kiyokawa E., Kurata T., Murakami T., Ozaki T. et al. (1999) Activation of the ERK/MAPK pathway by an isoform of rap1GAP associated with G alpha(i). *Nature* **400**: 891–894
- 206 Kimple R. J., Willard F. S., Hains M. D., Jones M. B., Nweke G. K. and Siderovski D. P. (2004) Guanine nucleotide dissociation inhibitor activity of the triple GoLoco motif protein G18: alanine-to-aspartate mutation restores function to an inactive second GoLoco motif. *Biochem. J.* **378**: 801–808
- 207 Cao X., Cismowski M. J., Sato M., Blumer J. B. and Lanier S. M. (2004) Identification and characterization of AGS4: a protein containing three G-protein regulatory motifs that regulate the activation state of Galpha. *J. Biol. Chem.* **279**: 27567–27574
- 208 Mochizuki N., Cho G., Wen B. and Insel P. A. (1996) Identification and cDNA cloning of a novel human mosaic protein, LGN, based on interaction with G alpha i2. *Gene* **181**: 39–43
- 209 Natochin M., Gasimov K. G. and Artemyev N. O. (2001) Inhibition of GDP/GTP exchange on G alpha subunits by proteins containing G-protein regulatory motifs. *Biochemistry* **40**: 5322–5328
- 210 Du Q., Taylor L., Compton D. A. and Macara I. G. (2002) LGN blocks the ability of NuMA to bind and stabilize microtubules. A mechanism for mitotic spindle assembly regulation. *Curr. Biol.* **12**: 1928–1933
- 211 Natochin M., Lester B. R., Peterson Y. K., Bernard M. L., Lanier S. M. and Artemyev N. O. (2000) AGS3 inhibits GDP dissociation from Galpha subunits of Gi family and rhodopsin-dependent activation of transducin. *J. Biol. Chem.* **275**: 40981–40985
- 212 Adhikari A. and Sprang S. R. (2003) Thermodynamic characterization of the binding of activator of G protein signaling 3 (AGS3) and peptides derived from AGS3 with Galpha-i1. *J. Biol. Chem.* **278**: 51825–51832
- 213 Du Q., Stukenberg P. T. and Macara I. G. (2001) A mammalian partner of inscuteable binds NuMA and regulates mitotic spindle organization. *Nat. Cell. Biol.* **3**: 1069–1075
- 214 Dohlman H. G. (2002) G proteins and pheromone signaling. *Annu. Rev. Physiol.* **64**: 129–152
- 215 Chan R. K. and Otte C. A. (1982) Isolation and genetic analysis of *Saccharomyces cerevisiae* mutants supersensitive to G1 arrest by a factor and alpha factor pheromones. *Mol. Cell. Biol.* **2**: 11–20
- 216 Konijn T. M., van de Meene J. G., Chang Y. Y., Barkley D. S. and Bonner J. T. (1969) Identification of adenosine-3',5'-monophosphate as the bacterial attractant for myxamoebae of *Dictyostelium discoideum*. *J. Bacteriol.* **99**: 510–512
- 217 Iijima M., Huang Y. E. and Devreotes P. (2002) Temporal and spatial regulation of chemotaxis. *Dev. Cell* **3**: 469–478
- 218 Wettenschuck N., Moers A. and Offermanns S. (2004) Mouse models to study G-protein-mediated signaling. *Pharmacol. Ther.* **101**: 75–89
- 219 Ullah H., Chen J. G., Young J. C., Im K. H., Sussman M. R. and Jones A. M. (2001) Modulation of cell proliferation by heterotrimeric G protein in *Arabidopsis*. *Science* **292**: 2066–2069
- 220 Wang X. Q., Ullah H., Jones A. M. and Assmann S. M. (2001) G protein regulation of ion channels and abscisic acid signaling in *Arabidopsis* guard cells. *Science* **292**: 2070–2072
- 221 Jones A. M. (2002) G-protein-coupled signaling in *Arabidopsis*. *Curr Opin Plant Biol* **5**: 402–407
- 222 Apone F., Alyeshmerni N., Wiens K., Chalmers D., Chrispeels M. J. and Colucci G. (2003) The G-protein-coupled receptor GCR1 regulates DNA synthesis through activation of phosphatidylinositol-specific phospholipase C. *Plant Physiol.* **133**: 571–579
- 223 Zhao J. and Wang X. (2004) *Arabidopsis* phospholipase Dalpha1 interacts with the heterotrimeric G-protein alpha-subunit through a motif analogous to the DRY motif in G-protein-coupled receptors. *J Biol Chem* **279**: 1794–1800
- 224 Chen J.-G., Willard F. S., Huang J., Liang J., Chasse S. A., Jones A. M. et al. (2003) A seven-transmembrane RGS protein that modulates plant cell proliferation. *Science* **301**: 1728–1731
- 225 Willard F. S. and Siderovski D. P. (2004) Purification and in vitro functional analysis of the *Arabidopsis thaliana* regulator of G-protein signaling-1. *Methods Enzymol.* **389**: 320–338
- 226 Chen J. G. and Jones A. M. (2004) AtRGS1 function in *Arabidopsis thaliana*. *Methods Enzymol.* **389**: 338–350
- 227 Wang Q., Liu M., Mullah B., Siderovski D. P. and Neubig R. R. (2002) Receptor-selective effects of endogenous RGS3 and RGS5 to regulate mitogen-activated protein kinase activation in rat vascular smooth muscle cells. *J. Biol. Chem.* **277**: 24949–24958
- 228 Xu X., Zeng W., Popov S., Berman D. M., Davignon I., Yu K. et al. (1999) RGS proteins determine signaling specificity of Gq-coupled receptors. *J. Biol. Chem.* **274**: 3549–3556
- 229 Zeng W., Xu X., Popov S., Mukhopadhyay S., Chidiac P., Swistok J. et al. (1998) The N-terminal domain of RGS4 confers receptor-selective inhibition of G protein signaling. *J. Biol. Chem.* **273**: 34687–34690
- 230 Bernstein L. S., Ramineni S., Hague C., Cladman W., Chidiac P., Levey A. I. et al. (2004) RGS2 binds directly and selectively to the M1 muscarinic acetylcholine receptor third intracellular loop to modulate Gq/11alpha signaling. *J. Biol. Chem.* **279**: 21248–21256
- 231 Zhong H., Wade S. M., Woolf P. J., Linderman J. J., Traynor J. R. and Neubig R. R. (2003) A spatial focusing model for G protein signals. Regulator of G protein signaling (RGS) protein-mediated kinetic scaffolding. *J. Biol. Chem.* **278**: 7278–7284
- 232 Worby C. A. and Dixon J. E. (2002) Sorting out the cellular functions of sorting nexins. *Nat. Rev. Mol. Cell. Biol.* **3**: 919–931
- 233 Popov S. G., Krishna U. M., Falck J. R. and Wilkie T. M. (2000) Ca²⁺/Calmodulin reverses phosphatidylinositol 3,4,5-trisphosphate-dependent inhibition of regulators of G protein-signaling GTPase-activating protein activity. *J. Biol. Chem.* **275**: 18962–18968
- 234 Tu Y. and Wilkie T. M. (2004) Allosteric regulation of GAP activity by rholipids in regulators of G-protein signaling. *Methods Enzymol.* **389**: 89–1005
- 235 Ishii M. and Kurachi Y. (2004) Assays of RGS protein modulation by phosphatidylinositides and calmodulin. *Methods Enzymol.* **389**: 105–118
- 236 Tu Y., Popov S., Slaughter C. and Ross E. M. (1999) Palmitoylation of a conserved cysteine in the regulator of G protein signaling (RGS) domain modulates the GTPase-activating activity of RGS4 and RGS10. *J. Biol. Chem.* **274**: 38260–38267
- 237 Jones T. L. (2004) Role of palmitoylation in RGS protein function. *Methods Enzymol.* **389**: 33–55
- 238 Ishii M., Inanobe A. and Kurachi Y. (2002) PIP3 inhibition of RGS protein and its reversal by Ca²⁺/calmodulin mediate

- voltage-dependent control of the G protein cycle in a cardiac K⁺ channel. Proc. Natl. Acad. Sci. USA **99**: 4325–4330
- 239 Roy A. A., Lemberg K. E. and Chidiac P. (2003) Recruitment of RGS2 and RGS4 to the plasma membrane by G proteins and receptors reflects functional interactions. Mol. Pharmacol. **64**: 587–593
- 240 Druey K. M., Sullivan B. M., Brown D., Fischer E. R., Watson N., Blumer K. J. et al. (1998) Expression of GTPase-deficient Gialpha2 results in translocation of cytoplasmic RGS4 to the plasma membrane. J. Biol. Chem. **273**: 18405–18410
- 241 Krumins A. M., Barker S. A., Huang C., Sunahara R. K., Yu K., Wilkie T. M. et al. (2004) Differentially regulated expression of endogenous RGS4 and RGS7. J. Biol. Chem. **279**: 2593–2599
- 242 Wise A., Jupe S. C. and Rees S. (2004) The identification of ligands at orphan G-protein coupled receptors. Annu. Rev. Pharmacol. Toxicol. **44**: 43–66
- 243 Coursol S., Fan L. M., Le Stunff H., Spiegel S., Gilroy S. and Assmann S. M. (2003) Sphingolipid signalling in *Arabidopsis* guard cells involves heterotrimeric G proteins. Nature **423**: 651–654
- 244 Chun J., Goetzl E. J., Hla T., Igarashi Y., Lynch K. R., Moolenaar W. et al. (2002) International Union of Pharmacology. XXXIV. Lysophospholipid receptor nomenclature. Pharmacol. Rev. **54**: 265–269
- 245 Gonczy P. (2002) Mechanisms of spindle positioning: focus on flies and worms. Trends Cell Biol. **12**: 332–339
- 246 Macara I. G. (2004) Parsing the polarity code. Nat. Rev. Mol. Cell Biol. **5**: 220–231
- 247 Wodarz A. and Huttner W. B. (2003) Asymmetric cell division during neurogenesis in *Drosophila* and vertebrates. Mech. Dev. **120**: 1297–1309
- 248 Chia W. and Yang X. (2002) Asymmetric division of *Drosophila* neural progenitors. Curr. Opin. Genet. Dev. **12**: 459–464
- 249 Vaessin H., Grell E., Wolff E., Bier E., Jan L. Y. and Jan Y. N. (1991) Prospero is expressed in neuronal precursors and encodes a nuclear protein that is involved in the control of axonal outgrowth in *Drosophila*. Cell **67**: 941–953
- 250 Doe C. Q., Chu-LaGriff Q., Wright D. M. and Scott M. P. (1991) The prospero gene specifies cell fates in the *Drosophila* central nervous system. Cell **65**: 451–464
- 251 Knoblich J. A., Jan L. Y. and Jan Y. N. (1995) Asymmetric segregation of Numb and Prospero during cell division. Nature **377**: 624–627
- 252 Hirata J., Nakagoshi H., Nabeshima Y. and Matsuzaki F. (1995) Asymmetric segregation of the homeodomain protein Prospero during *Drosophila* development. Nature **377**: 627–630
- 253 Spana E. P. and Doe C. Q. (1995) The prospero transcription factor is asymmetrically localized to the cell cortex during neuroblast mitosis in *Drosophila*. Development **121**: 3187–3195
- 254 Schuldt A. J., Adams J. H., Davidson C. M., Micklem D. R., Haseloff J., St Johnston D. et al. (1998) Miranda mediates asymmetric protein and RNA localization in the developing nervous system. Genes Dev. **12**: 1847–1857
- 255 Li P., Yang X., Wasser M., Cai Y. and Chia W. (1997) Inscuteable and Staufen mediate asymmetric localization and segregation of prospero RNA during *Drosophila* neuroblast cell divisions. Cell **90**: 437–447
- 256 Broadus J., Fuerstenberg S. and Doe C. Q. (1998) Staufen-dependent localization of prospero mRNA contributes to neuroblast daughter-cell fate. Nature **391**: 792–795
- 257 Shen C. P., Jan L. Y. and Jan Y. N. (1997) Miranda is required for the asymmetric localization of Prospero during mitosis in *Drosophila*. Cell **90**: 449–458
- 258 Ikeshima-Kataoka H., Skeath J. B., Nabeshima Y., Doe C. Q. and Matsuzaki F. (1997) Miranda directs Prospero to a daughter cell during *Drosophila* asymmetric divisions. Nature **390**: 625–629
- 259 Guo M., Jan L. Y. and Jan Y. N. (1996) Control of daughter cell fates during asymmetric division: interaction of Numb and Notch. Neuron **17**: 27–41
- 260 Frise E., Knoblich J. A., Younger-Shepherd S., Jan L. Y. and Jan Y. N. (1996) The *Drosophila* Numb protein inhibits signaling of the Notch receptor during cell-cell interaction in sensory organ lineage. Proc. Natl. Acad. Sci. USA **93**: 11925–11932
- 261 Lu B., Rothenberg M., Jan L. Y. and Jan Y. N. (1998) Partner of Numb colocalizes with Numb during mitosis and directs Numb asymmetric localization in *Drosophila* neural and muscle progenitors. Cell **95**: 225–235
- 262 Berdnik D., Torok T., Gonzalez-Gaitan M. and Knoblich J. A. (2002) The endocytic protein alpha-Adaptin is required for numb-mediated asymmetric cell division in *Drosophila*. Dev. Cell **3**: 221–231
- 263 Kraut R. and Campos-Ortega J. A. (1996) Inscuteable, a neural precursor gene of *Drosophila*, encodes a candidate for a cytoskeleton adaptor protein. Deve. Biol. **174**: 65–81
- 264 Kraut R., Chia W., Jan L. Y., Jan Y. N. and Knoblich J. A. (1996) Role of inscuteable in orienting asymmetric cell divisions in *Drosophila*. Nature **383**: 50–55
- 265 Schober M., Schaefer M. and Knoblich J. A. (1999) Bazooka recruits Inscuteable to orient asymmetric cell divisions in *Drosophila* neuroblasts. Nature **402**: 548–551
- 266 Schaefer M. and Knoblich J. A. (2001) Protein localization during asymmetric cell division. Exp. Cell Res. **271**: 66–74
- 267 Schaefer M., Petronczki M., Dorner D., Forte M. and Knoblich J. A. (2001) Heterotrimeric G proteins direct two modes of asymmetric cell division in the *Drosophila* nervous system. Cell **107**: 183–194
- 268 Kaushik R., Yu F., Chia W., Yang X. and Bahri S. (2003) Subcellular localization of LGN during mitosis: evidence for its cortical localization in mitotic cell culture systems and its requirement for normal cell cycle progression. Mol. Biol. Cell. **14**: 3144–3155
- 269 Jiang X., Wilford C., Duensing S., Munger K., Jones G. and Jones D. (2001) Participation of Survivin in mitotic and apoptotic activities of normal and tumor-derived cells. J. Cell. Biochem. **83**: 342–354
- 270 Cai Y., Chia W. and Yang X. (2001) A family of snail-related zinc finger proteins regulates two distinct and parallel mechanisms that mediate *Drosophila* neuroblast asymmetric divisions. EMBO J. **20**: 1704–1714
- 271 Izumi Y., Ohta N., Itoh-Furuya A., Fuse N. and Matsuzaki F. (2004) Differential functions of G protein and Baz-aPKC signaling pathways in *Drosophila* neuroblast asymmetric division. J. Cell Biol. **164**: 729–738
- 272 Fuse N., Hisata K., Katzen A. L. and Matsuzaki F. (2003) Heterotrimeric G proteins regulate daughter cell size asymmetry in *Drosophila* neuroblast divisions. Curr. Biol. **13**: 947–954
- 273 Yu F., Cai Y., Kaushik R., Yang X. and Chia W. (2003) Distinct roles of Galpha-i and Gbeta13F subunits of the heterotrimeric G protein complex in the mediation of *Drosophila* neuroblast asymmetric divisions. J. Cell Biol. **162**: 623–633
- 274 Fuja T. J., Schwartz P. H., Darcy D. and Bryant P. J. (2004) Asymmetric localization of LGN but not AGS3, two homologs of *Drosophila* pins, in dividing human neural progenitor cells. J Neurosci Res **75**: 782–793
- 275 Hartenstein V. and Posakony J. W. (1989) Development of adult sensilla on the wing and notum of *Drosophila* melanogaster. Development **107**: 389–405
- 276 Gho M., Bellaiche Y. and Schweisguth F. (1999) Revisiting the *Drosophila* microchaete lineage: a novel intrinsically asymmetric cell division generates a glial cell. Development **126**: 3573–3584

- 277 Rhyu M. S., Jan L. Y. and Jan Y. N. (1994) Asymmetric distribution of numb protein during division of the sensory organ precursor cell confers distinct fates to daughter cells. *Cell* **76**: 477–491
- 278 Cai Y., Yu F., Lin S., Chia W. and Yang X. (2003) Apical complex genes control mitotic spindle geometry and relative size of daughter cells in *Drosophila* neuroblast and pI asymmetric divisions. *Cell* **112**: 51–62
- 279 Roegiers F. (2003) Insights into mRNA transport in neurons. *Proc. Natl. Acad. Sci. USA* **100**: 1465–1466
- 280 Bellaïche Y., Radovic A., Woods D. F., Hough C. D., Parmentier M. L., O’Kane C. J. et al. (2001) The partner of Inscutable/Disks-large complex is required to establish planar polarity during asymmetric cell division in *Drosophila*. *Cell* **106**: 355–366
- 281 Malbon C. C. (2004) Frizzleds: new members of the superfamily of G-protein-coupled receptors. *Front. Biosci.* **9**: 1048–1058
- 282 Bellaïche Y., Gho M., Kaltschmidt J. A., Brand A. H. and Schweisguth F. (2001) Frizzled regulates localization of cell-fate determinants and mitotic spindle rotation during asymmetric cell division. *Nat. Cell. Biol.* **3**: 50–57
- 283 Gonczy P., Grill S., Stelzer E. H., Kirkham M. and Hyman A. A. (2001) Spindle positioning during the asymmetric first cell division of *Caenorhabditis elegans* embryos. *Novartis Found. Symp.* **237**: 164–175
- 284 Knoblich J. A. (2001) Asymmetric cell division during animal development. *Nat. Rev. Mol. Cell. Biol.* **2**: 11–20
- 285 Schneider S. Q. and Bowerman B. (2003) Cell polarity and the cytoskeleton in the *Caenorhabditis elegans* zygote. *Annu. Rev. Genet.* **37**: 221–249
- 286 Kemphues K. J., Priess J. R., Morton D. G. and Cheng N. S. (1988) Identification of genes required for cytoplasmic localization in early *C. elegans* embryos. *Cell* **52**: 311–320
- 287 Etemad-Moghadam B., Guo S. and Kemphues K. J. (1995) Asymmetrically distributed PAR-3 protein contributes to cell polarity and spindle alignment in early *C. elegans* embryos. *Cell* **83**: 743–752
- 288 Hung T. J. and Kemphues K. J. (1999) PAR-6 is a conserved PDZ domain-containing protein that colocalizes with PAR-3 in *Caenorhabditis elegans* embryos. *Development* **126**: 127–135
- 289 Tabuse Y., Izumi Y., Piano F., Kemphues K. J., Miwa J. and Ohno S. (1998) Atypical protein kinase C cooperates with PAR-3 to establish embryonic polarity in *Caenorhabditis elegans*. *Development* **125**: 3607–3614
- 290 Gotta M., Abraham M. C. and Ahringer J. (2001) CDC-42 controls early cell polarity and spindle orientation in *C. elegans*. *Curr Biol* **11**: 482–488
- 291 Gotta M. and Ahringer J. (2001) Distinct roles for Galpha and Gbetagamma in regulating spindle position and orientation in *Caenorhabditis elegans* embryos. *Nat. Cell. Biol.* **3**: 297–300
- 292 Watts J. L., Morton D. G., Bestman J. and Kemphues K. J. (2000) The *C. elegans* par-4 gene encodes a putative serine-threonine kinase required for establishing embryonic asymmetry. *Development* **127**: 1467–1475
- 293 Zwaal R. R., Ahringer J., van Luenen H. G., Rushforth A., Anderson P. and Plasterk R. H. (1996) G proteins are required for spatial orientation of early cell cleavages in *C. elegans* embryos. *Cell* **86**: 619–629
- 294 Afshar K., Willard F. S., Colombo K., Johnston C. A., McCudden C. R., Siderovski D. P. et al. (2004) RIC-8 is required for GPR-1/2-dependent G-alpha function during asymmetric division of *C. elegans* embryos. *Cell* **119**: 219–230
- 295 Grill S. W., Howard J., Schaffer E., Stelzer E. H. K. and Hyman A. A. (2003) The distribution of active force generators controls mitotic spindle position. *Science* **301**: 518–521
- 296 Verdi J. M., Schmandt R., Bashirullah A., Jacob S., Salvino R., Craig C. G. et al. (1996) Mammalian NUMB is an evolutionarily conserved signaling adapter protein that specifies cell fate. *Curr. Biol.* **6**: 1134–1145
- 297 Cayouette M. and Raff M. (2002) Asymmetric segregation of Numb: a mechanism for neural specification from *Drosophila* to mammals. *Nat. Neurosci.* **5**: 1265–1269
- 298 Blumer J. B., Chandler L. J. and Lanier S. M. (2002) Expression analysis and subcellular distribution of the two G-protein regulators AGS3 and LGN indicate distinct functionality. Localization of LGN to the midbody during cytokinesis. *J. Biol. Chem.* **277**: 15897–15903
- 299 Cleveland D. W. (1995) NuMA: a protein involved in nuclear structure, spindle assembly, and nuclear re-formation. *Trends Cell Biol.* **5**: 60–64
- 300 Yu F., Ong C. T., Chia W. and Yang X. (2002) Membrane targeting and asymmetric localization of *Drosophila* partner of inscuteable are discrete steps controlled by distinct regions of the protein. *Mol. Cell. Biol.* **22**: 4230–4240
- 301 Broadus J. and Doe C. Q. (1997) Extrinsic cues, intrinsic cues and microfilaments regulate asymmetric protein localization in *Drosophila* neuroblasts. *Curr. Biol.* **7**: 827–835
- 302 Qian X., Goderie S. K., Shen Q., Stern J. H. and Temple S. (1998) Intrinsic programs of patterned cell lineages in isolated vertebrate CNS ventricular zone cells. *Development* **125**: 3143–3152
- 303 Miller K. G. and Rand J. B. (2000) A role for RIC-8 (Synembryn) and GOA-1 (Go-alpha) in regulating a subset of centrosome movements during early embryogenesis in *Caenorhabditis elegans*. *Genetics* **156**: 1649–1660
- 304 Couwenbergs C., Spilker A. C. and Gotta M. (2004) Control of embryonic spindle positioning and G-alpha activity by *C. elegans* RIC-8. *Curr. Biol.* **14**: 1871–1876
- 305 Hess H. A., Roper J.-C., Grill S. W. and Koelle M. R. (2004) RGS-7 completes a receptor-independent heterotrimeric G protein cycle to asymmetrically regulate mitotic spindle positioning in *C. elegans*. *Cell* **119**: 209–218
- 306 Martin-McCaffrey L., Willard F. S., Oliveira-dos-Santos A. J., Natale D. R. C., Snow B. E., Kimple R. J. et al. (2004) RGS14 is a mitotic spindle protein essential from the first division of the mammalian zygote. *Developmental Cell* **7**: 763–769
- 307 Martin-McCaffrey L., Willard F. S., Pajak A., Dagnino L., Siderovski D. P. and D’Souza S. J. A. (2004) Analysis of interactions between Regulator of G-protein Signaling-14 and microtubules. *Methods Enzymol.* **390**: 240–258
- 308 Chen N.-F., Yu J.-Z., Skiba N. P., Hamm H. E. and Rasenick M. M. (2003) A specific domain of Gialpha required for the transactivation of Gialpha by tubulin is implicated in the organization of cellular microtubules. *J. Biol. Chem.* **278**: 15285–15290
- 309 Popova J. S. and Rasenick M. M. (2003) Gbg mediates the interplay between tubulin dimers and microtubules in the modulation of Gq signaling. *J. Biol. Chem.* **278**: 34299–34308
- 310 Roychowdhury S., Panda D., Wilson L. and Rasenick M. M. (1999) G protein alpha subunits activate tubulin GTPase and modulate microtubule polymerization dynamics. *J. Biol. Chem.* **274**: 13485–13490
- 311 Roychowdhury S. and Rasenick M. M. (1997) G Protein beta 1gamma 2 subunits promote microtubule assembly. *J. Biol. Chem.* **272**: 31576–31581
- 312 Wang N., Yan K. and Rasenick M. (1990) Tubulin binds specifically to the signal-transducing proteins, Gs alpha and Gi alpha 1. *J. Biol. Chem.* **265**: 1239–1242
- 313 Sarma T., Voyno-Yasenetskaya T., Hope T. J. and Rasenick M. M. (2003) Heterotrimeric G-proteins associate with microtubules during differentiation in PC12 pheochromocytoma cells. *FASEB J.* **17**: 848–859

- 314 Labbe J.-C., Maddox P. S., Salmon E. D. and Goldstein B. (2003) PAR proteins regulate microtubule dynamics at the cell cortex in *C. elegans*. *Curr. Biol.* **13**: 707–714
- 315 Ghosh M., Peterson Y. K., Lanier S. M. and Smrcka A. V. (2003) Receptor- and nucleotide exchange-independent mechanisms for promoting G protein subunit dissociation. *J. Biol. Chem.* **278**: 34747–34750
- 316 Webb C. K., McCudden C. R., Willard F. S., Kimple R. J., Siderovski D. P. and Oxford G. S. (2005) D2 dopamine receptor activation of potassium channels is selectively decoupled by G-alpha-i-specific GoLoco motif peptides. *J. Neurochem.* in press
- 317 Tsou M.-F. B., Hayashi A. and Rose L. S. (2003) LET-99 opposes Galpha/GPR signaling to generate asymmetry for spindle positioning in response to PAR and MES-1/SRC-1 signaling. *Development* **130**: 5717–5730
- 318 Ross E. M. and Wilkie T. M. (2000) GTPase-activating proteins for heterotrimeric G proteins: regulators of G protein signaling (RGS) and RGS-like proteins. *Annu. Rev. Biochem.* **69**: 795–827
- 319 Singer A. U., Waldo G. L., Harden T. K. and Sondek J. (2002) A unique fold of phospholipase C-beta mediates dimerization and interaction with G alpha q. *Nat. Struct. Biol.* **9**: 32–36
- 320 Wang Z. and Moran M. F. (2002) Phospholipase C-gamma1: a phospholipase and guanine nucleotide exchange factor. *Mol. Interv.* **2**: 352–355



To access this journal online:
<http://www.birkhauser.ch>
