

Research article

Open Access

## Genetic noise control via protein oligomerization

Cheol-Min Ghim and Eivind Almaas\*

Address: Microbial Systems Biology Group, Biosciences and Biotechnology Division, Lawrence Livermore National Laboratory, 7000 East Avenue Livermore, CA 94550, USA

Email: Cheol-Min Ghim - [ghim1@llnl.gov](mailto:ghim1@llnl.gov); Eivind Almaas\* - [almaas@llnl.gov](mailto:almaas@llnl.gov)

\* Corresponding author

Published: 3 November 2008

Received: 14 June 2008

*BMC Systems Biology* 2008, **2**:94 doi:10.1186/1752-0509-2-94

Accepted: 3 November 2008

This article is available from: <http://www.biomedcentral.com/1752-0509/2/94>

© 2008 Ghim and Almaas; licensee BioMed Central Ltd.

This is an Open Access article distributed under the terms of the Creative Commons Attribution License (<http://creativecommons.org/licenses/by/2.0>), which permits unrestricted use, distribution, and reproduction in any medium, provided the original work is properly cited.

### Abstract

**Background:** Gene expression in a cell entails random reaction events occurring over disparate time scales. Thus, molecular noise that often results in phenotypic and population-dynamic consequences sets a fundamental limit to biochemical signaling. While there have been numerous studies correlating the architecture of cellular reaction networks with noise tolerance, only a limited effort has been made to understand the dynamic role of protein-protein interactions.

**Results:** We have developed a fully stochastic model for the positive feedback control of a single gene, as well as a pair of genes (toggle switch), integrating quantitative results from previous *in vivo* and *in vitro* studies. In particular, we explicitly account for the fast binding-unbinding kinetics among proteins, RNA polymerases, and the promoter/operator sequences of DNA. We find that the overall noise-level is reduced and the frequency content of the noise is dramatically shifted to the physiologically irrelevant high-frequency regime in the presence of protein dimerization. This is independent of the choice of monomer or dimer as transcription factor and persists throughout the multiple model topologies considered. For the toggle switch, we additionally find that the presence of a protein dimer, either homodimer or heterodimer, may significantly reduce its random switching rate. Hence, the dimer promotes the robust function of bistable switches by preventing the uninduced (induced) state from randomly being induced (uninduced).

**Conclusion:** The specific binding between regulatory proteins provides a buffer that may prevent the propagation of fluctuations in genetic activity. The capacity of the buffer is a non-monotonic function of association-dissociation rates. Since the protein oligomerization *per se* does not require extra protein components to be expressed, it provides a basis for the rapid control of intrinsic or extrinsic noise. The stabilization of regulatory circuits and epigenetic memory in general is of direct implications to organism fitness. Our results also suggest possible avenues for the design of synthetic gene circuits with tunable robustness for a wide range of engineering purposes.

### Background

Recent experiments on isogenic populations of microbes with single-cell resolution [1-3] have demonstrated that stochastic fluctuations, or noise, can override genetic and environmental determinism. In fact, the presence of noise

may significantly affect the fitness of an organism [4]. The traditional approach for modeling the process of molecular synthesis and degradation inside a cell is by deterministic rate equations, where the continuous change of arbitrarily small fractions of molecules is controlled

instantaneously and frequently represented through sigmoidal dose-response relations. However, the rate-equation approaches can not explain the observed phenotypic variability in an isogenic population in stable environments. In particular, when molecules involved in feedback control exist in low copy numbers, noise may give rise to significant cell-to-cell variation as many regulatory events are triggered by molecules with very low copy numbers  $\leq 100$  [5]. A well known example is the regulation of inorganic trace elements [6], such as iron, copper, and zinc. While these trace elements are essential for the activity of multiple enzymes, their presence may quickly turn cytotoxic unless their concentrations are carefully controlled.

Although the presence of phenotypic variation due to stochastic fluctuations need not be detrimental for a population of cells [7], elaborate regulatory mechanisms have evolved to attenuate noise [8]. Several systems-biology studies have recently focused on a select set gene-regulatory circuits, in particular those with feedback control. Feedback control circuits have been identified as important for multiple species and proven responsible for noise reduction and increased functional stability in many housekeeping genes through negative autoregulation [9], long cascades of ultrasensitive signaling [10], bacterial chemotaxis [11], and the circadian clock [12]. Additionally, recent studies on iron homeostasis [13,14] in *E. coli* highlight the noise-reducing capability mediated by small RNAs.

Here, we study reversible protein-protein binding as a novel source for genetic noise control. In particular, we have quantitatively analyzed the effects of protein oligomerization on noise in positive autoregulatory circuits as well as a simple toggle-switch [15]. The all-or-none threshold behavior of positive-feedback circuits typically improves robustness against "leaky" switching. However, due to their functional purposes, gene circuits involved in developmental processes or stress responses that often accompany genome-wide changes in gene expression are intrinsically noisier than negative feedback circuits.

It is frequently observed that transcription factors exist in oligomeric form [16], and protein oligomerization is an important subset of protein-protein interactions, constituting a recurring theme in enzymatic proteins as well as regulatory proteins. Well studied examples include the  $\lambda$ -phage repressor,  $\lambda$ CI (dimer), the TrpR (dimer), LacR (tetramer), and Lrp (hexadecamer or octamer). While many of the RNA-binding proteins dimerize exclusively in the cytosol, the LexA repressor [17], the leucine-zipper activator [18,19], and the Arc repressor [20] have been shown to form an oligomer either in the cytosol ("dimer path") or on the DNA by sequential binding ("monomer

path"). Previously, the efficacy of monomer and dimer transcription-regulation paths to reduce noise was separately studied for a negative-feedback autoregulatory circuit [21]. In contrast, we have focused on oligomerization in positive-feedback autoregulatory circuits, as well as genetic toggle switches based on the mutual repression of genes [15]. We find that cytosolic transcription-factor oligomerization acts as a significant buffer for abundance-fluctuations in the monomer, overall reducing noise in the circuit. Additionally, the noise-power spectral density is shifted from the low-to the high-frequency regime. In the toggle switch, cytosolic oligomerization may significantly stabilize the functional state of the circuit. This is especially evident for heterodimerization.

Yet another interesting case of ligand-binding-mediated receptor oligomerization has been reported [22,23], where the formation of various structures of oligomers may act to buffer the intracellular signaling against noise. Although our modeling and analysis is based on prokaryotic cells, we expect our main findings to be organism independent since protein oligomers, especially homodimers, is such a common occurrence across the species [24], with homodimers comprising 12.6% of the high-fidelity human proteome [25,26].

## Results and Discussion

### **Dimerization breaks long-time noise correlations in autogenous circuit**

To evaluate the dynamic effects of protein-protein binding in positive-autoregulation gene circuits, we construct several alternative models of positive autogenous circuits. Each model emphasizes a different combination of possible feedback mechanisms, and the network topologies considered can be grouped into the two classes of monomer-only (MO) and dimer-allowed (DA) circuits, according to the availability of a protein-dimer state (color coding in Fig. 1). We further group the DA circuits into three variations, DA1 through DA3, depending on which form of the protein is the functional transcription factor (TF) and where the dimerization occurs. For DA1, we only allow the dimer to bind with the DNA-operator sequence (dimeric transcription factor, DTF), while for DA2 dimerization occurs through sequential binding of monomers on the DNA. In DA3, the protein-DNA binding kinetics is the same as in the MO circuit, hence monomeric transcription factor (MTF), with the addition of a cytosolic protein dimer state. While we will only present results for DA1 in this paper, there is no significant difference for DA2 and DA3 [Additional file 1].

Note that the feedback loop is not explicit in Fig. 1 but implicitly included through the dependence of RNAP-promoter binding equilibrium on the binding status of the TF-operator pair. The sign (positive or negative) and

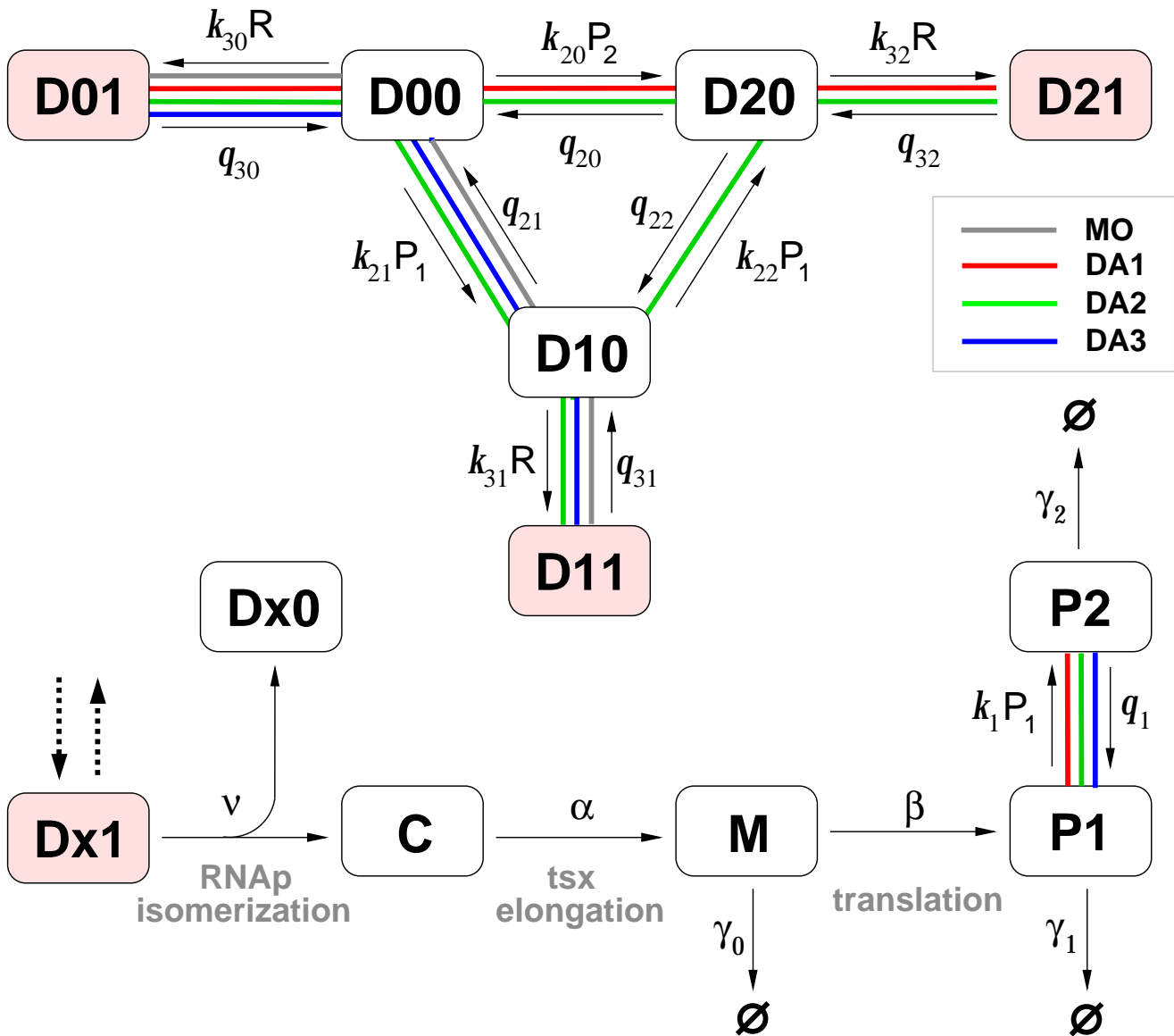

**Figure 1**  
**Schematic of model autoregulation gene circuit.** The DNA binding status is indicated by  $D_{xy}$ , where  $x$  corresponds to the operator region (empty = 0, monomer = 1, dimer = 2), and  $y$  to the promoter region (empty = 0, RNA polymerase bound = 1).  $C$  represents the open complex of DNA-RNAP holoenzyme with the promoter sequence just cleared of RNAP and is subject to transcription elongation. Finally,  $M$ ,  $P1$  and  $P2$  correspond to mRNA, protein monomer, and dimer, respectively. The network topologies can be grouped into two classes, monomer-only (MO) or dimer-allowed (DA) circuits. We have studied DA1 (red lines), which only allows the dimer to bind with the DNA-operator sequence, DA2 (green) with sequential binding of monomers on the DNA, and DA3 (blue), which shares protein-DNA binding kinetics with MO while allowing dimerization in the cytosol. Note that for topology DA2, we have chosen  $K_{31} = K_{30}$  (see text for details) We have assumed cells to be in the exponential growth phase and the number of RNAP ( $R$ ) constant.

strength of the feedback control is determined by the relative magnitude of the dissociation constants between RNAP and DNA which is either free or TF-bound. For instance, topology DA1 has positive feedback control if  $K_{30} = k_{30}/q_{30} > K_{32} = k_{32}/q_{32}$ , and  $K_{30}$  corresponds to the

level of constitutive transcription (transcription initiation in the absence of bound transcription factor). For each topology, we study the dependence of noise characteristics on the kinetic rates by varying the dimer lifetime, binding affinity, and the individual association/dissocia-

tion rates (see Table and Fig. 1). While we only discuss positive feedback control of the autogenous circuit in this paper, we have obtained corresponding results for negative feedback control [Additional file 1].

Fig. 2 shows a sample of ten representative time courses for the protein abundance. The effect of stochastic fluctuations is marked in the MO circuit. However, in all the DA circuits where the protein may form a cytosolic dimer we observe a significantly reduced level of noise in the monomer abundance. The suppression of fluctuations persists throughout the range of kinetic parameters that (so far) is known to be physiologically relevant (see Table 1).

Calculating the steady-state distribution for the monomer and dimer abundances (Fig. 3) we observe a clear trend that the monomer Fano factor (variance-to-mean ratio) is reduced as the binding equilibrium is shifted towards the dimer. This trend is conserved for all the investigated DA topologies (see *Supplementary Information*). As long as dimerization is allowed in the cytosol, the fast-binding equilibrium absorbs long-time fluctuations stemming from bursty synthesis or decay of the monomer. When a random fluctuation brings about a sudden change in the monomer copy number, dimerization provides a buffering pool that absorbs the sudden change. Otherwise, random bursts in the monomer abundance will propagate to the transcriptional activity of the promoter, leading to erratic control of protein expression. It should be emphasized that this has nothing to do with the sign of regulation and is in agreement with the observations of Ref. [21]

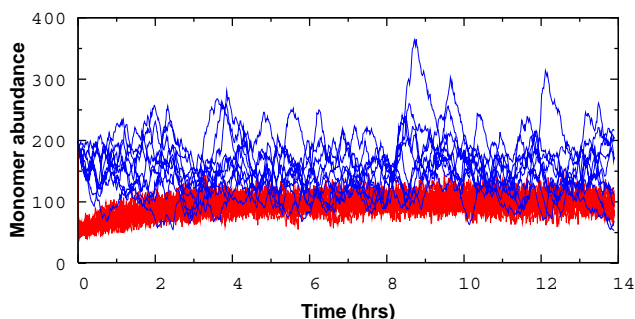

**Figure 2**  
**Ten independent time courses of the abundance of protein monomers in the (positive) autoregulatory circuit.** The availability of a cytosolic dimer state (red, using circuit topology DA1) significantly reduces the copy-number fluctuations of the monomer compared to the monomer-only (MO) circuit (blue). All corresponding MO and DA1 parameters have the same values. In the ensuing simulations initial conditions are chosen to be the steady state solution of the corresponding deterministic rate equation so that the transient behavior should be minimized.

for negative autoregulation. Surprisingly, the magnitude of noise reduction in the positive autoregulatory circuit is nearly the same as that for negative autoregulation which is typically considered a highly stable construct [Additional file 1].

A heuristic explanation can be found from Jacobian analysis of a deterministic dynamical system, which is justified for small perturbations around a steady state. When a random fluctuation shifts the monomer copy number away from its steady-state value, the decay toward the steady state can be described by the system Jacobian. The disparity in the magnitude of the (negative) eigenvalues of the Jacobian matrix for the MO versus the DA circuits signifies that the perturbed state is buffered by fast settlement of the monomer-dimer equilibrium. This buffering occurs before random fluctuation can accumulate, possibly with catastrophic physiological effects, explaining the coarse long-time patterns observed in the MO model in contrast with the DA circuits (Fig. 2).

#### **Frequency-selective whitening of Brownian noise**

The dimerization process itself generates stochastic fluctuations on a short time scale. However, since this time scale is essentially separated from that of monomer synthesis and decay (orders of magnitude faster), dimerization effectively mitigates monomer-level fluctuations. The frequency content of the fluctuations is best studied by an analysis of the power spectral density (PSD), which is defined as the Fourier transform of the autocorrelation function [27], originally introduced for signal processing. Fig. 4 shows the noise power spectra of DA1, and the distinction between the MO circuit and the DA topology is immediately evident. In particular, we note the following two features. (i) A power-law decay with increasing frequency and (ii) a horizontal plateau for the DA circuits. The power-law feature is explained by the "random walk" nature of protein synthesis and decay: The power-law exponent is approximately 2, which is reminiscent of Brownian motion (a Wiener process) in the limit of large molecular copy numbers. Compared to other commonly observed signals, such as white (uncorrelated) noise or  $1/f$  noise, protein synthesis/decay has a longer correlation time. If the autocorrelation function of a time course is characterized by a single exponential decay, as is the case for Brownian noise, the PSD is given by a Lorentzian profile, and thus, well approximated by an inverse-square law in the low-frequency regime. We do not observe a saturation value for the MO circuit, and it is likely not in the frequency window of physiological interest. This may especially be the case for circuits where the correlation times are long.

The noise reduction is in the physiologically relevant low-frequency regime, and in Fig. 4 we have indicated the typ-

**Table 1: Probability rates for positive autogenous circuit**

Category	Symbol	Reaction	Value (s <sup>-1</sup> )	Ref.
protein dimerization	$k_1$	$P_1 + P_1 \rightarrow P_2$	0.001–0.1	[51,52]
	$q_1$	$P_2 \rightarrow P_1 + P_1$	0.1–1	
TF-operator int	$k_{20}$	$P_2 + D00 \rightarrow D20$	0.012	[53-55]
	$q_{20}$	$D20 \rightarrow P_2 + D00$	0.9	
	$k_{21}$	$P_1 + D00 \rightarrow D10$	0.038	
	$q_{21}$	$D10 \rightarrow P_1 + D00$	0.3	
	$k_{22}$	$P_1 + D10 \rightarrow D20$	0.011	
	$q_{22}$	$D20 \rightarrow P_1 + D10$	0.9	
RNAp-promoter int	$k_{30}$	$R + D00 \rightarrow D01$	0.038	[56-58]
	$q_{30}$	$D01 \rightarrow R + D00$	0.3	
	$k_{31}$	$R + D10 \rightarrow D11$	0.038 <sup>†</sup> , 0.38 <sup>‡</sup>	
	$q_{31}$	$D11 \rightarrow R + D10$	0.3 <sup>†</sup> , 0.03 <sup>‡</sup>	
	$k_{32}$	$R + D20 \rightarrow D21$	0.38 <sup>*†</sup>	
	$q_{32}$	$D21 \rightarrow R + D20$	0.03 <sup>*†</sup>	
Isomerization	$\nu$	$Dx1 \rightarrow C + Dx0$	0.0078	[55]
tsx-tsl elongation & decay	$\alpha$	$C \rightarrow M + R$	0.03	[59,60]
	$\beta$	$M \rightarrow P_1 + M$	0.044	
	$\gamma_0$	$M \rightarrow \emptyset$	0.0039	
	$\gamma_1$	$P_1 \rightarrow \emptyset$	$7 \times 10^{-4}$	
	$\gamma_2$	$P_2 \rightarrow \emptyset$	$0.7-3.5 \times 10^{-4}$	

Kinetic rates for the positive autogenous circuit. Experimentally available rates are all taken from lambda phage-*E. coli* complex. The values with superscript correspond to the circuit topologies DA1 (\*), DA2 (†), and DA3 (‡) in Fig. 1.

ical values for a cell cycle and mRNA lifetime. Although stochastic fluctuations impose a fundamental limit in cellular information processing, multiple noise sources may affect cellular physiology non-additively. For a living cell, fluctuations are especially relevant when their correlation time is comparable to, or longer than, the cell cycle. At the same time, short-time scale fluctuations (relative to the cell cycle) are more easily attenuated or do not propagate [28]. Additionally, the observed flat region in the PSD of the DA circuits implies that as far as mid-range frequency fluctuations are concerned, we can safely approximate them as a white noise. This insight may shed light on the reliability of approximation schemes for effective stochastic dynamics in protein-only models.

**Increased lifetime of dimer plays an important role**

The virtue of the cytosolic dimer state is also directly related to the extended lifetime of proteins when in a complex. Except for the degradation tagging for active proteolysis, a much slower turnover of protein oligomers is the norm. This is partly explained by the common observation that monomers have largely unfolded structures, which are prone to be target of proteolysis [29]. It has also been pointed out that the prolonged lifetime of the oligomeric form is a critical factor for enhancing the feasible parameter ranges of gene circuits [30]. As seen from Fig. 3 (also Table 2), the fold change of the noise reduction,

while still significant, is not as strong for the (hypothetical) case of dimer lifetime being the same as that of the monomer ( $\gamma_2/\gamma_1 = 1/2$ ). However, the low-frequency power spectra still exhibit almost an order-of-magnitude smaller noise power than in the MO circuit with the same rate parameters (Fig. 4). Hence, the noise reduction capability holds good as long as the dimer lifetime is kept sufficiently long compared with the monomer-dimer transition.

**Effects of homo-dimerization in genetic toggle switch**

The exceptionally stable lysogeny of the phage  $\lambda$ , for which the spontaneous loss rate is  $\approx 10^{-7}$  per cell per generation [31,32], has motivated the synthesis of a genetic toggle switch [15]. Toggle switch is constructed from a pair of genes, which we will denote as gene A and B, that transcriptionally repress each other's expression. This mutual negative regulation can be considered an effective positive feedback loop and provides the basis for the multiple steady states. The existence of multistability, in turn, may be exploited as a device for epigenetic memory or for decision making [33].

As the general attributes of positive feedback with cooperativity suggest, a genetic toggle switch responds to external cues in an ultrasensitive way: When the strength of a signal approaches a threshold value, the gene expression

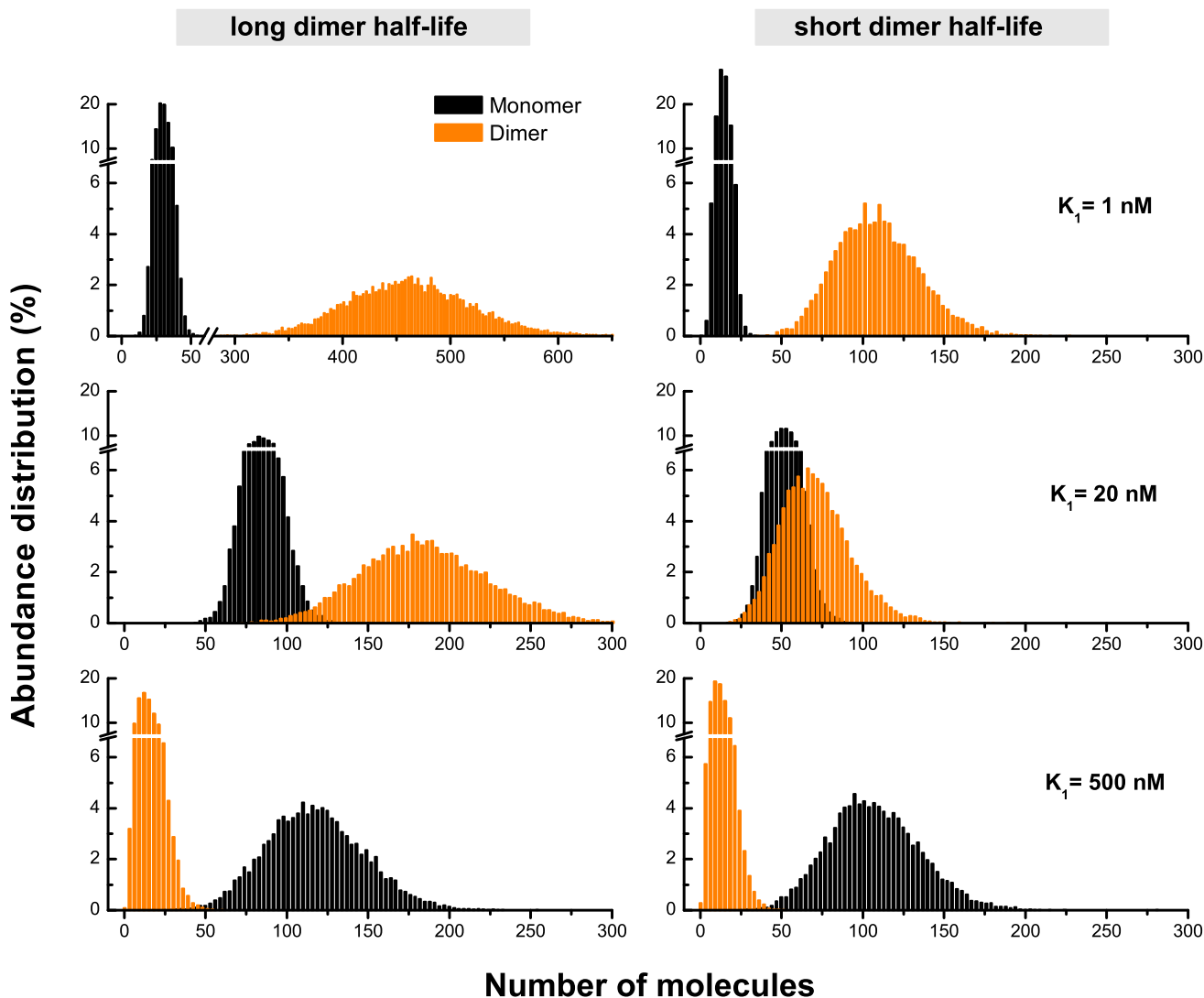
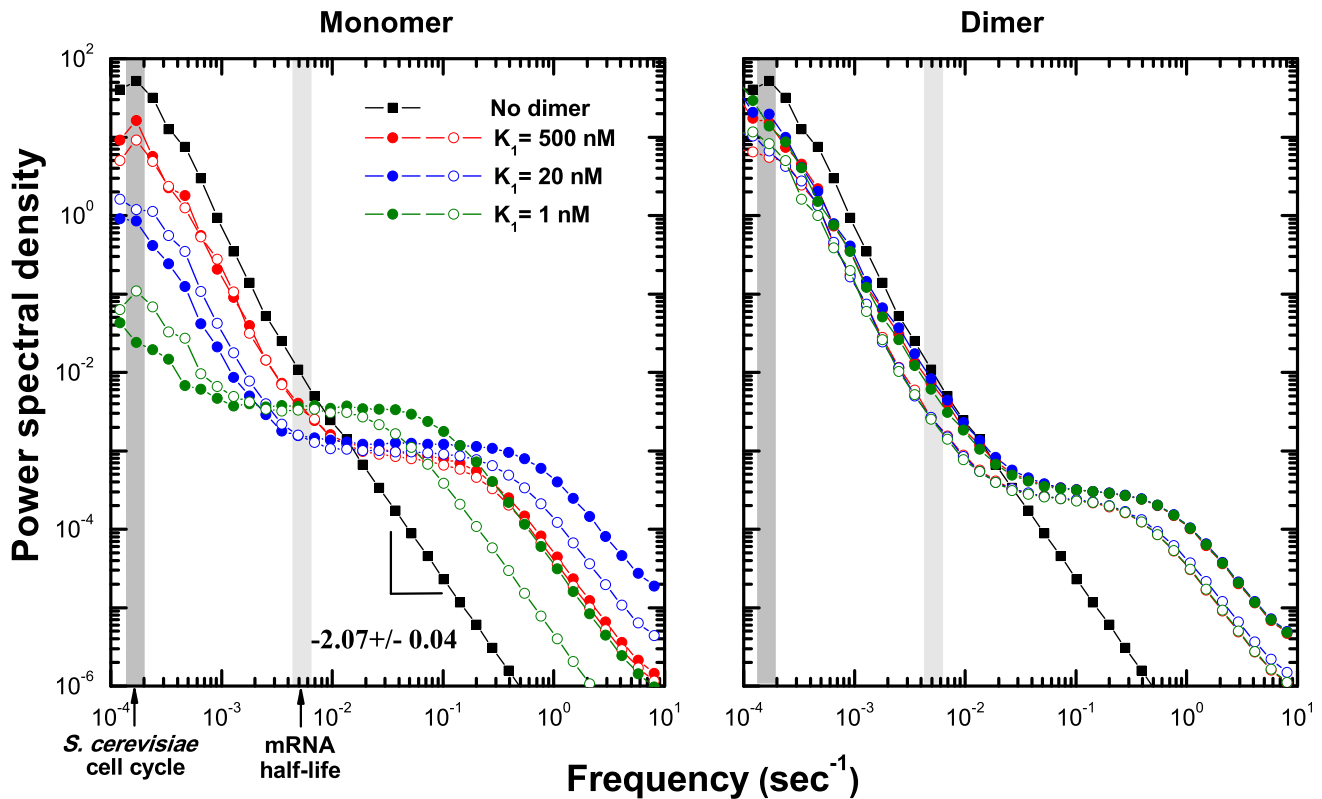

**Figure 3**  
**Stationary state distribution of monomer (black) and dimer (orange) protein abundance in the positive autogenous circuits.** The left (right) column corresponds to a ratio of the dimer and monomer decay rates of  $\gamma_2/\gamma_1 = 1/10$  ( $\gamma_2/\gamma_1 = 1/2$ ). The molecular copy numbers are collected at a fixed time interval ( $5 \cdot 10^3$  sec) after the steady state has been reached. Here  $K_1 \equiv q_1/k_1$  is the dissociation constant of the protein dimer. As the binding equilibrium is shifted towards the dimer state (decreasing  $K_1$ ), the noise level is monotonically reduced (see Table 2). Note that the prolonged protein lifetime due to the complex formation (left column) affects the noise level.

state can be flipped by a small change in the signal. For example, the concentration of protein A (B) may rapidly switch from high to low and vice versa. However, previous studies of a synthetic toggle switch have shown that the noise-induced state switching is a rare event [15,34,35]. In the ensuing analysis, we aim to delineate the origin of this exceptional stability.

In a simple model, the monomer-only (MO) toggle, regulatory proteins only exist in monomeric form. Although

an external signal is not explicitly included, random fluctuations in the abundance of the circuit's molecular components will occasionally flip the toggle-state for the two protein species. Drawing on the results from our analysis of positive autoregulatory gene circuits, we hypothesize that dimerization in the regulatory proteins of the toggle switch will serve to stabilize its performance against noise. We allow the protein products of each gene to form a homodimer, being either AA or BB, which is similar to the cI-cro system in phage  $\lambda$  [36]. The dissociation constant



**Figure 4**  
**Power spectral density (PSD) of fluctuations in protein abundance.** The PSD of the MO circuit clearly displays a power-law behavior. All other model systems with an available cytosolic protein dimer state (DAI shown here) develop a plateau in the mid-frequency region regardless of the model details (see *Supplementary Information*). As the dimer binding affinity increases, the noise level is further reduced. We have included the MO result in the dimer panel (right) for reference. Datasets with solid (empty) symbols correspond to  $\gamma_2/\gamma_1 = 1/10$  ( $\gamma_2/\gamma_1 = 1/2$ ).

for the dimers is defined as  $K_1 = q_1/k_1$ , where  $k_1$  is the rate of two monomers forming a complex, and  $q_1$  the rate of the complex breaking up into its two constituents.

We evaluate the effect of the fast protein binding-unbinding dynamics on the toggle switch performance by using either (i) the monomers or (ii) the homodimers as the functional form of the repressor. Fig. 5 shows, for selected

values of the dissociation constant  $K_1$ , representative time series of the protein monomer (left) and dimer (right) abundances for the case of (a) monomeric or (b) dimeric transcription factors, respectively. A careful analysis of the phase space (in presence of noise) for our chosen set of parameters confirms that the studied toggle-switch systems are in the bistable region [37].

**Table 2: Relative Fano factors of protein abundance distributions**

$K_1$ (nM)	$\gamma_2 = \gamma_1/10$		$\gamma_2 = \gamma_1/2$	
	monomer	dimer	monomer	dimer
1	0.127	0.809	0.132	0.679
20	0.209	0.936	0.230	0.716
500	0.866	0.478	0.826	0.426

The Fano factor of protein abundance distribution for the autogenous circuits (topology DAI), relative to that of the monomer-only (MO) circuit, 8.729.

When monomer is the functional form of the repressor molecule (Fig. 5(a)) and  $K_1$  is large (limit of low dimer affinity), the protein populations are dominated by monomers. Hence, the circuit effectively behaves as an MO toggle. As  $K_1$  decreases, we see that the level of random switching is suppressed: Analogous to the autogenous circuit, the dimer pool stabilizes the protein monomer population. However, the noise suppression is not monotonic with increasing dimer binding affinity. Indeed, for very large binding affinities (small  $K_1$ ), the number of random switching events is increased since the monomer is only available in low copy numbers. Consequently in this limit, it becomes more likely that a small fluctuation in

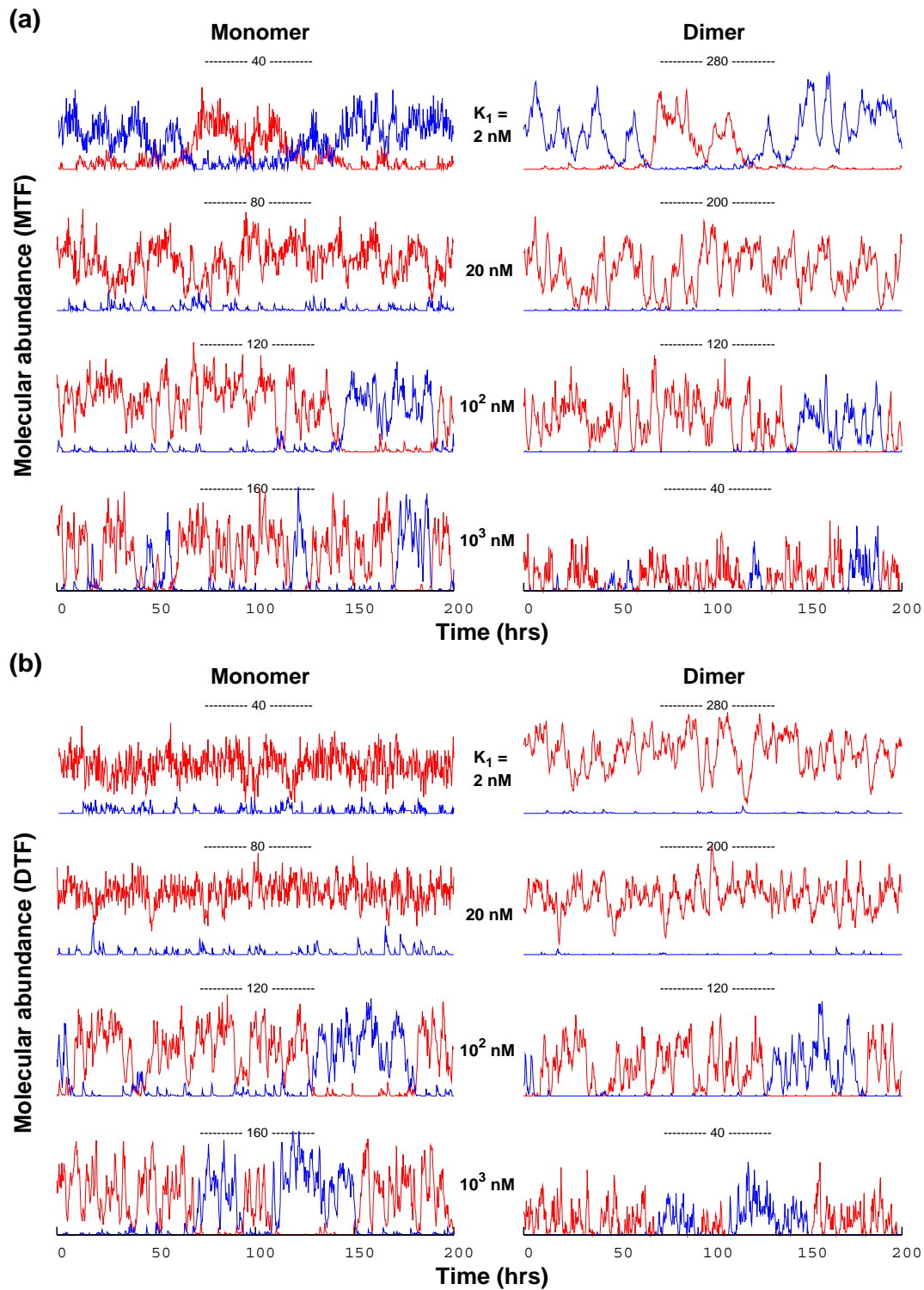

**Figure 5**  
**Sample time series of monomer and dimer copy numbers in genetic toggle switch.** (a) MTF circuit, where monomer is the functional form of the repressor. (b) DTF circuit, where dimer is the functional form of the repressor. The left (right) column shows the number of the two monomer molecules A and B (dimers AA and BB), and the initial state is always with species A (red) in high abundance. Note that the switching frequency depends on the binding affinity of protein dimer.



the monomer abundance can cause a dramatic change in the overall gene expression profile. The noise-stabilizing effect of dimerization is also reflected in the corresponding PSDs [Additional file 1]. For instance, we observe a marked suppression of low-frequency fluctuations in the monomer abundance with increasing  $K_1$ .

In Fig. 5(b) we show corresponding sample time series for the case of a dimeric repressor, all other properties being the same as in (a). While the overall trends are similar, we do note the following difference. Contrary to the monomeric repressor case, there are very few toggle events in the strong binding limit: Since the signaling molecules (dimers) of the dominant gene (the "on"-gene) tend to exist in large copy numbers, a significant fluctuation is needed to

flip the state of the toggle switch. In the case of monomeric repression, the signaling molecule exists in low abundance in this limit. Thus, the dominant protein species in the dimeric-repressor system is able to maintain much better control over the state of the toggle switch.

In Fig. 6, we show the distribution  $(N_A - N_B)$ , the difference in molecule abundance for the two protein species in the case of monomeric (left) and dimeric (right) transcription factor. The asymmetry with respect to the zero axis is caused by our choice of initial conditions (protein species A in high concentration and species B in low concentration), as well as the finite length of the time series. For monomeric transcription, the presence of dimers with moderate binding affinity sharpens the monomer abun-

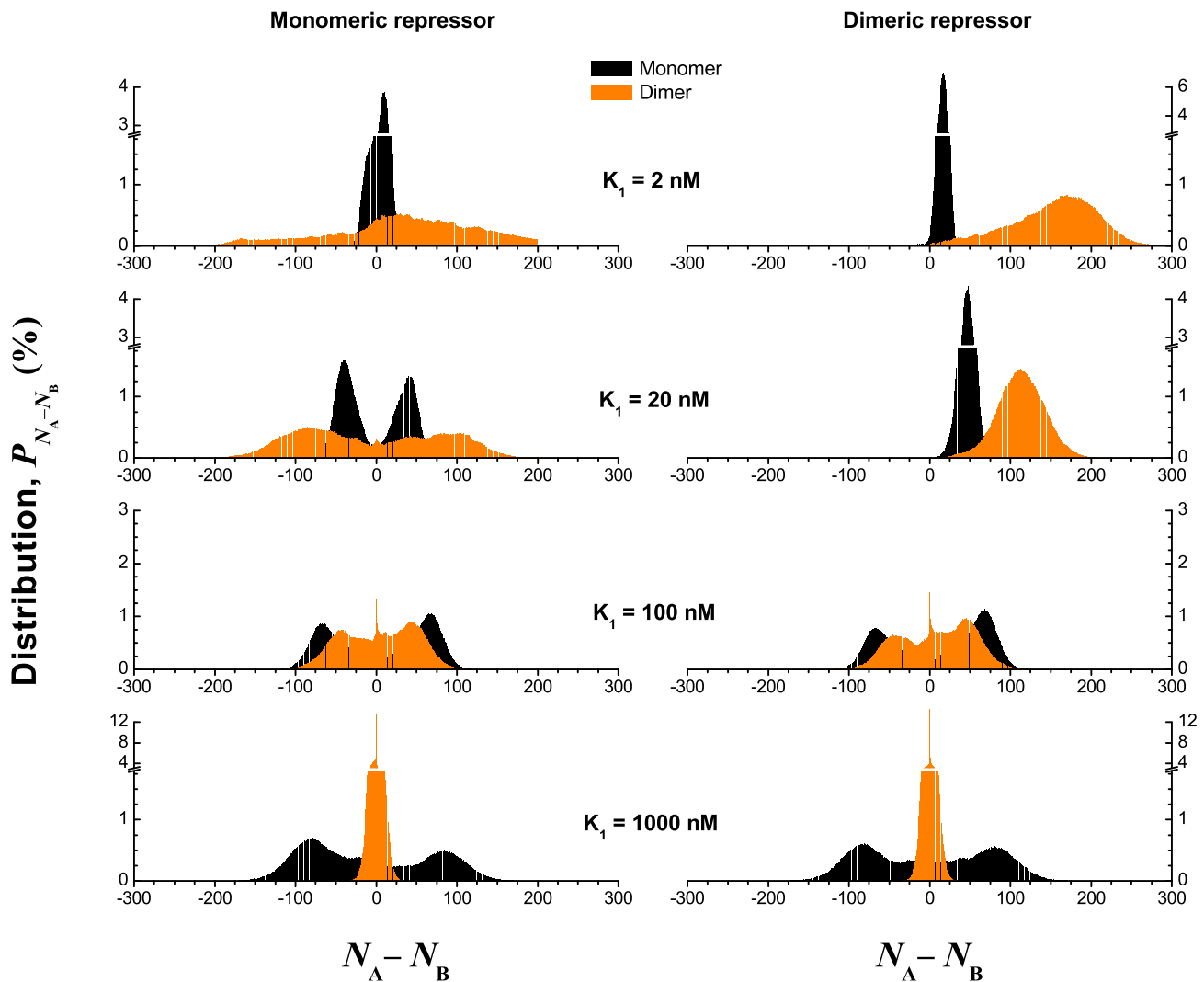

**Figure 6**  
**Distribution of monomer abundance differences between protein species A and B.** The asymmetry with respect to the zero axis is due to the choice of initial state (species A high) and the finite time span of simulations.

dance distribution while accentuating its bimodal character. This is in agreement with the qualitative observation from Fig. 5 on switching stability. For dimeric transcription, we clearly observe that the symmetry of the system is broken for small values of  $K_1$ , indicating that the state of the toggle switch is extremely stable, and hence, likely determined by the choice of the initial conditions.

To systematically quantify our observations on the interplay between dimer-binding affinity and the functional stability of the toggle switch, we generated long time series ( $\approx 3 \cdot 10^7$  sec) to measure the average spontaneous switching rate. In Fig. 7, we show the average toggle frequency relative to that of the MO toggle for the binding affinities  $K_1/nM = \{2, 20, 100, 1000\}$ , and the average MO switching rate is  $7.5 \times 10^{-6}$ /hour. As expected, we find that inter-

mediate values of  $K_1$  are able to stabilize the toggle switch. Fig. 7 also highlights the increased stability of the toggle switch for a dimeric versus monomeric transcription factor, the dimeric switching rates always being lower and approaching zero for strong dimer binding.

**Heterodimerization in genetic toggle switch**

We have also considered the case of heterodimerization in the toggle switch, since the noise- and functional stabilization of the switch may be directly affected by the composition and source of the dimers. Note that, the gene-regulation activity is conferred by the two monomer proteins A and B and not the heterodimer AB. However, we find that the presence of (inactive) heterodimers gives rise to very similar noise-stabilizing effects as that of homodimers (Fig. 7). In fact, the existence of heterodimer

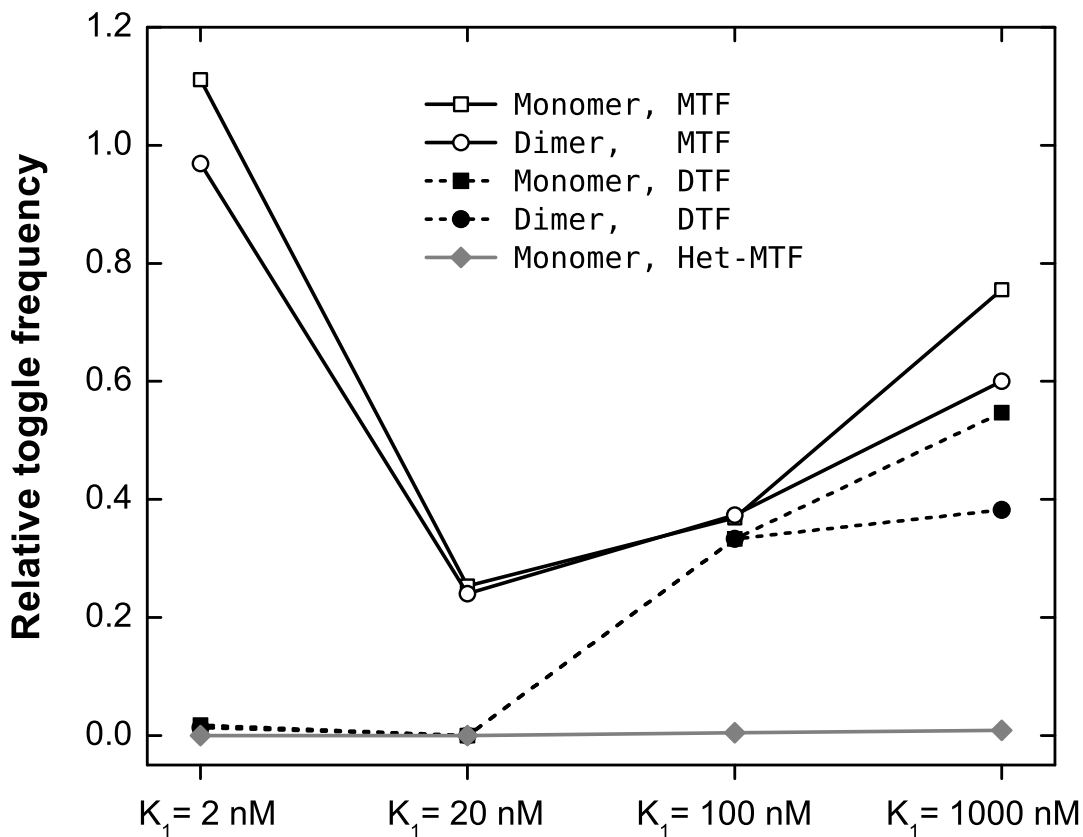

**Figure 7**  
**Random switching rates of genetic toggle switches.** Ordinate is the ratio of the random switching rates of various toggle switches to that of the monomer-only (MO) circuit,  $7.5 \times 10^{-6}$ /hour. MTF, monomeric transcription factor; DTF, dimeric transcription factor; Het-MTF, monomeric transcription factor with deactivated heterodimer state.

state allows the dominant protein species to effectively suppress the (active) monomers of the minority species. Thus the heterodimer circuit shows dramatically enhanced functional stability as compared to the case of homodimeric repressors, not sharing the discussed vulnerability of MO circuit to intrinsic noise. Although, to our knowledge, this is a purely hypothetical toggle-switch design, it provides a general strategy for noise control in synthetic gene circuits, along with previously proposed approach of overlapping upstream regulatory domains [38].

## Conclusion

Cells have evolved distinct strategies to combat the fundamental limits imposed by intrinsic and environmental fluctuations. We investigated the role of protein oligomerization on noise originating from the random occurrence of reaction events and the discrete nature of molecules. Recent efforts to correlate network structure with functional aspects may provide valuable insights into approaches for network-level noise control [39]. While negative feedback is one of the most abundantly observed patterns to achieve the goal of stability, it begs the question of how cells reliably change the expression of genes from one state to another. The ultrasensitive response circuit, exemplified by the ubiquitous signal transduction cascades in eukaryotic cells, has been proposed as an answer to this question [40,41].

In addition to the combinatorial expansion of functional specificity, we argue that the availability of oligomeric states contributes to the attenuation of stochastic fluctuations in protein abundance. In positive autoregulatory gene circuits, where the abundance of an expressed protein controls its own synthesis rate, dimerization provides a buffer serving to mitigate random fluctuations associated with the bursty transcription-translation process. We find that short-time binding-unbinding dynamics reduce the overall noise level by converting potentially pathological low-frequency noise to physiologically unimportant, and easily attenuated, high-frequency noise [28].

Noise-induced switching generally signals a defect in cellular information processing. Untimely exit from latency in the lambda-phage system directly implies, as the immediate consequence to viruses, increased chance of being targeted by a host immune system. In the case of a bacterium, the expression of a specific set of sugar uptake genes when the sugar is absent from the external medium is a considerable waste of cellular resources. For example, *lac* operon of *E. coli* can be considered to have the circuitry of mutual antagonism between the *lacI* gene and lactose uptake-catabolic genes [42]. A difference lies in the non-transcriptional deactivation of the allosteric transcription factor *LacI*. *LacY*, lactose permease, indirectly regulates

*LacI* by increasing lactose uptake, which in turn catalytically deactivates *LacI*. Likewise, many pili operons of Gram-negative bacteria are also known to utilize heritable expression states, which are of crucial role in pathogenesis [43,44].

We expect that the random flipping of gene expression states in the examples of positive-feedback-based genetic switches may very well be closely coupled with the fitness of an organism. Phenomenological models relating the fitness of an organism to random phenotypic switching in fluctuating environments have provided important insights into the role of noise [45], but still many questions remain unanswered. Applying these insights to the design of a synthetic gene switch demonstrates the potential use of affinity-manipulation for synthetic biology, where the construction of genetic circuits with tunable noise-resistance is of central importance. In particular, our analysis highlights the potential utility of heterodimerization to stabilize ultrasensitive switches against random fluctuations. In practice, small ligand molecules may be employed to regulate and tune the binding affinity of regulatory proteins, being either monomers or dimers. Our results further suggest that the structure of the protein-interaction network [33] may provide important insights on methods for genome-level noise control in synthetic and natural systems.

## Methods

### Model construction

To evaluate the general role of protein oligomerization in a broad functional context, we studied the two most common motifs found in genetic regulatory circuits: positive autoregulation and the bistable switch. The reaction scheme studied is summarized in Fig. 1, where the binding/unbinding reactions between RNAP and promoter or between TF and operator are made explicit. Each distinct binding status of DNA is associated with a unique transcription initiation rate, and then the overall rate of mRNA synthesis is a weighted average of the initiation rates for distinct binding status, where the weights are given by the relative abundance of each configuration at equilibrium, determined by the calculation of binding energy [46]. Note that, neither binding equilibrium nor empirical Hill-type cooperativity is assumed *ad hoc*. In particular, we split the lumped transcription process into two separate events, (i) isomerization of closed RNAP-promoter complex to its open form and (ii) transcription elongation followed by termination. This is to reflect the availability of the free promoter while the transcription machinery proceeds along the coding sequence of a gene as soon as the promoter region is cleared of the RNAP holoenzyme. Otherwise, the promoter would be inaccessible during a whole transcription event, altering the random mRNA synthesis dynamics.

To realize the genetic toggle switch in a stochastic setting, we keep track of the microscopic origin of cooperativity that gives rise to bistability. Among various strategies, we employ multiple operator sites which have the same binding affinity with the repressor. The resultant circuitry is, in essence, two autogenous circuits, *A* and *B*, which are connected through the active form of their expressed proteins (the active form being either monomer or dimer). The connection is implemented by allowing the active form of proteins *A* (*B*) to bind the operator sites of gene *B* (*A*). In order to make the interaction between the two genes repressive, unlike positive autogenous circuits,  $K_{31}$  and  $K_{32}$  in Fig. 1 are now greater than  $K_{30}$ , making the protein transcriptional repressors. For reasons of analytical simplicity, we have studied the symmetric toggle switch, where the reaction descriptions of each component follow those of the autogenous circuit. Again, the quantitative characteristics of macromolecular binding-unbinding are chosen based on the phage lambda-*E. coli* system. The only exception is related to the multiple operator sites, where the second repressor binds an operator site with higher binding affinity when the first site is already occupied by the repressor protein [47]. We introduce three different dimerization schemes. Three different dimerization scheme have been introduced: (i) homodimerization with monomeric repressor, (ii) homodimerization with dimeric repressor, and (iii) heterodimerization with monomeric repressor. By solving for the stationary states of the deterministic rate equations, we could identify the bistability region in parameter space to which all the model systems under consideration belong.

### Stochastic simulation

While the deterministic rate equation approach or Langevin dynamics explicitly gives the time-evolution of molecular concentration in the form of ordinary differential equations, chemical master equation (CME) describes the evolution of a molecular number state as a continuous-time jump Markov process. To generate the statistically correct trajectories dictated by CME, we used the Gillespie direct [48] and Next Reaction (Gibson-Bruck) [49] algorithms, both based on the exact chemical master equation. The Dizzy package [50] were used as the core engine of the simulations. To ensure that calculations were undertaken in a steady state, we solved the deterministic set of equations for steady state using every combination of parameters investigated. We employed these deterministic steady-state solutions as initial conditions for the stochastic simulations. For each model system, we generated  $10^5$  ensemble runs with identical initial conditions and used the instantaneous protein copy number at a fixed time point  $t = 5000$  sec. To achieve high-quality power spectra in the low- and high-frequency limits, we ran time courses ( $\sim 10^5$  sec) with higher sampling frequency (20 measure points per sec).

To calculate the average switching rate, we generated time series of minimum length  $3 \cdot 10^7$  sec (approximately corresponding to 1 year). We identify a state change in the toggle switch by monitoring the ratio of the monomer and dimer abundance for the two protein species. In order to avoid counting short-time fluctuations that do not correspond to a prolonged change of the toggle state, we applied sliding-window average to the time series, using a window size of 1000 sec.

### Authors' contributions

CMG and EA designed the study. CMG performed the computations. CMG and EA analyzed the results and wrote the paper. Both authors have read and approved the final version of the paper.

### Additional material

#### Additional file 1

Supplementary results for the positive autoregulatory circuits with various topology. Protein abundance distribution and power spectral density of autogenous DA2 and DA3 circuits are presented.

Click here for file

[<http://www.biomedcentral.com/content/supplementary/1752-0509-2-94-S1.pdf>]

### Acknowledgements

The authors thank Dr. Navid for thoughtful discussion and suggestions. This work was performed under the auspices of the U. S. Department of Energy by Lawrence Livermore National Laboratory under Contract DE-AC52-07NA27344 and funded by the Laboratory Directed Research and Development Program (project 06-ERD-061) at LLNL.

### References

1. Pedraza J, van Oudenaarden A: **Noise Propagation in Gene Networks.** *Science* 2005, **307(5717)**:1965-1969.
2. Rosenfeld N, Young J, Alon U, Swain P, Elowitz M: **Gene Regulation at the Single-Cell Level.** *Science* 2005, **307(5717)**:1962-1965.
3. Newman J, Ghaemmaghami S, Ihmels J, Breslow D, Noble M, DeRisi J, Weissman J: **Single-cell proteomic analysis of *S. cerevisiae* reveals the architecture of biological noise.** *Nature* 2006, **441**:840-846.
4. Raser J, O'Shea E: **Noise in Gene Expression: Origins, Consequences, and Control.** *Science* 2005, **309(5743)**:2010-2013.
5. Guptasarma P: **Does replication-induced transcription regulate synthesis of the myriad low copy number proteins of *Escherichia coli*?** *Bioessays* 1995, **17(11)**:987-97.
6. Nelson N: **Metal ion transporters and homeostasis.** *The EMBO Journal* 1999, **18**:4361-4371.
7. Kussel E, Leibler S: **Phenotypic diversity, population growth, and information in fluctuating environments.** *Science* 2005, **309(5743)**:2075-2078.
8. Chen B, Wang Y: **On the attenuation and amplification of molecular noise in genetic regulatory networks.** *BMC Bioinformatics* 2006, **7**:52.
9. Thieffry D, Huerta A, Pérez-Rueda E, Collado-Vides J: **regulation in *Escherichia coli*.** *BioEssays* 1998, **20**:433-440.
10. Thattai M, van Oudenaarden A: **Attenuation of Noise in Ultrasensitive Signaling Cascades.** *Biophys J* 2002, **82(6)**:2943-2950.
11. Yi T, Huang Y, Simon M, Doyle J: **Robust perfect adaptation in bacterial chemotaxis through integral feedback control.** *Proc Natl Acad Sci USA* 2000, **97(9)**:4649.

12. Vilar J, Kueh H, Barkai N, Leibler S: **Mechanisms of noise-resistance in genetic oscillators.** *Proc Natl Acad Sci USA* 2002, **99(9)**:5988.
13. Semsey S, Andersson A, Krishna S, Jensen M, Masse E, Sneppen K: **Genetic regulation of fluxes: iron homeostasis of Escherichia coli.** *Nucleic Acids Research* 2006, **34(17)**:4960.
14. Levine E, Zhang Z, Kuhlman T, Hwa T: **Quantitative Characteristics of Gene Regulation by Small RNA.** *PLoS Biol* 2007, **5(9)**:e229.
15. Gardner T, Cantor C, Collins J: **Construction of a genetic toggle switch in Escherichia coli.** *Nature* 2000, **403(6767)**:339-42.
16. Beckett D: **Regulated assembly of transcription factors and control of transcription initiation.** *J Molecular Biology* 2001, **314(3)**:335-352.
17. Kim B, Little J: **Dimerization of a specific DNA-binding protein on the DNA.** *Science* 1992, **255(5041)**:203-206.
18. Berger C, Piubelli L, Haditsch U, Bosshard H: **Diffusion-controlled DNA recognition by an unfolded, monomeric bZIP transcription factor.** *FEBS Letters* 1998, **425**:14-18.
19. Kohler J, Metallo S, Schneider T, Schepartz A: **DNA specificity enhanced by sequential binding of protein monomers.** *Proc Natl Acad Sci USA* 1999, **96(21)**:11735-11739.
20. Rentzperis D, Jonsson T, Sauer R: **Acceleration of the refolding of Arc repressor by nucleic acids and other polyanions.** *Nature Structural Biology* 1999, **6**:569-573.
21. Bundschuh R, Hayot F, Jayaprakash C: **The Role of Dimerization in Noise Reduction of Simple Genetic Networks.** *J Theor Biol* 2003, **220(2)**:261-269.
22. Alarcón T, Page K: **Stochastic models of receptor oligomerization by bivalent ligand.** *J R Soc Interface* 2006, **3**:545-559.
23. Macnamara S, Burrage K, Sidje RB: **Stochastic analysis of the VEGF receptor response curve.** In *Computational Models for Life Sciences-CMLS'07* Edited by: Pham TD, Zhou X. American Institute of Physics; 2007.
24. Ispolatov I, Yuryev A, Mazo I, Maslov S: **Binding properties and evolution of homodimers in protein-protein interaction networks.** *Nucleic Acids Research* 2005, **33(11)**:3629-3635.
25. Ramirez F, Schlicker A, Assenov Y, Lengauer T, Albrecht M: **Computational analysis of human protein interaction networks.** *Proteomics* 2007, **7**:2541-2552.
26. McDermott J, Bumgarner R, Samudrala R: **Functional annotation from predicted protein interaction networks.** *Bioinformatics* 2005, **21(15)**:3217-3226.
27. Press WH, Teukolsky SA, Vetterling WT, Flannery BP: *Numerical Recipes* Cambridge University Press; 1992.
28. Tan C, Reza F, You L: **Noise-limited frequency signal transmission in gene circuits.** *Biophys J* 2007, **93**:3753-3761.
29. Herman C, Prakash S, Lu C, Matouschek A, Gross C: **Lack of a Robust Unfoldase Activity Confers a Unique Level of Substrate Specificity to the Universal AAA Protease FtsH.** *Molecular Cell* 2003, **11(3)**:659-669.
30. Buchler N, Gerland U, Hwa T: **Nonlinear Protein Degradation and the Function of Genetic Circuits.** *Proc Natl Acad Sci USA* 2005, **102(27)**:9559-9564.
31. Rozanov D, D'Ari R, Sineoky S: **RecA-independent pathways of lambda prophage induction in Escherichia coli.** *J Bacteriology* 1998, **180(23)**:6306-6315.
32. Little J, Shepley D, Wert D: **Robustness of a gene regulatory circuit.** *EMBO Journal* 1999, **18**:4299-4307.
33. Losick R, Desplan C: **Stochasticity and Cell Fate.** *Science* 2008, **320(5872)**:65.
34. Kobayashi H, Kaern M, Araki M, Chung K, Gardner T, Cantor C, Collins J: **Programmable cells: Interfacing natural and engineered gene networks.** *Proc Natl Acad Sci USA* 2004, **101(22)**:8314-8419.
35. Tian T, Burrage K: **Stochastic models for regulatory networks of the genetic toggle switch.** *Proc Natl Acad Sci USA* 2006, **103(22)**:8372-8377.
36. Ptashne M: *A Genetic Switch: Gene Control and Phage lambda* Cold Spring Harbor Laboratory Press, Cambridge, MA; 1986.
37. Ghim CM, Almaas E: **Two-Component Genetic Switch as a Synthetic Module with Tunable Stability.** in press.
38. Warren P, ten Wolde P: **Enhancement of the stability of genetic switches by overlapping upstream regulatory domains.** *Phys Rev Lett* 2004, **92(12)**:128101.
39. Barabasi A, Oltvai Z: **Network biology: understanding the cell's functional organization.** *Nature Reviews Genetics* 2004, **5(2)**:101-113.
40. Goldbeter A, Koshland D: **An Amplified Sensitivity Arising from Covalent Modification in Biological Systems.** *Proc Natl Acad Sci USA* 1981, **78(11)**:6840-6844.
41. Huang C, Ferrell J Jr: **Ultrasensitivity in the mitogen-activated protein kinase cascade.** *Proc Natl Acad Sci USA* 1996, **93(19)**:10078-83.
42. Müller-Hill B: *The Lac Operon: A Short History of a Genetic Paradigm* Walter de Gruyter; 1996.
43. Hernday A, Krabbe M, Braaten B, Low D: **Self-perpetuating epigenetic pili switches in bacteria.** *Proc Natl Acad Sci USA* 2002, **99**:16470-16476.
44. Sauer F, Mulvey M, Schilling J, Martinez J, Hultgren S: **Bacterial pili: molecular mechanism of pathogenesis.** *Curr Op Microbiol* 2000, **3**:65-72.
45. Thattai M, van Oudenaarden A: **Stochastic gene expression in fluctuating environment.** *Genetics* 2004, **167**:523-530.
46. Gilman A, Arkin A: **Genetic Code: Representations and Dynamical Models of Genetic Components and Networks.** *Annual Reviews in Genomics and Human Genetics* 2002, **3**:341-369.
47. Tian T, Burrage K: **Bistability and switching in the lysis/lysogeny genetic regulatory network of bacteriophage lambda.** *Journal of Theoretical Biology* 2004, **227(2)**:229-237.
48. Gillespie D: **Exact stochastic simulation of coupled chemical reactions.** *J Phys Chem* 1977, **81(25)**:2340-2361.
49. Gibson M, Bruck J: **Efficient exact stochastic simulation of chemical systems with many species and many channels.** *J Phys Chem A* 2000, **104(9)**:1876-1889.
50. Ramsey S, Orrell D, Bolouri H: **Dizzy: stochastic simulation of large-scale genetic regulatory networks.** *J Bioinform Comput Biol* 2005, **3(2)**:415-436.
51. Sauer R: **Molecular characterization of the lambda repressor and its gene I.** In *PhD thesis* Dept. of Biochemistry and Molecular Biology, Harvard University; 1979.
52. Arkin A, Ross J, McAdams H: **Stochastic Kinetic Analysis of Developmental Pathway Bifurcation in Phage lambda-Infected Escherichia coli Cells.** *Genetics* 1998, **149(4)**:1633-1648.
53. Ackers G, Johnson A, Shea M: **Quantitative model for gene regulation by lambda phage repressor.** *Proc Natl Acad Sci USA* 1982, **79(4)**:1129.
54. Hawley D, McClure W: **Mechanism of activation of transcription initiation from the lambda PRM promoter.** *J Mol Biol* 1982, **157(3)**:493-525.
55. Hawley D, Johnson A, McClure W: **Functional and physical characterization of transcription initiation complexes in the bacteriophage lambda OR region.** *J Biol Chem* 1985, **260(14)**:8618-8626.
56. deHaseth PL, Zupancic ML, Record MT: **RNA Polymerase-Promoter Interactions: the Comings and Goings of RNA Polymerase.** *J Bacteriol* 1998, **180(12)**:3019-3025.
57. Ujvari A, Martin C: **Thermodynamic and kinetic measurements of promoter binding by T7 RNA polymerase.** *Biochem* 1996, **35(46)**:14574-14582.
58. Shea M, Ackers G: **The OR control system of bacteriophage lambda. A physical-chemical model for gene regulation.** *J Mol Biol* 1985, **181(2)**:211-30.
59. Alberts B, Johnson A, Lewis J, Raff M, Roberts K, Walter P: *Molecular biology of the cell* 4th edition. Garland Science, New York, US; 2002.
60. Lewin B: *Genes VIII* Pearson Prentice Hall Upper Saddle River, NJ; 2004.