

# The Site of the Stimulatory Action of Vasopressin on Sodium Transport in Toad Bladder

MORTIMER M. CIVAN and HOWARD S. FRAZIER

From the Departments of Medicine, Harvard Medical School, the Massachusetts General Hospital, and the Beth Israel Hospital, Boston, Massachusetts 02215

**ABSTRACT** Vasopressin increases the net transport of sodium across the isolated urinary bladder of the toad by increasing the mobility of sodium ion within the tissue. This change is reflected in a decreased DC resistance of the bladder; identification of the permeability barrier which is affected localizes the site of action of vasopressin on sodium transport. Cells of the epithelial layer were impaled from the mucosal side with glass micropipettes while current pulses were passed through the bladder. The resulting voltage deflections across the bladder and between the micropipette and mucosal reference solution were proportional to the resistance across the entire bladder and across the mucosal or apical permeability barrier, respectively. The position of the exploring micropipette was not changed and vasopressin was added to the serosal medium. In 10 successful impalements, the apical permeability barrier contributed 54% of the initial total transbladder resistance, but 98% of the total resistance change following vasopressin occurred at this site. This finding provides direct evidence that vasopressin acts to increase ionic mobility selectively across the apical permeability barrier of the transporting cells of the toad bladder.

## INTRODUCTION

When the urinary bladder of the toad, *Bufo marinus*, is bathed by solutions containing  $\text{Na}^+$ , the addition of vasopressin regularly causes a stimulation in the active transport of  $\text{Na}^+$  from the mucosal to the serosal medium (8, 9). A variety of experimental approaches has provided evidence that the hormonal effect occurs at a mobility barrier early in the transport process, perhaps at the mucosal or apical face of the epithelial cell, and does not directly affect the step in transport at which metabolic energy production is coupled to the process (2, 5, 6, 11). The hormonal effect on transport of  $\text{Na}^+$  is regularly associated with a decrease in the DC resistance of the bladder (2). The present study was undertaken in order to determine directly the site of action of vasopressin on transport of  $\text{Na}^+$  by localizing the region within the epithelial cell where vasopressin has its characteristic effect upon the resistance.

The resistances of the apical and basal aspects of individual bladder cells were measured by means of a micropipette before and during the onset of vasopressin-induced stimulation of transport. The results show that in the untreated state approximately half of the total resistance of the bladder is local-

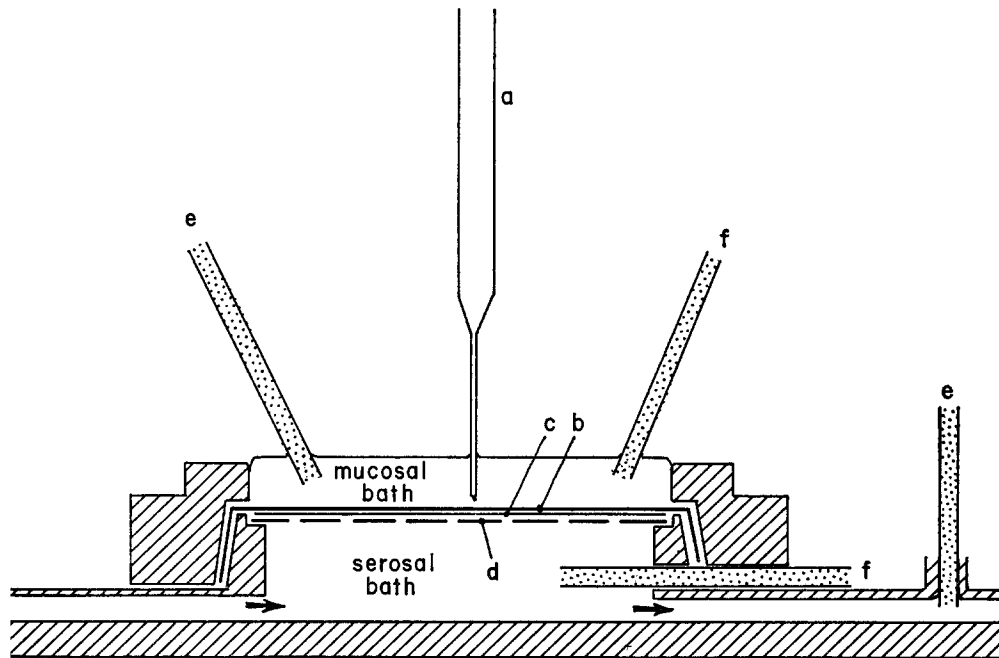

FIGURE 1. Chamber. The exploring micropipette (*a*) was advanced into the bladder (*b*) which was supported from the serosal side by a Millipore filter (*c*) of  $8\ \mu$  pore diameter and a fenestrated stainless steel disc (*d*). Current pulses were passed across the tissue by means of 3 M KCl-agar bridges (*e*). The electrical potential difference between serosal bathing solution and reference mucosal solution was monitored through similar 3 M KCl-agar bridges (*f*). Arrows denote direction of fluid flow.

ized in the apical permeability barrier, but that essentially all of the fall in resistance across the tissue which follows vasopressin administration is localized to this site.

#### METHODS

Female specimens of the toad, *Bufo marinus*, obtained from the Dominican Republic (National Reagents, Inc., Bridgeport, Conn.), were kept on moist earth and force-fed meal worms once weekly. Animals were doubly pithed and half-bladders were excised and mounted, mucosal surface up, on a Lucite chamber with an area of  $4.9\ \text{cm}^2$  (Fig. 1). The preparations received mechanical support from a fenestrated stainless steel disc and overlying Millipore® filter. Pressure in the serosal chamber was reduced 10 cm Hg below atmospheric in order to hold the bladder against the Milli-

pore filter and thus reduce the movement due to spontaneous contractions of the smooth muscle of the bladder. The serosal medium was aerated and recirculated from a reservoir of approximately 100 ml. The mucosal medium was unstirred and was replaced periodically. A total of 10 successful impalements was performed during the months of July through December.

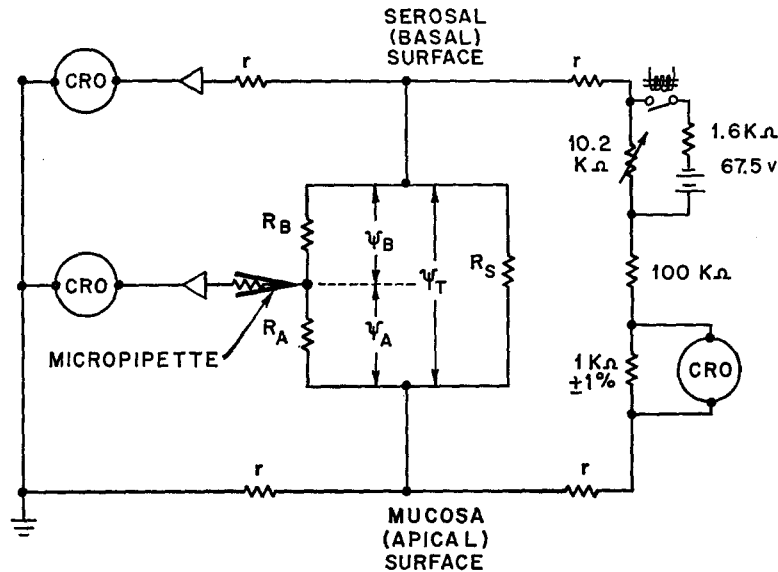

FIGURE 2. Equivalent circuit of bladder and apparatus.  $R_A$  and  $R_B$  are the DC resistances of the apical and basal permeability barriers of the vasopressin-sensitive pathway of  $\text{Na}^+$  transport.  $\psi_A$  and  $\psi_B$  are the spontaneous potentials across these barriers,  $\psi_T$  is the spontaneous potential across the entire tissue. Batteries equivalent to the sources of these potentials, as well as membrane capacitances, have been omitted for simplicity.  $R_S$  is the resistance of the shunt pathway across the tissue. Electrical contact with the preparation is made via the micropipette or 3 M KCl-agar bridges represented by  $r$ . The triangles represent preamplifiers. Depolarizing pulses of current were passed across the tissue using a battery in series with a 100 kohm resistor and a 1000 ohm precision resistor. The latter resistance was used to monitor the magnitude of the current pulse. Since the resistance of the bladder was less than 1000 ohms, the current pulse remained constant despite changes in the resistance of the tissue after vasopressin administration.

The experiments were carried out with symmetrical bathing solutions of the following composition:  $\text{Na}^+$  113.7,  $\text{K}^+$  3.4,  $\text{Cl}^-$  112.8,  $\text{HCO}_3^-$  2.3,  $\text{Ca}^{++}$  0.9,  $\text{HPO}_4^-$  1.7, and  $\text{H}_2\text{PO}_4^-$  0.3 mM. The solution had a pH of 7.6 and a tonicity of 216 milliosmols/kg  $\text{H}_2\text{O}$ . In the first two experiments, the KCl concentration was increased to 30 mM, with an equivalent reduction in NaCl, in order to quell smooth muscle activity. High  $\text{K}^+$  solutions were subsequently found to be unnecessary and the remaining eight experiments were performed with the standard Ringer solution.

The impalements were carried out by means of Ling-Gerard micropipettes (12) of borosilicate glass which had been formed on a model M-1 micropipette puller

(Industrial Science Associates, Inc., Ridgewood, N. Y.). The tip potentials were less than 6 mv and the resistance of the pipettes ranged from 8 to 49 megohms. An electron micrograph of one such pipette demonstrated an outer tip diameter of  $0.2 \mu$  and an included angle of  $6^\circ$  at the tip.

A schematic diagram of selected electrical features of the apparatus and the tissue

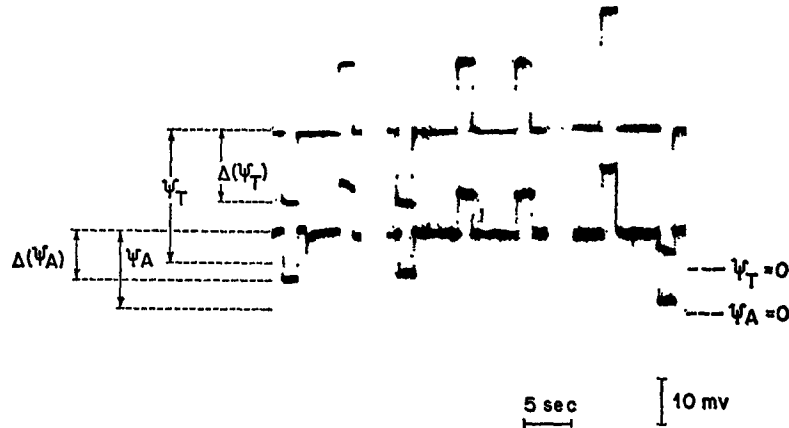

FIGURE 3. Current-voltage relationship across apical permeability barrier and across entire tissue. The response of the transepithelial and transapical potential differences to a depolarizing and to a hyperpolarizing pulse of  $48 \mu\text{amp}$  is shown on the left. The record was obtained 2 hr before the addition of vasopressin to the serosal medium. The response of the same tissue to pulses of  $48$  and  $82 \mu\text{amp}$  is shown at the right. The second record was obtained at the peak of the hormonal effect, 16 min after the first changes could be detected. Smooth muscle contractions had dislodged several micropipettes in the interim; since the electrical potential and resistance profile had not been monitored during the course of the vasopressin effect, the data from this experiment have not been included in Table I. The similarity of the pre- and posttreatment records is a fortuitous result of the change in the electrical characteristics of the tissue during the long interval between the records. In comparison with the measurements immediately prior to the hormonal effect, vasopressin caused an 18% increase in potential and a 16% decrease in resistance. The current-voltage relationship is seen to be linear across the entire tissue and across the apical membrane both before and after the addition of vasopressin, over the range of applied currents.

is shown in Fig. 2. The electrical potential difference across the entire bladder,  $\psi_T$ , was measured with chlorided silver electrodes which were connected to the chamber by salt bridges,  $r$ , of 3 M KCl-agar in tapered polyethylene tubing. One of the electrodes was grounded; the other served as input to a preamplifier having  $10^{13}$  ohms input impedance and  $2 \times 10^{-13}$  amp offset current (Picometric model 181, Instrumentation Laboratory, Inc., Watertown, Mass.). The electrical potential difference between a chlorided silver wire in a Ling-Gerard micropipette and ground,  $\psi_A$ , the potential difference across the apical surface of the cell, was fed into a second Picometric preamplifier. The outputs of the two preamplifiers were connected to the two beams of an oscilloscope (Tektronix model 502 A, Tektronix, Inc., Beaverton,

Oreg.) (Fig. 2). The oscilloscopic display was photographed, and all measurements were made from enlargements.

Depolarizing pulses approximately 2 sec in duration were applied across the bladder from a constant current generator via the salt bridges,  $r$ , in the mucosal and serosal fluid compartments of the chamber. The choice of amplitude for the current pulse was not critical, since the current-voltage relationship of the bladder is linear well beyond the range of transepithelial potential differences seen in this study (3, 7), and the current-voltage relationship across the apical permeability barrier and across the entire tissue both before and after vasopressin appeared to be linear over the range of potential differences in the present experiments (Fig. 3). The magnitude of the current pulse was determined at intervals by observing the voltage deflection across a 1,000 ohm precision resistor in series with the generator output. A pulse was chosen which gave easily measurable voltage deflections across the tissue, but which did not exceed the spontaneous transbladder potential; once selected, the magnitude of the current pulse was held constant throughout a given impalement. Because of the constancy of the current pulse, the magnitude of the resulting voltage deflection produced across any permeability barrier in the bladder was considered to maintain a constant relation to the value of its DC resistance during the course of an experiment. The basis for this inference will be considered below. The relative contributions to the total transbladder resistance of the permeability barriers in front of and behind the micropipette tip were measured by recording during a current pulse the voltage deflections across the entire bladder and across the apical permeability barrier which lay behind the micropipette tip. The ratio of the voltage deflection between micropipette and mucosal solution,  $\Delta(\psi_A)$ , to that seen across the entire tissue,  $\Delta(\psi_T)$ , in response to a current pulse was taken to be the fractional resistance of the apical barrier. One minus this ratio was the fractional resistance across the basal permeability barrier.

The relationships among these measured quantities are summarized in the following equations, in which the spontaneous potentials across the entire bladder, the apical, and the basal permeability barriers are given by  $\psi_T$ ,  $\psi_A$ , and  $\psi_B$ , respectively. The magnitude of the voltage deflection noted at these sites during a pulse from the constant current generator is designated as  $\Delta(\psi_T)$ ,  $\Delta(\psi_A)$ , and  $\Delta(\psi_B)$ , respectively, and is proportional to the DC resistance across the appropriate portion of the preparation.

$$\psi_T = \psi_A + \psi_B \quad (1)$$

$$\Delta(\psi)_T = \Delta(\psi_A) + \Delta(\psi_B) \quad (2)$$

From (2) it follows that

$$1 = \Delta(\psi_A)/\Delta(\psi_T) + \Delta(\psi_B)/\Delta(\psi_T) \quad (3)$$

As an additional check on the method, the potential difference between the micropipette and a serosal, rather than mucosal, reference electrode was monitored in four experiments. In this circumstance, the fractional resistance of the apical permeability barrier is given by  $1 - \Delta(\psi_B)/\Delta(\psi_T)$  where  $\Delta(\psi_B)$  is the voltage deflection across

the basal permeability barrier which lies ahead of the micropipette tip. In one experiment the relative resistances of both apical and basal permeability barriers were measured during the course of the same impalement and hormonal response. When converted to an equivalent form, both types of recording gave equivalent results. In order to simplify the presentation, our results will be described as if the observation of  $\Delta(\psi_A)$  had been made in all experiments.

Once a cell was entered, the micropipette was not moved and the transbladder potential difference and resistance and the fractional resistance across the apical barrier were determined at intervals. Vasopressin (Pitressin®, Parke, Davis and Company, Detroit, Mich.) was then added to the serosal reservoir to yield final concentrations in excess of 30 mU/ml and observation of the potential and resistance profile of the bladder was continued.

## RESULTS

### 1. *The Position of the Micropipette Tip*

In each experiment, the voltage difference between the micropipette and mucosal reference solution,  $\psi_A$ , was close to zero before the micropipette entered the tissue. In addition, passage of a current pulse from the constant current generator across the bladder elicited no change, or a very small one, in  $\psi_A$ . When the micropipette was advanced into the tissue, the first stable potential change in  $\psi_A$ , the potential difference between micropipette tip and mucosal reference point, was positive and the current pulse produced a significant deflection in the trace. With further advance of the micropipette,  $\psi_A$  increased further and became equal to the total transbladder potential,  $\psi_T$ . With the micropipette in this position, a current pulse elicited equal voltage deflections in the oscilloscope traces recording  $\psi_A$  and  $\psi_T$ , that is  $\Delta(\psi_A)$  equaled  $\Delta(\psi_T)$ . Usually two or three positive potential steps were observed on advancement of the micropipette. In no case was the potential profile found to be a continuous function of distance except when the micropipette tip was broken during advancement, as evidenced by a marked fall in the resistance of the pipette.

The epithelial cell layer of the toad bladder is only 3–10  $\mu$  thick (14), and spontaneously active smooth muscle is present on its serosal surface. These circumstances made it difficult to maintain the micropipette tip in a stable position within a single cell for prolonged periods. Two criteria were established to determine whether the tip had shifted position during the course of an experiment. An abrupt change in either the potential difference,  $\psi_A$ , or the resistance between the micropipette tip and the mucosal solution, here given by  $\Delta(\psi_A)$ , without a concurrent change across the entire tissue, was taken to mean that the position of the micropipette tip had shifted. Similarly, if the fractional resistance of either the apical or basal permeability barrier increased abruptly at a time when transbladder resistance was decreasing, movement of

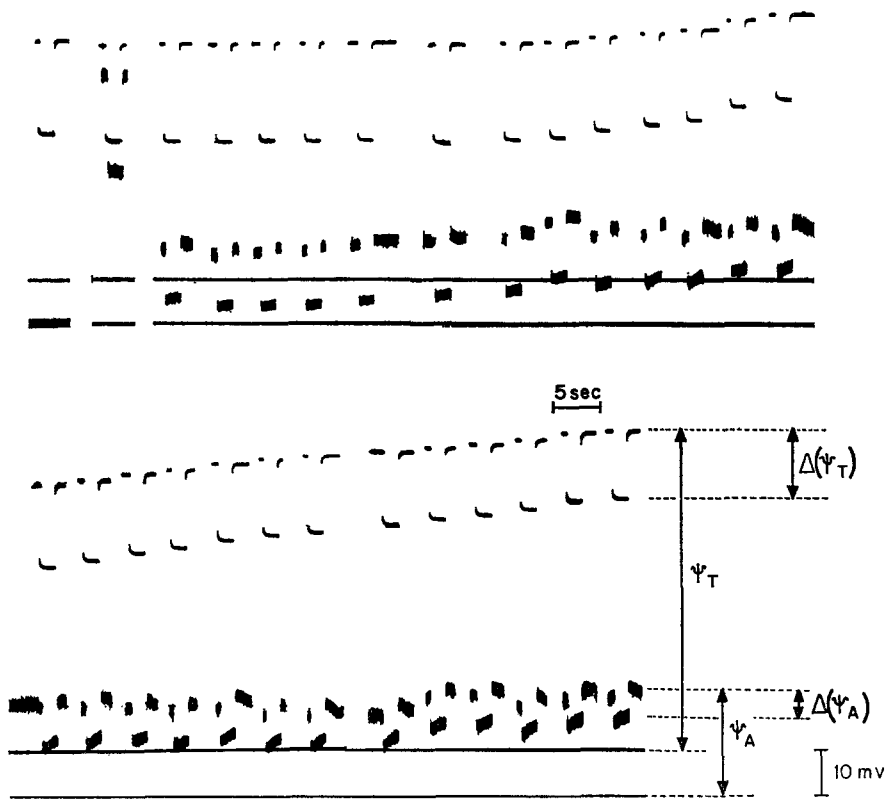

FIGURE 4. Electrical potential and resistance profile across the bladder before and during a vasopressin response (experiment 8). The figure consists of a consecutive series of current pulses measured during the course of one experiment. The spontaneous transbladder electrical potential is  $\psi_T$ ; the electrical potential between exploring micropipette, and reference mucosal solution is  $\psi_A$ . The deflections  $\Delta(\psi_T)$  and  $\Delta(\psi_A)$ , of the two traces occur in response to intermittent depolarizing pulses of  $28 \mu\text{amp}$  from the constant current generator, and are proportional to the resistances across the entire tissue and across the apical permeability barrier, respectively. The first recording in the upper left corner was obtained with the exploring micropipette in the mucosal solution;  $\psi_A$  and  $\Delta(\psi_A)$  are both zero. The second recording was obtained after advance of the micropipette across the mucosal epithelial layer;  $\psi_A \simeq \psi_T$  and  $\Delta(\psi_A) \simeq \Delta(\psi_T)$ . The micropipette was subsequently withdrawn slightly and the remaining traces were obtained at intervals of 0.4–2.1 min. An interval of 27 min elapsed between the third record in the upper left corner and the final record in the lower right corner. The time marks refer only to the duration of individual pulses. In this experiment, vasopressin was added in a final concentration of 100 mU/ml 2.3 min before the third record. The micropipette changed position just after the addition of hormone but was placed in another cell before any hormonal effect on  $\psi_T$  or  $\Delta(\psi_T)$  was evident. No hormonal effect was noted until the eleventh recording, after which  $\psi_T$ ,  $\Delta(\psi_T)$ , and  $\Delta(\psi_A)$  changed rapidly. Of the change in  $\Delta(\psi_T)$  following vasopressin, 104% could be attributed to the decrease in  $\Delta(\psi_A)$ . It will be noted that the  $\Delta(\psi_A)$  measured at the onset of the depolarizing current pulse was slightly less than the  $\Delta(\psi_A)$  measured at the end of the current pulse. This asymmetry was constant throughout the experiment, and the difference between the two values of  $\Delta(\psi_A)$  was less than 3% of the prehormonal  $\Delta(\psi_A)$ .

the micropipette tip was assumed to have occurred. In either case, the observations were rejected. With the use of these criteria, 10 successful impalements were obtained.

## 2. *The Form of the Voltage Deflection and the Resistive Properties of the Bladder*

The pulses from the constant current generator consisted of rectangular wave forms with a rise time of approximately 400  $\mu$ sec. At the time resolution employed in the experiments, this constituted a square wave. The form of the resulting voltage deflection across the tissue deviated from a square wave in one of two ways.

On application of the depolarizing current pulse,  $\psi_T$  decreased to a value close to the final state, which it then approached with a time constant occasionally as long as 1 sec. At the end of the pulse,  $\psi_T$  returned to the base line value with a similar time constant and without overshoot. This form of voltage deflection we will call type 1. It is illustrated in Fig. 4, a series of measurements made throughout the course of a single impalement during which vasopressin was administered.

Less commonly,  $\psi_T$  was observed to decrease abruptly at the onset of the current pulse but then to rise gradually despite continuation of the pulse at constant amplitude. At the end of the pulse,  $\psi_T$  rose abruptly, overshoot the base line value, and then returned to it with a time constant similar to that seen at onset. This pattern, which we will call type 2, is illustrated in the upper portion of Fig. 5. On occasion both types of deviations were seen at different times during the course of a single impalement, unrelated to the presence or absence of vasopressin.

The voltage between the micropipette and mucosal reference solution,  $\psi_A$ , or serosal reference solution,  $\psi_B$ , showed either a type 1 (Fig. 6) or a type 2 wave form (Fig. 4) in response to the current pulse. Because the response was not a square wave and its magnitude was an important datum, the details of its measurement are presented here.

As indicated earlier,  $\psi_T$  and  $\psi_A$  refer to the voltages observed across the bladder and across the apical permeability barrier, respectively. The *magnitudes of the deflections* in  $\psi_T$  and  $\psi_A$  which resulted from the passage of a pulse of current across the tissue are designated as  $\Delta(\psi_T)$  and  $\Delta(\psi_A)$ , respectively. In all records, the amplitude of  $\Delta(\psi_T)$  and  $\Delta(\psi_A)$  was measured as the peak response observed during the period of the current pulse. Thus, in dealing with type 1 wave forms,  $\Delta(\psi_T)$  and  $\Delta(\psi_A)$  were taken to be the difference between the voltage with zero current flow and the voltage when the full response was finally obtained. In dealing with type 2 wave forms  $\Delta(\psi_T)$  and  $\Delta(\psi_A)$  were measured as the difference in voltage at the break of the current pulse. During portions of each experiment in which type 2 wave forms were observed, the magnitude of  $\Delta(\psi_A)$  measured at the make was different from  $\Delta(\psi_A)$  meas-



ured at the break of the current pulse. Because of this, all calculations were carried out separately for the values at the onset and end of the current pulses;

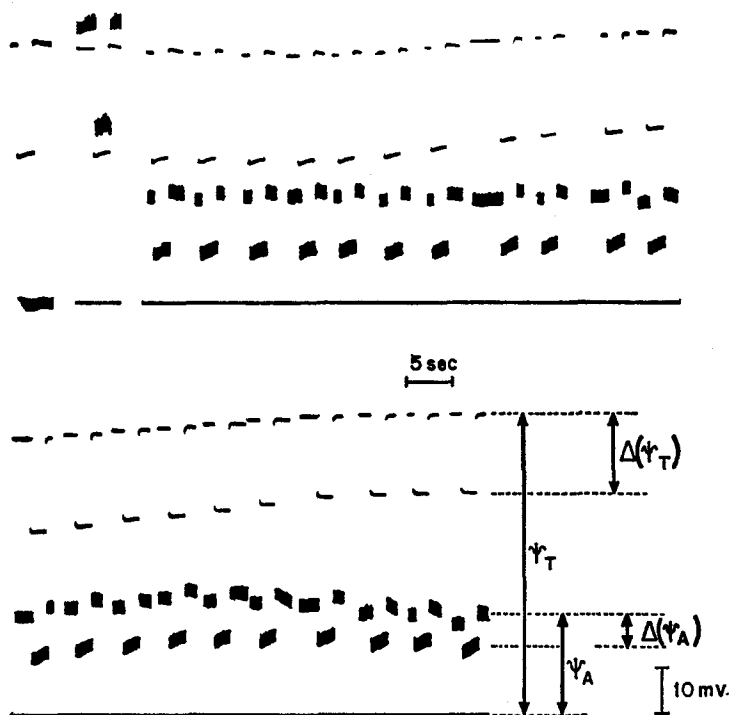

FIGURE 5. Electrical potential and resistance profile across the bladder before and during vasopressin response (experiment 10). See Fig. 4 for definitions of symbols. The figure consists of a consecutive series of current pulses measured during the course of one experiment. The time interval between the third recording in the upper left corner and the final recording in the lower right corner was 37 min. Records were obtained at intervals of 0.2–3.1 min; 70  $\mu$ amp pulses were used. The time marks refer only to the duration of individual pulses. Vasopressin was added to the serosal reservoir 4.9 min after the third recording; the final vasopressin concentration was 96 mU/ml. No hormonal effect is noted until the eighth recording. Of the total decrease in  $\Delta(\psi_T)$ , 72% is attributable to the decrease in  $\Delta(\psi_A)$ .

the results of the two analyses were found not to differ significantly. For simplicity, we have tabulated only the results of the calculations using the values of  $\Delta(\psi_A)$  at the end of the current pulse.

In 4 of the 10 experiments, the type of wave form observed in  $\psi_T$  was not the same as that seen in  $\psi_A$ , or the time constants of the responses differed appreciably. These differences do not seem to originate in the apparatus, since in Fig. 3, for example, no wave form is recorded from the micropipette when the tip is in the mucosal reference solution, and with the tip beyond the major

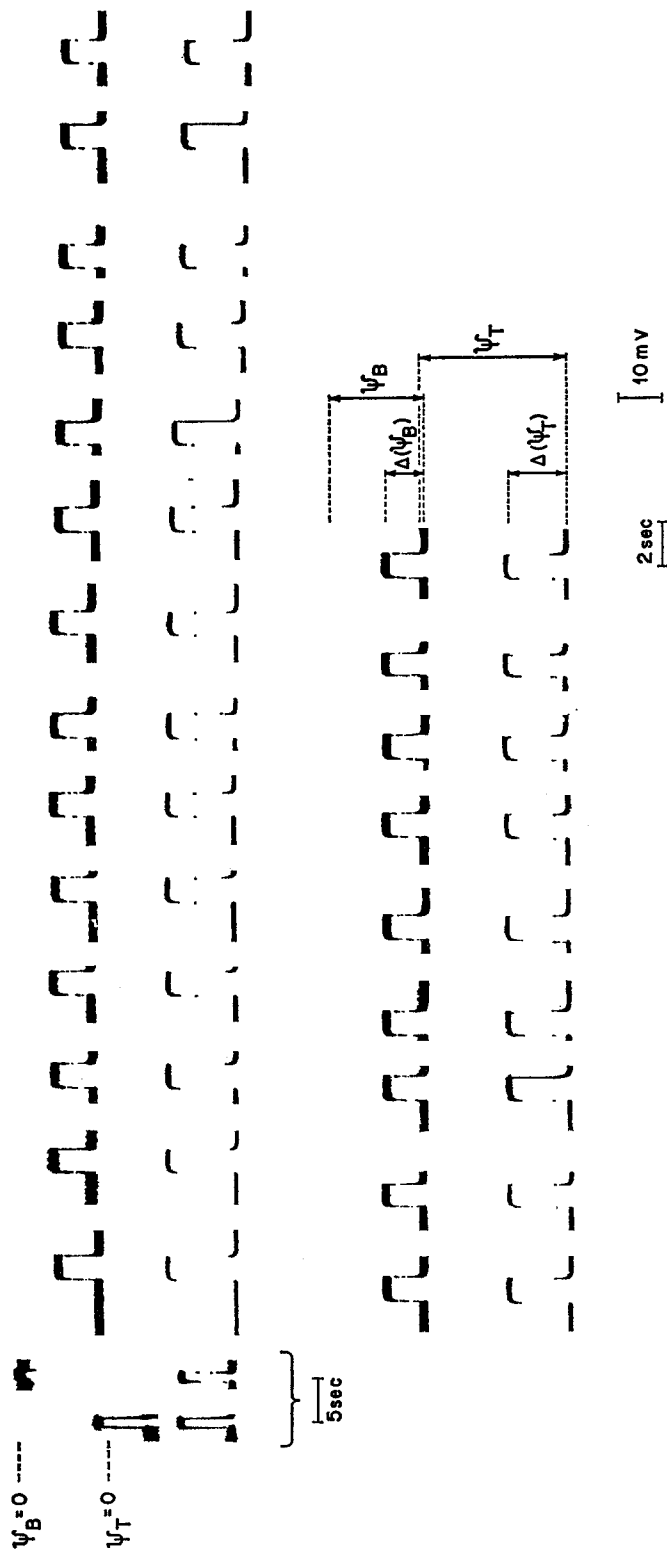

FIGURE 6. Electrical potential and resistance profile across the bladder before and during vasopressin response (experiment 2). The figure consists of one deflection from each of the consecutive trains of two or three current pulses applied to the bladder during the course of one experiment. The serosal medium has been grounded in this experiment so that the measured potentials are negative with respect to the zero potential reference lines in the upper portion of the traces. The potential difference between micropipette and ground is therefore the potential difference across the basal permeability barrier. The time interval between the third recording in the upper left corner and the final recording was 39 min. Records were obtained at intervals of 0.5–4.5 min. Vasopressin was added to the serosal

reservoir 0.5 min after the fifth trace in the upper left corner and again 1.0 min after the third record in the lower left corner; the resulting vasopressin concentrations were 31 and 62 mU/ml. No hormonal effect was noted until the eighth record of the upper row. None of the 15% decrease in resistance across the total tissue appears to be attributable to the basal permeability barrier. The deflection  $\Delta(\psi_B)$  is slightly, but significantly, greater than zero even after maximal tissue penetration, a finding observed whenever the advance of the micropipette was appreciably displaced from the position of the serosal reference bridge. No correction was made for this small effect.

permeability barriers, the form of the deflection is similar whether measured via the micropipette or the salt bridges on the two sides of the bladder. To further investigate the significance of the differences in the form of the deflections, hyperpolarizing and depolarizing pulses of varying magnitude were passed across the urinary bladder of the toad. Wave forms of types 1 and 2 were noted and plots of the current-voltage relationships were constructed, using the peak voltage responses on the one hand and the steady-state values on the other. The former gave a more linear relationship than the latter, a finding which is the justification for our use of the peak values in determining  $\Delta(\psi_T)$  and  $\Delta(\psi_A)$ .

3. *Changes in the dc Resistance of the Bladder and of the Apical Permeability Barrier after Treatment with Vasopressin*

Typical electrical responses of the bladder to vasopressin are shown in Figs. 4 and 5. Each record consists of measurements made during the period of impalement of a single epithelial cell. The distinguishing features of the effect are an increase in  $\psi_T$ , the spontaneous electrical potential across the bladder, little or no change in  $\psi_A$ , the spontaneous potential across the apical permeability barrier, and a decrease in the dc resistance of the bladder and of the apical barrier, the latter two quantities being proportional to  $\Delta(\psi_T)$  and  $\Delta(\psi_A)$ , respectively. For comparison, Fig. 6 shows an experiment in which the serosal solution was the reference point. The hormonal effect which is demonstrated consists of an increase in  $\psi_T$  and  $\psi_B$ , and a decrease in  $\Delta(\psi_T)$  with little or no change in  $\Delta(\psi_B)$ . The methods of quantifying the deflections due to the current pulses have been discussed in the preceding section; use of the results in determining the relative changes in resistance after vasopressin administration requires an additional comment.

The most straightforward method for evaluating relative changes in these variables would have been to compare the values of the ratio before the appearance of a vasopressin effect and after the maximal hormonal effect had been achieved, an interval as long as 15–20 min. Our difficulties in maintaining a constant position of the micropipette tip for such a period prevented this type of analysis in eight of the experiments. In order to incorporate the data from all experiments, it was necessary to use a method of analysis which could accommodate values of  $\Delta(\psi_A)$  and  $\Delta(\psi_T)$  which were changing during the period of observation. There are several alternative ways in which this could be done; we have elected simply to plot  $\Delta(\psi_A)$  as a function of  $\Delta(\psi_T)$ , and, because of the apparent linear relationship between the two variables (Fig. 7), to calculate the slope  $b$  of the line relating them by a least squares analysis.

The significance of  $b$  can be clarified by taking the derivative of equation (2) with respect to  $\Delta(\psi_T)$ , with the result shown in equation (4).

$$1 = d\Delta(\psi_A)/d\Delta(\psi_T) + d\Delta(\psi_B)/d\Delta(\psi_T) \quad (4)$$

The term  $d\Delta(\psi_A)/d\Delta(\psi_T)$  is equal to  $b$  obtained by the method outlined in the preceding paragraph. From equation (4) it is clear that if there is no change in  $\Delta(\psi_B)$ , the resistance of the basal permeability barrier, after vasopressin has

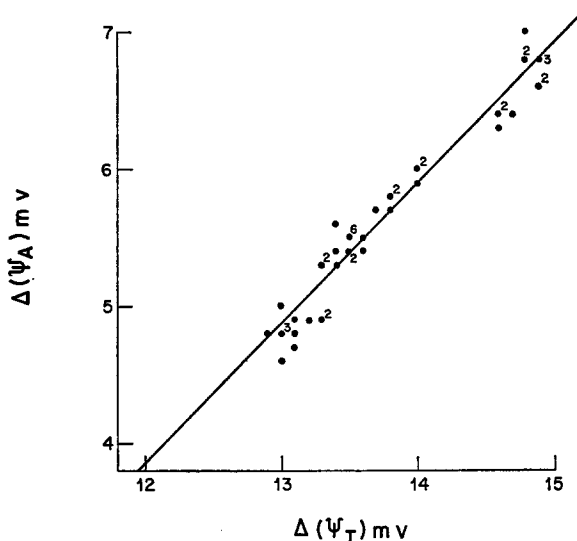

FIGURE 7.  $\Delta(\psi_A)$  as a function of  $\Delta(\psi_T)$  during the period when  $\Delta(\psi_T)$  was changing. The data are derived from the wave forms presented in Fig. 6. The regression line was obtained by a least squares analysis of the data as noted in the text; the equation of the line is:  $\Delta(\psi_A) = 1.02[\Delta(\psi_T)] - 8.4$ .  $\Delta(\psi_A)$  is seen to be a linear function of  $\Delta(\psi_T)$  over the period of observation.

brought about a decrease in  $\Delta(\psi_T)$ ,  $b$  will equal one. On the other hand, if the entire fall in the value of  $\Delta(\psi_T)$  is due to a decrease in  $\Delta(\psi_B)$ ,  $b$  will approach zero. If the observed decrease in the resistance of the bladder measured by the change in  $\Delta(\psi_T)$  is due to a proportionate decrease in both the apical and basal permeability barriers, then the value of  $b$ , which defines the contribution of the change in the apical barrier to the decrease in the total resistance of the bladder, will lie between the initial and final values for the relative resistance of the apical barrier, given by the ratio  $\Delta(\psi_A)/\Delta(\psi_T)$ . The slope  $b$  thus can vary between the limits one and zero, and expresses the relative portion of the change in resistance of the bladder which can be accounted for by the concomitant change in the resistance of the apical permeability barrier. Although each pair of values of  $\Delta(\psi_A)$  and  $\Delta(\psi_T)$  is obtained simultaneously, the final expression of  $b$  does not contain time as a variable. For this reason, it is possible

to use values obtained throughout the development of the vasopressin response prior to the achievement of a stable, peak effect.

Table I is a compilation of three types of information derived from the 10

TABLE I  
FRACTIONAL RESISTANCE OF APICAL PERMEABILITY  
BARRIER AND ITS ALTERATION BY VASOPRESSIN

Experiment	Relative apical contribution to total resistance change		Relative resistance of apical barrier		Probabilities			
	= $b^*$	$\Delta(\psi_A)/\Delta(\psi_T)$ Initial $\ddagger$	$\Delta(\psi_A)/\Delta(\psi_T)$ Final $\S$	$b = 1$	$b = 0$	$b = \Delta(\psi_A)/\Delta(\psi_T)$		$\Delta(\psi_A)/\Delta(\psi_T)$ Initial = final
						Initial	Final	
1	0.904±0.028 (32)	0.762±0.006 (10)	0.704±0.009 (8)	<0.01	<0.001	<0.001	<0.001	
2	1.019±0.034 (46)	0.435±0.007 (9)	0.369±0.004 (6)	>0.5	<0.001	<0.001	<0.001	
3	0.940±0.059 (13)	0.615±0.007 (4)	0.569±0.004 (3)	>0.3	<0.001	<0.001	<0.01	
4	1.084±0.105 (21)	0.542±0.006 (11)	0.498±0.005 (6)	>0.4	<0.001	<0.001	<0.001	
5	0.366±0.073 (16)	0.360±0.002 (3)	0.280±0.013 (3)	<0.001	<0.001	>0.9	<0.01	
6	0.741±0.027 (17)	0.438±0.008 (4)	0.205±0.005 (3)	<0.001	<0.001	<0.001	<0.001	
7	1.532±0.099 (31)	0.732±0.013 (12)	0.670±0.028 (3)	<0.001	<0.001	<0.001	>0.05	
8	1.043±0.074 (21)	0.595±0.009 (6)	0.408±0.007 (3)	>0.5	<0.001	<0.001	<0.001	
9	1.414±0.218 (5)	0.367±0.03 (SD)		>0.1	<0.01	<0.01	<0.01	
10	0.754±0.044 (22)	0.529±0.007 (13)	0.422±0.013 (4)	<0.001	<0.001	<0.001	<0.001	
Grand average	0.980±0.105	0.538±0.045	0.458±0.056					

\* These values are the slopes of the plots of  $\Delta(\psi_A)$  against  $\Delta(\psi_T)$  for each experiment, determined as described in the text. The measure of variation is the standard error of the mean except as specifically noted. The numbers in parentheses indicate the number of observations.

$\ddagger$  The observations in this column were made before the onset of the first detectable change in transbladder resistance after administration of vasopressin.

$\S$  The values in this column were obtained during the peak observed effect of the hormone. In seven, the transbladder resistance was still declining at the time the measurements had to be terminated; in the remaining two, the transbladder resistance reached a new stable value during the period of observation.

successful impalements. The initial values of the ratio  $\Delta(\psi_A)/\Delta(\psi_T)$  indicate the relative resistance of the apical permeability barrier before the addition of vasopressin (column 2). The values of the same ratio are also recorded for the measurements made during the period after hormonal treatment and just before the termination of the experiment (column 3). In only two of the experiments could the position of the micropipette tip be maintained until the maximal hormonal effect was achieved. In addition, the slope  $b$  is shown, representing the relative portion of the total change in resistance of the bladder which could be accounted for by the change in resistance of the apical permeability barrier (column 1). The values of  $\Delta(\psi_A)$  and  $\Delta(\psi_T)$  used to

calculate  $b$  were those obtained after the first detectable change in resistance following administration of vasopressin.

By means of Student's  $t$ -test, the significance of the calculated value of  $b$  in each experiment can be determined by a comparison with 1.0, the theoretical value for an entirely apical effect of the hormone, with zero, the theoretical value for an entirely basal effect, and with the observed value of  $\Delta(\psi_A)/\Delta(\psi_T)$ , which  $b$  would approach if the total resistance change were divided proportionately between apical and basal permeability barriers. The results of such comparisons are shown in the right-hand portion of the table.

The last column in the table shows a comparison for each impalement of the significance of the observed difference in the relative resistance of the apical barrier before and after administration of vasopressin.

In 9 of the 10 experiments, the fall in resistance of the apical permeability barrier was significantly greater than could be accounted for by a proportionate effect on both apical and basal sites (column 6). In five of the experiments, the effect was indistinguishable from a change restricted to the apical site (column 4). In experiment 5, the value of  $b$  did not differ from that of the relative resistance of the apical barrier noted initially. More than one interpretation can be advanced for this observation, but the simplest is that the cell was not responsive to vasopressin, either because of damage associated with the impalement or because the cell was of a different type. The value of  $b$  from experiment 7 was significantly greater than one. A likely explanation for this observation is the presence of a shunt pathway, perhaps in the apical permeability barrier around the site of penetration of the micropipette.

The combined data from all the experiments show that 54% of the initial DC resistance across the bladder was associated with the apical permeability barrier. The decrease in total resistance of the bladder after vasopressin could be accounted for to the extent of 98% by a fall in the resistance of the apical barrier. This value is significantly different from the value of 54% which would have resulted from a proportionate decrease in the resistance of both apical and basal permeability barriers, and is not significantly different from the 100% value which would be expected from an exclusively apical site of action of vasopressin.

#### DISCUSSION

Vasopressin increases both the net flux of  $\text{Na}^+$  across the bladder and the size of the tissue pool of isotopic  $\text{Na}^+$  originating from the mucosal medium; these observations were the basis for the original suggestion of an apical site of hormonal action on transport (5, 9). This analysis assumes that the bladder can be viewed as two permeability barriers in series, representing the mucosal and serosal surfaces of an homogeneous population of cells. Electron microscopic examination demonstrates at least three, and possibly four, types of

cells in the epithelial layer (1, 14). In addition, the spatial relationships among the epithelial cells probably are not as simple as was supposed originally. Thus the assumption of cellular homogeneity is at odds with the facts, and the more crucial one of structural simplicity is still under study.

The simultaneous efflux of isotopic  $\text{Na}^+$  from both surfaces of the bladder was measured in an effort to obtain more direct evidence for the site of action of vasopressin (6). Although the results supported the conclusions from the flux and pool experiments, the present state of development of the flow chamber method is not sufficient for the findings to be considered conclusive.

Application of the polyene antibiotic, Amphotericin B, to the mucosal surface of the bladder causes a sustained increase in net transport of  $\text{Na}^+$  and a fall in DC resistance, mimicking in these respects the action of vasopressin (11). Since Amphotericin is unlikely to stimulate the active transport mechanism directly, it appears unnecessary to invoke an effect of vasopressin on the  $\text{Na}^+$  pump itself.

More direct evidence on this latter point comes from the observation that vasopressin may reduce the resistance to  $\text{Na}^+$  movement through the bladder without increasing the driving force of the active transport mechanism (2).

Thus, although there is compelling evidence that vasopressin does not act on the  $\text{Na}^+$  pump, there is a dearth of direct evidence that its site of action is at the apical or mucosal face of the bladder. The present study was designed to provide a direct test of the site of hormonal action by making use of the electrical consequences of its administration.

The experimental findings show that the entire fall in the DC resistance of the bladder after vasopressin administration can be accounted for by the change in the permeability barrier behind the micropipette tip, or toward the mucosal surface of the bladder. The issue is how to interpret this finding in the light of the morphology of the tissue. At the site within the bladder where the measurements were made, an average of 46% of the total transbladder resistance lay ahead of the micropipette tip, toward the serosal surface of the tissue. The serosal limiting membrane, a reflection of the mesothelium lining the body cavity of the toad, contributes only approximately 5% of the DC resistance of equivalent areas of bladder (4). In addition, in cell types where the measurements have been made, the electrical resistance of the plasma membrane is large compared to that of the cytoplasm. These two findings indicate that at least one plasma membrane of a cell in the epithelial layer lay both in front of and behind the micropipette tip at the time of observation. On the basis of present knowledge, there may be scattered, electrically isolated collections of extracellular fluid between the epithelial cells which face on the mucosal surface and the basal cells which lie next to portions of the basement membrane (13, 14), and penetration of such a closed space with the micropipette could yield the results observed. The existence of structures with these require-

ments is not yet established, however, and in any event, it is highly unlikely that all the impalements would have resulted in penetration of such a cavity. For these reasons, we conclude that the micropipette tip was in the cytoplasm of an epithelial cell facing on the mucosal medium, with the apical plasma membrane behind the tip and the basal membrane ahead of it. Since all the decrease in transbladder resistance after vasopressin could be accounted for by a change in the apical permeability barrier, it seems clear that the hormonal effect occurs at this site.

Without the use of a marking technique, it is not possible to specify which of the three or four cell types in the epithelial layer was actually penetrated. The most frequent cell type, the granular cell (1), is likely to be represented in the 10-impalements. The similarity of response in 90% of the impalements suggests that either more than one cell type is responsive to the hormone or that nine of the determinations were made in granular cells.

The decrease in electrical resistance at the apical surface of the cell results from an increase in the mobility of at least one ion at this site. Measurement of the partial ionic conductances across this barrier will be required to determine the selectivity of the hormonal effect, but from the constancy of the transbladder permeability to other small ions (10) the change is probably specific, or very nearly so, for  $\text{Na}^+$ . If this expectation is correct, then the observation of a fall in the resistance of the apical permeability barrier suggests that the vasopressin-sensitive pathway for transport of  $\text{Na}^+$  communicates with the cytoplasm of the epithelial cells. Other interpretations are possible, however, and the issue cannot be settled on the basis of available evidence.

The form of the voltage deflections across the entire bladder in these experiments was characterized by a time constant as long as 1 sec, and occasionally, by overshoot. In addition, an asymmetry could sometimes be detected in the make and break of the pulse as recorded across the apical permeability barrier. The duration as well as the form of these transients, precludes an explanation based on a simple RC network. At least three additional mechanisms should receive consideration: (a) the depolarizing pulse could affect the active transport mechanism directly, (b) the change in the potential profile at each mobility barrier might affect the barrier so that ionic mobilities would be altered, (c) the passage of current could alter the concentration of current-carrying ions within the cell or in the permeability barriers themselves. These possibilities are now under study.

It is a pleasure for the authors to acknowledge their gratitude to Dr. Alexander Leaf for his interest, encouragement, and support. We would like also to thank Dr. Donald DiBona for providing us with an electron micrograph of one of the micropipettes.

Dr. Frazier is the recipient of Career Development Award 1-K3-HE-31, 106 from the United States Public Health Service.

This work was supported in part by funds from the John A. Hartford Foundation, Inc., and the United States Public Health Service (Grant No. HE-06664). A preliminary report was presented



before the American Society for Clinical Investigation, Atlantic City, N.J., on 30 April 1967, and appeared in abstract form in *J. Clin. Invest.* 1967. **46**:1045.

*Received for publication 1 August 1967.*

#### REFERENCES

1. CHOI, J. K. 1963. The fine structure of the urinary bladder of the toad, *Bufo marinus*. *J. Cell. Biol.* **16**:53.
2. CIVAN, M. M., O. KEDEM, and A. LEAF. 1966. Effect of vasopressin on toad bladder under conditions of zero net sodium transport. *Am. J. Physiol.* **211**:569.
3. FINKELSTEIN, A. 1964. Electrical excitability of isolated frog skin and toad bladder. *J. Gen. Physiol.* **47**:545.
4. FRAZIER, H. S. 1962. The electrical potential profile of the isolated toad bladder. *J. Gen. Physiol.* **45**:515.
5. FRAZIER, H. S., E. F. DEMPSEY, and A. LEAF. 1962. Movement of sodium across the mucosal surface of the isolated toad bladder and its modification by vasopressin. *J. Gen. Physiol.* **45**:529.
6. FRAZIER, H. S., and E. I. HAMMER. 1963. Efflux of sodium from isolated toad bladder. *Am. J. Physiol.* **205**:718.
7. GATZY, J. T., and T. W. CLARKSON. 1965. The effect of mucosal and serosal solution cations on bioelectric properties of the isolated toad bladder. *J. Gen. Physiol.* **48**:647.
8. LEAF, A., J. ANDERSON, and L. PAGE. 1958. Active sodium transport by the isolated toad bladder. *J. Gen. Physiol.* **41**:657.
9. LEAF, A., and E. F. DEMPSEY. 1960. Some effects of mammalian neurohypophyseal hormones on metabolism and the active transport of sodium by the isolated toad bladder. *J. Biol. Chem.* **235**:2160.
10. LEAF, A., and R. M. HAYS. 1962. Permeability of the isolated toad bladder to solutes and its modification by vasopressin. *J. Gen. Physiol.* **45**:921.
11. LICHTENSTEIN, N. S., and A. LEAF. 1965. Effect of Amphotericin B on the permeability of the toad bladder. *J. Clin. Invest.* **44**:1328.
12. LING, G., and R. W. GERARD. 1949. The normal membrane potential of frog sartorius fibers. *J. Cellular Comp. Physiol.* **34**:383.
13. PAK POY, R. F. K., and P. J. BENTLEY. 1960. Fine structure of the epithelial cells of the toad urinary bladder. *Exptl. Cell Res.* **20**:235.
14. PEACHEY, L. D., and H. RASMUSSEN. 1961. Structure of the toad's urinary bladder as related to its physiology. *J. Biophys. Biochem. Cytol.* **10**:529.