

Hacking CD/DVD/Blu-ray for Biosensing

Edwin En-Te Hwu* and Anja Boisen

Center for Intelligent Drug Delivery and Sensing Using Microcontainers and Nanomechanics (IDUN), Department of Micro- and Nanotechnology, Technical University of Denmark, Lyngby 2800, Denmark

Supporting Information

ABSTRACT: The optical pickup unit (OPU) within a CD/DVD/Blu-ray drive integrates 780, 650, and 405 nm wavelength lasers, diffraction-limited optics, a high-bandwidth optoelectronic transducer up to 400 MHz, and a nano-resolution x -, z -axis, and tilt actuator in a compact size. In addition, the OPU is a remarkable piece of engineering and could enable different scientific applications such as sub-angstrom displacement sensing, micro- and nanoimaging, and nanolithography. Although off-the-shelf OPU's can be easily obtained, manufacturers protect their datasheets under non-disclosure agreements to impede their availability to the public. Thus, OPU's are black boxes that few people can use for research, and only experienced researchers can access all their functions. This review details the OPU mechanism and components. In addition, we explain how to utilize three commercially available triple-wavelength OPU's from scratch and optimize sensing quality. Then, we discuss scientific research using OPU's, from standard optical drive-based turnkey-biomarker array reading and OPU direct bioapplications (cytometry, optical tweezing, bioimaging) to modified OPU-based biosensing (DNA chip fluorescence scanning, biomolecular diagnostics). We conclude by presenting future trends on optical storage devices and potential applications. Hacking low-cost and high-performance OPU's may spread micro- and nanoscale biosensing research from research laboratories to citizen scientists around the globe.

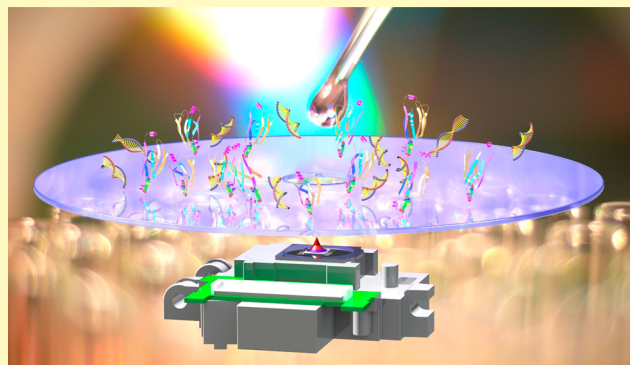

KEYWORDS: compact disc (CD), digital versatile disc (DVD), Blu-ray, optical pickup-unit (OPU), nanobio imaging, cytometer, optical tweezer, DNA chip, fluorescence, medical diagnostics

Some years ago, the global market of digitized music, video, and data storage pushed the capacity and speed of optical drives to their limits, with a huge amount of R&D investment. From compact discs (CDs), digital versatile discs (DVDs), to the most recent Blu-ray discs, the data capacity evolved from the megabyte (MB) to the gigabyte (GB). Likewise, mass production and outstanding sales dramatically reduced the cost of optical storage drives while maintaining high quality and performance. Nowadays, Blu-ray players (12× speed, 432 Mb/s) are affordable devices that reliably read 150 nm data pits from a spinning disc at 10,000 rpm.

Optical drive components have been used for research over the past decades, as they adopt an accessible standard of CD/DVD/Blu-ray disc, and the spindle motor can be used for centrifugal lab-on-disc applications.^{1,2} Most of this research relies on either commercially available optoelectrical sensing systems or customized sensing mechanisms.^{3–8} A seldom considered component inside optical drives is the optical pickup unit (OPU), which is essential for converting physical data pits into electric signals. A CD/DVD/Blu-ray drive OPU equips at least one triple-wavelength laser and optimized optical components to achieve the diffraction limit of light for high-density data-pit reading. To focus the laser spot perfectly on a spinning and wobbling disc, an objective lens is actuated

by a high-bandwidth triple-axis precision actuator. The light intensity signal reflected from the data pits is then transduced by a specialized high-bandwidth optoelectrical component. These functions are compactly integrated within an eraser-sized box, representing a low-cost and high-performance engineering achievement.

Although off-the-shelf OPU's can be unrestrictedly purchased, accessing their full functions can be much more challenging. In fact, every manufacturer protects the OPU datasheets and hardware pin assignment under secrecy, and hence any researcher needs to either sign a nondisclosure agreement or reverse engineer the OPU to access its functions. This technical barrier has prevented researchers, especially those without an engineering background, from utilizing OPU's with research purposes, and only few groups have managed to access all the OPU functions for its use in applications such as sub-angstrom displacement sensing,⁹ micro- and nanoimaging,¹⁰ and nanolithography.¹¹ Interestingly, an OPU-based low-cost atomic force microscope (AFM) has already

Received: April 29, 2018

Accepted: July 6, 2018

Published: July 6, 2018

democratized nanoimaging up to the point that even children can perform nanoscale measurements by themselves.^{12,13}

Before exploiting the full potential of the OPU in a CD/DVD/Blu-ray drive, we must understand its mechanism and main components. We distinguish the types of OPUs that are flexible for scientific research and explain how to increase the signal-to-noise ratio and couple external optical sensors to enhance sensing quality. Then, we further describe how to control the OPU in practice, by using either specific software tools or customized circuits. We dedicate another part of the review to surveying biosensing studies using OPUs, including standard optical drive-based turnkey biosensing, OPU direct bioimaging, and modified OPU-based systems for advanced bioapplications.

■ OPENING THE BLACK BOX: THE OPU MECHANISM

From CDs and DVDs to Blu-ray discs, higher data capacity requires smaller data pits on the same 12-cm-diameter disc, as illustrated in Figure 1.¹⁴ Likewise, higher data density demands

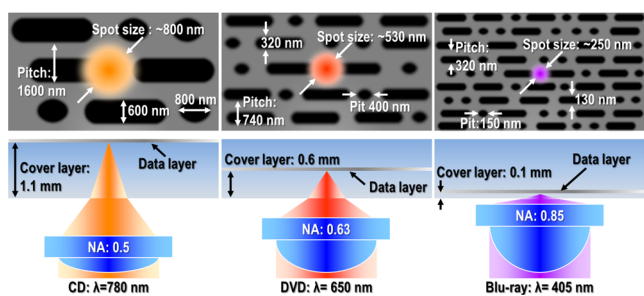

Figure 1. CD/DVD/Blu-ray disc data pit, pitch, and laser spot dimensions.¹⁴

shorter laser wavelength λ (CD: 780 nm, DVD: 650 nm, Blu-ray disc: 405 nm) and higher numerical apertures (NAs) of objective lenses (CD: ~ 0.5 , DVD: ~ 0.63 , Blu-ray disc: 0.85) to focus the laser on nanoscale data pits (CD: 800 nm, DVD: 400 nm, Blu-ray disc: 150 nm). The OPU focuses a polarized laser to the diffraction limit of light, with full width at half-maximum being approximately 800 nm for CD, 530 nm for DVD, and 250 nm for Blu-ray disc.¹⁵ In addition, each data pit has a depth of $\lambda/4$, and when the laser hits the pit, the reflection is destructively interfered and the OPU receives a low reflection corresponding to the digital signal “0”, whereas if no pit is hit, the higher intensity reflection is translated as the digital signal “1”.

A transparent hard-coat polycarbonate cover layer¹⁶ (CD: 1.1 mm, DVD: 0.6 mm, Blu-ray: 0.1 mm in thickness) protects the data pits from being destroyed by scratching and has a refractive index of 1.6. This layer is an essential optical component of the storage system, as its absence could cause spherical aberration, creating an optical path difference which could exceed 0.2 of the light wavelength. Consequently, the optical path difference could reduce in more than 20% the reflected laser intensity.¹⁷

Figure 2 illustrates the structure of a typical CD/DVD/Blu-ray OPU.¹⁸ A triple-wavelength semiconductor laser diode, its most expensive component, emits a laser beam that is collimated, linearly polarized, and focused on a disc by a collimator, a polarized beam splitter, and an objective lens, respectively. The reflected laser from the disc passes through

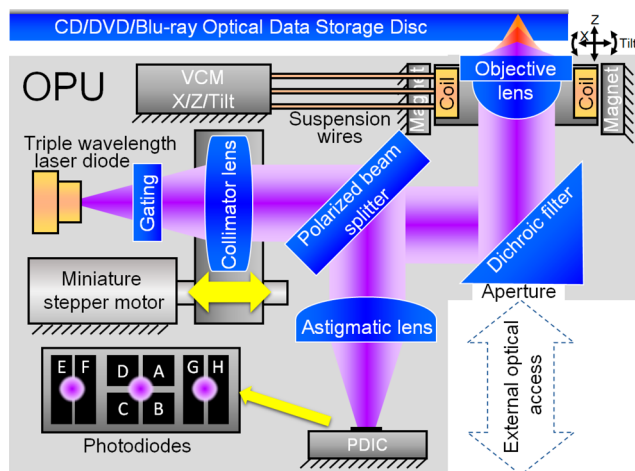

Figure 2. Diagram of the optical path in a typical triple-wavelength OPU.¹⁸

the same optical path back to an astigmatic lens and impinges onto a photodiode integrated circuit (PDIC).

To achieve better signal integrity and lower relative intensity noise, the laser diode is modulated within a frequency from 300 to 500 MHz to mitigate laser coherence.¹⁹ Next to the laser diode, a diffraction grating splits the laser into three beams to generate data tracking feedback control signals.^{20,21}

Then, the collimator lens, which is linearly driven by a miniature stepper motor along the laser beam direction, adjusts its position to accurately vary the OPU focal distance. This fine-tuning compensates the effect from both the different disc cover layer thicknesses and the switching target data layers (for single-sided dual-layer DVDs and Blu-ray discs) while reading the disc. The objective lens integrates aspherical and diffractive optical design to focus 780, 650, and 405 nm laser beams to the diffraction limit of light.²² A dichroic filter reflects the laser light to the objective lens, which has reflective coatings for the OPU operation wavelengths. Some OPUs have a clear aperture in the back of the dichroic filter to allow external optical access, despite being preferable to avoid the OPU operation wavelengths. This aperture enables the external coupling of optical components for applications such as optical imaging²³ and fluorescence light sensing.²⁴

While reading data pits on a fast-spinning disc, an x -, z -axis and tilt electromagnetic actuator, known as voice coil motor (VCM), allows focusing the laser on the data layer. Three pairs of suspension wires mechanically suspend an objective lens holder and electrically conduct driving signals to the x -, z -axis, and tilt coils inside the holder. The VCM has an operation bandwidth of 20 kHz for moving the objective lens along the z -axis ($\pm 1000 \mu\text{m}$) for data layer focusing and the x -axis ($\pm 350 \mu\text{m}$) for following spiral data tracks, whereas tilting ($\pm 1^\circ$) compensates the data layer angular variation due to disc wobbling. The x - and z -axes usually have a sensitivity of $1 \mu\text{m}/\text{mV}$ to achieve nanoscale resolution with precise driving signals that can be used in various applications.^{25–27}

The PDIC consists of current preamplifiers for photodiodes A to H in Figure 2 (CXA2875GA, Sony Co., Tokyo, Japan), which have an operation bandwidth up to 400 MHz. Given the laser splitting grating, there are three laser spots reflected onto the PDIC, and photodiodes A to H monitor the laser spots and provide signals S_A to S_H , respectively.

Figure 3 shows the center laser spot shape according to the laser focusing, which is described as an astigmatic method.²⁸

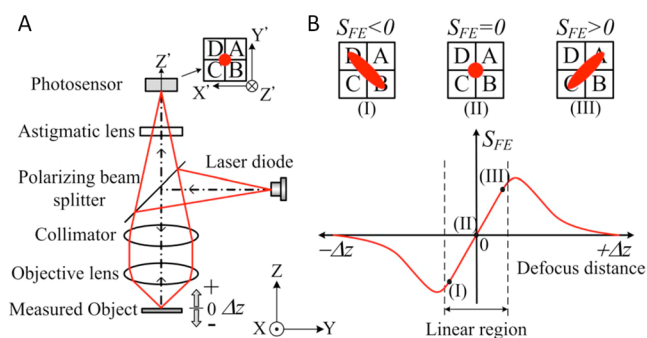

Figure 3. Focusing detected by astigmatic method. (A) Astigmatic optics inside OPU. (B) Focus error signal S_{FE} according to defocus distance. Reprinted with permission from ref 28. Copyright 2007 AIP Publishing.

When the laser is focused on an object ($z = 0$), the laser spot on the PDIC projects a circular shape. When the focal point is off-center, the laser spot projects an elliptical shape with the major axis along photodiodes A–C ($S_{FE} > 0$) or B–D ($S_{FE} < 0$). This changing shape can be expressed as focus error signal $S_{FE} = (S_A + S_C) - (S_B + S_D)$, which is used to control the VCM for focusing the laser precisely on a target and has been proven to exhibit subatomic resolution for AFM applications.^{28,29}

OPUs can feature different functions (reading and writing) and sizes (half height, slim type). From our experience, CD/DVD/Blu-ray OPUs can provide flexibility for scientific research given the characteristics shown in Table 1, which summarizes the core components from ten different types of OPUs.

Table 1. Characteristics of Main Components from Different CD/DVD/Blu-ray OPUs

component	characteristic	type	value	unit
Objective lens	Lens NA	CD	0.47–0.53	-
		DVD	0.6–0.66	
		Blu-ray	0.85	
	Laser spot size (full width at half-maximum)	CD	~800	nm
		DVD	~530	
		Blu-ray	~250	
	S-curve linear region	CD	~15	μm
DVD		~6		
Blu-ray		~0.3		
Working distance (lens to disc)	CD	0.55–0.86	mm	
	DVD	0.63–1.25		
	Blu-ray	0.27–0.61		
Semiconductor laser diode	Wavelength	CD	770–790	nm
		DVD	645–660	
		Blu-ray	400–410	
	Power (Average)	CD	160–1130	mW
DVD			170–830	
	Blu-ray		340–450	
	VCM	Working distance	x-axis	± 350
z-axis			± 1000	μm
Tilt			± 1	$^\circ$
PDIC	Operation bandwidth	CD	25–90	MHz
		DVD	50–130	
		Blu-ray	110–400	

DRIVING OPUS FROM SCRATCH

The easiest way to gain access to the OPU for biosensing is by using an optical disc diagnostic software, which can be downloaded online for free. There are at least four diagnostic software tools: PlexUtilities v 1.3.3 (Plextor, USA), K-Probe2, QpxTool by Gennady Kozlov, and Opti Drive Control by Erik Deppe. PlexUtilities offers more diagnostic tools, whereas Opti Drive Control has enhanced hardware compatibility.³⁰ Furthermore, a Linux-based software allows one to burn and analyze data sectors on the disc.³¹ This type of software can read logical error correction codes (ECCs) on the disc including detect parity inner errors and parity inner failures, where the former indicate correctable reading/data errors of a logical ECC block on the disc, and the latter determines whether an ECC block contains uncorrectable errors. The Blu-ray utilizes more powerful ECCs which contains long distance code and burst-indicating subcode to protect the data on the disc.³² The ECCs can indicate scratches or polluted parts on the disc surface. We can exploit these features to drive almost every kind of OPU inside optical drives and perform certain biosensing applications as described later.

Inside the CD/DVD optical drives, it is relatively easy to gain access to the OPU. A very efficient method to determine the input/output pin assignment and operating parameters of the OPU laser, PDIC, and VCM is by measuring the voltage and current of each component during operation. Then, the retrieved parameters can be used to drive the OPU for different applications. Unfortunately, it is much more difficult to reverse engineer triple-wavelength OPUs and determine their pin assignment using this method, because most of them have built-in microcontrollers that receive and deliver digital commands for operation.

Supporting Information of this review provides three controller circuit designs with their parameters for the widely available OPUs PHR-803T (Toshiba Co., Tokyo, Japan) inside the XBOX 360 (Microsoft Co., Redmond, WA, USA), KEM 410 with dual objective lens (Play Station 3; Sony Co., Tokyo, Japan), and SF-BC620L (Sanyo Electric Co., Ltd., Osaka, Japan). The customized controllers grant access to all the functions of these OPUs, including CD/DVD/Blu-ray laser switching and power adjustment, modulation frequency control, VCM x -, z -axis and tilt actuation, PDIC filter, gain and modes switching, and miniature stepper motor control.

RECOMMENDATIONS FOR OPU-BASED APPLICATIONS

It is recommended to keep the cover layer, whose thickness depends on the operation wavelength, in front of the OPU objective lens to guarantee optimal laser focusing. Microscopy cover glasses provide a similar refractive index (1.47 to 1.5) as the cover layer or one can simply use the disc hard-coat polycarbonate cover layer. Furthermore, the cover layer can be used for sealing microfluidic channels. OPU-based imaging or sensing through different media, such as liquid or gas, demands the optimization of the distance between the cover layer and measurement target.³³ Moreover, removing the laser splitting grating can increase the laser intensity up to 25% for improved signal-to-noise ratio in sensing applications.

Compared with CD/DVD laser, the Blu-ray 405 nm laser has a focal point of approximately 250 nm, thus being suitable for high-resolution fluorescence imaging. However, the Blu-ray laser may destroy live-cell samples while imaging depending on

the dose. Likewise, the Blu-ray phototoxicity might cause plasma membrane permeabilization, cytoskeleton destruction,³⁴ and DNA damage.³⁵ These aspects should be thoroughly considered when using Blu-ray technology for biosensing and imaging.

■ OPU-BASED BIOSENSING

Turnkey Biosensing. The above-mentioned software tools can turn standard CD/DVD/Blu-ray optical drives into turnkey biosensing instruments.³⁰ Besides custom-made bio-CD for multiplexing DNA microarray detection,³⁶ biomolecular complex assay spots can be inject-printed onto the cover layer of a standard CD.³¹ Then, a diagnostic analysis of ECCs can be performed while the OPU reads data through the bioassays to quantitatively extract colorimetric characteristics of different assay spots on the cover layer. Figure 4 illustrates the typical ECC-based method for biotin–streptavidin binding, DNA hybridization, and protein–protein interaction sensing.³⁷ In addition, this method can be employed to detect DNase assay at the part-per-billion level.³⁸

The ECC-based method has been extended for applications such as onsite pregnancy test,³⁹ multiplexed drug abuse diagnostics,⁴⁰ heavy metal detection,⁴¹ and acute myocardial infarction monitoring.⁴¹ Furthermore, Blu-ray optical drives have been shown to increase the resolution and sensitivity for biosensing,^{42,43} reaching a sensitivity and selectivity comparable to standard enzyme-linked immunosorbent assays.

A professional CD/DVD/Blu-ray disc testing or quality control platform, which is normally used during optical disc production, can be repurposed to monitor on-disc biotin–streptavidin binding at a linear speed of 4.0 m/s. Unlike ECC-based biosensing, such platforms provide an analog reflection intensity signal from the disc.⁴⁴ Following that approach, a commercially available optical drive can connect the OPU PDIC analog output to a data acquisition device, thus enabling more flexibility for biosensing applications, such as reading on-disc biochemical films to determine Ca^{2+} concentrations with a detection limit of ± 5 ppm,^{45,46} measuring on-disc multiplexed microimmunoassays (e.g., pesticides, antibiotics),⁴⁷ detecting Haemagglutinin of influenza virus,⁴⁸ and sensing RNA aptamers generated against reverse transcriptase interaction.⁴⁹ Furthermore, the OPU can be extracted from the drive for C-reactive protein measurement with a detection limit of 1 pM.⁵⁰

Cytometer and Optical Trap. Blood cell count and sizing can provide insightful information during AIDS, sepsis, anemia, and leukemia diagnoses. A conventional CD modified with a polydimethylsiloxane microfluidic channel can be read by a standard optical drive for counting microparticles and living cells and determining concentrations based on ECCs.⁵¹ Figure 5 illustrates a conventional and an OPU-based cytometer, which integrates a lab-on-chip device. The OPU-based cytometer has been used to count individual polystyrene beads between yeast cells,⁵² erythrocytes,⁵³ Chinese hamster ovary,⁵⁴ and cattle erythrocytes⁵⁵ by analyzing focus error signal S_{FE} as depicted in Figure 6.

A DVD burner OPU equips a laser with approximate power of 200 mW and can generate tens of piconewtons of force at the focal point. This force is enough to trap colloid or red blood cells.⁵⁶ Furthermore, the VCM can precisely steer the cells to different channels. This setup has been used to isolate microparticles and red blood cells nondestructively by controlling the OPU with an Arduino board (Arduino LLC,

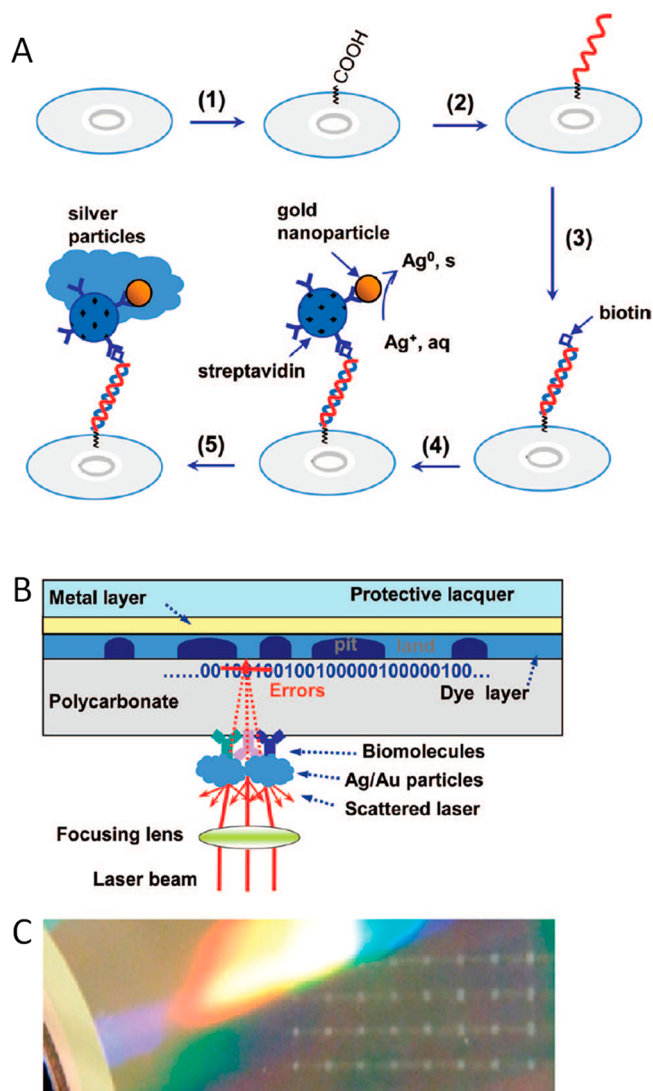

Figure 4. (A) Preparation of disc-based bioassay and signal amplification using gold/silver staining. (1) UV/ozone activation to generate carboxylic acid groups on CD surface; (2) immobilization of amino-tethered DNA probe strands via amide coupling; (3) hybridization with biotinylated DNA target strands; (4) binding of gold nanoparticle–streptavidin conjugates; (5) reductive precipitation of silver particles for signal enhancement. (B) Digital reading of bioassay using CD drive. The biomolecule/nanoparticle conjugates block the reading laser and generate errors. (C) Optical image of DNA microarray formed on a regular CD-R according to the above surface reaction and signal amplification. Reprinted with permission from ref 37. Copyright 2008 American Chemical Society.

USA) in a gravity-driven microfluid device,⁵⁷ as shown in Figure 7.

Direct Bioimaging. The OPU laser focus to the diffraction limit of light has been used as principle for a high-resolution laser scanning microscope to monitor morphological changes in astrocytes and investigate apoptosis triggered by *Toxocara canis* larval excretory-secretory antigens.⁵⁸ The OPU-based direct bioimaging system setup is similar to that shown in Figure 5B, except for the microchannel. The OPU laser focuses on astrocytes incubated on a reflective substrate. Then, the substrate is raster scanned by a piezoelectric scanner while the OPU reads out the focus error signal. The astrocytes can be represented by mapping the focus error array into a grayscale

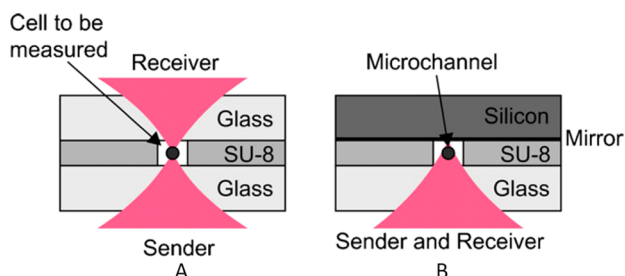

Figure 5. (A) Conventional optical flow cytometer. (B) Mirror measurement setup using DVD OPU. The laser beam is reflected to the OPU. Reprinted with permission from ref 54. Copyright 2008 Elsevier.

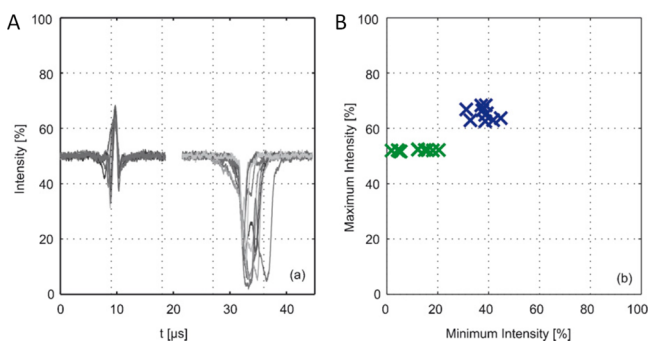

Figure 6. Erythrocytes and beads cause focus error signal S_{FE} to rise and drop, respectively. Consequently, the number of cells or beads can be determined from S_{FE} analysis. (A) OPU S_{FE} readings for erythrocytes (left) and polystyrene beads (right). (B) Histogram of the measurements in (A) considering the minimum and maximum intensities of the peaks. The plot shows two clusters containing erythrocytes at the rightmost region in blue and beads at the leftmost region in green. Reprinted with permission from ref 54. Copyright 2008 Elsevier.

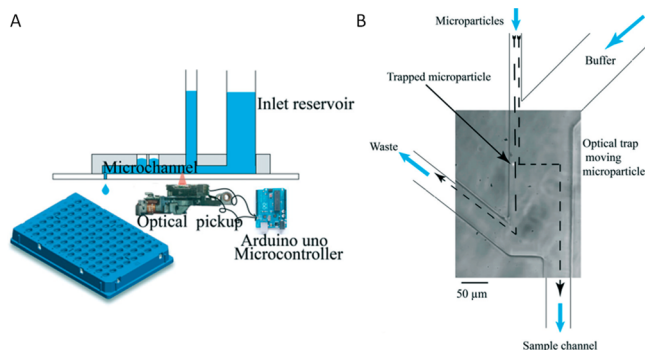

Figure 7. (A) Arduino board-controlled OPU generates an optical trap that isolates single microparticles inside the microfluidic device and delivers them as free-falling droplets to 96 well plates. (B) Particles flowing into this section follow streamlines into the waste channel, unless translated by the optical trap into the sample channel that leads into a droplet section. Reprinted with permission from ref 57. Copyright 2014 Royal Society of Chemistry.

image. Figure 8 shows the images obtained using a conventional high-end optical microscope (Figure 8A; magnification 1000 \times , phase contrast mode) and a laser imaging system based on a DVD OPU (Figure 8B; λ : 650 nm, NA: 0.6). The OPU-based system reveals detailed filament structures of the astrocytes and retrieves a higher contrast than the conventional optical microscope.

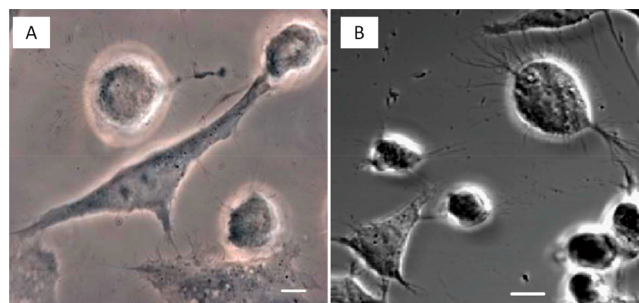

Figure 8. Astrocytes imaged by (A) high-end optical microscope in phase contrast mode (contrast: 0.143) and (B) OPU-based laser bioimaging system (contrast: 0.224) Reprinted with permission from ref 58. Copyright 2013 Japan Society for Analytical Chemistry.

Biosensing Using Transducers. Microelectromechanical systems (MEMS) cantilever-based biosensors are traditionally monitored using optical beam deflection,⁵⁹ which implies a complicated configuration. In contrast, OPUs provide submicron laser spots and subatomic sensing resolution⁹ to monitor MEMS^{28,29} and even nanoelectromechanical systems.⁶⁰ These cantilevers can be functionalized with receptor molecules as label-free biomolecular transducers that are immersed in an analyte and monitored by the OPU⁶¹ using static bending and frequency changes,⁶² as shown in Figure 9.

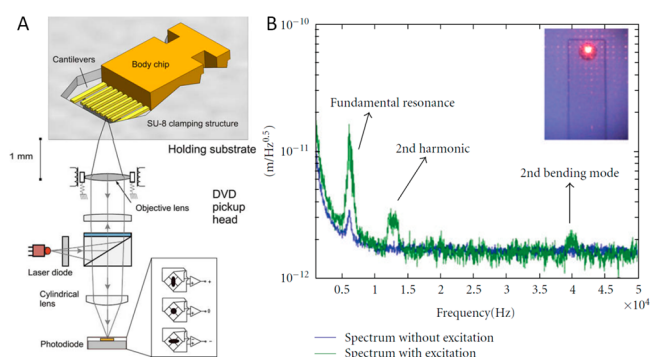

Figure 9. (A) SU-8 cantilever bending monitored by a DVD OPU.⁶¹ (B) Excited and thermal noise spectrum of a MEMS SU-8 cantilever monitored using the OPU.⁶² Reprinted with permission from refs 61 and 62. Copyright 2010 Elsevier and 2012 Hindawi, respectively.

In addition, a Blu-ray OPU-based vibrometer combining MEMS resonators inside microfluidic chips has been used to characterize biopolymer degradation under the action of enzymes in a controlled flow condition. An algorithm enables the OPU to measure 12 resonators within 4 min, thus dramatically reducing the degradation measurement time from 6 weeks to 8 h.⁶³

Furthermore, the OPU has a high sensing tolerance of $\pm 5^\circ$ to the cantilever initial angular tilt, allowing to scan cantilever-based biosensors on a rotating disc. This scanning system has a theoretical throughput of 500,000 cantilevers per second.⁶⁴ Moreover, the OPU scanning data has been used to reconstruct 3D topography and surface roughness of each cantilever to provide extra physical information for detection of pesticide derivative 2,6-dichlorobenzamide,⁶⁵ as shown in Figure 10. OPU cantilever-based biosensing has also been used in applications such as detection of vapor and liquid phase of 2,4-dinitrotoluene,⁶⁶ platelet derived growth factor

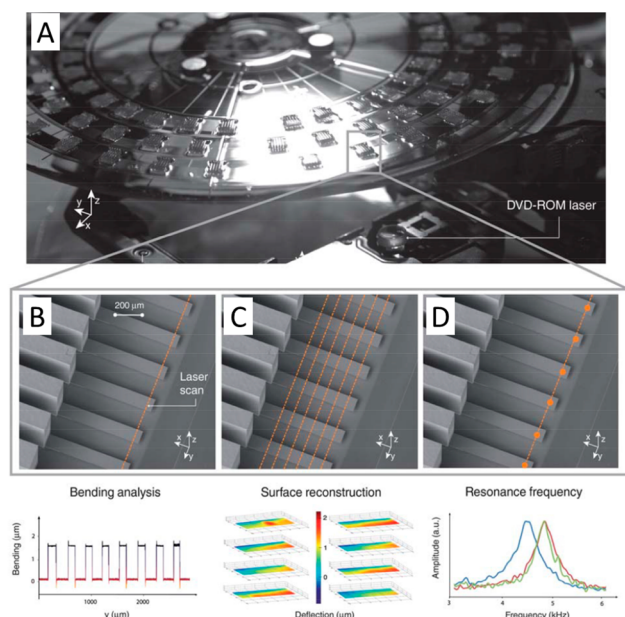

Figure 10. (A) Photograph of a DVD platform with integrated cantilever chips. The disc is fabricated from glass and SU-8 polymer. Scanning electron microscope images of gold-coated silicon microcantilevers using three data acquisition modes: (B) deflection, (C) surface 3D reconstruction, and (D) resonant frequency. Reprinted with permission from ref 65. Copyright 2011 Royal Society of Chemistry.

proteins,⁶⁷ and soluble urokinase plasminogen activator receptor inflammatory biomarker.⁶⁸

Interestingly, an OPU can be used for nanoscale biomolecule imaging beyond the diffraction limit by monitoring a MEMS AFM probe (Figure 11A),^{9,10,28,32} which has a tip with a typical radius of 10 nm. This OPU-based AFM is capable of imaging DNA in air or solution environments,³³ as shown in Figure 11B.

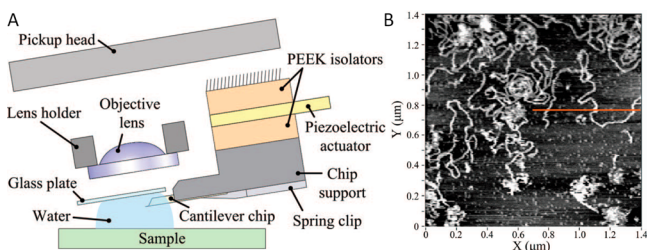

Figure 11. (A) Diagram of OPU-based AFM for bioimaging in liquid environment. (B) DNA sample with approximate height of 1.5 nm on a mica substrate immersed in an aqueous solution. Reprinted with permission from ref 33. Copyright 2013 AIP Publishing.

Modified OPU for Biosensing. A conventional DNA microarray scanner requires microscale precision for xy positioning, laser excitation, precise optics for focusing, and optical sensing. Consequently, the resulting system is expensive and bulky. By replacing the OPU components with a single-mode optical fiber and attaching an external sensing setup, the OPU can be used as the head of a scanning confocal microscope to enable fluorescent-based biosensing.⁶⁹

Figure 12 shows an OPU-based DNA microarray scanner. The OPU is coupled to a photomultiplier tube (PMT) detector through a dichroic filter, such as that shown in Figure

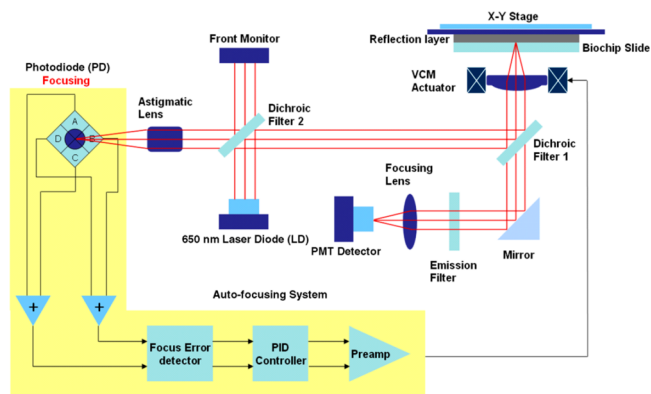

Figure 12. Diagram of OPU–PMT-based DNA microarray scanner. Reprinted with permission from ref 24. Copyright 2007 Springer Nature.

2. The OPU–PMT setup can acquire signals from fluorescent dyes excited by the OPU laser of 650 nm.²⁴ The OPU VCM provides dynamic autofocusing that enables higher detection performance than conventional microarray scanners, as shown in Figure 13. The OPU–PMT-based DNA microarray scanner

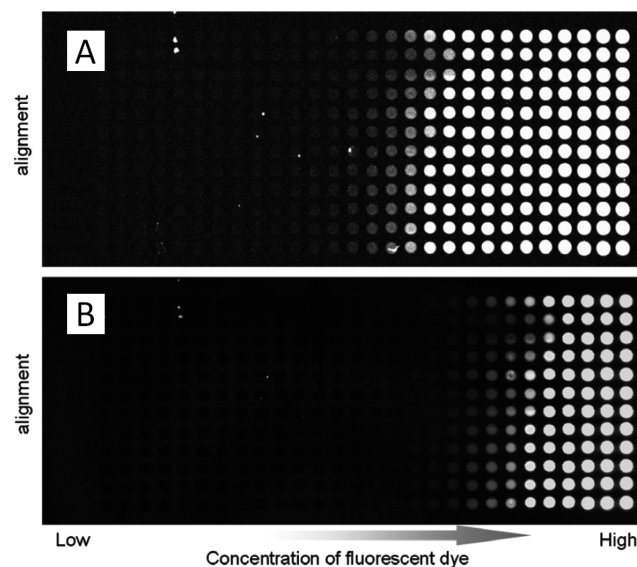

Figure 13. Detection image of a 32 12 Cy5 fluorescent dye calibration slide (A) with and (B) without VCM autofocusing. Reprinted with permission from ref 70. Copyright 2008 Elsevier.

has been successfully used to measure a commercial bacterial artificial chromosome oligonucleotide DNA chip and a 32 12 Cy5 fluorescent dye calibration slide (DS01).⁷⁰ Combined with microfluidic chips, OPU–PMT fluorescence detection can measure 2.5 μm fluorescent beads inside a microchannel,^{71,72} as shown in Figure 14.

To reduce the cost of using triple-wavelength laser diodes, some OPUs are endowed with dual-optics 780 and 650 nm lasers for CD/DVD, and a 405 nm laser for Blu-ray disc reading. These dual-optics OPUs have two objective lenses driven by the same VCM and can perform two separate optical sensing tasks while the objective lenses move synchronously. Figure 15 shows a diagram of a Blu-ray scanning microscope (BSM) comprising a dual-optics OPU coupled with a PMT sensor. The BSM uses the Blu-ray optical path to excite

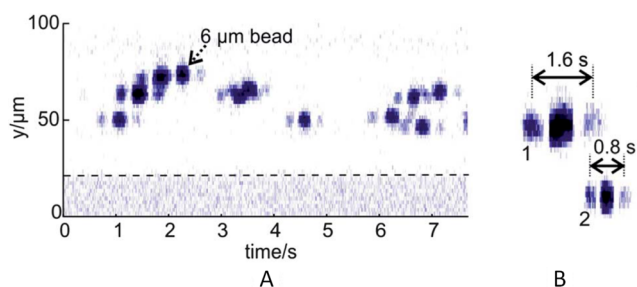

Figure 14. (A) Two-dimensional image of a microchannel cross-section containing multiple $6\ \mu\text{m}$ fluorescent beads. (B) Detection of two $2.5\ \mu\text{m}$ beads within the microchannel. Reprinted with permission from ref 72. Copyright 2012 Royal Society of Chemistry.

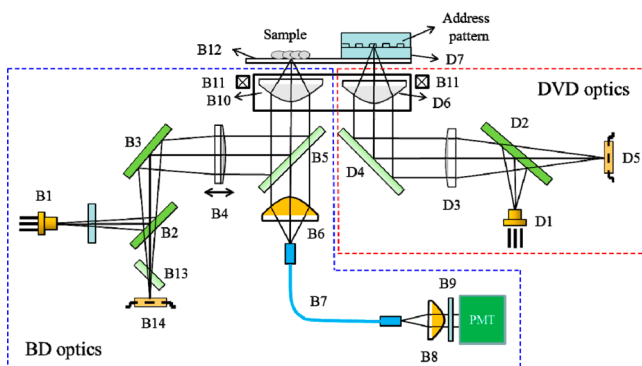

Figure 15. Diagram of BSM. The fluorescence signal passes through multimode fiber B7 and is collimated by collimator lens B8 and narrowband emission filter B9. D1, laser diode; D2, beam splitter; D3, collimator lens; D4, dichroic filter; D5, photodiode; D6, objective lens (NA: 0.6); D7, Al-coated address pattern; B1, blue laser diode; B2, B3, beam splitters; B4, collimator lens; B5, dichroic filter; B6, 4.34 mm focal lens; B10, objective lens (NA: 0.85); B11, lens holder. B12, cover glass; B13, collimator astigmatic plate; B14, photodetector. Reprinted with permission from ref 74. Copyright 2014 The Optical Society.

fluorescent light and capture a cell fluorescence image. Simultaneously, the DVD optical path is focused on an address-patterned area to monitor the xy scanning area and z -axis focusing.⁷³ This BSM setup has been successfully used to measure monkey-derived kidney epithelial cells and fibroblast cells stained with fluorophore phalloidin CF405 (Biotum, Inc., Fremont, CA, USA),⁷⁴ as shown in Figure 16. Moreover, the compact size of the BSM allows embedding it into a cell culture chamber.

The Blu-ray objective lens can also be replaced by a 488 nm optimized lens for imaging HA22T/VGH and VERO cell stained with phalloidin CF405 and Alexa Fluor 488 (Thermo Fisher Scientific, Waltham, MA, USA). The imaging depth can be adjusted in a range of $\pm 20\ \mu\text{m}$ through collimator lens B4 (Figure 15) inside the OPU.⁷⁵ Besides the PMT, the OPU can also equip an avalanche photodiode for Cy5 detection of stained cell fluorescence on a spinning disc.⁷⁶

Nanoparticle labeling can enhance the biomolecule signals up to 100 times.⁷⁷ Using this labeling technique, OPUs can scan the DNA microarray with an external photodiode, which is much less expensive than a PMT. Figure 17 shows an OPU–photodiode-based DNA microarray scanner to measure human papillomavirus with Ag-deposited Au nanoparticle labels.⁷⁸

Besides labeling, functionalized magnetic nanoparticle (MNP)-based antigen and antibody assay reactions can be

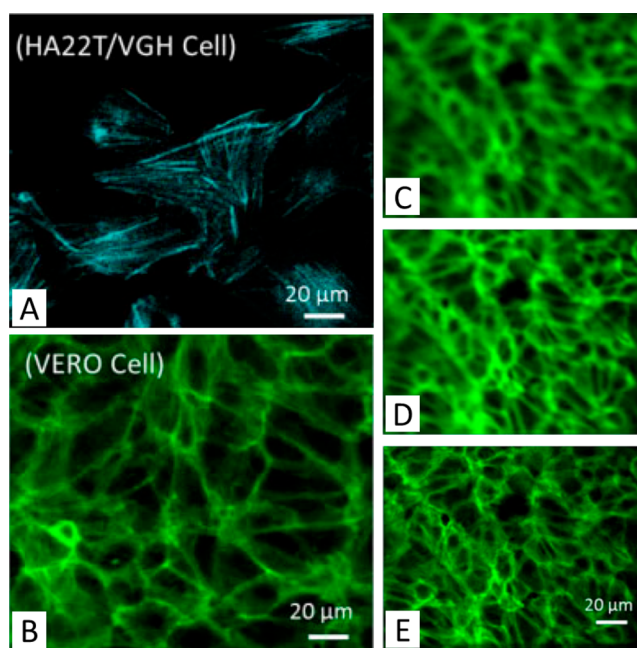

Figure 16. Fluorescence (A) HA22T/VGH (B) and VERO cell images stained with phalloidin CF405 and Alexa Fluor 488. Collimator lens B4 position of (C) 0, (D) 1, and (E) 2.5 mm. Reprinted with permission from ref 75. Copyright 2015 The Japan Society of Applied Physics.

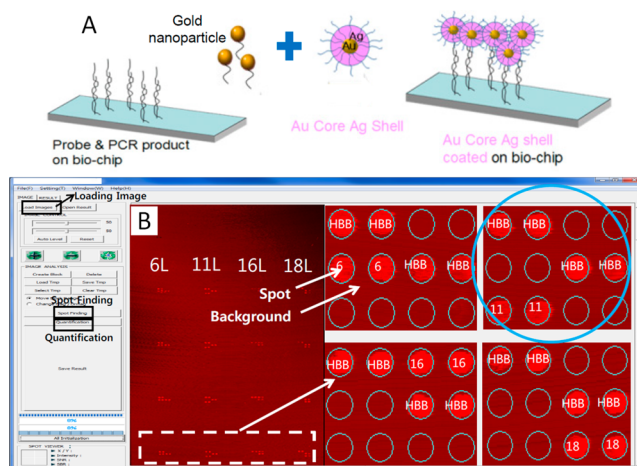

Figure 17. (A) Diagram for human papillomavirus genotyping microarray preparation. (B) Scanned image and calculated signal-to-noise ratio of human papillomavirus genotyping DNA with low-risk 6, 11, 16, and 18 types. Reprinted with permission from ref 78. Copyright 2014 The Optical Society.

opto-magnetically⁷⁹ monitored using a Blu-ray OPU (objective lens removed) instead of the expensive and bulky superconducting quantum interference devices.⁸⁰ Specifically, the Blu-ray OPU–MNP sensing shines a 405 nm parallel laser through a solution contains the MNPs, then acquiring reflection via a mirror. In addition, the Blu-ray OPU PDIC monitors the reflected laser frequency, phase, and amplitude while two coils apply an oscillating magnetic field to the MNPs. Combining Blu-ray OPU–MNP sensing with the lab-on-disc technique can carry out microliter-scale whole blood separation and antibody sensing⁸¹ in few minutes (Figures 18 and 19).

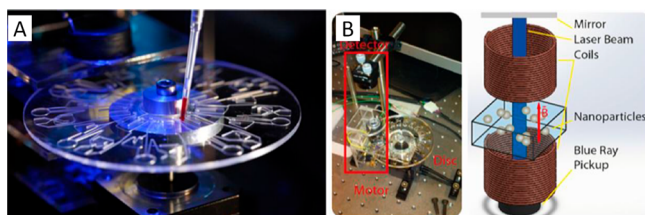

Figure 18. (A) Disk for magneto-optical measurements of protein biomarkers in full blood. (B) Platform comprising a motor, modified Blu-ray OPU, magnetic coils, reflection mirror, and customized electronic board for signal extraction. Reprinted with permission from ref 81. Copyright 2014 The Chemical and Biological Microsystems Society.

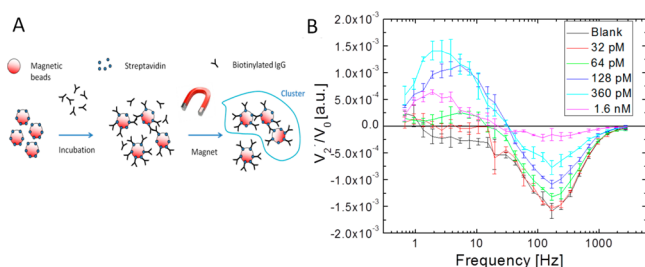

Figure 19. (A) Detection mechanism of biotinylated IgG (antistreptavidin) antibodies using streptavidin coated 100 nm MNPs. (B) Magneto-optical spectra measured on different pools with varying amount of IgG spiked into blood. Reprinted with permission from ref 81. Copyright 2014 The Chemical and Biological Microsystems Society.

Blu-ray OPU–MNP biosensing has also been applied on *Escherichia coli*, *Proteus mirabilis*, *Pseudomonas aeruginosa*,^{82,83} NS1 antigen of dengue,⁸⁴ and adenosine triphosphate.⁸⁵ This system features a compact size and can be integrated with commercial bioimaging systems to study the aptamer-conjugated MNPs⁸⁶ and the action mechanism of type 2 diabetes drugs.⁸⁷

CONCLUSIONS AND FUTURE PERSPECTIVES

CD/DVD/Blu-ray OPUs provide outstanding characteristics such as light weight, low cost, compact size, and high performance, which could be exploited to democratize and spread micro- and nanoscale biotechnology research for institutes in developing countries and citizen scientists. This review shows the possibility to open the black box of commercial OPUs and describes its mechanism, component characteristics, and several OPU-based bioapplications. We place special attention on gaining access to the OPU functions for various biosensing applications, and describe this access using circuits for three commercially available triple-wavelength OPUs in the Supporting Information.

High-speed Internet and solid-state drives have overcome optical drives for digital data transference and storage, with optical disc drives being discontinued from devices such as notebooks. Still, operative optical storage drives can be found in some music players and gaming consoles such as triple-wavelength Blu-ray OPUs are equipped in the Sony's PlayStation 4 (Sony Co., Tokyo, Japan) and XBOX One X (Microsoft Co., Redmond, WA, USA), which are devices that can operate for over 10 years. Moreover, repair assistance for OPUs can guarantee sustained scientific research for years and maybe decades to come.

Optical storage devices have a low cost, high durability, zero-energy storage, and compactness, which helps end users keep their information safe and private from enterprises (e.g., social networks), which can misuse sensitive information, and avoid big data cloud storage. Moreover, the femtosecond laser-based 360 TB with 13.8-billion-year storage time data recording technique proposed in ref 88 suggests an exciting future for optical storage technology. Of course, successful engineering, commercialization, and mass production processes will determine the future of this technology and reduce the costs for potential applications in further scientific research.

ASSOCIATED CONTENT

Supporting Information

The Supporting Information is available free of charge on the ACS Publications website at DOI: 10.1021/acssensors.8b00340.

Triple-wavelength OPU controller circuit designs (PDF)

AUTHOR INFORMATION

Corresponding Author

*E-mail: etehw@nanotech.dtu.dk.

Author Contributions

The manuscript was written through contributions of all authors. All authors have given approval to the final version of the manuscript.

Notes

The authors declare no competing financial interest.

ACKNOWLEDGMENTS

The authors would like to thank Mr. Chung-Hsiang Cheng and Mr. Christian Werner for the OPU driving circuits design. The authors also acknowledge the support from the European Research Council under the European Union's Seventh Framework Program (FP7/2007-2013), Grant no. 320535-HERMES and Center for Intelligent Drug Delivery and Sensing Using Microcontainers and Nanomechanics (IDUN) (grant no. DNRF122) funded by the Danish National Research Foundation and the Velux Foundations.

VOCABULARY

numerical aperture, a range of angles over which a lens can emit or collect light; refractive index, a dimensionless number of a material which describes speed of light propagates through the material; voice coil motor, an actuator driven by an electric current energized copper coil that operates inside a magnetic field; optical path difference, rays emitted from a point traveling through media with different ray path length; dichroic filter, color filter that selectively reflect certain light wavelengths; photodiode, a semiconductor-based component to convert light into an electrical signal; error correction code, sequence of numbers that corrects errors during data transmission

REFERENCES

- (1) Mark, D.; Haeberle, S.; Roth, G.; von Stetten, F.; Zengerle, R. Microfluidic Lab-on-a-Chip Platforms: Requirements, Characteristics and Applications. *Chem. Soc. Rev.* **2010**, *39*, 1153–1182.
- (2) Strohmeier, O.; Keller, M.; Schwemmer, F.; Zehnle, S.; Mark, D.; von Stetten, F.; Zengerle, R.; Paust, N. Centrifugal Microfluidic Platforms: Advanced Unit Operations and Applications. *Chem. Soc. Rev.* **2015**, *44*, 6187–6229.

- (3) Kido, H.; Maqueira, A.; Hammock, B. D. Disc-Based Immunoassay Microarrays. *Anal. Chim. Acta* **2000**, *411*, 1–11.
- (4) Morais, S.; Carrascosa, J.; Mira, D.; Puchades, R.; Maqueira, A. Microimmunoanalysis on Standard Compact Discs to Determine Low Abundant Compounds. *Anal. Chem.* **2007**, *79*, 7628–7635.
- (5) Bañuls, M.-J.; Gonzalez-Pedro, V.; Puchades, R.; Maqueira, A. PMMA Isocyanate-Modified Digital Discs as a Support of Oligonucleotide-Based Assays. *Bioconjugate Chem.* **2007**, *18*, 1408–1414.
- (6) Morais, S.; Tamarit-López, J.; Carrascosa, J.; Puchades, R.; Maqueira, A. Analytical Prospect of Compact Disc Technology in Immunosensing. *Anal. Bioanal. Chem.* **2008**, *391*, 2837–2844.
- (7) Ramachandriah, H.; Amasia, M.; Cole, J.; Sheard, P.; Pickhaver, S.; Walker, C.; Wirta, V.; Lexow, P.; Lione, R.; Russom, A. Lab-on-DVD: Standard DVD Drives as a Novel Laser Scanning Microscope for Image Based Point of Care Diagnostics. *Lab Chip* **2013**, *13*, 1578–1585.
- (8) Weng, S.; Li, X.; Li, Y.; Yu, H.-Z. Optical Disc Technology-Enable Analytical Devices: From Hardware Modification to Digitized Molecular Detection. *Analyst* **2016**, *141*, 6190–6201.
- (9) Hwu, E.-T.; Huang, K.-Y.; Hung, S.-K.; Hwang, I.-S. Measurement of Cantilever Displacement Using a Compact Disk/Digital Versatile Disk Pickup Head. *Jpn. J. Appl. Phys.* **2006**, *45*, 2368–2371.
- (10) Wang, W.-M.; Huang, K.-Y.; Huang, H.-F.; Hwang, I.-S.; Hwu, E.-T. Low-Voltage and High-Performance Buzzer-Scanner Based Streamlined Atomic Force Microscope System. *Nanotechnology* **2013**, *24*, 455503.
- (11) Rothenbach, C. A.; Gupta, M. C. High Resolution, Low Cost Laser Lithography Using a Blu-ray Optical Head Assembly. *Opt. Lasers Eng.* **2012**, *50*, 900–904.
- (12) Grey, F. Creativity Unleashed. *Nat. Nanotechnol.* **2015**, *10*, 480.
- (13) Lopez-Martinez, F.; Lombraña, D. L.; Grey, F.; Hwu, E.-T. A Crowdsourcing-Based Air Pollution Measurement System Using DIY Atomic Force Microscopes. *Hum. Comput.* **2016**, *3*, 235–241.
- (14) Blu-ray Disc Association, *White Paper Blu-Ray Disc™ Format-Physical Format Specifications for BD-ROM*, 2010; pp 1–48.
- (15) Wu, Q.; Feke, G. D.; Grober, R. D. Realization of Numerical Aperture 2.0 Using a Gallium Phosphide Solid Immersion Lens. *Appl. Phys. Lett.* **1999**, *75*, 4064–4066.
- (16) Hayashida, N.; Hirata, H.; Komaki, T.; Usami, M.; Ushida, T.; Itoh, H.; Yoneyama, K.; Utsunomiya, H. High-Performance Hard Coat for Cartridge-Free Blu-ray Disc. *Jpn. J. Appl. Phys.* **2003**, *42*, 750–753.
- (17) Hwu, E.-T. *Fundamentals of an Atomic Force Microscope Based on a Digital Versatile Disk Optical Pick-up Unit*, 2014; pp 31–36; <https://books.google.dk/books?id=2TlzAwAAQBAJ>.
- (18) Blu-ray Disc Association, *White Paper Blu-Ray Disc™ Format-Key Technologies*, 2004; pp 1–48.
- (19) Hsu, H.-S.; Tsai, P. J. A High Frequency and Amplitude Modulated CMOS Laser Diode Driver for Low Noise Readout Applications. *Analogue Integr. Circ. Sig. Process.* **2015**, *85*, 461–472.
- (20) Uchiyama, M.; Ebihara, T.; Omi, K.; Kitano, H.; Hoshino, I.; Mori, K. Development of Optical Pickup for Digital Versatile Disc Using Two-Wavelength-Integrated Laser Diode. *Jpn. J. Appl. Phys.* **2000**, *39*, 1549–1553.
- (21) Wu, C.-H.; Chen, W.-S. Injection Molding and Injection Compression Molding of Three-beam Grating of DVD Pickup Lens. *Sens. Actuators, A* **2006**, *125*, 367–375.
- (22) Tanaka, Y.; Komma, Y.; Shimizu, Y.; Shimazaki, T.; Murata, J.; Mizuno, S. Lens Design of Compatible Objective Lens for Blu-ray Disc and Digital Versatile Disc with Diffractive Optical Element and Phase Steps. *Jpn. J. Appl. Phys.* **2004**, *43*, 4742–4745.
- (23) Wang, W.-M.; Cheng, C.-H.; Molnar, G.; Hwang, I.-S.; Huang, K.-Y.; Danzebrink, H.-U.; Hwu, E.-T. Optical Imaging Module for Astigmatic Detection System. *Rev. Sci. Instrum.* **2016**, *87*, 053706.
- (24) Kim, K.-H.; Lee, S.-Y.; Kim, S.; Lee, S.-H.; Jeong, S.-G. A new DNA Chip Detection Mechanism Using Optical Pick-up Actuators. *Microsyst. Technol.* **2007**, *13*, 1359–1369.
- (25) Perraut, F.; Lagrange, A.; Pouteau, P.; Peyssonneaux, O.; Puget, P.; McGall, G.; Menou, L.; Gonzalez, R.; Labeye, P.; Ginot, F. A New Generation of Scanners for DNA Chips. *Biosens. Bioelectron.* **2002**, *17*, 803–813.
- (26) Matsui, T.; Shimomura, T. DVD Optical-head with Fluorescent Detection. In *Proceedings of Optical Data Storage Topical Meeting of IEEE Lasers & Electro-Optics Society*, April 23–26, 2006; pp 103–105.
- (27) Shimomura, T.; Izawa, C.; Matsui, T. Development of a Compact Optical System for Microarray Scanning Using a DVD Pickup Head. *Rev. Sci. Instrum.* **2008**, *79*, 035101.
- (28) Hwu, E.-T.; Hung, S.-K.; Yang, C.-W.; Huang, K.-Y.; Hwang, I.-S. Simultaneous Detection of Translational and Angular Displacements of Micromachined Elements. *Appl. Phys. Lett.* **2007**, *91*, 221908.
- (29) Hwu, E.-T.; Hung, S.-K.; Yang, C.-Y.; Huang, K.-Y.; Hwang, I.-S. Real-Time Detection of Linear and Angular Displacements with a Modified DVD Optical Head. *Nanotechnology* **2008**, *19*, 115501.
- (30) Zhao, X.; Li, X.; Cui, C.; Yu, H.-Z. DVD Diagnostic Software for reading Disc-Based Bioassays, a Comparative Study. *Sens. Actuators, B* **2014**, *195*, 116–122.
- (31) La Clair, J. J.; Burkart, M. D. Molecular Screening on a Compact Disc. *Org. Biomol. Chem.* **2003**, *1*, 3244–3249.
- (32) Weng, S.; Li, X.; Niu, M.; Ge, B.; Yu, H.-Z. Blu-Ray Technology-Based Quantitative Assays for Cardiac Markers: From Disc Activation to Multiplex Detection. *Anal. Chem.* **2016**, *88*, 6889–6896.
- (33) Liao, H.-S.; Huang, K.-Y.; Hwang, I.-S.; Chang, T.-J.; Hsiao, W. W.; Lin, H.-H.; Hwu, E.-T.; Chang, C.-S. Operation of Astigmatic-Detection Atomic Force Microscopy in Liquid Environments. *Rev. Sci. Instrum.* **2013**, *84*, 103709.
- (34) Wäldchen, S.; Lehmann, J.; Klein, T.; van de Linde, S.; Sauer, M. Light-Induced Cell Damage in Live-Cell Super-Resolution Microscopy. *Sci. Rep.* **2015**, *5*, 15348.
- (35) Kong, X.; Mohanty, S. K.; Stephens, J.; Heale, J. T.; Gomez-Godinez, V.; Shi, L. Z.; Kim, J.-S.; Yokomori, K.; Berns, M. W. Comparative Analysis of Different Laser Systems to Study Cellular Responses to DNA Damage in Mammalian Cells. *Nucleic Acids Res.* **2009**, *37*, e68.
- (36) Barathur, R.; Bookout, J.; Sreevatsan, S.; Gordon, J.; Werner, M.; Thor, G.; Worthington, M. New Disc-Based Technologies for Diagnostic and Research Applications. *Psychiatr. Genet.* **2002**, *12*, 193–206.
- (37) Yu, H.-Z.; Li, Y.; Ou, L. M.-L. Reading Disc Based Bioassays with Standard Computer Drives. *Acc. Chem. Res.* **2013**, *46*, 258–268.
- (38) Wang, H.; Ou, L. M. L.; Suo, Y.; Yu, H.-Z. Computer-Readable DNazyme Assay on Disc for ppb-Level Lead Detection. *Anal. Chem.* **2011**, *83*, 1557–1563.
- (39) Li, X.; Weng, S.; Ge, B.; Yao, Z.; Yu, H.-Z. DVD Technology-Based Molecular Diagnosis Platform: Quantitative Pregnancy Test on a Disc. *Lab Chip* **2014**, *14*, 1686–1694.
- (40) Zhang, L.; Li, X.; Li, Y.; Shi, X.; Yu, H.-Z. Indirect Competitive Assays on DVD for Direct Multiplex Detection of Drugs of Abuse in Oral Fluids. *Anal. Chem.* **2015**, *87*, 1896–1902.
- (41) Zhang, L.; Wong, J. X. H.; Li, X.; Li, Y.; Yu, H.-Z. Detection and Quantitation of Heavy Metal Ions on Bona Fide DVDs Using DNA Molecular Beacon Probes. *Anal. Chem.* **2015**, *87*, 5062–5067.
- (42) Li, X.; Shi, M.; Cui, C.; Yu, H.-Z. Inkjet-Printed Bioassays for Direct Reading with a Multimode DVD/Blu-Ray Optical Drive. *Anal. Chem.* **2014**, *86*, 8922–8926.
- (43) Shi, M.; Weng, S. S. H.; Li, X.; Yu, H.-Z. Digitized Molecular Detection on Off-the-shelf Blu-Ray Discs: Upgraded Resolution and Enhanced Sensitivity. *Sens. Actuators, B* **2017**, *242*, 79–86.
- (44) Arai, T.; Gopinath, S. C. B.; Mizuno, H.; Kumar, P. K. R.; Rockstuhl, C.; Awazu, K.; Tominaga, J. Toward Biological Diagnosis System Based on Digital Versatile Disc Technology. *Jpn. J. Appl. Phys.* **2007**, *46*, 4003–4006.
- (45) Potyrailo, R. A.; Morris, W. G.; Leach, A. M.; Sivavec, T. M.; Wisnudel, M. B.; Boyette, S. Analog Signal Acquisition from Computer

Optical Disk Drives for Quantitative Chemical Sensing. *Anal. Chem.* **2006**, *78*, 5893–5899.

(46) Potyrailo, R. A.; Morris, W. G.; Leach, A. M.; Hassib, L.; Krishnan, K.; Surman, C.; Wroczynski, R.; Boyette, S.; Xiao, C.; Shrikhande, P.; Agree, A.; Ceconie, T. Theory and Practice of Ubiquitous Quantitative Chemical Analysis Using Conventional Computer Optical Disk Drives. *Appl. Opt.* **2007**, *46*, 7007–7017.

(47) Morais, S.; Tortajada-Genaro, A. A.; Armandis-Chover, T.; Puchades, R.; Maquieira, A. Multiplexed Microimmunoassays on a Digital Versatile Disk. *Anal. Chem.* **2009**, *81*, 5646–5654.

(48) Gopinath, S. C. B.; Kumar, P. K. R.; Tominaga, J. A BioDVD Media with Multilayered Structure is Suitable for Analyzing Biomolecular Interactions. *J. Nanosci. Nanotechnol.* **2011**, *11*, 5682.

(49) Gopinath, S. C. B.; Suenaga, E.; Nagumo, O.; Kumar, P. K. R.; Tominaga, J. BioDVD Platform for Bio-Recognition; International Conference on Biological, Biomedical and Pharmaceutical Sciences of the International Association of Chemical, Biological & Medical Sciences Researchers, July 28–29, 2012.

(50) Lange, S. A.; Roth, G.; Wittmann, S.; Lacoste, T.; Vetter, A.; Grässle, J.; Kopta, S.; Kolleck, M.; Breiting, B.; Wick, M.; Horber, J. K. H.; Dübel, S.; Bernard, A. Measuring Biomolecular Binding Events with a Compact Disc Player Device. *Angew. Chem., Int. Ed.* **2006**, *45*, 270–273.

(51) Imaad, S. M.; Kulsharova, G.; Liu, G. L. Microparticle and cell counting with digital microfluidic compact disc using standard CD drive. *Lab Chip* **2011**, *11*, 1448–1456.

(52) Kostner, S.; Vellekoop, M. J. Detection of Single Biological Cells Using a DVD Pickup Head; The 14th International Conference on Solid-State Sensors, Actuators and Microsystems of IEEE Transducers, June 10–14, 2007.

(53) Kostner, S.; Vellekoop, M. J. Low Cost Cytometer Based on a DVD Pickup Head; 11th International Conference on Miniaturized Systems for Chemistry and Life Sciences of The Chemical and Biological Microsystems Society, October 7–11, 2007; pp 739–741.

(54) Kostner, S.; Vellekoop, M. J. Cell Analysis in a microfluidic cytometer applying a DVD pickup head. *Sens. Actuators, B* **2008**, *132*, 512–517.

(55) Kostner, S.; Vellekoop, M. J. Microsystems for Optical Cell Detection: Near versus Far Field. *Part. Part. Syst. Charact.* **2008**, *25*, 92–98.

(56) Kasukurti, A.; Potcoava, M.; Desai, S. A.; Eggleton, C.; Marr, D. W. M. Single-cell isolation using a DVD optical pickup. *Opt. Express* **2011**, *19*, 10377–10386.

(57) Kasukurti, A.; Eggleton, C. D.; Desai, S. A.; Disharoon, D. I.; Marr, D. W. M. A simple Microfluidic Dispenser for Single-Microparticle and Cell Samples. *Lab Chip* **2014**, *14*, 4673–4679.

(58) Hsiao, W.-W.; Liao, H.-S.; Lin, H.-H.; Lee, Y.-L.; Fan, C.-K.; Liao, C.-W.; Lin, P.-Y.; Hwu, E.-T.; Chang, C.-S. Biophysical Analysis of Astrocytes Apoptosis Triggered by Larval E/S Antigen from Cerebral Toxocarosis-Causing Pathogen *Toxocara Canis*. *Anal. Sci.* **2013**, *29*, 885–892.

(59) Fritz, J.; Baller, M. K.; Lang, H. P.; Rothuizen, H.; Vettiger, P.; Meyer, E.; Güntherodt, H.-J.; Gerber, Ch.; Gimzewski, J. K. Translating Biomolecular Recognition into Nanomechanics. *Science* **2000**, *288*, 316–318.

(60) Chen, C.-H.; Liao, H.-S.; Hwang, I.-S.; Hwu, E.-T.; Huang, K.-Y.; Larsen, P. E.; Schmid, S.; Boisen, A. Compact MEMS/NEMS Characterization Platform Using a DVD Optical Pick-Up Unit with Optical Imaging Function. *TechConnect Briefs* **2013**, *2*, 485–488.

(61) Bosco, F. G.; Hwu, E.-T.; Keller, S.; Greve, A.; Boisen, A. Self-aligned Cantilever Positioning for n-substrate Measurements Using DVD Pickup Head. *Microelectron. Eng.* **2010**, *87*, 708–711.

(62) Hwu, E.-T.; Liao, H.-S.; Bosco, F. G.; Chen, C.-H.; Keller, S. S.; Boisen, A.; Huang, K.-Y. An Astigmatic Detection System for Polymeric Cantilever-Based Sensors. *J. Sens.* **2012**, *2012*, 580939.

(63) Ceccacci, A. C.; Chen, C.-H.; Hwu, E.-T.; Morelli, L.; Bose, S.; Bosco, F. G.; Schmid, S.; Boisen, A. Blu-Ray-Based Micromechanical Characterization Platform for Biopolymer degradation Assessment. *Sens. Actuators, B* **2017**, *241*, 1303–1309.

(64) Hwu, E.-T.; Chen, C.-H.; Bosco, F. G.; Wang, W.-M.; Ko, H.-C.; Hwang, I.-S.; Boisen, A. High-performance Spinning Device for DVD-based Micromechanical Signal Transduction. *J. Micromech. Microeng.* **2013**, *23*, 045016.

(65) Bosco, F. G.; Hwu, E.-T.; Chen, C.-H.; Keller, S.; Bache, M.; Jakobsen, M. H.; Hwang, I.-S.; Boisen, A. High Throughput Label-free Platform for Statistical Bio-molecular Sensing. *Lab Chip* **2011**, *11*, 2411–2146.

(66) Bosco, F. G.; Bache, M.; Hwu, E.-T.; Chen, C.-H.; Andersen, S. S.; Nielsen, K. A.; Keller, S. S.; Jeppesen, J. O.; Hwang, I.-S.; Boisen, A. Statistical Analysis of DNT Detection Using Chemically Functionalized Microcantilever Arrays. *Sens. Actuators, B* **2012**, *171–172*, 1054–1059.

(67) Bosco, F. G.; Bache, M.; Yang, J.; Chen, C.-H.; Hwu, E.-T.; Lin, Q.; Boisen, A. Micromechanical PDGF Recognition via Lab-on-a-disc Aptasensor Arrays. *Sens. Actuators, A* **2013**, *195*, 154–159.

(68) Bache, M.; Bosco, F. G.; Brogger, A. L.; Frohling, K. B.; Alstrom, T. S.; Hwu, E.-T.; Chen, C.-H.; Eugen-Olsen, J.; Hwang, I.-S.; Boisen, A. Nanomechanical Recognition of Prognostic Biomarker suPAR with DVD-ROM Optical Technology. *Nanotechnology* **2013**, *24*, 444011.

(69) Benschop, J.; van Rosmalen, G. Confocal Compact Scanning Optical Microscope Based on Compact Disc Technology. *Appl. Opt.* **1991**, *30*, 1179–1184.

(70) Kim, K.-H.; Lee, S.-Y.; Kim, S.; Jeong, S.-G. DNA Microarray Scanner with a DVD Pick-up Head. *Curr. Appl. Phys.* **2008**, *8*, 687–691.

(71) Segerink, L. I.; Koster, M. J.; Sprenkels, A. J.; Vermes, I.; Berg, A. A Cheap 2D Fluorescence Detection System for μ m-sized Beads on-chip; 15th International Conference on Miniaturized Systems for Chemistry and Life Sciences of The Chemical and Biological Microsystems Society, October 2–6, 2011.

(72) Segerink, L. I.; Koster, M. J.; Sprenkels, A. J.; van den Berg, A. A Low-cost 2D Fluorescence Detection System for μ -sized Beads on-chip. *Lab Chip* **2012**, *12*, 1780–1783.

(73) Yu, H.-C.; Lyu, H.-C.; Lee, Y.-C.; Ju, J.-J.; Kao, F.-J. A Novel Optical Scanner Based on Blue-ray DVD Pick-up Head for Analysis of Multifunctional Bio-information; Focus on Microscopy conference, April 17–20, 2011.

(74) Tsai, R.-Y.; Chen, J.-P.; Lee, Y.-C.; Huang, C.-C.; Huang, T.-T.; Chiang, H.-C.; Cheng, C.-M.; Lo, F.-H.; Chang, S.-L.; Weng, K.-Y.; Chung, L.-P.; Chen, J.-C.; Tiao, G. Position-addressable Digital Laser Scanning Point Fluorescence Microscopy with a Blu-ray Disk Pickup Head. *Biomed. Opt. Express* **2014**, *5*, 427–438.

(75) Tsai, R.-Y.; Chen, J.-P.; Lee, Y.-C.; Chiang, H.-C.; Cheng, C.-M.; Huang, C.-C.; Huang, T.-T.; Cheng, C.-T.; Tiao, G. Cell Depth Imaging by Point Laser Scanning Fluorescence Microscopy with an Optical Disk Pickup Head. *Jpn. J. Appl. Phys.* **2015**, *54*, 09MD01.

(76) Huang, D.-R.; Ju, J.-J.; Lee, Y.-C.; Chen, J.-S.; Lo, F.-H.; Chang, S.-L. New Disc Format for Biosensing by Using Optical Pick-Up Head System. *IEEE Trans. Magn.* **2014**, *50*, 3500704.

(77) Taton, T. A.; Mirkin, C. A.; Letsinger, R. L. Scanometric DNA Array Detection with Nanoparticle Probes. *Science* **2000**, *289*, 1757–1760.

(78) Li, X. Z.; Kim, S.; Cho, W.; Lee, S.-Y. Optical Detection of Nanoparticle-enhanced Human Papillomavirus Genotyping Microarrays. *Biomed. Opt. Express* **2013**, *4*, 187–192.

(79) Donolato, M.; Antunes, P.; Bejhed, R. S.; Zardan Gomez de la Torre, T.; Osterberg, F. W.; Stromberg, M.; Nilsson, M.; Stromme, M.; Svedlindh, P.; Hansen, M. F.; Vavassori, P. Novel Readout Method for Molecular Diagnostic Assays Based on Optical Measurement of Magnetic Nanobead Dynamics. *Anal. Chem.* **2015**, *87*, 1622–1629.

(80) Koh, I.; Josephson, L. Magnetic Nanoparticle Sensors. *Sensors* **2009**, *9*, 8130–8145.

(81) Donolato, M.; Antunes, P.; Burger, R.; Bosco, F.; Olsson, M.; Yang, J.; Chen, C.-H.; Lin, Q.; Hwu, E.-T.; Boisen, A.; Hansen, M. F. Lab-On-Blu-ray: Low-Cost Analyte Detection on a Disk; 18th International Conference on Miniaturized Systems for Chemistry

and Life Sciences of The Chemical and Biological Microsystems Society, October 26–30, 2014; pp 2044–2046.

(82) Mezger, A.; Fock, J.; Antunes, P.; Osterberg, F. W.; Boisen, A.; Nilsson, M.; Hansen, M. F.; Ahlford, A.; Donolato, M. Scalable DNA-Based Magnetic Nanoparticle Agglutination Assay for Bacterial Detection in Patient Samples. *ACS Nano* **2015**, *9*, 7374–7382.

(83) Donolato, M.; Antunes, P.; Zardan Gomez de la Torre, T.; Hwu, E.-T.; Chen, C.-H.; Burger, R.; Rizzi, G.; Bosco, F. G.; Stromme, M.; Boisen, A.; Hansen, M. F. Quantification of Rolling Cycle Amplified DNA Using Magnetic Nanobeads and a Blu-ray Optical Pick-p Unit. *Biosens. Bioelectron.* **2015**, *67*, 649–655.

(84) Antunes, P.; Watterson, D.; Parmvi, M.; Burger, R.; Boisen, A.; Young, P.; Cooper, M. A.; Hansen, M. F.; Ranzoni, A.; Donolato, M. Quantification of NS1 Dengue Biomarker in Serum via Optomagnetic Nanocluster Detection. *Sci. Rep.* **2015**, *5*, 16145.

(85) Yang, J.; Donolato, M.; Pinto, A.; Bosco, F. G.; Hwu, T.-T.; Chen, C.-H.; Alstrom, T. S.; Lee, G.-H.; Schafer, T.; Vavassori, P.; Boisen, A.; Lin, Q.; Hansen, M. F. Blu-Ray Based Optomagnetic Aptasensor for Detection of Small Molecules. *Biosens. Bioelectron.* **2016**, *75*, 396–403.

(86) Uddin, R.; Burger, R.; Donolato, M.; Fock, J.; Creagh, M.; Hansen, F. M.; Boisen, A. Lab-on-a-disc Agglutination Assay for Protein Detection by Optomagnetic Readout and Optical Imaging Using Nano- and Micro-sized Magnetic Beads. *Biosens. Bioelectron.* **2016**, *85*, 351–357.

(87) Uddin, R.; Nur-E-Habiba; Rena, G.; Hwu, E.-T.; Boisen, A. New Evidence for the Mechanism of Action of a Type-2 Diabetes Drug Using a Magnetic Bead-Based Automated Biosensing Platform. *ACS Sens.* **2017**, *2*, 1329–1336.

(88) Zhang, J.; Gecevicius, M.; Beresna, M.; Kazansky, P. Seemingly Unlimited Lifetime Data Storage in Nanostructured Glass. *Phys. Rev. Lett.* **2014**, *112*, 033901.