

Research

The ESAT-6 gene cluster of *Mycobacterium tuberculosis* and other high G+C Gram-positive bacteria

Nico C Gey van Pittius*, Junaid Gamielien†, Winston Hide†, Gordon D Brown‡, Roland J Siezen§ and Albert D Beyers*

Addresses: *US/MRC Centre for Molecular and Cellular Biology, Department of Medical Biochemistry, University of Stellenbosch, Tygerberg, 7505, South Africa. †South African National Bioinformatics Institute (SANBI), University of the Western Cape, Bellville, 7535, South Africa. ‡Sir William Dunn School of Pathology, University of Oxford, South Parks Road, Oxford OX1 3RE, UK. §Center for Molecular and Biomolecular Informatics, University of Nijmegen, 6525ED Nijmegen, The Netherlands.

Correspondence: Nico C Gey van Pittius. E-mail: ngvp@sun.ac.za

Published: 19 September 2001

Genome **Biology** 2001, **2**(10):research0044.1-0044.18

The electronic version of this article is the complete one and can be found online at <http://genomebiology.com/2001/2/10/research/0044>

© 2001 Gey van Pittius et al., licensee BioMed Central Ltd
(Print ISSN 1465-6906; Online ISSN 1465-6914)

Received: 9 June 2001

Revised: 6 August 2001

Accepted: 22 August 2001

Abstract

Background: The genome of *Mycobacterium tuberculosis* H37Rv has five copies of a cluster of genes known as the ESAT-6 loci. These clusters contain members of the CFP-10 (*lhp*) and ESAT-6 (*esat-6*) gene families (encoding secreted T-cell antigens that lack detectable secretion signals) as well as genes encoding secreted, cell-wall-associated subtilisin-like serine proteases, putative ABC transporters, ATP-binding proteins and other membrane-associated proteins. These membrane-associated and energy-providing proteins may function to secrete members of the ESAT-6 and CFP-10 protein families, and the proteases may be involved in processing the secreted peptide.

Results: Finished and unfinished genome sequencing data of 98 publicly available microbial genomes has been analyzed for the presence of orthologs of the ESAT-6 loci. The multiple duplicates of the ESAT-6 gene cluster found in the genome of *M. tuberculosis* H37Rv are also conserved in the genomes of other mycobacteria, for example *M. tuberculosis* CDC1551, *M. tuberculosis* 210, *M. bovis*, *M. leprae*, *M. avium*, and the avirulent strain *M. smegmatis*. Phylogenetic analyses of the resulting sequences have established the duplication order of the gene clusters and demonstrated that the gene cluster known as region 4 (Rv3444c-3450c) is ancestral. Region 4 is also the only region for which an ortholog could be found in the genomes of *Corynebacterium diphtheriae* and *Streptomyces coelicolor*.

Conclusions: Comparative genomic analysis revealed that the presence of the ESAT-6 gene cluster is a feature of some high-G+C Gram-positive bacteria. Multiple duplications of this cluster have occurred and are maintained only within the genomes of members of the genus *Mycobacterium*.

Background

Mycobacterium tuberculosis remains a serious threat to human health and in spite of significant investment in research on this organism, the mechanisms of its pathogenicity

are still not clearly understood. One strategy used to determine these mechanisms is to compare the presence and absence of genes in different species (for example, virulent and avirulent) and extrapolate these differences to variation

in phenotype. The genomes of *M. tuberculosis* H37Rv, *M. tuberculosis* H37Ra, *M. bovis* and the attenuated *M. bovis* BCG have been compared in different combinations using a variety of methods (subtractive genomic hybridization [1], bacterial artificial chromosome (BAC) restriction profile analysis [2-5], BAC arrays [6], DNA microarrays [7] and Southern blotting [8]). This has identified a number of regions of difference (RD) between the various organisms.

One of these regions, designated the RD1 (region of difference 1) deletion region [1], is a 9,505 bp region absent in all *M. bovis* BCG strains. RD1 is commonly thought to be the primary deletion that occurred during the serial passage of *M. bovis* by Calmette and Guérin between 1908 and 1921, and is thus thought possibly to be responsible for the primary attenuation of *M. bovis* to *M. bovis* BCG [5,7]. Consequently, the genes contained in RD1 have been the object of a number of studies focusing on diagnosis of *M. tuberculosis* infection, the search for efficient vaccine candidates and virulence [9-12]. RD1 encompasses the genes Rv3871 to Rv3879c (annotation according to [13]), which include the genes for the 6 kDa early-secreted antigenic target ESAT-6 (*esx* or *esat-6*) and L45 homologous protein CFP-10 (*lhp*) [14,15]. The *esat-6* and *lhp* genes are situated immediately adjacent to each other and encode potent T-cell antigens that are secreted but lack detectable secretion signals [16,17].

During the genome sequencing of *M. tuberculosis* H37Rv, Cole *et al.* [13] identified at least 11 additional genes encoding small proteins of approximately 100 amino acids that share sequence similarities with ESAT-6, and grouped them into the *esat-6* gene family. In addition, they found several small genes with similarity to *lhp* (which encodes the protein CFP-10) that are also situated directly adjacent to the *esat-6* family genes. Sequence analyses indicated that the *lhp* family members belong to and extend this *esat-6* gene family. It was also found that the *lhp* gene is co-transcribed and thus forms part of an operon with *esat-6* [15].

The genes encoding the originally annotated CFP-10 and ESAT-6 proteins within the RD1 deletion region lie in a cluster of 12 other genes (encompassing the deletion region), which seems to have been duplicated five times in the genome of *M. tuberculosis*. The duplicated gene clusters have been previously described as the ESAT-6 loci in an analysis of the proteome of *M. tuberculosis* [18]. An examination of the sets of genes in the clusters reveals that each of the clusters also contains (in addition to a copy of *esat-6* and *lhp*), genes encoding putative ABC transporters (integral inner-membrane proteins), ATP-binding proteins, subtilisin-like membrane-anchored cell-wall-associated serine proteases (the mycosins [19]), and other amino-terminal membrane-associated proteins [18].

We have compared sequences to establish the relationship between the multiple copies of the ESAT-6 gene cluster. Our

results show that the ESAT-6 gene cluster is of ancient origin, is present in, and restricted to, the genomes of other members of the high G+C Gram-positive bacteria such as *Corynebacterium diphtheriae* and *Streptomyces coelicolor*, and is duplicated multiple times in *M. tuberculosis* and other mycobacteria. We discuss the conservation of this gene cluster in the context of its possible functional importance and its use in diagnosis of mycobacterial infection.

Results

Individual gene families and genomic organization in *M. tuberculosis*

The five ESAT-6 gene clusters present in *Mycobacterium tuberculosis* H37Rv were named region 1 (Rv3866-Rv3883c), 2 (Rv3884c-Rv3895c), 3 (Rv0282-Rv0292), 4 (Rv3444c-Rv3450c) and 5 (Rv1782-Rv1798), consistent with the arbitrary numbering system used previously to classify the five mycosin (subtilisin-like serine protease) genes identified from these regions [19]. Orthologs of the ESAT-6 gene clusters of *M. tuberculosis* H37Rv could be identified in the genomes of eight other strains and species belonging to the genus *Mycobacterium*, as well as in two species belonging to other genera (Table 1). Up to 12 different genes representing different gene families were identified in the five gene cluster regions and were designated families A to L according to their position in region 1 (Table 2).

Figure 1 shows a schematic representation of the genomic organization of the gene families present in each of the five ESAT-6 cluster regions of *M. tuberculosis*. Annotations and descriptions of single genes in these regions can be found at [20]. Regions 1 and 2 are situated directly adjacent to each other in the genome and are transcribed in opposite directions. In both regions 1 and 5 the large gene belonging to family D (encoding the ATPase protein) has been disrupted by an insertion (Figure 1). This insertion has resulted in an in-frame stop codon, giving rise to two smaller genes (containing all the motifs of the larger homolog) located directly adjacent to each other. The gene positions of members of families C, D, G and H are maintained in all five regions (see Figure 1), whereas most of the families that are not present in region 4 seem to be more flexible with regard to their position within the gene clusters (families A, B, I and L). There are also genes present within some of the ESAT-6 gene clusters that do not have any homologs in the other clusters, suggesting subsequent insertions or deletions from the ancestral region (indicated by black arrows in Figure 1, see also Table 2).

The *esat-6/lhp* operon is not only present in the ESAT-6 gene clusters, but is distributed as six additional copies in the genome of *M. tuberculosis* (Figure 2). In four cases, the *esat-6/lhp* operon is flanked by *ppe* and *pe* genes (encoding proteins that have proline-proline-glutamic acid (PPE) and proline-glutamic acid (PE) motifs, respectively), indicating

Table 1

Bacterial genome sequencing projects of species and strains containing ESAT-6 gene clusters

	Organism	Strain	Status	Last access date	Last update	Sequencing center(s)	References
1	<i>Mycobacterium tuberculosis</i>	H37Rv	Completed	5-Mar-2001	11-Jun-1998	Sanger Centre/ Pasteur Institute	[13,20,47]
2	<i>M. tuberculosis</i>	CDC1551 (Oshkosh strain or CSU#93)	Completed	5-Mar-2001	28-Jan-1999	TIGR	[48] R.D. Fleischmann et al., unpublished data
3	<i>M. tuberculosis</i>	210	Partial sequencing project completed, no additional sequencing anticipated.	21-May-2001	4-May-2001	TIGR	[49]
4	<i>M. bovis</i>	AF2122/97 (spoligotype 9)	Shotgun in progress	5-Mar-2001	29-Aug-2000	Sanger Centre/ Pasteur Institute	[50]
5	<i>M. bovis</i> BCG	Pasteur 1173P2	Unfinished	-	-	Pasteur Institute	[51]
6	<i>M. leprae</i>	TN	Completed	7-Mar-2001	21-Feb-2001	Sanger Centre/ Pasteur Institute	[25,52,53]
7	<i>M. avium</i>	104	Gap closure finished	6-Mar-2001	22-Feb-2001	TIGR	[49]
8	<i>M. paratuberculosis</i>	K10	Unfinished (6.9 x coverage)	6-Mar-2001	25-Feb-2001	University of Minnesota	[29]
9	<i>M. smegmatis</i>	MC ² 155	Shotgun completed, assembly	6-Mar-2001	22-Feb-2001	TIGR	[49]
10	<i>Corynebacterium diphtheriae</i>	NCTC13129	Finishing/gap closure	5-Mar-2001	26-Feb-2001	Sanger Centre	[54]
11	<i>Streptomyces coelicolor</i>	A3(2)	Cosmid sequencing	5-Mar-2001	1-Mar-2001	Sanger Centre	[55]

possible linked duplication between the *esat-6/lhp* operon and the *pe/ppe* gene pair.

ESAT-6 gene cluster identification in other mycobacteria

Table 2 presents the results of the similarity searches and all available data for the 12 identified gene families present in the different regions. All the mycobacteria currently being sequenced contain multiple copies of these regions in their genomes. As these different copies are also found in the same respective genomic locations (corresponding flanking genes) in all the mycobacteria, it indicates that the duplication events took place prior to the divergence of the different species.

M. tuberculosis CDC1551, *M. tuberculosis* 210 and *M. bovis*

The genomes of the *M. tuberculosis* CDC1551 and 210 clinical strains as well as the genome of *M. bovis* contain all five of the ESAT-6 gene cluster regions present in the genome of *M. tuberculosis* H37Rv (sharing between 99 and 100% similarity to *M. tuberculosis* H37Rv at protein level). It is interesting to note, however, that two of the genes present in region 2 in CDC1551 (MT4000 and MT4001) contain frameshifts in their sequences, indicating that they and the rest of the region may no longer be functional in CDC1551. Part of region 2 (a 2,405 bp fragment containing Rv3887c,

Rv3888c and Rv3889c) is also deleted in certain strains of *M. bovis* only, including the strain AF2122/97 that is currently being sequenced [21]. An in-frame stop codon found in Rv1792 (family G) is also present in the orthologs in CDC1551 (MT1841) and strain 210 (MTB196G), indicating that the mutation may have taken place before divergence of the three strains. Two of the H37Rv genes as well as the strain 210 family D genes (in regions 1 and 5) have acquired in-frame stop codons, resulting in two genes lying adjacent to each other, whereas the family D Rv1783 and Rv1784 orthologs in CDC1551 are still one intact gene (MT1833). The orthologs of this gene in *M. bovis* (MB771.1D), *M. leprae* (ML1543), *M. avium* (MA221D), and *M. paratuberculosis* (MP1783) are also intact, implying that the mutation in the H37Rv and strain 210 orthologs must have occurred after divergence of the three *M. tuberculosis* strains.

M. leprae

Figure 3 shows a schematic representation of the genomic organization of the respective gene families present in each of the five ESAT-6 gene clusters of *M. leprae*. The genome sequence of *M. leprae* contains functional copies of two of the five ESAT-6 gene cluster regions (regions 1 and 3, which have between 50 and 70% similarity to *M. tuberculosis* H37Rv at protein level). Most of the genes from region 2 are deleted, and all the remaining genes in this region have

Table 2**Presence of genes in gene clusters of all available finished and unfinished genome sequences**

Gene family	Description	Protein size (in <i>M.tb</i>)	ESAT-6 cluster region	Presence and names of genes in each species				
				<i>M. tuberculosis</i> H37Rv	<i>M. tuberculosis</i> CDC1551 (CSU#93)	<i>M. tuberculosis</i> * 210	<i>M. bovis</i> * AF2122/97 (spoligotype 9)	<i>M. bovis</i> * BCG Pasteur I173P2
A	ABC transporter family signature, 19-27% homology	283	1	Rv3866	MT3980	ND	MB851A	No sequence data
		276	2	Rv3889c	MT4004	MTB12A	MB727.3A (partly deleted #)	No sequence data
		295	3	Rv0289	MT0302	MTB203A	MB548A	No sequence data
		-	4	No duplication	No duplication	No duplication	No duplication	No duplication
		300	5	Rv1794	MT1843	MTB196A	MB557A	No sequence data
B	AAA+ class ATPases, CBXX/CFQX family, SpoVK, 1x ATP/GTP-binding site, 29-39% homology	573	1	Rv3868	MT3981	MTB44B	MB851B	No sequence data
		619	2	Rv3884c	MT3999	MTB12B	MB727.1B	No sequence data
		631	3	Rv0282	MT0295	MTB23B	MB672B	No sequence data
		-	4	No duplication	No duplication	No duplication	No duplication	No duplication
		610	5	Rv1798	MT1847	MTB196B	MB542B	No sequence data
C	Amino-terminal transmembrane protein, possible ATP/GTP-binding motif, 31-41% homology	480	1	Rv3869	MT3982	MTB44C	MB851C	No sequence data
		495	2	Rv3895c	MT4011	MTB136C	MB780.1C	No sequence data
		538	3	Rv0283	MT0296	MTB23C	MB672C	No sequence data
		470	4	Rv3450c	MT3556	MTB45C	MB493.1C	No sequence data
		506	5	Rv1782	MT1832	MTB46C	MB771.1C	No sequence data
D	DNA segregation ATPase, ftsK chromosome partitioning protein, SpoIIIE, yukA, 3x ATP/GTP-binding sites, 2x amino-terminal transmembrane protein, 28-39% homology	747 + 591	1	Rv3870+71	MT3983+85	MTB44Da+Db	MB851D	MB851D (partly deleted)
		1396	2	Rv3894c	MT4010	MTB3D	MB780.1D	No sequence data
		1330	3	Rv0284	MT0297	MTB23D	MB672D	No sequence data
		1236	4	Rv3447c	MT3553	MTB45D	MB585.1D	No sequence data
		435 + 932	5	Rv1783+84	MT1833	MTB46Da+Db	MB771.1D	No sequence data
E	PE, 18-90% homology	99	1	Rv3872	MT3986	MTB44E	MB851E	Deleted
		77	2	Rv3893c	MT4008	MTB3E	MB780.1E	No sequence data
		102	3	Rv0285	MT0298	MTB23E	MB389E	No sequence data
		-	4	No duplication	No duplication	No duplication	No duplication	No duplication
		99 & 99	5	Rv1788 & 91	MT1837 & 40	MTB196Ea & Eb	MB771.0E & MB557E	No sequence data
F	PPE, 19-88% homology	368	1	Rv3873	MT3987	MTB44F	MB851F	Deleted
		399	2	Rv3892c	MT4007	MTB3F	MB780.1F	No sequence data
		513	3	Rv0286	MT0299	MTB472F	MB528F	No sequence data
		-	4	No duplication	No duplication	No duplication	No duplication	No duplication
		365, 393 & 350	5	Rv1787 & 89 & 90	MT1836 & 38 & 39	MTB196Fa & Fb & Fc	MB771.0Fa & Fb & MB557F	No sequence data
G	Ihp or CFP-10, also MTSA-10, grouped into ESAT-6 family, potent secreted T-cell antigens, 9-32% homology	100	1	Rv3874	MT3988	MTB44G	MB851G	Deleted
		107	2	Rv3891c	MT4006	MTB12G	MB727.3G	No sequence data
		97	3	Rv0287	MT0300	MTB472G	MB548G	No sequence data
		125	4	Rv3445c	MT3550	MTB45G	MB585.0G	No sequence data
		98	5	Rv1792 (Stop)	MT1841 (Stop)	MTB196G (Stop)	MB557G	No sequence data

Table 2 (continued)

Gene family	Description	Protein size (in <i>M.tb</i>)	ESAT-6 cluster region	Presence and names of genes in each species					
				<i>M. tuberculosis</i> H37Rv	<i>M. tuberculosis</i> CDC1551 (CSU#93)	<i>M. tuberculosis</i> * 210	<i>M. bovis</i> * AF2122/97 (spoligotype 9)	<i>M. bovis</i> * BCG Pasteur I173P2	
H	ESAT-6 family, cfp7, L45 or l-esat, also Mtb9.9 family, potent secreted T-cell antigens, 15-27% homology	95	1	Rv3875	MT3989	MTB44H	MB851H †	Deleted	
		95	2	Rv3890c	MT4005	MTB12H	MB727.3H	No sequence data	
		96	3	Rv0288	MT0301	MTB203H	MB548H	No sequence data	
		100	4	Rv3444c	MT3549	MTB45H	MB585.0H	No sequence data	
		94	5	Rv1793	MT1842	MTB196H	MB557H	No sequence data	
I	ATPases involved in chromosome partitioning, 1x ATP/GTP-binding motif, -33% homology-	666	1	Rv3876	MT3990	MTB60I	MB477I	Deleted	
		341	2	Rv3888c	MT4003	MTB12I	Deleted #	No sequence data	
		-	3	No duplication	No duplication	No duplication	No duplication	No duplication	
		-	4	No duplication	No duplication	No duplication	No duplication	No duplication	
		-	5	No duplication	No duplication	No duplication	No duplication	No duplication	
J	Integral inner membrane protein, binding-protein-dependent transport systems inner membrane component signature, putative transporter protein, 19-27% homology	511	1	Rv3877	MT3991	MTB369J	MB477J	Deleted	
		509	2	Rv3887c	MT4002	MTB12J	MB727.3J	No sequence data	
		472	3	Rv0290	MT0303	MTB203J	MB548J	No sequence data	
		467	4	Rv3448	MT3554	MTB45J	MB585.1J	No sequence data	
		503	5	Rv1795	MT1844	MTB196J	MB506J	No sequence data	
K	Mycosins, subtilisin-like cell-wall associated serine proteases, 43-49% homology	446	1	Rv3883c	MT3998	MTB12Ka	MB727.0K	No sequence data	
		550	2	Rv3886c	MT4001 (Frame)	MTB12Kb	MB727.2K	No sequence data	
		461	3	Rv0291	MT0304	MTB203K	MB548K	No sequence data	
		455	4	Rv3449	MT3555	MTB45K	MB585.1K	No sequence data	
		585	5	Rv1796	MT1845	MTB196K	MB506K	No sequence data	
L	2x amino-terminal transmembrane protein, 16-27% homology	462	1	Rv3882c	MT3997	MTB12La	MB727.0L	No sequence data	
		537	2	Rv3885c	MT4000 (Frame)	MTB12Lb	MB727.2L	No sequence data	
		331	3	Rv0292	MT0305	MTB203L	MB694.0L	No sequence data	
		-	4	No duplication	No duplication	No duplication	No duplication	No duplication	
		406	5	Rv1797	MT1846	MTB196L	MB542L	No sequence data	
Presence and names of genes in each species									
Gene family	Description	Protein size (in <i>M.tb</i>)	ESAT-6 cluster region	<i>M. leprae</i> TN	<i>M. avium</i> * 104	<i>M. paratuberculosis</i> * K 10	<i>M. smegmatis</i> * MC ² 155	<i>C. diphtheriae</i> * NCTC13129	<i>S. coelicolor</i> A3 (2)
A	ABC transporter family signature, 19-27% homology	283	1	ML0057(pseudo)	ND	ND	MS29A	ND	ND
		276	2	MLabc (pseudo)‡	MA138A	MP3889c	ND	ND	ND
		295	3	ML2530	MA141A	MP0289	MS32A	ND	ND
		-	4	No duplication	No duplication	No duplication	No duplication	No duplication	No duplication
		300	5	ML1540	MA310A	MP1794	ND	ND	ND
B	AAA+ class ATPases, CBXX/CFQX family, SpoVK, 1x ATP/GTP binding site, 29-39% homology	573	1	ML0055	ND	ND	MS29B	ND	ND
		619	2	ML0039(pseudo)	MA177B	MP3884c	ND	ND	ND
		631	3	ML2537	MA78B	MP0282	MS32B	ND	ND
		-	4	No duplication	No duplication	No duplication	No duplication	No duplication	No duplication
		610	5	ML1536	MA310B	MP1798	ND	ND	ND

comment

reviews

reports

deposited research

referenced research

interactions

information

Table 2 (continued)

Gene family	Description	Protein size (in <i>M.tb</i>)	ESAT-6 cluster region	Presence and names of genes in each species					
				<i>M. leprae</i> TN	<i>M. avium</i> *	<i>M. paratuberculosis</i> *	<i>M. smegmatis</i> *	<i>C. diphtheriae</i> *	<i>S. coelicolor</i>
C	Amino-terminal transmembrane protein, possible ATP/GTP-binding motif, 31-41% homology	480	1	ML0054	ND	ND	MS29C	ND	ND
		495	2	Deleted	MA144C	MP3895c	ND	ND	ND
		538	3	ML2536	MA78C	MP0283	MS32C	ND	ND
		470	4	Deleted	MA94C	MP3450c	MS8C	CORDmem	SC3C3.07
		506	5	ML1544	MA221C	MPI782	ND	ND	ND
D	DNA segregation ATPase, ftsK chromosome partitioning protein, SpoIIIE, yukA, 3x ATP/GTP-binding sites, 2 x amino-terminal transmembrane protein, 28-39% homology	747+591	1	ML0053+52	ND	ND	MS29D (Stop\$)	ND	ND
		1396	2	Deleted	MA144D	MP3894c	ND	ND	ND
		1330	3	ML2535	MA78D	MP0284	MS32D	ND	ND
		1236	4	Deleted	MA504D	MP3447c	MS8D	CORDyuk	SC3C3.20c
		435+932	5	ML1543	MA221D	MPI783	ND	ND	ND
E	PE, 18-90% homology	99	1	Deleted	ND	ND	MS29E	ND	ND
		77	2	Deleted	MA138E	MP3893c	ND	ND	ND
		102	3	ML2534	MA78E	MP0285	MS32E	ND	ND
		-	4	No	No	No	No	No	No
		99 & 99	5	duplication Deleted	duplication MA310Ea & Eb	duplication MPI788 & 91	duplication ND	duplication ND	duplication ND
F	PPE, 19-88% homology	368	1	ML0051	ND	ND	MS29F	ND	ND
		399	2	Deleted	MA138F	MP3892c	ND	ND	ND
		513	3	ML2533 (pseudo)	MA78F	MP0286	MS32F	ND	ND
		-	4	No	No	No	No	No	No
		365, 393 & 350	5	duplication Deleted	duplication MA310Fa & Fb & Fc	duplication MPI787 & 89 & 90	duplication ND	duplication ND	duplication ND
G	lhp or CFP-10, also MTSA-10, grouped into ESAT-6 family, potent secreted T-cell antigens, 9-32% homology	100	1	ML0050	ND	ND	MS29G	ND	SC3C3.10 and SC3C3.11 ^(c)
		107	2	Deleted	MA138G	MP3891c §	ND	ND	ND
		97	3	ML2532	MA141G	MP0287	MS32G	ND	ND
		125	4	Deleted	MA319G	MP3445c	MS8G	CORDcfp10	ND
		98	5	MLcfp (pseudo)‡	MA310G	MPI792	ND	ND	ND
H	ESAT-6 family, cfp7, L45 or l-esat, also Mtb9.9 family, potent secreted T-cell antigens, 15-27% homology	95	1	ML0049	ND	ND	MS29H	ND	SC3C3.10 and SC3C3.11 ^(f)
		95	2	ML0034 (pseudo)	MA138H	MP3890c §	ND	ND	ND
		96	3	ML2531	MA141H	MP0288	MS32H	ND	ND
		100	4	ML0363	MA319H	MP3444c	MS8H	CORDesat6	ND
		94	5	MLesat (pseudo)‡	MA310H	MPI793	ND	ND	ND
I	ATPases involved in chromosome	666	1	ML0048	ND	ND	MS29I	ND	SC3C3.03c
		341	2	ML0035 (pseudo)	MA138I	MP3888c	ND	ND	ND

Table 2 (continued)

Gene family	Description	Protein size (in <i>M.tb</i>)	ESAT-6 cluster region	Presence and names of genes in each species					
				<i>M. leprae</i>	<i>M. avium</i> *	<i>M. paratuberculosis</i> *	<i>M. smegmatis</i> *	<i>C. diphtheriae</i> *	<i>S. coelicolor</i>
				TN	I04	K I0	MC ² 155	NCTC13129	A3 (2)
	partitioning, 1x ATP/GTP-binding motif, 33% homology	-	3	No duplication	No duplication	No duplication	No duplication	No duplication	No duplication
		-	4	No duplication	No duplication	No duplication	No duplication	No duplication	No duplication
		-	5	No duplication	No duplication	No duplication	No duplication	No duplication	No duplication
J	Integral inner membrane protein, binding-protein-dependent transport systems inner membrane component signature, putative transporter protein, 19-27% homology	511 509 472 467 503	1 2 3 4 5	ML0047 ML0036 (pseudo) ML2529 Deleted ML1539	ND MA138J MA141J MA504J MA310J	ND MP3887c MP0290 MP3448 MP1795	MS29J ND MS32J MS8J ND	ND ND ND CORDtransporter ND	ND ND ND SC3C3.21 ND
K	Mycosins, subtilisin-like cell-wall associated serine proteases, 43-49% homology	446 550 461 455 585	1 2 3 4 5	ML0041 ML0037 (pseudo) ML2528 Deleted ML1538	ND MA177K MA141K MA439K MA310K	ND MP3886c MP0291 MP3449 MP1796	MS65K ND MS32K MS8K ND	ND ND ND CORDsub ND	ND ND ND SC3C3.17c and SC3C3.08 ND
L	2x amino-terminal transmembrane protein, 16-27% homology	462 537 331 - 406	1 2 3 4 5	ML0042 ML0038 (pseudo) ML2527 No duplication ML1537	ND MA177L MA81L No duplication MA310L	ND MP3885c MP0292 No duplication MP1797	MS65L ND MS32L No duplication ND	ND ND ND No duplication ND	ND ND ND No duplication ND

Other region-specific genes of known functions (not assigned to a family)

Region 5 (not present in *M. smegmatis*, *C. diphtheriae* and *S. coelicolor*)
 Rv1785c Probable member of the cytochrome P450 family (pseudogene in *M. leprae*)
 Rv1786 Probable ferredoxin (pseudogene in *M. leprae*)

Other region-specific genes of unknown functions (not assigned to a family)

Region 1 (deleted in *M. avium* and *M. paratuberculosis*, not present in *C. diphtheriae* and *S. coelicolor*)
 Rv3867 Unknown, annotated as part of MT3980 (Rv3866) in *M. tuberculosis* CDC1551 sequence with a frameshift (functional in *M. leprae*)
 Rv3878 Unknown, some similarity to PPE family, deleted with RDI deletion region in *M. bovis* BCG (pseudogene in *M. leprae*)
 Rv3879c Unknown, repetitive, highly proline-rich N-terminus, deleted with RDI deletion region in *M. bovis* BCG (pseudogene in *M. leprae*)
 Rv3880c Unknown (functional in *M. leprae*)
 Rv3881c Unknown (pseudogene in *M. leprae*)

Region 4 (not present in *S. coelicolor*)
 Rv3446c Unknown, may contain a possible ABC transporter signature (deleted in *M. leprae*)

*Names of genes of these organisms were given arbitrarily by the authors of this paper. †Gene not identified by BLAST, data obtained from [1], GenBank accession no. U34848 and AAC44033. ‡The gene is present in the sequence, but not annotated (name given arbitrarily by authors of this paper). §Genes identified by BLAST as well as data obtained from GenBank, accession no. AJ250015. ¶Orthologs in *S. coelicolor* are equally similar to family G and H. ND, Not detected - not necessarily absent from genome but possibly not detected because of unfinished sequencing process. No duplication, no duplication of this gene is present in this region. No sequence data, no sequence data is available for this organism, published deletion information is included ([1] and others). Deleted, deleted from the genome of this particular species or strain (# = deleted in only some strains of this species). Frame, frameshift. Stop, in-frame stop codon. Stop\$, stop codon corresponds to stop codon in *M. tuberculosis* H37Rv, which splits gene into Rv3870 and Rv3871. Pseudo, confirmed pseudogene due to multiple frameshifts and stop codons.

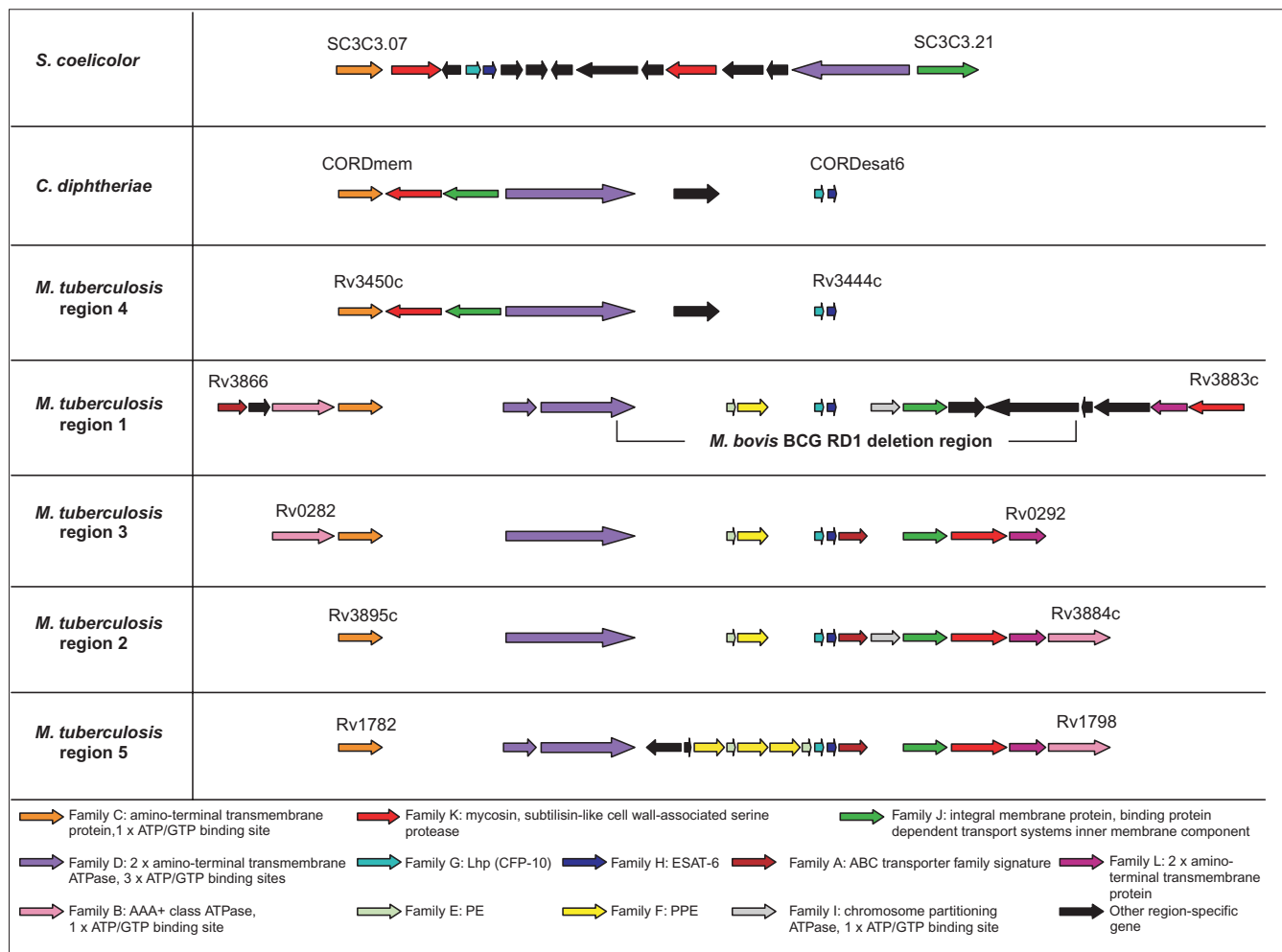
**Figure 1**

Schematic representation of the genomic organization of the genes present in the five ESAT-6 gene cluster regions of *Mycobacterium tuberculosis* H37Rv as well as the regions in *C. diphtheriae* and *S. coelicolor*. ORFs are represented as blocked arrows showing the direction of transcription, with the different colors reflecting the specific gene family and the length of the arrow reflecting the relative lengths of the genes. Annotations of *M. tuberculosis* H37Rv genes are according to Cole *et al.* [13]. Black arrows indicate unconserved genes present in these regions. Gaps between genes do not represent physical gaps between genes on the genome, but have been inserted to aid in indicating conservation among gene positions. Gene families were named arbitrarily according to their position in *M. tuberculosis* H37Rv region 1. The regions were named after the numbering system of Brown *et al.* [19] used arbitrarily for the five mycosin (subtilisin-like serine protease) genes identified from these regions (family K). *M. tuberculosis* regions are shown in order of suggested duplication events (see phylogenetic results) and not by numbering. The results of the analyses of the primary features of these genes and their corresponding proteins are included in a short summary at the bottom of the figure (see also Table 2).

become pseudogenes as a result of extensive point mutations. This is in contrast to the genes from region 1 (which lies directly adjacent to region 2), which contains no pseudogenes. It is thus conceivable that these clusters should function as a unit, and that genes could become non-functional when part of the unit is disrupted. Furthermore, all the genes immediately flanking the putative functional regions, as well as five of the eight genes only present in one of the regions as depicted in Table 2 (the Rv1785c, Rv1786, Rv3878, Rv3879c and Rv3881c orthologs ML1542, ML1541, MLO046, MLO045 and MLO043), are probable pseudogenes, indicating that the

genes present in the functional clusters are being maintained as a unit.

M. avium and *M. paratuberculosis*

The genomes of the *M. avium* strain 104 and the closely related species *M. paratuberculosis* (or *M. avium* subsp. *paratuberculosis*) has revealed four of the five ESAT-6 gene cluster regions (sharing between 65 and 75% similarity to *M. tuberculosis* H37Rv at protein level), with region 1 being absent in both species (Figure 4). Closer inspection of the gene sequence surrounding region 1 in both these species

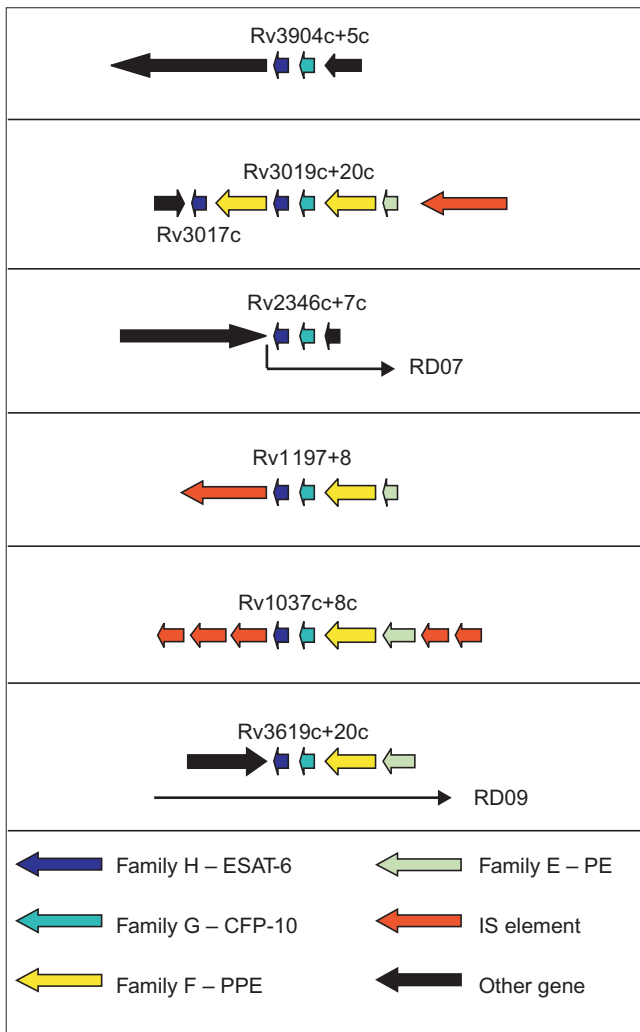

Figure 2
Schematic representation of the six additional *esat-6/lhp* operon duplications and the regions that surround them in the genome of *M. tuberculosis* H37Rv. ORFs are represented by blocked arrows indicating direction of transcription, with the different colors reflecting the specific gene family and the length of the arrow reflecting the relative lengths of the genes as in Figure 1. The *esat-6* and *lhp* genes deleted in *M. bovis* RD07 and RD09 deletion regions [7] are indicated.

has revealed a deletion of the region containing region 1 and some upstream flanking genes (from the Rv3861 gene ortholog up to and including the Rv3883c ortholog). This deletion coincided with the insertion of a $\pm 2,292$ bp sequence containing the genes for a putative hydroxylase (± 818 bp) and the sigI sigma factor (± 824 bp). The presence of this sequence in both genomes (99% DNA sequence identity) indicates that the insertion/deletion may have occurred before the divergence of the two species. The genes from the remaining ESAT-6 gene cluster regions that are present in *M. avium* and *M. paratuberculosis* contain no stop codons or frameshifts and thus appear to be functional.

M. smegmatis

The genome sequence of the avirulent, fast-growing mycobacterial species *M. smegmatis* contains three of the five ESAT-6 gene cluster regions, namely regions 1, 3 and 4 (sharing between 60 and 75% similarity to *M. tuberculosis* H37Rv at protein level), with regions 2 and 5 being absent (Figure 5). No deletions, frameshifts or stop codons were identified in any of the genes present in the regions 1, 3 and 4 and therefore it is concluded that these regions are functional.

ESAT-6 gene cluster identification in bacteria other than the mycobacteria

Corynebacterium diphtheriae

The genome sequence of the closely related *C. diphtheriae* has revealed a copy of the region 4 ESAT-6 gene cluster (Figure 1, see Table 3 for percentage similarity between sequences), situated in the same genomic location as in the mycobacteria (indicated by the large stretch of flanking genes homologous to the genes flanking region 4 in *M. tuberculosis* H37Rv). All the genes present within this cluster appear to be fully functional, as no deletions, stop codons or frameshifts were identified. No duplications of the gene cluster could be detected in the genome of this organism.

Streptomyces coelicolor

The *S. coelicolor* genome has revealed distinct orthologs for four of the six most conserved genes from the ESAT-6 gene cluster regions located in close proximity to each other (Figure 1). These genes show the highest similarity to the corresponding orthologs in region 4 of *M. tuberculosis* (see Table 3 for percentage similarity between sequences). There is also a very distinct ortholog (SC3C3.03c) of the region 1 family I gene (Rv3876) in the *S. coelicolor* region. There is no homolog for this gene in region 4 of *M. tuberculosis*. A sequence-similarity search using the sequences of the other two proteins encoded in region 4, namely ESAT-6 (Rv3444c) and CFP-10 (Rv3445c), has also revealed some similarity to two small genes situated within the same region in the genome of *S. coelicolor* (Table 3, Figure 1). These genes (SC3C3.10 and SC3C3.11) encode small proteins (124 and 103 amino acids) of unknown function, are very similar to each other, and lie adjacent to each other, similar to the observation for the *esat-6/lhp* operon. The sequences of both these proteins also contain the motif W-X-G, a feature present in most of the ESAT-6 and CFP-10 proteins. The higher degree of similarity between the genes from region 4 of the mycobacteria (and *C. diphtheriae*) and those present in the region in *S. coelicolor* suggests that region 4 may be the ancestral region in the mycobacteria, although a number of differences between these regions do exist.

Taxonomy

It is evident from the taxonomy (Figure 6) of the different species of bacteria in which copies of the ESAT-6 gene clusters could be found, that the presence of these clusters appears to be a specific characteristic of the high G+C

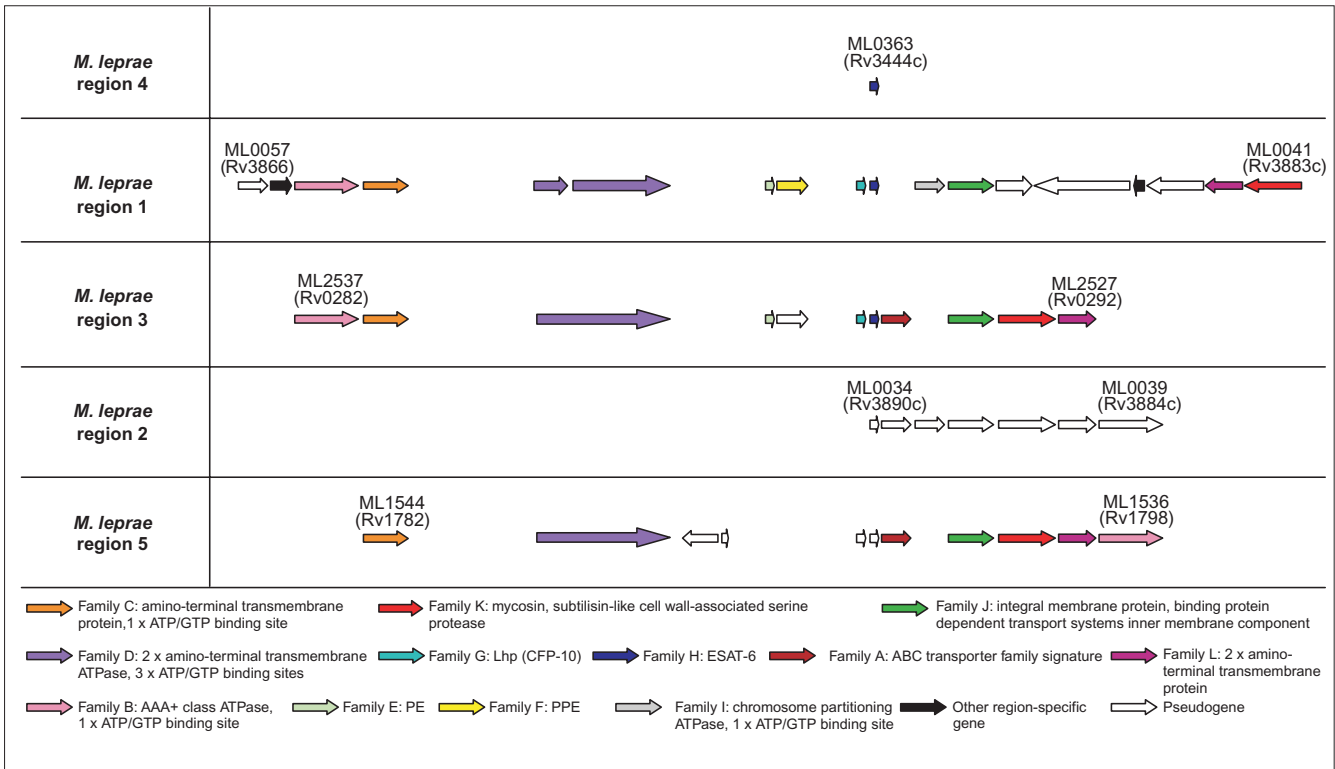

Figure 3
Schematic representation of the genomic organization of the genes present in the five ESAT-6 gene cluster regions of *Mycobacterium leprae*. ORF's are represented as blocked arrows showing the direction of transcription, with the different colors reflecting the specific gene family and the length of the arrow reflecting the relative lengths of the genes as in Figure 1. Black arrows indicate unconserved genes present in these regions, while open arrows indicate pseudogenes. Annotations of *M. leprae* genes are according to Cole *et al.* [25].

Gram-positive Actinobacteria, and that multiple copies thereof are only found in the mycobacteria. No copies of the clusters could be found in the completed genome sequence of *Bacillus subtilis* and that of other related species, which also form part of the Firmicutes (Gram-positive bacteria), but fall under the *Bacillus/Clostridium* group (low G+C Gram-positive bacteria). No copies of these clusters could be found in the genomes of any other bacteria or organism outside of the Firmicutes and thus the ESAT-6 gene clusters appear to be unique to the Actinobacteria.

Phylogeny of the ESAT-6 gene cluster

To calculate the phylogenetic relationships between the five duplicated ESAT-6 gene cluster regions in *M. tuberculosis* and to identify the ancestral region, detailed phylogenetic analyses were performed on each of the six protein families present in all five of these regions (families C, D, G, H, J and K). Figure 7a shows a neighbor-joining tree of the protein sequences of the ATP/GTP-binding protein family (family D) from the ESAT-6 gene clusters of mycobacteria and *C. diphtheriae*, with the protein ortholog from *S. coelicolor* as the outgroup. This tree is representative of all six trees that were drawn using the six families (data for the other

trees are not shown). To confirm the results obtained with the *S. coelicolor* orthologs as outgroups, the same analyses were done using the *C. diphtheriae* orthologs as outgroups, with comparable results (data not shown). This tree topology was not due to systematic error, as trees drawn using the FITCH algorithm gave the same results (data not shown). To confirm the basic structure of the trees and to verify that this structure is not influenced by the choice of outgroup, unrooted trees without any outgroup were constructed using the KITSCH algorithm, once again with comparable results (data not shown). To further verify the relationships among these clusters, the conserved sequences of all six proteins from *M. tuberculosis* were combined into one protein sequence and the same analysis performed (Figure 7b).

To investigate whether the non-conserved protein families (those that are not present in region 4 of the mycobacteria, *C. diphtheriae* or *S. coelicolor*) show the same basic phylogenetic relationships as the conserved families (present in all five regions), an analysis was done on the AAA+ class ATPase family (family B). This family does not have a homolog in region 4 and there is also no *C. diphtheriae* or *S. coelicolor* ortholog to use as outgroup. The tree constructed from the

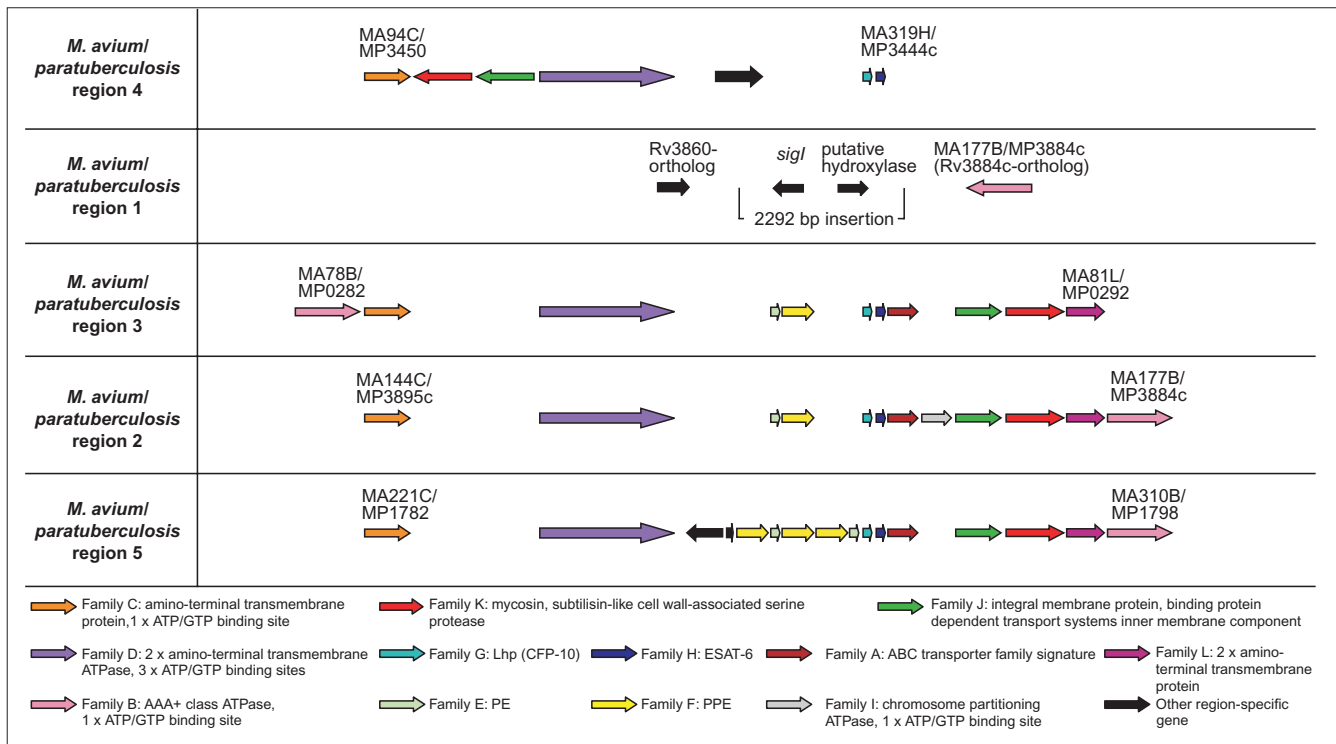

data from this family clearly showed once again that regions 2 and 5, and region 1 and 3, respectively, are phylogenetically closer to each other (data not shown).

Neighbor joining, FITCH, KITSCH and concatenated sequence comparison analyses all supported a single phylogeny that indicated that region 4 seems to be the most ancient of the mycobacterial ESAT-6 gene cluster regions. Region 4 is also the closest region to the *S. coelicolor* and *C. diphtheriae* regions. The order of duplication seems to extend from region 4, through 1 and 3 to regions 2 and 5. The phylogenetic relationships between corresponding clusters in the different mycobacteria are maintained throughout the different protein-family trees, and agree with the proposed phylogenetic order (or taxonomic position) of the mycobacterial species according to 16S rRNA data (see Figure 6).

As the genome of *M. tuberculosis* contains 11 copies of the *esat-6/lhp* gene pair that appears to be duplicated together, phylogenetic trees were constructed using the ESAT-6 or CFP-10 proteins separately (data not shown), or in combination as one ESAT-6/CFP-10 protein (Figure 7c). Using the

combined *C. diphtheriae* ESAT-6/CFP-10 ortholog protein as outgroup, the same organization of duplication events was obtained with regions 1, 3, 2 and lastly 5 being duplicated from the ancient region 4. The other copies of the *esat-6/lhp* operon pair that are present in the *M. tuberculosis* genome sequence, but are not part of the ESAT-6 gene cluster regions, seem to have arisen from singular duplication events originating from different cluster regions. It is interesting to note that *esat-6* and *lhp* from region 5 seem to be highly prone to duplication, as there are four additional copies of these two genes present in the genome, compared to just one additional copy originating from region 4 and region 3, respectively. These four gene duplicates of *esat-6* and *lhp* from region 5 are also nearly identical (93-100% similarity at protein level), indicating their recent duplication.

Discussion

It was recently estimated in an *in silico* analysis of the genome sequence of *M. tuberculosis* H37Rv, that 52% of the proteome has been derived from gene duplication events [18]. One such involves the formation of multiple copies of the genes for the secreted T-cell antigens ESAT-6 and

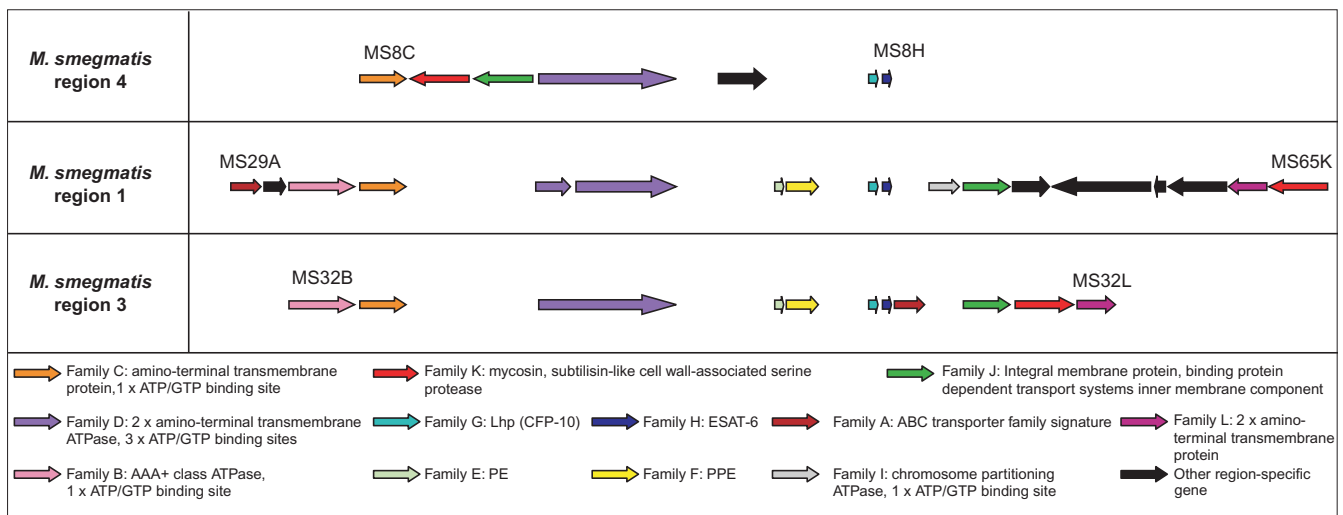
**Figure 5**

Schematic representation of the genomic organization of the genes present in the three ESAT-6 gene cluster regions of *Mycobacterium smegmatis*. ORFs are represented as blocked arrows showing the direction of transcription, with the different colors reflecting the specific gene family and the length of the arrow reflecting the relative lengths of the genes as in Figure 1. Black arrows indicate unconversed genes present in these regions. *M. smegmatis* genes were arbitrarily annotated by the authors of this paper.

CFP-10 [14,16,17] together with a number of associated genes. A total of twelve gene families were identified in five regions (which were termed the ESAT-6 loci).

Phylogenetic analyses of the protein sequences of the six most conserved gene families, present within the five regions, predict that region 4 (Rv3444c to Rv3450c) is the ancestral region. Region 4 also contains the least number of proteins (only 6 compared to the 12 of region 1 (Rv3866-3883c) and region 2 (Rv3884c-3895c)), and does not contain the genes for PE and PPE, which may have been inserted into this region after the first duplication. Phylogenetic analyses using different methods and protein family data also suggests that subsequent duplications took place in

the following order: region 1 (Rv3866-3883c) → 3 (Rv0282-0292) → 2 (Rv3884c-3895c) → 5 (Rv1782-1798). Furthermore, these analyses support the taxonomic order observed for the mycobacteria, with *M. smegmatis* being taxonomically the farthest removed from *M. tuberculosis*. The presence of a copy of region 4 and its flanking genes in *C. diphtheriae* strengthens the taxonomic data that implies that the corynebacteria and mycobacteria have a common ancestor. It appears that *C. diphtheriae* diverged from the mycobacteria before the multiple duplications of the ESAT-6 gene cluster, as only one copy of this cluster could be identified in the genome of this organism.

The loss of region 1 from the genomes of the species *M. avium* and *M. paratuberculosis* (belonging to the *M. avium* complex) is confirmed by clinical data showing that patients seronegative for the human immunodeficiency virus (HIV) and infected with mycobacteria belonging to the *M. avium* complex do not respond to ESAT-6 from region 1, but do recognize purified protein derivative (PPD) and *M. avium* sensitins [22]. The genes for ESAT-6 and CFP-10 (*esat-6* and *lhp*) in region 1 are also not found in *M. bovis* BCG and have thus been the focus of recent research because of their application as diagnostic markers to differentiate between BCG vaccination and *M. tuberculosis*, *M. bovis* or *M. avium* infection (see for example [17,23]). In this study we have found several copies of the ESAT-6 and CFP-10 genes (with differing degrees of similarity) in the genomes of different mycobacteria (80% and 71% protein sequence similarity for ESAT-6 and CFP-10 respectively from region 1 in avirulent *M. smegmatis*), as well as orthologs in species

Table 3

Similarity of *M. tuberculosis* H37Rv region 4-encoded proteins to proteins encoded by the *C. diphtheriae* and *S. coelicolor* regions

<i>M. tuberculosis</i> region 4 proteins	Family	Percentage similarity	
		<i>C. diphtheriae</i>	<i>S. coelicolor</i>
Rv3450c	C	47%	36%
Rv3447c	D	53%	57%
Rv3445c	G	47%	47 and 51%*
Rv3444c	H	58%	41 and 44%*
Rv3448	J	33%	45%
Rv3449	K	49%	45 and 47%

* Orthologs in *S. coelicolor* are equally similar to families G and H.

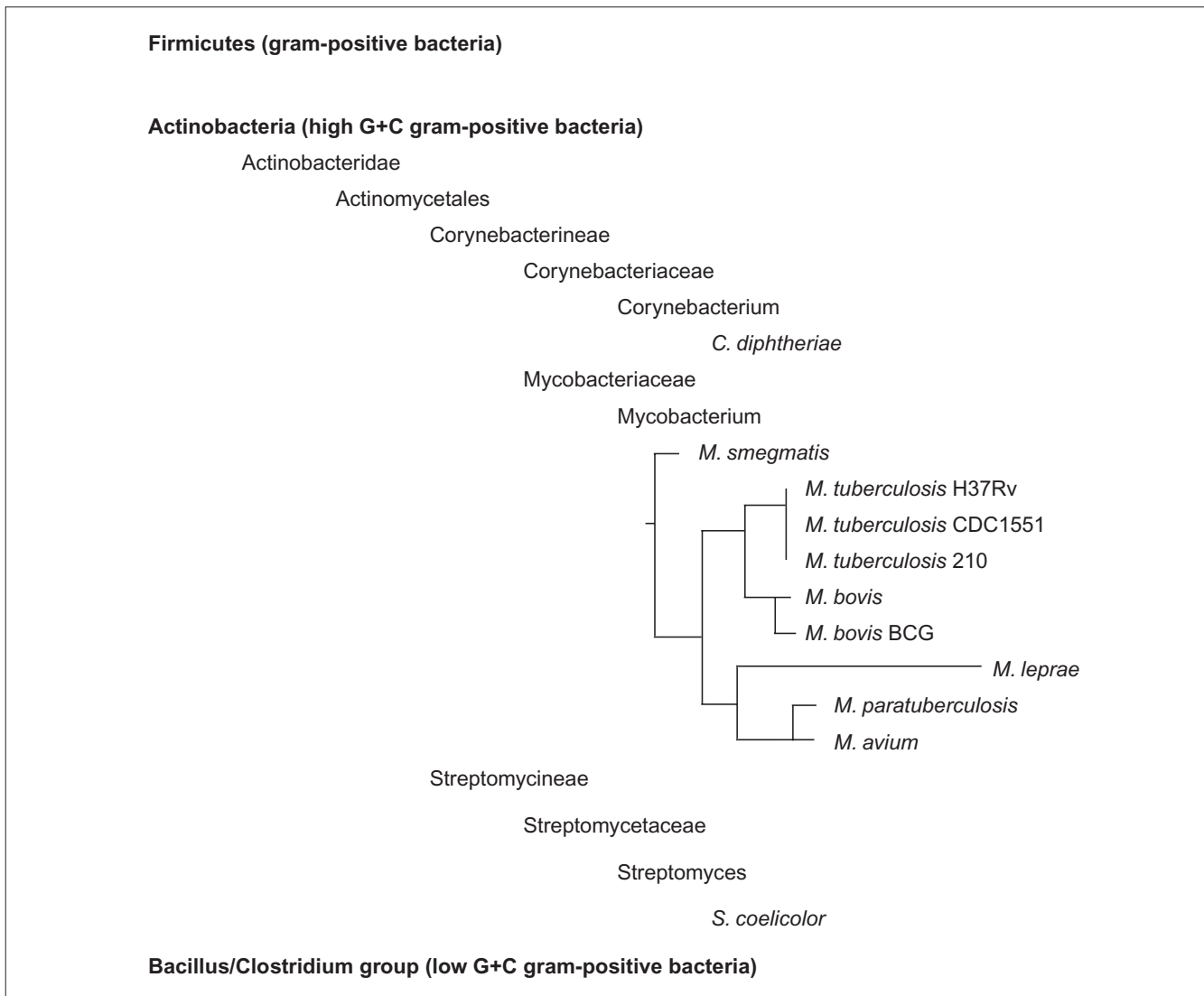

Figure 6

Taxonomic position of the bacterial species that have the ESAT-6 gene clusters present in their genomes. This indicates that the ESAT-6 gene clusters seem to be a feature of only the high G+C Gram-positive bacteria (Actinobacteria) and that the presence of multiple copies of the gene clusters seems to be a characteristic only found in the mycobacteria. Phylogenetic relationships of members of the genus *Mycobacterium* indicated are based on 16S rRNA gene sequence information [56].

outside the mycobacteria; care should therefore be taken when using these proteins for diagnostic purposes. It will be important to look at the protein sequence similarity between the copies of ESAT-6 and CFP-10 of different virulent and environmental mycobacterial species before a member of these immunodominant protein families can be chosen as a definite marker of *M. tuberculosis* infection. Studies to determine the production of interferon- γ in response to exposure to ESAT-6 and CFP-10 from environmental mycobacteria (for example *M. smegmatis*) by peripheral blood mononuclear cells from infected patients have not been done. Until these results are available, indicating that the T-cell responses against these proteins are not comparable to

those against the *M. tuberculosis* proteins, care should be taken with claims regarding the potential diagnostic value of these antigens.

Most of the sequences of the genes belonging to the ESAT-6 gene cluster regions contain no stop codons or frameshifts and thus appear to be functional. This is significant when placed in the context of a bacterium such as *M. leprae*, as it is hypothesized that the genome of *M. leprae* may contain the minimal gene set required by a pathogenic mycobacterium [5,24,25] and that the activities of some functional genes once present in the genome of *M. leprae* have been silenced (they became pseudogenes through multiple stop

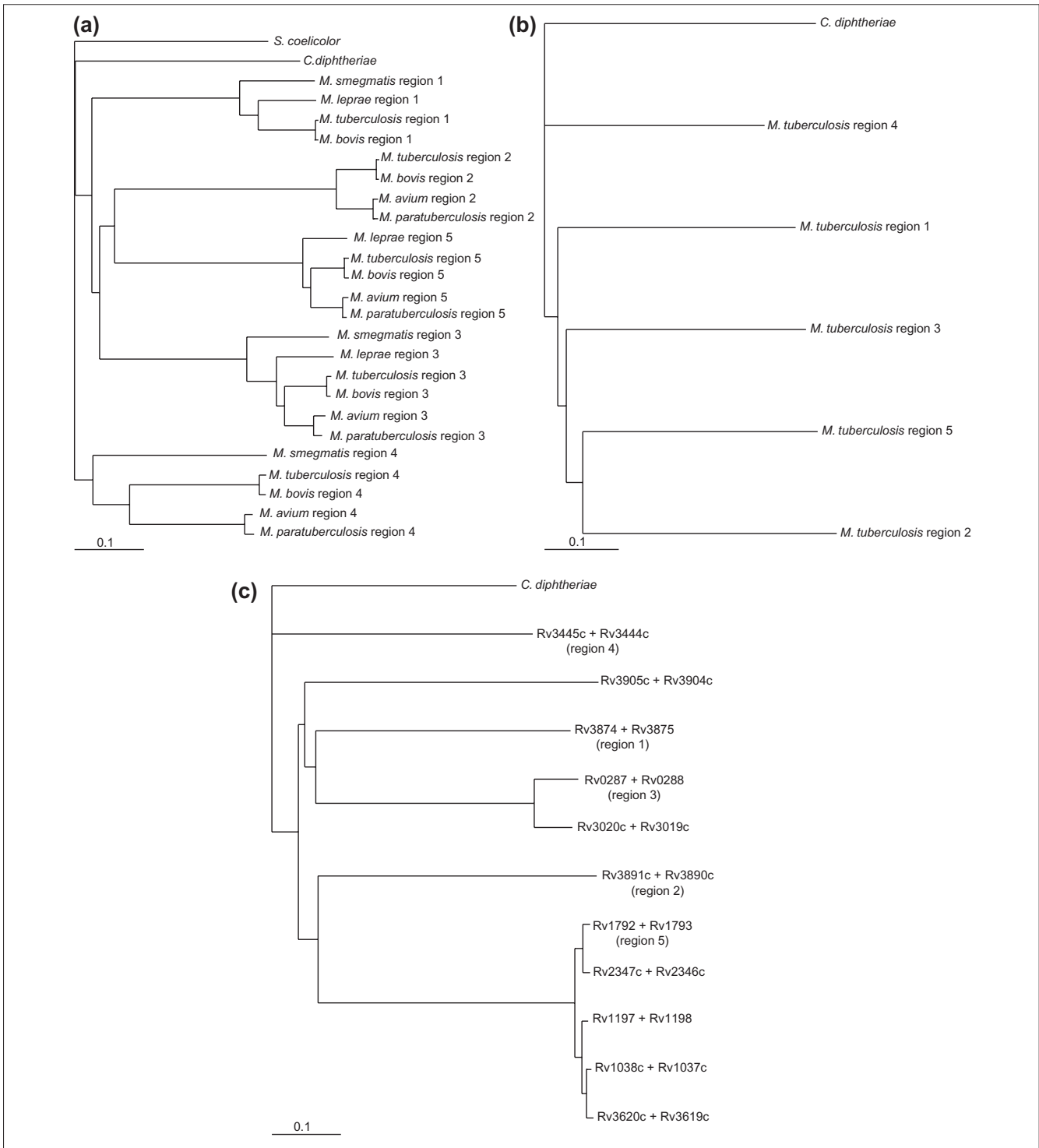

Figure 7
 Phylogenetic trees showing the relationships between the five duplicated gene cluster regions. **(a)** Neighbor-joining phylogenetic tree of all available protein sequences of the ATP/GTP-binding protein family (family D in Table 2) with the protein ortholog of *Streptomyces coelicolor* as the outgroup. This tree is representative of all the trees drawn using the six most conserved proteins in these regions as well as using the protein ortholog of *Corynebacterium diphtheriae* as the outgroup. **(b)** Neighbor-joining phylogenetic tree of all six conserved proteins from the *M. tuberculosis* gene clusters combined into one protein per region. The combined protein of *C. diphtheriae* was used as the outgroup. **(c)** Neighbor-joining phylogenetic tree of the ESAT-6 and CFP-10 protein families combined (family G and H), using the combined protein of *C. diphtheriae* as the outgroup.

codon mutations and frameshifts) because they are no longer needed for the bacterium's intracellular survival [13]. It appears that *M. leprae* contains at least two functional copies of the ESAT-6 gene cluster in its genome (regions 1 and 3). The *M. leprae* ESAT-6 copy from region 1 (the L45-antigen or L-ESAT antigen from clone L45) was shown to be strongly reactive to sera from leprosy patients [26], providing experimental evidence that at least one of the cluster regions is functional in *M. leprae*.

As most of the genes present within the ESAT-6 gene cluster regions encode proteins that are predicted to be associated with transport and energy-providing systems, we hypothesize that these proteins may be involved in the secretion of a substrate across the mycobacterial cell wall. It is well known that the T-cell antigens ESAT-6 and CFP-10 are found in short-term culture filtrates (ST-CF) of *M. tuberculosis*, although the mechanism of secretion is unknown, as these proteins do not possess any of the usual Sec-dependent secretion signals [14-16]. It is therefore possible that the genes in the ESAT-6 gene cluster regions act together to provide a system for the secretion of ESAT-6 and CFP-10. There is evidence for the processing of the TB10.4 protein (the ESAT-6 family member from region 3) to a lower molecular weight product [27], suggesting a possible role for the cell-wall-associated mycosin proteases [19] in the suggested transport system. Most of region 1 is situated in the RD1 deletion region of *M. bovis* BCG, possibly explaining the absence of expression of the mycosin-1 gene (Rv3883c) in BCG [19].

The hypothesis that an interdependent functional relationship exists between the proteins encoded in these regions is further supported by the *M. leprae* sequence data, which shows that deletions of parts of the ESAT-6 gene cluster region 2 apparently caused the remaining genes in the region to become pseudogenes. Furthermore, Wards and co-workers [12] produced an *M. bovis* knockout mutant of the ATPase gene Rv3871 (family D) in the ESAT-6 gene cluster region 1, resulting in a strain that did not sensitize guinea pigs to an ESAT-6 skin test. These results indicate a close relationship between the genes contained within these regions.

Wards *et al.* [12] showed that an *esat-6/lfp* knockout mutant of *M. bovis* was less virulent than its parent if gross pathology, histopathology and mycobacterial culture from tissues were taken into account. These results, combined with the fact that multiple copies of the ESAT-6 gene clusters are found in all the mycobacteria, clearly indicate that they form an important part of the mycobacterial genome. The presence of multiple duplications of the ESAT-6 gene cluster regions in the mycobacteria may be a significant difference between the members of this genus and other high G+C Gram-positives. Although the function of this cluster is presently unknown, there is sufficient evidence to indicate that it is of crucial importance to the mycobacteria and needs to be investigated further.

Materials and methods

Genome sequence data and analyses

Annotations and descriptions of individual genes as well as gene and protein sequences of individual organisms were obtained from the publicly available finished and unfinished genome sequence databases listed in Table 1. Preliminary sequence data for *M. tuberculosis* 210, *M. avium* 104 and *M. smegmatis* MC² 155 was obtained from The Institute for Genomic Research (TIGR) website [28]. Preliminary sequence data for *M. paratuberculosis* K10 was obtained from the University of Minnesota *M. paratuberculosis* website [29]. Preliminary sequence data for *M. bovis* AF2122/97 (spoligotype 9), *C. diphtheriae* NCTC13129 and *S. coelicolor* A3 (2), was obtained from the Sanger Centre website [30]. All gene and protein sequences were subjected to analysis with the following programs to confirm annotation and to look for additional information: SignalP V2.0.b2 [31,32], ClustalW WWW server at the European Bioinformatics Institute [33,34], TMHMM v0.1 [35,36], MOTIF [37] and BLASTP [38,39]. No data, progress report or BLAST search function is available for the genome sequencing of *M. bovis* BCG Pasteur 1173P2 at the Pasteur Institute, but information concerning genome deletions was obtained from published data [1-3,5-7] and from the Pasteur Institute website [40].

Analyses of similar gene clusters

BLAST similarity searches [38], using the BLAST 2.0 program with tblastn and the BLOSUM-62 weight matrix, were used to identify stretches of DNA containing putative ORFs homologous to the genes found in the *M. tuberculosis* ESAT-6 gene cluster regions from finished and unfinished genome sequences available at the National Center for Biotechnology Information (NCBI) website [41]. A total of 98 finished and unfinished genome sequences (35 from Gram-positive species) were used in the analysis, as summarized in Table 4. Where applicable, BLAST servers in database search services of individual sequencing centers were also used for protein identification. The Sanger Centre and The Institute for Genomic Research (TIGR) use the program WU-BLAST version 2.0 [42], while the University of Minnesota uses BLASTN with supplied defaults [43]. Sequences were only admitted to analysis when found to be part of one of the five gene clusters. In other words, no single homologous genes in the mycobacteria or other organisms (for example *B. subtilis*) that did not form part of a similar gene cluster were considered for the analyses, to exclude any potential unassociated similarity that could lead to false positives.

Contig sequences corresponding to the gene clusters were obtained from their respective genome databases and used in further analyses. The Genetics Computer Group (Wisconsin Package Version 10.0, Genetics Computer Group (GCG), Madison, Wisconsin) program FRAMESEARCH was used to obtain whole sequence ORFs from the contigs. These ORFs were translated to protein sequences with the program

Table 4**Publicly available finished and unfinished genome sequence databases used in this study**

<i>Acidithiobacillus ferrooxidans</i>	<i>Escherichia coli</i> O157:H7 EDL933	<i>Rhodobacter sphaeroides</i>
<i>Actinobacillus actinomycetemcomitans</i>	<u><i>Enterococcus faecalis</i></u>	<i>Salmonella dublin</i>
<i>Aquifex aeolicus</i>	<i>Geobacter sulfurreducens</i>	<i>Salmonella enteritidis</i>
<u><i>Bacillus anthracis</i></u>	<i>Haemophilus ducreyi</i> 35000HP	<i>Salmonella paratyphi</i>
<u><i>Bacillus halodurans</i></u>	<i>Haemophilus influenzae</i> Rd	<i>Salmonella typhi</i>
<u><i>Bacillus subtilis</i></u>	<i>Helicobacter pylori</i> 26695	<i>Salmonella typhimurium</i> LT2
<u><i>Bacillus stearothermophilus</i></u>	<i>Helicobacter pylori</i> J99	<i>Shewanella putrefaciens</i>
<i>Bordetella bronchiseptica</i>	<i>Klebsiella pneumoniae</i>	<i>Sinorhizobium meliloti</i>
<i>Bordetella parapertussis</i>	<u><i>Lactococcus lactis</i> subsp. <i>lactis</i></u>	<u><i>Staphylococcus aureus</i> COL</u>
<i>Bordetella pertussis</i>	<i>Legionella pneumophila</i>	<u><i>Staphylococcus aureus</i> MRSA</u>
<i>Borrelia burgdorferi</i>	<u><i>Listeria monocytogenes</i></u>	<u><i>Staphylococcus aureus</i> MSSA</u>
<i>Brucella melitensis</i> biovar <i>Suis</i>	<i>Mesorhizobium loti</i>	<u><i>Staphylococcus aureus</i> Mu50</u>
<i>Buchnera</i> sp. <i>APS</i>	<i>Methylococcus capsulatus</i>	<u><i>Staphylococcus aureus</i> N315</u>
<i>Burkholderia mallei</i>	<u><i>Mycobacterium avium</i></u>	<u><i>Staphylococcus aureus</i> NCTC 8325</u>
<i>Burkholderia pseudomallei</i>	<i>Mycobacterium avium</i> subsp. <i>paratuberculosis</i>	<u><i>Staphylococcus epidermidis</i></u>
<i>Campylobacter jejuni</i> NCTC 11168	<u><i>Mycobacterium bovis</i></u>	<u><i>Streptococcus equi</i></u>
<i>Carboxydotherrmus hydrogenoformans</i>	<u><i>Mycobacterium leprae</i></u>	<u><i>Streptococcus gordonii</i></u>
<i>Caulobacter crescentus</i>	<u><i>Mycobacterium smegmatis</i></u>	<u><i>Streptococcus mutans</i></u>
<i>Chlamydia muridarum</i>	<u><i>Mycobacterium tuberculosis</i> 210</u>	<u><i>Streptococcus pneumoniae</i></u>
<i>Chlamydia pneumoniae</i>	<u><i>Mycobacterium tuberculosis</i> CDC1551</u>	<u><i>Streptococcus pyogenes</i></u>
<i>Chlamydia trachomatis</i> D/UW-3/CX	<u><i>Mycobacterium tuberculosis</i> H37Rv</u>	<u><i>Streptococcus pyogenes</i> Manfredo</u>
<i>Chlamydomphila pneumoniae</i> AR39	<u><i>Mycoplasma genitalium</i> G37</u>	<u><i>Streptomyces coelicolor</i> A3(2)</u>
<i>Chlamydomphila psittaci</i>	<u><i>Mycoplasma pneumoniae</i> M129</u>	<i>Synechocystis</i> PCC6803
<i>Chlorobium tepidum</i>	<i>Neisseria gonorrhoeae</i>	<i>Thermotoga maritima</i>
<u><i>Clostridium acetobutylicum</i></u>	<i>Neisseria meningitidis</i> MC58	<i>Treponema denticola</i>
<u><i>Clostridium difficile</i></u>	<i>Neisseria meningitidis</i> Z2491	<i>Treponema pallidum</i>
<u><i>Corynebacterium diphtheriae</i></u>	<i>Pasteurella multocida</i> PM70	<u><i>Ureaplasma urealyticum</i></u>
<i>Coxiella burnetii</i>	<i>Porphyromonas gingivalis</i> VV83	<i>Vibrio cholerae</i>
<i>Dehalococcoides ethenogenes</i>	<i>Pseudomonas aeruginosa</i>	<i>Wolbachia</i>
<i>Desulfovibrio vulgaris</i>	<i>Pseudomonas putida</i> KT2440	<i>Xylella fastidiosa</i>
<i>Deinococcus radiodurans</i>	<i>Pseudomonas putida</i> PRS1	<i>Yersinia enterocolitica</i>
<i>Escherichia coli</i> K-12 MG1655	<i>Pseudomonas syringae</i> pv. <i>tomato</i>	<i>Yersinia pestis</i>
<i>Escherichia coli</i> O157:H7	<i>Rickettsia prowazekii</i>	

Finished genome sequences are indicated in bold, Gram-positive species are underlined.

TRANSLATE (also from GCG). All multiple sequence alignments and phylogenetic analyses were conducted on the protein level with these translated protein sequences.

Multiple sequence alignments

Multiple sequence alignments were performed on separate gene families belonging to the different clusters using ClustalW 1.5 [33] with the default parameters. The alignments were manually checked for errors and refined where appropriate. Multiple sequence alignments were also manually edited in some analyses during which unaligned regions (inserts) were removed (resulting in so-called edited alignments).

Phylogenetic trees

Bootstrapping resampling of the data sets were performed on the edited alignments, which generated 100 randomly chosen subsets of the multiple sequence alignment. Pairwise distances were determined with PROTDIST using the Dayhoff PAM matrix and neighbor-joining phylogenetic trees were calculated using NEIGHBOR (PHYLIP 3.5, [44]). In the case of each family of proteins, the *C. diphtheriae* sequence was first used as the outgroup after which the

S. coelicolor sequence was used. Further phylogenetic analyses were performed using the programs FITCH and KITSCH with and without the outgroups respectively. A majority rule and strict consensus tree of all bootstrapped sequences were obtained using CONSENSE. The same analyses as described above were performed on a combined protein consisting of the edited aligned sequences of all six conserved proteins in these gene clusters as well as a combined protein constructed from the edited aligned sequences of all available ESAT-6 and CFP-10 family members. Finally, to confirm the results obtained with the single proteins, an analysis was performed with whole, unedited aligned sequences of the six most conserved proteins, using the program Paup 4.0b4a [45], during which negative branches were collapsed and 1,000 subsets were generated for bootstrapping resampling of the data. The consensus trees of all the above were drawn using the program Treeview 1.5 [46].

Acknowledgements

We are indebted to Rob Warren for continued advice, support, and critical reading of the manuscript. Sequencing of *M. paratuberculosis* was accomplished with support from USDA and Minnesota Agricultural

Experiment Station; sequencing of *M. avium* I04 and *M. smegmatis* MC² 155 at TIGR with support from the NIAID, sequencing of *M. bovis* AF2122/97 (spoligotype 9) with support from MAFF/Beowulf Genomics, *C. diphtheriae* NCTC13129 with support from Beowulf Genomics and *S. coelicolor* A3(2) with support from BBSRC/Beowulf Genomics. This work is dedicated to the memory of Albert Beyers.

References

- Mahairas GG, Sabo PJ, Hickey MJ, Singh DC, Stover CK: **Molecular analysis of genetic differences between *Mycobacterium bovis* BCG and virulent *M. bovis*.** *J Bacteriol* 1996, **178**:1274-1282.
- Philipp WJ, Nair S, Guglielmi G, Lagranderie M, Gicquel B, Cole ST: **Physical mapping of *Mycobacterium bovis* BCG pasteur reveals differences from the genome map of *Mycobacterium tuberculosis* H37Rv and from *M. bovis*.** *Microbiology* 1996, **142**:3135-3145.
- Brosch R, Gordon SV, Billault A, Garnier T, Eiglmeier K, Soravito C, Barrell BG, Cole ST: **Use of a *Mycobacterium tuberculosis* H37Rv bacterial artificial chromosome library for genome mapping, sequencing, and comparative genomics.** *Infect Immun* 1998, **66**:2221-2229.
- Brosch R, Philipp WJ, Stavropoulos E, Colston MJ, Cole ST, Gordon SV: **Genomic analysis reveals variation between *Mycobacterium tuberculosis* H37Rv and the attenuated *M. tuberculosis* H37Ra strain.** *Infect Immun* 1999, **67**:5768-5774.
- Brosch R, Gordon SV, Buchrieser C, Pym AS, Garnier T, Cole ST: **Comparative genomics uncovers large tandem chromosomal duplications in *Mycobacterium bovis* BCG Pasteur.** *Yeast* 2000, **17**:111-123.
- Gordon SV, Brosch R, Billault A, Garnier T, Eiglmeier K, Cole ST: **Identification of variable regions in the genomes of tubercle bacilli using bacterial artificial chromosome arrays.** *Mol Microbiol* 1999, **32**:643-655.
- Behr MA, Wilson MA, Gill WP, Salamon H, Schoolnik GK, Rane S, Small PM: **Comparative genomics of BCG vaccines by whole-genome DNA microarray.** *Science* 1999, **284**:1520-1523.
- Zumarraga M, Bigi F, Alito A, Romano MI, Cataldi A: **A 12.7 kb fragment of the *Mycobacterium tuberculosis* genome is not present in *Mycobacterium bovis*.** *Microbiology* 1999, **14**:893-897.
- Ahmad S, Amoudy HA, Thole JE, Young DB, Mustafa AS: **Identification of a novel protein antigen encoded by a *Mycobacterium tuberculosis*-specific RD1 region gene.** *Scand J Immunol* 1999, **49**:515-522.
- Brandt L, Elhay M, Rosenkrands I, Lindblad EB, Andersen P: **ESAT-6 subunit vaccination against *Mycobacterium tuberculosis*.** *Infect Immun* 2000, **68**:791-795.
- Arend SM, Geluk A, van Meijgaarden KE, van Dissel JT, Theisen M, Andersen P, Ottenhoff TH: **Antigenic equivalence of human T-cell responses to *Mycobacterium tuberculosis*-specific RD1-encoded protein antigens ESAT-6 and culture filtrate protein 10 and to mixtures of synthetic peptides.** *Infect Immun* 2000, **68**:3314-3321.
- Wards BJ, de Lisle GW, Collins DM: **An *esat6* knockout mutant of *Mycobacterium bovis* produced by homologous recombination will contribute to the development of a live tuberculosis vaccine.** *Tuber Lung Dis* 2000, **80**:185-189.
- Cole ST, Brosch R, Parkhill J, Garnier T, Churcher C, Harris D, Gordon SV, Eiglmeier K, Gas S, Barry CE, III, et al.: **Deciphering the biology of *Mycobacterium tuberculosis* from the complete genome sequence.** *Nature* 1998, **393**:537-544.
- Andersen P, Andersen AB, Sørensen AL, Nagai S: **Recall of long-lived immunity to *Mycobacterium tuberculosis* infection in mice.** *J Immunol* 1995, **154**:3359-3372.
- Berthet FX, Rasmussen PB, Rosenkrands I, Andersen P, Gicquel B: **A *Mycobacterium tuberculosis* operon encoding ESAT-6 and a novel low-molecular-mass culture filtrate protein (CFP-10).** *Microbiology* 1998, **144**:3195-3203.
- Sørensen AL, Nagai S, Houen G, Andersen P, Andersen AB: **Purification and characterization of a low-molecular-mass T-cell antigen secreted by *Mycobacterium tuberculosis*.** *Infect Immun* 1995, **63**:1710-1717.
- Van Pinxteren LA, Ravn P, Agger EM, Pollock J, Andersen P: **Diagnosis of tuberculosis based on the two specific antigens ESAT-6 and CFP10.** *Clin Diagn Lab Immunol* 2000, **7**:155-160.
- Tekaia F, Gordon SV, Garnier T, Brosch R, Barrell BG, Cole ST: **Analysis of the proteome of *Mycobacterium tuberculosis* in silico.** *Tuber Lung Dis* 1999, **79**:329-342.
- Brown GD, Dave JA, Gey van Pittius NC, Stevens L, Ehlers MR, Beyers AD: **The mycosins of *Mycobacterium tuberculosis* H37Rv: a family of subtilisin-like serine proteases.** *Gene* 2000, **254**:147-155.
- Tuberculist [http://genolist.pasteur.fr/Tuberculist/]
- Rauzier J, Gormley E, Gutierrez MC, Kassa-Kelembho E, Sandall LJ, Dupont C, Gicquel B, Murray A: **A novel polymorphic genetic locus in members of the *Mycobacterium tuberculosis* complex.** *Microbiology* 1999, **145**:1695-1701.
- Lein AD, von Reyn CF, Ravn P, Horsburgh CR Jr, Alexander LN, Andersen P: **Cellular immune responses to ESAT-6 discriminate between patients with pulmonary disease due to *Mycobacterium avium* complex and those with pulmonary disease due to *Mycobacterium tuberculosis*.** *Clin Diagn Lab Immunol* 1999, **6**:606-609.
- Vordermeier HM, Cockle PJ, Whelan AO, Rhodes S, Hewinson RG: **Toward the development of diagnostic assays to discriminate between *Mycobacterium bovis* infection and Bacille Calmette-Guérin vaccination in cattle.** *Clin Infect Dis* 2000, **30** (Suppl 3):S291-S298.
- Wixon J: **Genomes 2000 International Conference on Microbial and Model Genomes.** *Yeast* 2000, **17**:124-133.
- Cole ST, Eiglmeier K, Parkhill J, James KD, Thomson NR, Wheeler PR, Honore N, Garnier T, Churcher C, Harris D, et al.: **Massive gene decay in the leprosy bacillus.** *Nature* 2001, **409**:1007-1011.
- Sathish M, Esser RE, Thole JE, Clark-Curtiss JE: **Identification and characterization of antigenic determinants of *Mycobacterium leprae* that react with antibodies in sera of leprosy patients.** *Infect Immun* 1990, **58**:1327-1336.
- Skjøt RL, Oettinger T, Rosenkrands I, Ravn P, Brock I, Jacobsen S, Andersen P: **Comparative evaluation of low-molecular-mass proteins from *Mycobacterium tuberculosis* identifies members of the ESAT-6 family as immunodominant T-cell antigens.** *Infect Immun* 2000, **68**:214-220.
- The Institute for Genomic Research [http://www.tigr.org]
- University of Minnesota *M. paratuberculosis* [http://www.cbc.umn.edu/ResearchProjects/AGAC/Mptb/Mptb-home.html]
- Sanger Centre [http://www.sanger.ac.uk/Projects/]
- Nielsen H, Engelbrecht J, Brunak S, von Heijne G: **Identification of prokaryotic and eukaryotic signal peptides and prediction of their cleavage sites.** *Protein Eng* 1997, **10**:1-6.
- SignalP V2.0.b2 [http://www.cbs.dtu.dk/services/SignalP-2.0/#submission]
- Thompson JD, Higgins DG, Gibson TJ: **CLUSTAL W: improving the sensitivity of progressive multiple sequence alignment through sequence weighting, position-specific gap penalties and weight matrix choice.** *Nucleic Acids Res* 1994, **22**:4673-4680.
- ClustalW WWW server at the European Bioinformatics Institute [http://www2.ebi.ac.uk/clustalw/]
- Sonnhammer EL, von Heijne G, Krogh A: **A hidden Markov model for predicting transmembrane helices in protein sequences.** *Proc Intl Conf Intell Syst Mol Biol* 1998, **6**:175-182.
- TMHMM v0.2 [http://www.cbs.dtu.dk/services/TMHMM-2.0/]
- MOTIF [http://www.motif.genome.ad.jp/]
- Altschul SF, Gish W, Miller W, Myers EV, Lipman DJ: **Basic local alignment search tool.** *J Mol Biol* 1990, **215**:403-410.
- BLASTP [http://www.ncbi.nlm.nih.gov/blast/blast.cgi?form=0]
- Pasteur Institute [http://www.pasteur.fr/recherche/unites/Lgmb/Deletion.html]
- NCBI BLAST Server [http://www.ncbi.nlm.nih.gov/Microb_blast/unfinishedgenome.html]
- WU-BLAST version 2.0 [http://blast.wustl.edu/]
- University of Minnesota BLAST Server [http://www.cbc.umn.edu/cgi-bin/blasts/AGAC.restrict/blastn.cgi]
- Felsenstein J: **PHYLIP - Phylogeny Inference Package (Version 3.2).** *Cladistics* 1989, **5**:164-166.
- Swofford DL: **PAUP*. Phylogenetic Analysis Using Parsimony (*and Other Methods).** Version 4. 1998, Sinauer Associates, Sunderland, Massachusetts.
- Page RD: **TreeView: an application to display phylogenetic trees on personal computers.** *Comput Appl Biosci* 1996, **12**:357-358.
- The Sanger Centre : *M. tuberculosis* Genome Project [http://www.sanger.ac.uk/Projects/M_tuberculosis/]

48. **TIGR *Mycobacterium tuberculosis* CDC1551 Information**
[<http://www.tigr.org/tigr-scripts/CMR2/GenomePage3.spl?database=gmt>]
49. **TIGR BLAST Search Engine for Unfinished Microbial Genomes** [<http://www.tigr.org/cgi-bin/BlastSearch/blast.cgi?>]
50. **The Sanger Centre : *M. bovis* Genome Project**
[http://www.sanger.ac.uk/Projects/M_bovis/]
51. **Pasteur Institute Mycogenomics**
[<http://www.pasteur.fr/recherche/unites/Lgmb/mycogenomics.html>]
52. **The Sanger Centre : *Mycobacterium leprae* genome project**
[http://www.sanger.ac.uk/Projects/M_leprae/]
53. **Pasteur Institute Leproma** [<http://genolist.pasteur.fr/Leproma>]
54. **The Sanger Centre : *C. diphtheriae* Genome Project**
[http://www.sanger.ac.uk/Projects/C_diphtheriae/]
55. **The Sanger Centre : *S. coelicolor* Genome Project**
[http://www.sanger.ac.uk/Projects/S_coelicolor/]
56. Shinnick TM, Good RC: **Mycobacterial taxonomy.** *Eur J Clin Microbiol Infect Dis* 1994, **13**:884-901.