

Self-organization of meaning and the reflexive communication of information

Social Science Information

2017, Vol. 56(1) 4–27

© The Author(s) 2016



Reprints and permissions:

sagepub.co.uk/journalsPermissions.nav

DOI: 10.1177/0539018416675074

journals.sagepub.com/home/ssi



Loet Leydesdorff

Amsterdam School of Communication Research (ASCoR), University of Amsterdam, Amsterdam, The Netherlands

Alexander M. Petersen

Management Program, School of Engineering, University of California, Merced, California, USA

Inga Ivanova

Institute for Statistical Studies and Economics of Knowledge, National Research University Higher School of Economics (NRU HSE), Moscow, Russia

Abstract

Following a suggestion from Warren Weaver, we extend the Shannon model of communication piecemeal into a complex systems model in which communication is differentiated both vertically and horizontally. This model enables us to bridge the divide between Niklas Luhmann's theory of the self-organization of meaning in communications and empirical research using information theory. First, we distinguish between communication relations and correlations among patterns of relations. The correlations span a vector space in which relations are positioned and can be provided with meaning. Second, positions provide reflexive perspectives. Whereas the different meanings are integrated locally, each instantiation opens global perspectives – 'horizons of meaning' – along eigenvectors of the communication matrix. These next-order codifications of meaning can be expected to generate redundancies when interacting in instantiations. Increases in redundancy indicate new options and can be measured as local reduction of prevailing uncertainty (in bits). The systemic generation of new options can be considered as a hallmark of the knowledge-based economy.

Corresponding author:

Loet Leydesdorff, Amsterdam School of Communication Research (ASCoR), University of Amsterdam, PO Box 15793, 1001 NG Amsterdam, The Netherlands.

Email: l.a.leydesdorff@uva.nl

Keywords

codification, horizontal and vertical differentiation, redundancy, reflection, triple helix

Résumé

Suivant une suggestion de Warren Weaver, nous étendons le modèle de communication au coup par coup de Shannon à un modèle de systèmes complexes où la communication est différenciée à la fois verticalement et horizontalement. Ce modèle nous permet de combler le fossé entre la théorie de l'auto-organisation du sens dans les communications de Luhmann et la recherche empirique qui utilise la théorie de l'information. Tout d'abord, nous établissons une distinction entre relations de communication et corrélations entre distributions de relations. Les corrélations couvrent un espace vectoriel où les relations sont positionnées et où l'on peut leur attribuer un sens. Deuxièmement, les positions offrent des perspectives réflexives. Alors que les différents sens sont intégrés localement, chaque instantiation ouvre des perspectives globales – des horizons de sens – le long des vecteurs propres de la matrice de communication. On peut s'attendre à ce que ces codifications de sens voisines puissent générer des redondances mutuelles lorsqu'elles interagissent en instantiations. L'augmentation des redondances indique de nouvelles options et peut être mesurée comme une réduction locale de la prévalence de l'incertitude (en bits). La génération systémique de nouvelles options peut être considérée comme la marque de fabrique de l'économie de la connaissance.

Mots-clés

codification, différenciation horizontale et verticale, redondance, réflexion, triple hélice

Introduction

In his contribution to Shannon and Weaver's book, *The Mathematical Theory of Communication*, Warren Weaver stated (1949: 27) that '[t]he concept of information developed in this theory at first seems disappointing and bizarre – disappointing because it has nothing to do with meaning ...'. However, the author added that Shannon's analysis 'has so penetratingly cleared the air that one is now, perhaps for the first time, ready for a real theory of meaning'. But how can one relate a theory of meaning to Shannon's information theory (cf. Bar-Hillel & Carnap, 1953)? More recently, Niklas Luhmann (1995c [1984]) argued that meaning (*Sinn*) self-organizes in terms of communications among human beings. From this perspective, meaning is generated in interactions among communications. As Luhmann (1996: 261) formulated it: 'My argument is: it is not human beings who can communicate, rather, only communication can communicate.' However Luhmann's theory has remained far from operationalization and measurement.

Following Bateson's (1972: 315) alternative definition of information as 'a difference which makes a difference' (cf. MacKay, 1969), Luhmann (1984: 102ff, 1995c[1984]: 67f) considered information as implying a selection: a difference can only make a difference for a system of reference that selects this difference from among other possible differences. Others have also defined information with reference to a receiving system

(e.g. an observer). Varela (1979: 266) even argued that, since the word 'information' is derived from 'in-formare', the semantics call for the specification of a system of reference to be informed. 'Information', however, is then considered a substantive concept that varies with the system of reference instead of a formal measure of the uncertainty prevailing in a distribution. Kauffman et al. (2008: 28), for example, defined information as 'natural selection assembling the very constraints on the release of energy that then constitutes work and the propagation of organization'. In summary, using Bateson's alternative definition of information, the meaning of 'information' becomes dependent on the theoretical context. Using the same word (information) for different concepts has led to considerable confusion in the literature.

In an assessment of this confusion, Hayles (1990: 59f) compared the discussion with asking whether a glass is half empty or half full. As she noted, confusion can be avoided by using the words 'uncertainty' or 'probabilistic entropy' when Shannon-type information is meant. In our opinion, the advantage of measuring uncertainty – and redundancies, as we shall argue – in bits of information cannot be underestimated, since the operationalization and the measurement provide avenues to hypothesis testing and thus control of the theorizing (Theil, 1972). Note that uncertainty cannot be specified in terms of Bateson's definition, but his 'a difference which makes a difference' can be operationalized and measured in terms of (potentially negative) bits of information (Brillouin, 1962; Von Foerster, 1960).

Can Luhmann's theory about interacting communications and the self-organization of meaning also be made compatible with Shannon's information theory? Is it possible to specify how information and meaning are related? In this study, we aim to contribute to bridging this gap between a focus on meaning versus uncertainty processing by decomposing the problem using Herbert Simon's (1973a) model of complex systems that are both vertically and horizontally differentiated, as follows:

1. In the vertical dimension, we follow Luhmann's (e.g. 1975, 2000) distinction between (i) interactions among communications providing variation; (ii) the organization of meanings in historical instantiations; and (iii) the self-organization of reflexive meaning generating a next level of 'horizons of meaning' as global systems of reference (Husserl, 1960[1929]; cf. Luhmann, 1995b). Despite this inspiration from Luhmann, however, we also deviate from his framework and argue that the construction in terms of layers is bottom-up from the (probabilistic) informational level; but the emerging system's levels can be expected to take over control in terms of codified intentionalities and expectations. In other words, the operation in layers can also be described in terms of variation and selection mechanisms.

For example, a scholarly communication (e.g. a manuscript) can be expected to contain a knowledge claim. Knowledge claims provide in this case the historical variation. When the manuscript is submitted, an editorial process is instantiated in which referee comments, editorial judgments, etc. are combined. The referees, however, are expected to judge the manuscript in terms according with the standards of the field invoking the codes of communication that can be expected to control the process. The instantiation requires a reflexive reorganization of the codes.

One can consider the constructs from two sides, the first being the constructing agency (in history) and the second being the resulting constructs themselves, which can only be entertained reflexively (Giddens, 1979).¹ Because of this reflexive status, the processing (e.g. sharing of meaning) is volatile and cannot be observed directly; but the operations can be specified. On the basis of this specification, one is able to identify and measure the ‘footprints’ of the self-organizing dynamics in historical instantiations.

In other words, intentions and intentional systems cannot be found as observables in *res extensa* – or ‘matter’ – but can only be hypothesized reflexively in *res cogitans* – ‘thought’ (Husserl, 1960[1929]; Luhmann, 1990). Entertaining such hypotheses can enrich our expectations by providing frames for inferences about observations. The consequent possibility of an inversion in the order of control from the material conditions to systems of expectations enables reflexive agents – human beings – to operate infra-reflexively across (vertical) levels and among (horizontal) compartments by changing their perspectives on the complexity (Latour, 1988; Pickering, 1995).

2. In the horizontal direction, we follow Talcott Parsons’ (1968) proposal to consider the functional differentiation and symbolic generalization of the codes of communication as drivers of the increasing complexity in cultural evolution. Recalling another intuition of Simon (1973a: 19ff), one can expect an alphabet of these codes; for example, power, love, truth, law, art, etc. Because of the various codes operating, the same communication can mean something quite different in terms of its affective value, its truth value, or how power is reproduced in communications (Künzler, 1987; Luhmann, 1974, 2013[1997]; Parsons, 1963a, 1963b, 1968). The complexity is increased because the codes are also recombined in their instantiations (Hoffmeyer & Emmeche, 1991).

A dynamics of differentiation among the codes versus integration in instantiations is thus to be specified. Based on decoding and recoding, for example, differently codified expectations about markets and technologies can be recombined into new technological options (Arthur, 2009; Cowan & Foray, 1997). A technological evolution can thus be generated as a retention mechanism of the cultural evolution of possible expectations (Dubois, 2003).

The generation of meaning from (Shannon-type) information

How can the processing of meaning be conceptualized by elaborating on Shannon’s theory despite the author’s explicit statement that the ‘semantic aspects of communication are irrelevant to the engineering problem’ (Shannon, 1948: 3)? As a first step in the specification of the relevance of Shannon’s engineering model for developing a theory of meaning, Weaver (1949: 26) proposed two ‘minor additions’ to Shannon’s well-known diagram of a communication channel (Figure 1), as follows:

One can imagine, as an addition to the diagram, another box labeled ‘Semantic Receiver’ interposed between the engineering receiver (which changes signals to messages) and the

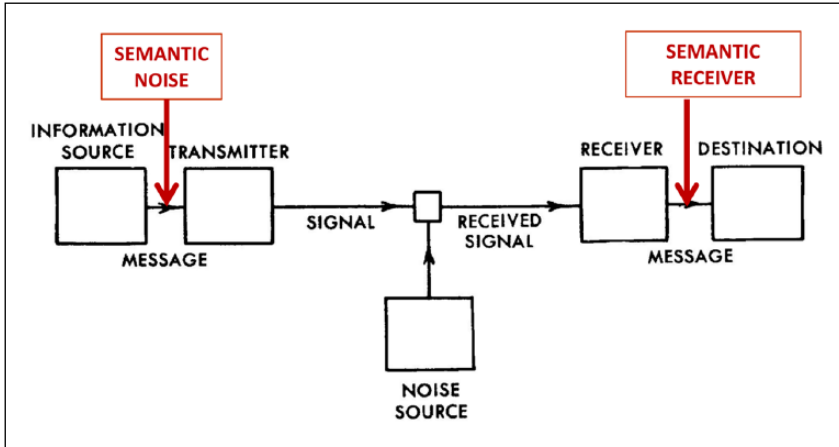

Figure 1. Weaver's (1949) 'minor' additions penciled into Shannon's (1948) original diagram. Source: adapted from Shannon (1948).

destination. This semantic receiver subjects the message to a second decoding, the demand on this one being that it must match the statistical semantic characteristics of the message to the statistical semantic capacities of the totality of receivers, or of that subset of receivers which constitute the audience one wishes to affect.

Similarly one can imagine another box in the diagram which, inserted between the information source and the transmitter, would be labeled 'Semantic Noise', the box previously labeled as simply 'noise' now being labeled 'Engineering Noise'. From this source is imposed into the signal the perturbations or distortions of meaning which are not intended by the source but which inescapably affect the destination. And the problem of semantic decoding must take this semantic noise into account.

Since the 'semantic receiver' recodes the information in the messages (received from the 'engineering receiver', who only changes signals into messages) while having to assume the possibility of 'semantic noise', a semantic relationship between the two new boxes can also be envisaged. Given Shannon's framework, however, this relation cannot be considered as another information transfer – since semantics are defined as *external* to Shannon's engineering model.

Semantics are not based on specific communications, but on relations among *patterns of relations* or, in other words, correlations. Two competing firms, for example, may have highly correlating patterns of relations with clients, but no relation with each other (Burt, 1982). The correlations among the distributions span a vector space in a topology different from the network space of relations (Appendix).² Two synonyms, for example, can have the same position (and meaning) in the vector space, yet never co-occur in a single sentence as a relation. Meanings can be shared also without a direct relation.

In the case of a single relation, the relational distance is not different from the correlational one; but in the case of relations involving three (or more) agents, the distances in

the vector space are different from the Euclidean distances in the network space. Simmel (1902) already noted that the transition from a group of two to three is qualitative. In a triplet, the instantiation of one or the other relation can make a difference for the further development of the triadic system of relations.

A system of relations can be considered as a semantic domain (Maturana, 1978). In other words, the sender and receiver are related in the graph of Figure 1, while they are correlated in terms of not necessarily instantiated relations in the background. The structure of correlations provides a latent background that provides meaning to the information exchanges in relations.³ The correlations are based on the same information, but the representation in the vector space is different from the graph in the network space of observable relations. In other words, meaning is not added to the information, but the same information is delineated differently and considered from a different perspective (including absent relations, i.e. zeros in the distribution). As against Shannon-type information which flows linearly from the sender to the receiver, one can expect meanings to loop, and thereby, to develop next-order dimensionalities (Krippendorff, 2009a, 2009b; Leydesdorff, 2010).

The third and fourth dimensions of the probabilistic entropy

A matrix of communications is shaped when one adds a second dimension (of codes) to the single vector of communication in Figure 1. A matrix can also be considered as a two-dimensional probability distribution – different from the one-dimensional probability distribution in a vector. When the communication matrix – of information processing and meaning processing – is repeated over time, one obtains a three-dimensional array because time is added as a third dimension (Figure 2a). In such a three-dimensional array, the development of information can also be considered in terms of trajectories; the uncertainty is then organized historically (over time). A four-dimensional array or hypercube of information is more difficult to imagine or represent graphically: unlike a (three-dimensional) trajectory, a four-dimensional array can contain a next-order regime that feeds back on its historical development along trajectories (Dosi, 1982).

One can consider the next-order regime as having one more degree of freedom, which allows it to select among the possible trajectories in three dimensions as representations of its past (Figure 2b). This additional selection implies a reflection by the system. The reflection is performative in the present and can therefore be considered as the self-organization of an adaptive system. In the four-dimensional system, one representation of its history in three dimensions can be acknowledged (weighted) more than another.

We can consider ourselves as psychologies with the reflexive capacity to reconstruct the possible representations of our history. Luhmann (e.g. 1986b) suggested modeling the social system of communications as a system without psychological consciousness, but with an equal level of complexity. Whereas a psychological system is centered on the *individuum* and will therefore tend to integration (Haken & Portugali, 2014), the communication system is distributed (as a '*dividuum*'; Luhmann, 1984: 625; cf. Nietzsche, 1967[1878]: 76) and has the option of exploiting the additional degree of freedom for differentiation. Different from a high culture, the modern society is based on prevailing

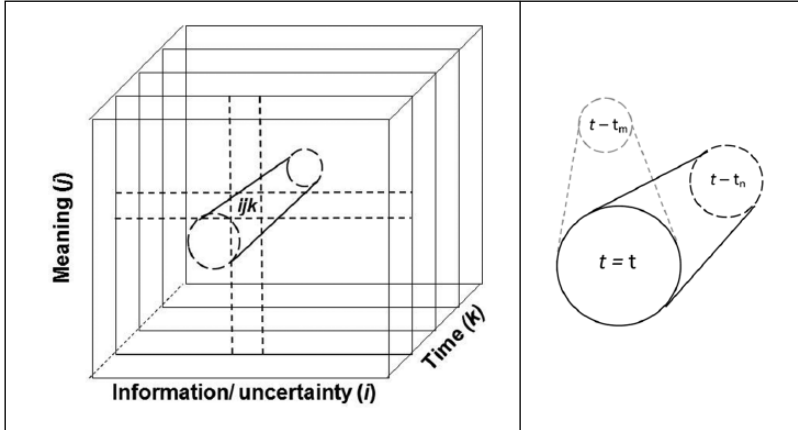

Figure 2a (left) and 2b (right). A three-dimensional array of information can contain a trajectory; a four-dimensional hypercube contains one more degree of freedom and thus a variety of possible trajectories.
 Source: Adapted from Leydesdorff (1996: 289).

differentiation among codes of communication, so that a set of juxtaposed coordination mechanisms can be used. The different coordination mechanisms are partially integrated when the systems are instantiated in terms of historical organization and action.

In terms of evolution theory, the coordination mechanisms (e.g. the market) can also be considered as selection mechanisms that operate with different criteria. The recursion of selection at the structural level leads to second-order variation: selections can be selected for stabilization (in history), and some stabilizations can be selected for globalization (at the regime level). For subsequent selections, however, the historical origin of a variation is not always relevant. Thus the system of expectations may continuously loop into itself at different levels and from different perspectives.

Levels B and C in the Shannon diagram

Weaver (1949: 24) suggested taking Shannon’s original diagram as a representation of ‘level A’, which can be complemented with more levels (B and C) that represent how meaning is conveyed at level B, and how and why the received meaning can affect behavior (at level C). Elaborating on Shannon’s model and Weaver’s addition as depicted in Figure 1, we propose Figure 3 as a scheme for levels B and C.

We specified above that the relation between the semantic receiver and semantic noise is based on correlations among sets of relations at level A. In the vector space (level B), meanings can be shared but not communicated (because otherwise one operates at level A). The use of language facilitates, supports and potentially reinforces the options for sharing meaning. Natural languages (at level B), however, can be considered as the yet-undifferentiated and therefore common medium of communication. Codes of communication are used at the symbolic level C for regulating the use of language. The codes

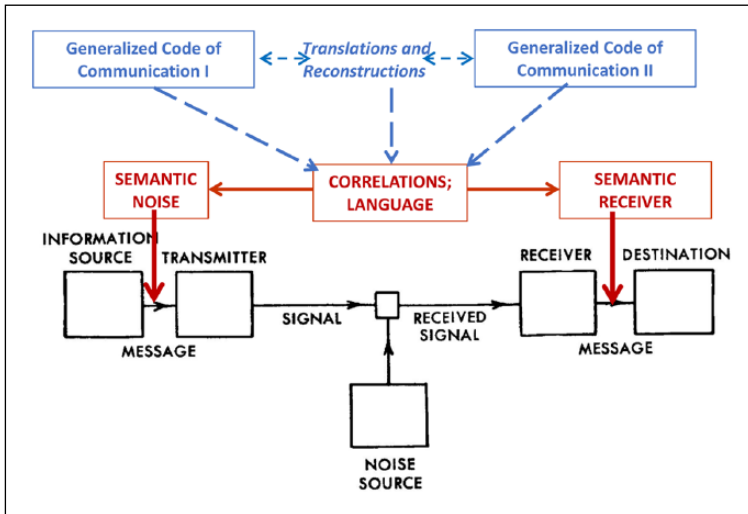

Figure 3. Levels B and C added to the Shannon diagram (in red-brown and dark-blue, respectively). Source: adapted from Shannon (1948).

enable us, among other things,⁴ to shortcut the communication; for example, by paying the market price of a good instead of negotiating this price using language. In our opinion, the codes of communication are thus candidates for Weaver's level C: the codes and their combinations enable us to make the communications far more precise and efficient than is possible in natural languages.

Parsons (1968: 440) provided a sociological appreciation of the operations at level C as follows:

At the cultural level [language] is clearly the fundamental matrix of the whole system of media. Large-scale social systems, however, contain more specialized media (if you will, specialized 'languages'), such as money, power, and influence (see Parsons 1963a,b). Such media, like language, *control* behavior in the processes of interaction.

In addition to symbolic, Parsons (1963a, 1963b, 1968) characterized these media as 'generalized', with a reference to Mead's (1934: 154ff) 'generalized other'. Luhmann (1974) further argued that 'symbolically generalized media of communication' would have to be binary – like true and false in logics – in order to be binding (Luhmann, 1984: 316f, 1995a: 233f; cf. Künzler, 1987: 329ff). In our opinion, the codes can be more complex than one-dimensional and binary (Hoffmeyer & Emmeche, 1991). For example, Herbert Simon (1973a) argued in favor of truth-finding and puzzle-solving as combined 'logics' in scientific discovery. However this operationalization has also remained chiefly a philosophical appreciation of the evolutionary process (cf. Popper, 1959[1935]) more than a proposal for empirical operationalization (cf. Newell & Simon, 1972).

In our opinion, the sciences evolve as systems of expectations rationalized by arguments in discourses; after a further development, the criteria may also have changed

(Fujigaki, 1998; Kuhn, 1962). Using the conceptualization of the codes as the latent dimensions (principal components or ‘eigenvectors’;⁵ Von Foerster, 1960; cf. Von Glasersfeld, 2008: 64 n4) of the communication matrix, one can appreciate the uncertain and evolving character of these codes of communications. From this perspective, the designation of these structures remains a historical appreciation.

For example, in the case of the science system, Luhmann (1990) argued for true/not-true as the code that provides a binary criterion for quality control in scholarly discourse. However, in the empirical sciences, the truth of statements is not unambiguous: some statements can be more true or less false than others. Since the sciences develop as discursive knowledge, uncertainty is always present. In a study of the debates about oxidative phosphorylation – which led to the Nobel Prize in Chemistry for Peter Mitchell in 1978 – Gilbert & Mulkay (1984) found that statements were relabeled using different repertoires when they were considered true or erroneous from the perspective of hindsight.

Codes can also be nested. For example, different specialties may operate with different codes while sharing some general criteria for the quality control of scholarly communications. Similarly in economic transactions a variety of payment methods can be distinguished under the umbrella of an economic logic that differs from a scholarly or normative one (Boudon, 1979; Bourdieu, 1976).

In his last book, Pierre Bourdieu (2004: 83) precisely formulated a reflection on the empirical study of the sciences, as follows:

Each field (discipline) is the site of a specific legality (a *nomos*), a product of history, which is embodied in the objective regularities of the functioning of the field and, more precisely, in the mechanisms governing the circulation of information, in the logic of the allocation of rewards, etc., and in the scientific habitus produced by the field, which are the condition of the functioning of the field. ...

What are called epistemic criteria are the formalization of the ‘rules of the game’ that have to be observed in the field, that is, of the sociological rules of interactions within the field, in particular, rules of argumentation or norms of communication. Argumentation is a collective process performed before an audience and subject to rules.

Bourdieu (2004: 78) calls this a ‘Kantian’ – that is, transcendental – transition from ‘objectivity’ to ‘intersubjectivity’ as the carrying ground of scientific inferences. However, the philosopher most associated with this transition is Edmund Husserl, who criticized the increasingly empiristic self-understanding of the modern (European) sciences (Husserl, 1962[1935–36]). According to Husserl (1960[1929]: 155), the possibility to communicate expectations intersubjectively grounds the empirical sciences ‘in a concrete *theory of science*’. One tests expectations entertained at the supra-individual level (in discourses) against observations, and the observations can update the expectations since they can function as arguments.

We shall take from Husserl the proposition that the self-organizing codes of the communication at level C are not material, but belong to our reality as structures of expectations or *res cogitans*. Popper (1972) denoted this domain as ‘World 3’, but neither he nor Husserl specified the evolutionary dynamics of expectations in terms of communications (Luhmann, 1986a). We submit that *res cogitans* can be expected to develop in terms of

redundancies instead of probabilistic entropy, unlike the material world (*res extensa*), where the Second Law of thermodynamics prevails.

Language and the symbolic media of communication enable us to multiply meanings as options at a speed much faster than can historically be realized. The codes of communication provide us with horizons of other possible meanings. The different codes can be recombined and reconstructed in translations among differently coded meanings. We shall argue that at level B meanings are instantiated in specific combinations of codes, while at level C the codes evolve in response to the historical integrations in the instantiations.

The transformation of hitherto ‘impossible’ options into technologically feasible ones

Whereas historical developments unfold with the arrow of time – and are necessarily related to the generation of entropy – expectations enable us to use possible future states in the present, i.e. against the arrow of time. The dynamics of expectations therefore are very different from organizational dynamics. Under specifiable conditions, the interactions among differently coded expectations can generate redundancy (that is, negative entropy). Redundancy enriches a system with new options that are available for realization.

The redundancy R is defined in information theory as the fraction of the capacity of a communication channel that is not used. In formula format:

$$\begin{aligned}
 R &= 1 - \frac{H}{H_{\max}} \\
 &= \frac{H_{\max} - H}{H_{\max}}
 \end{aligned}
 \tag{1}$$

As is well known, Shannon’s (1948) probabilistic entropy (H) is coupled to Gibbs’ formula for thermodynamic entropy $S = k_B * H$. In Gibbs’ equation, k_B is the Boltzmann constant that provides the dimensionality Joule/Kelvin to S , while H is dimensionless and can be measured in bits of information (or any other base of the logarithm) given a probability distribution (containing uncertainty). The Second Law of thermodynamics states that entropy increases with each operation, and Shannon-type information is accordingly always positive.

Brooks and Wiley (1986) noted that, in the case of an evolving (e.g. biological) system, not only the observed (probabilistic) entropy (H_{obs}) of the system increases, but also the maximum entropy ($H_{\max} = \ln N$) – that is, the system’s capacity – increases as the total number of possible options (states) N also increases. The difference between the maximum entropy and the realized entropy is provided by the options that are available but have not yet been used. From the perspective of information theory, these surplus options are redundant. Using Brooks and Wiley’s (1986: 43) illustration in Figure 4a, we added green to the redundancy as part of the evolving entropy. Redundancy provides a

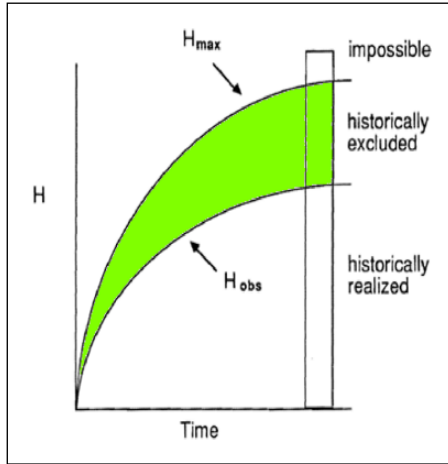

Figure 4a. The development of entropy (H_{obs}), maximum entropy (H_{max}), and redundancy ($H_{max} - H_{obs}$).
 Source: Adapted from Brooks & Wiley (1986: 43).

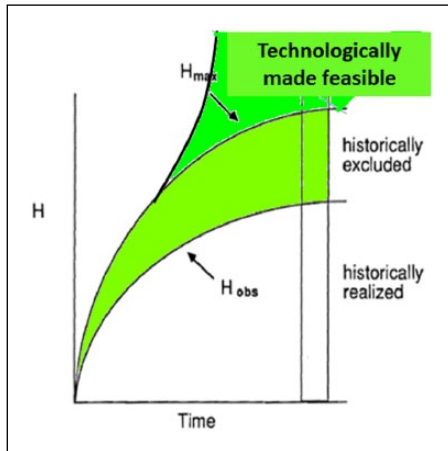

Figure 4b. Hitherto impossible options are made possible because of cultural and technological evolution. Adapted from Brooks & Wiley (1986:43).

measure of the options that were not realized by the system but could have been realized. Kauffman (2000), for example, called these possible realizations ‘adjacent’.

Above the green area, Brooks and Wiley (1986: 43) added the legend ‘impossible’ (Figure 4a). In Figure 4b, we have added the domain ‘technologically made feasible’ to this latter area in order to introduce how the generation of new options (and hence increased redundancy) can be enhanced by a model of cultural evolution that includes levels B and C. An intentional system operates by adding new options (redundancy) without necessarily realizing them.

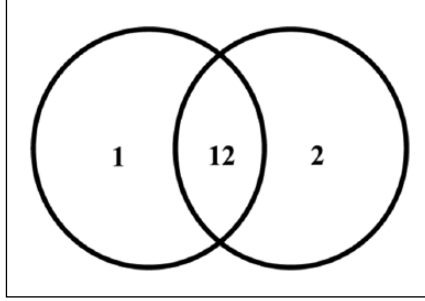

Figure 5. Overlapping uncertainties in two variables x_1 and x_2 .

The codes regulate the generation of redundancies at interfaces from above, whereas Shannon entropy is continuously generated in the historical process from below. The latter process is linear, whereas expectations can circulate before being organized in realizations. Redundancy is generated when two (or more) perspectives on the same information are operating at an interface, as in the case of introducing a new technology in a market or when writing a report based on scholarly arguments for a government agency. In such cases, one needs text that can be read using the various codes involved (Fujigaki & Leydesdorff, 2000). The redundancy represented by the green surfaces of Figure 4b is generated by the recombination of sufficiently different expectations. Let us try to specify this process in information-theoretical terms.

Mutual redundancy between two differently coded systems

In Figure 5, the overlap between uncertainties in two variables x_1 and x_2 is depicted as two sets. The mutual information or transmission (T_{12}) is then defined in information theory as follows:

$$T_{12} = H_1 + H_2 - H_{12} \quad (2)$$

Note that the addition of entropies accords with the rules of set theory. Alternatively one can consider the overlap as a redundancy: the same information is then appreciated twice. In addition to H_1 and H_2 , the overlap contains redundancy as a surplus of information, as follows:

$$Y_{12} = H_1 + H_2 + T_{12} = H_{12} + 2T_{12} \quad (3)$$

The mutual redundancy R_{12} at the interface between the two sets can now be found by using Y_{12} instead of H_{12} in Equation 2, as follows:

$$\begin{aligned} R_{12} &= H_1 + H_2 - Y_{12} \\ &= H_1 + H_2 - (H_{12} + 2T_{12}) \\ &= H_1 + H_2 - ([H_1 + H_2 - T_{12}] + 2T_{12}) \\ &= -T_{12} \end{aligned} \quad (4)$$

Since T_{12} is necessarily positive (Shannon, 1948: 53), it follows from Equation 4 that R_{12} is always negative and therefore by definition a redundancy. This reduction of the uncertainty can be measured in bits of information with a negative sign. In other words, the redundancy cannot be a Shannon-type information since the latter information is necessarily positive (Krippendorff, 2009b). Using mutual redundancy, one no longer measures a historical process – generating uncertainty – but a process in the realm of expectations: future states are represented in the present (Dubois, 1998).

Redundancy in three and four dimensions

For the three-dimensional case and using Figure 6, one can define, in addition to the two-dimensional values of Y (in Equation 3), a three-dimensional value including the redundancies in the respective overlaps as follows:

$$Y_{123} = H_1 + H_2 + H_3 + T_{12} + T_{13} + T_{23} + T_{123} \quad (5)$$

Using information theory, however, one would make the following corrections for double counting in the overlaps (by subtracting; see Figure 6):

$$H_{123} = H_1 + H_2 + H_3 - T_{12} - T_{13} - T_{23} + T_{123} \quad (6)$$

It follows that the difference between the uncertainty in the historical system (H_{123} in Eq. 6) and the system of expectations (Y_{123} in Eq. 5) is:

$$\begin{aligned} Y_{123} - H_{123} &= 2T_{12} + 2T_{13} + 2T_{23} \\ Y_{123} &= H_{123} + 2T_{12} + 2T_{13} + 2T_{23} \end{aligned} \quad (7)$$

Furthermore the mutual information in three dimensions can be derived in information theory using the Shannon formulas (e.g. Abramson, 1963: 129; McGill, 1954; Yeung, 2008) as:

$$T_{123} = H_1 + H_2 + H_3 - H_{12} - H_{13} - H_{23} + H_{123} \quad (8)$$

Using Y -values instead of H -values for the joint entropies in Equation 8, one obtains the mutual redundancy in three dimensions as follows:

$$\begin{aligned} R_{123} &= H_1 + H_2 + H_3 - (H_{12} + 2T_{12}) - (H_{13} + 2T_{13}) - (H_{23} + 2T_{23}) \\ &\quad + (H_{123} + 2T_{12} + 2T_{13} + 2T_{23}) \\ &= T_{123} \end{aligned} \quad (9)$$

In the three-dimensional case, the mutual redundancy is thus equal to the mutual information in three dimensions. Furthermore Leydesdorff and Ivanova (2014: 392) show that, in the case of four dimensions, $R_{1234} = -T_{1234}$. The sign of the mutual redundancy alternates with the number of dimensions. This corrects for the otherwise inexplicable sign changes in the mutual information with increasing dimensionality. This sign change of the mutual information with dimensions is a well-known problem in

information theory, but beyond the scope of the present study.⁶ In other words, mutual redundancy is a consistent measure of negative entropy, while mutual information is not, because of its sign changes with the dimensionality. We prove this claim in the next section by generalizing the formulation.

Generalization

Equation 8 can be rewritten as follows:

$$\begin{aligned}
 T_{123} &= H_1 + H_2 + H_3 - H_{12} - H_{13} - H_{23} + H_{123} & (8) \\
 T_{123} &= \left[(H_1 + H_2 - H_{12}) + (H_1 + H_3 - H_{13}) + (H_2 + H_3 - H_{23}) \right] \\
 &\quad + \left[H_{123} - H_1 - H_2 - H_3 \right] \\
 T_{123} &= \left[T_{12} + T_{13} + T_{23} \right] + \left[H_{123} - H_1 - H_2 - H_3 \right] & (10)
 \end{aligned}$$

The second bracket in Equation 10 makes a negative contribution, because of the subadditivity of the entropy: $H(x_1, \dots, x_n) \leq \sum_1^n H(x_i)$, which holds for any dimension $n \geq 2$.

The terms in the first bracket of Equation 10 are strictly positive. As noted, the sign of the resulting value of T_{123} depends on the empirical configuration (as indicated by the two configurations in Figure 6).

It follows (inductively) that, for any given dimension n , one can formulate combinations of mutual information corresponding to $\sum_1^n H(x_i) - H(x_1, \dots, x_n)$ that are by definition positive (or zero in the null case of complete independence). For example (up to four dimensions) as follows:

$$\begin{aligned}
 0 &\leq \sum_{i=1}^{n=2} H(x_i) - H(x_1, x_2) = T_{12} \\
 0 &\leq \sum_{i=1}^{n=3} H(x_i) - H(x_1, x_2, x_3) = \sum_{ij}^3 T_{ij} - T_{123} & (11) \\
 0 &\leq \sum_{i=1}^{n=4} H(x_i) - H(x_1, x_2, x_3, x_4) = \sum_{ij}^6 T_{ij} - \sum_{ijk}^4 T_{ijk} + T_{1234}
 \end{aligned}$$

where the sums on the right-hand side are over the $\binom{n}{k}$ permutations of the indices. This relation can be extended for general n as,

$$\begin{aligned}
 0 &\leq \sum_{i=1}^n H(x_i) - H(x_1, \dots, x_n) \\
 &= \sum_{ij}^{\binom{n}{2}} T_{ij} - \sum_{ijk}^{\binom{n}{3}} T_{ijk} + \sum_{ijkl}^{\binom{n}{4}} T_{ijkl} - \dots + (-1)^{1+n} \sum_{ijkl\dots(n-1)}^{\binom{n}{n-1}} T_{ijkl\dots(n-1)} + (-1)^n \sum_{ijkl\dots(n)}^{\binom{n}{n}} T_{ijkl\dots(n)} & (12)
 \end{aligned}$$

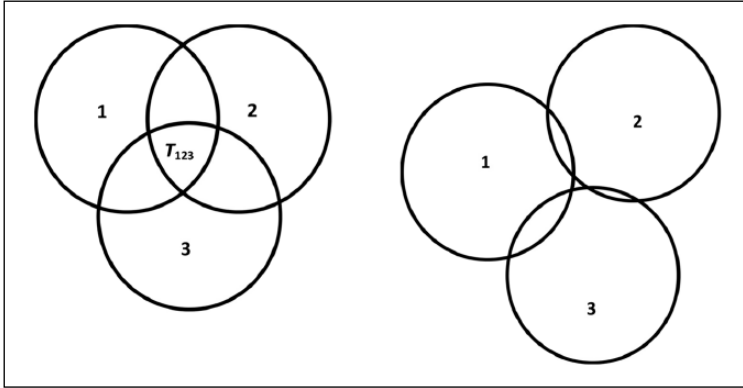

Figure 6. Overlapping uncertainties in three variables x_1 , x_2 , and x_3 : two configurations with opposite sign of T_{123} .

where the last term on the right-hand side is equal to $(-1)^n T_{1234\dots n}$. Returning to the relation between R_{12} and T_{12} , it now follows instructively that:

$$\begin{aligned}
 R_{12} &= -T_{12} \\
 &= H(x_1, x_2) - \sum_1^2 H(x_i) \leq 0
 \end{aligned}
 \tag{13}$$

and the analogous relations for R_{123} and R_{1234} follow in the same way from Equation 12. More generally, in the case of more than two dimension, $n > 2$:

$$\begin{aligned}
 R_n &= (-1)^{1+n} T_{1234\dots n} = \left[H(x_1, \dots, x_n) - \sum_1^n H(x_i) \right] \\
 &+ \left[\sum_{ij} \binom{n}{2} T_{ij} - \sum_{ijk} \binom{n}{3} T_{ijk} + \sum_{ijkl} \binom{n}{4} T_{ijkl} - \dots + (-1)^{1+n} \sum_{ijkl\dots(n-1)} \binom{n}{n-1} T_{ijkl\dots(n-1)} \right]
 \end{aligned}
 \tag{14}$$

The left-bracketed term of Equation 14 is necessarily negative entropy (because of the subadditivity of the entropy), while the configuration of the remaining mutual information relations contributes a second term on the right, which is positive (see the set of Equations 11 above). In other words, we model here the generation of redundancy on the one side versus the historical process of uncertainty generation in relating on the other as an empirical balance in a system that operates with more than two codes (e.g. alphabets; Abramson, 1963: 127ff). When the resulting R is negative, self-organization prevails over organization in the configuration under study, whereas a positive R indicates conversely a pre-dominance of organization over self-organization as two different subdynamics.

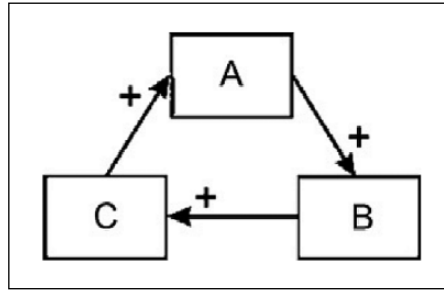

Figure 7. Schematic of a hypothetical three-component autocatalytic cycle.

Source: Ulanowicz (2009: 1888, Figure 3).

Clockwise and anti-clockwise rotations

When the relation between two subdynamics (or agents) is extended with a third, the third may feed back or feed forward on the communication relation between the two, and thus a system is shaped (Sun & Negishi, 2010). This principle is known in social network analysis as ‘triadic closure’ (Bianconi et al., 2014; De Nooy & Leydesdorff, 2015). Triadic closure can be considered as the basic mechanism of systems formation. When three selection environments operate on variation in the interactions among them, the communication can proliferate auto-catalytically using each third mechanism as a feedback on or feed-forward to bi-lateral relations. At a next moment, the cycling itself may take control as a vortex (Ivanova & Leydesdorff, 2014b).

Ulanowicz (2009: 1888) depicted this possibility of auto-catalysis as shown in Figure 7.

A second cycle with the reverse order of the operations is equally possible; the two cycles can be modeled as two vectors with three dimensions (A, B and C), and this system can then be simulated in terms of rotations of the two vectors. One vector can be understood as corresponding to the tendency of historical realization and the other to self-organization. Using simulations, Ivanova and Leydesdorff (2014a) showed that the operation of these two three-dimensional vectors upon each other generates a value of R depending on the configuration. As we showed above, R can also be measured.

The one sign of R can be associated with clockwise and the other with anti-clockwise rotation, whereas the values of the two terms in Equation 14 measure the relative weights of the two rotations. In other words, mutual redundancy indicates the size of the footprint of the self-organizing fluxes of communication on the historical organization in the instantiation. The cycles can be vicious or virtuous in the sense of providing opportunities or exploiting existing ones.

Summary and conclusions

We have extended Shannon’s model of communication (at level A) with two levels (B and C), which change the linear model into an evolutionary one because feedback and feed-forward loops are possible among the levels. At level A, information is transmitted; at level B, information is organized and thus made meaningful in a vector-space.

Reflexivity reveals that this vector space is constructed and therefore a potential subject of reconstruction: the possibility of reconstruction opens horizons of meaning (level C). These horizons can be expected to evolve along the eigenvectors of the communication matrix in different directions. Whereas the common language at level B tends to integration (into organization), horizontal differentiation among the codes at level C increases the communication capacity of the system.

Codes of communication are no longer actor-attributes, but operate on the communications reflexively – that is, by co-constructing the meaning of the communication (Luhmann, 1984). In other theoretical contexts, one can also consider the codes as virtual coordination mechanisms (e.g. Giddens' structuration theory) or as selection mechanisms (e.g. Dosi, 1982; Nelson & Winter, 1982). As Andersen (1992: 14) noted, specification of 'What is evolving?' becomes a relevant question when selection is no longer given by nature (cf. Boulding, 1978: 33). The question arises: Under what conditions can the different selection mechanisms be expected to co-evolve and lead to new options for realizing innovations?

We showed that redundancies could be generated at interfaces among systems as sets of relations that are structured by codes, whereas in historical relations (instantiations) variety is generated. Biological evolution theory assumes *variation* as a driver and *selection* to be naturally given, while cultural evolution is driven by individuals and groups who make conscious decisions on the basis of potentially different criteria (Newell & Simon, 1972; Petersen et al., 2016).

Note that the interactions among the codes in the instantiations generate the redundancies. In Luhmann's theory, these interactions are held to be impossible: the binary codes close the autopoiesis of systems and subsystems operationally. Whereas biological systems gain in complexity by closing themselves operationally, systems of expectations can disturb one another 'infra-reflexively' (Latour, 1988: 169ff). Cultural evolution can therefore be much faster than biological evolution. The 'avoidance of redundancy' is an objective in Luhmann's model of autopoiesis and functional differentiation (e.g. 2013[1997]: 98), whereas redundancy generation is considered crucial for the advancement of society in our model. Redundancy provides new options for technological development that are not yet realized but can be envisaged.

In addition to vertical differentiation, the assumption of horizontal differentiation is needed for understanding the evolving complexity. The differentiation and the ensuing pluriformity of the competing coordination mechanisms break the structural formations of autopoietic systems so that the established meanings can be interrupted by other possible meanings. The generation of redundancy can thus enter the historical instantiations and, under the condition of self-reinforcing loops, can thereby tip the balance toward the prevalence of evolutionary self-organization over historical organization. We have shown how the trade-off between historical organization and self-organization over time can be traced by the measurement of mutual redundancies.

When three or more selection mechanisms operate, auto-catalysis is an option, and options can then be generated at an increasing pace. Thus horizontal differentiation is a necessary component of self-organization in the vertical dimension. The warp and the woof of organization of and self-organization are not harmoniously integrated, as in textiles, but differentiated and disturbing of one another. The layers are not hierarchical, but operate in parallel. These horizontal and vertical dynamics lead to a fractal

manifold in different directions. Through breakages (and hence puzzles) new options can be generated.

The generation of redundancy proceeds in a domain of expectations about options that do not (yet) exist, but that one can reflexively entertain. By turning away from an objectivistic self-understanding of the sciences, we find room for a general theory of meaning and knowledge-generation, which we have depicted as an extension of Shannon's theory (Figure 3). Whereas Shannon felt the need to explicitly deny this extension, Weaver understood it as the theory's proper intension.

Acknowledgements

The authors would like to thank the EU COST Action TD1210 'KnowEscape' for its support. Inga Ivanova also thanks the Basic Research Program at the National Research University Higher School of Economics (HSE) and the Russian Academic Excellence Project '5-100' for their support.

Funding

This research received no specific grant from any funding agency in the public, commercial, or not-for-profit sectors.

Notes

1. In Giddens' structuration theory, these next-order structures are considered as rules and resources. From this perspective, structures exist only as memory traces, the organic basis of human knowledgeability, and as instantiated in action (Giddens, 1984: 177). Giddens (1979: 81f) formulates this as follows: 'The communication of meaning in interaction does not take place separately from the operation of relations of power, or outside the context of normative sanctions. ... [P]ractices are situated within intersecting sets of rules and resources that ultimately express features of the totality.'
2. Each pattern of relations can be considered as a vector. When two vectors stand orthogonally in the vector space, the correlation is zero. See the Appendix for further explanation.
3. 'Structures exist paradigmatically, as an absent set of differences, temporarily "present" only in their instantiations, in the constituting moments of social systems' (Giddens, 1979: 64).
4. Spelling rules, syntax and pragmatics can also be considered as codes in the use of language, but we focus on the semantics.
5. Using linear algebra: for any function f , if a and λ exist such that $f(a) = \lambda f(a)$, then a is called the eigenvector and λ the eigenvalue (Achterbergh & Vriens, 2009: 84n). In the case of a communication matrix W , $WA = \lambda A$ with A as eigenvector and λ as eigenvalue. Eigenvectors can also be considered as pointing to densities consequential to the recursive operations of self-organizing systems (von Foerster, 1960, 1982).
6. Krippendorff (2009a: 670) provided a general *notation* for this alteration with changing dimensionality – but with the opposite sign (which further complicate the issue; cf. Leydesdorff, 2010: 68) – as follows:

$$Q(\Gamma) = \sum_{X \subseteq \Gamma} (-1)^{1+|\Gamma|-|X|} H(X) \quad (9)$$

In this equation, Γ is the set of variables of which X is a subset, and $H(X)$ is the uncertainty of the distribution; $|\Gamma|$ is the cardinality of Γ , and $|X|$ the cardinality of X .

References

- Abramson N (1963) *Information Theory and Coding*. New York, NY: McGraw-Hill.
- Achterbergh J, Vriens D (2009) *Organizations: Social systems conducting experiments*. Dordrecht: Springer Verlag.
- Andersen ES (1992) *Artificial Economic Evolution and Schumpeter*. Aalborg: Institute for Production, University of Aalborg.
- Arthur WB (2009) *The Nature of Technology*. New York, NY: Free Press.
- Bar-Hillel Y, Carnap R (1953) Semantic information. *British Journal for the Philosophy of Science* 4(14): 147–157.
- Bateson G (1972) *Steps to an Ecology of Mind*. New York, NY: Ballantine.
- Bianconi G, Darst RK, Iacovacci J, Fortunato S (2014). Triadic closure as a basic generating mechanism of communities in complex networks. *Physical Review E* 90(4): 042806.
- Boudon R (1979) *La logique du social*. Paris: Hachette.
- Boulding KE (1978) *Ecodynamics: A new theory of societal evolution*. Beverly Hills, CA: Sage.
- Bourdieu P (1976) Le champ scientifique. *Actes de la recherche en sciences sociales* 2(2): 88–104.
- Bourdieu P (2004) *Science of Science and Reflexivity*. Chicago, IL: University of Chicago Press.
- Brillouin L (1962) *Science and Information Theory*. New York, NY: Academic Press.
- Brooks DR, Wiley EO (1986) *Evolution as Entropy*. Chicago, IL/London: University of Chicago Press.
- Burt RS (1982) *Toward a Structural Theory of Action*. New York, NY: Academic Press.
- Cowan R, Foray D (1997) The economics of codification and the diffusion of knowledge. *Industrial and Corporate Change* 6: 595–622.
- De Nooy W, Leydesdorff L (2015) The dynamics of triads in aggregated journal–journal citation relations: Specialty developments at the above-journal level. *Journal of Informetrics* 9(3): 542–554. doi: 10.1016/j.joi.2015.04.005.
- Dosi G (1982) Technological paradigms and technological trajectories: A suggested interpretation of the determinants and directions of technical change. *Research Policy* 11(3): 147–162.
- Dubois DM (1998) Computing anticipatory systems with incursion and hyperincursion. In: Dubois DM (ed.) *Computing Anticipatory Systems, CASYS-First international conference*. Woodbury, NY: American Institute of Physics (vol. 437), 3–29.
- Dubois DM (2003) Mathematical foundations of discrete and functional systems with strong and weak anticipations. In: Butz MV, Sigaud O, Gérard P (eds) *Anticipatory Behavior in Adaptive Learning Systems*. Berlin: Springer-Verlag (Lecture Notes in Artificial Intelligence, vol. 2684), 110–132.
- Fujigaki Y (1998) Filling the gap between discussions on science and scientists' everyday activities: Applying the autopoiesis system theory to scientific knowledge. *Social Science Information* 37(1): 5–22.
- Fujigaki Y, Leydesdorff L (2000) Quality control and validation boundaries in a triple helix of university–industry–government: 'Mode 2' and the future of university research. *Social Science Information* 39(4): 635–655.
- Giddens A (1979) *Central Problems in Social Theory*. London: Macmillan.
- Giddens A (1984) *The Constitution of Society*. Cambridge: Polity Press.
- Gilbert GN, Mulkay MJ (1984) *Opening Pandora's Box. A sociological analysis of scientists' discourse*. Cambridge: Cambridge University Press.
- Haken H, Portugali J (2014) *Information Adaptation: The interplay between Shannon information and semantic information in cognition*. Heidelberg: Springer.
- Hayles NK (1990) *Chaos Bound: Orderly disorder in contemporary literature and science*. Ithaca, NY: Cornell University Press.

- Hoffmeyer J, Emmeche C (1991) Code-duality and the semiotics of nature. In: Anderson M, Merrell F (eds) *On Semiotic Modeling*. Berlin/New York, NY: Mouton de Gruyter, 117–166.
- Husserl E (1960[1929]) *Cartesiansche Meditationen und Pariser Vorträge* [Cartesian Meditations and the Paris Lectures], trans. Cairns D. The Hague: Martinus Nijhoff.
- Husserl E (1962[1935–36]) *Die Krisis der Europäischen Wissenschaften und die Transzendente Phänomenologie* [Crisis of the European Sciences and Transcendental Phenomenology]. The Hague: Martinus Nijhoff.
- Ivanova IA, Leydesdorff L (2014a) Redundancy generation in university–industry–government relations: The triple helix modeled, measured, and simulated. *Scientometrics* 99(3): 927–948. doi: 10.1007/s11192-014-1241-7.
- Ivanova IA, Leydesdorff L (2014b) Rotational symmetry and the transformation of innovation systems in a triple helix of university–industry–government relations. *Technological Forecasting and Social Change* 86: 143–156.
- Kauffman SA (2000) *Investigations*. Oxford: Oxford University Press.
- Kauffman S, Logan RK, Este R, Goebel R, et al. (2008) Propagating organization: An enquiry. *Biology and Philosophy* 23(1): 27–45.
- Krippendorff K (2009a) Information of interactions in complex systems. *International Journal of General Systems* 38(6): 669–680.
- Krippendorff K (2009b) W. Ross Ashby’s information theory: A bit of history, some solutions to problems, and what we face today. *International Journal of General Systems* 38(2): 189–212.
- Kuhn TS (1962) *The Structure of Scientific Revolutions*. Chicago, IL: University of Chicago Press.
- Künzler J (1987) Grundlagenprobleme der Theorie symbolisch generalisierter Kommunikationsmedien bei Niklas Luhmann [Foundational problems in Niklas Luhmann’s theory of symbolically generalized media of communication]. *Zeitschrift für Soziologie* 16(5): 317–333.
- Latour B (1988) The politics of explanation: An alternative. In: Woolgar S, Ashmore M (eds) *Knowledge and Reflexivity: New frontiers in the sociology of knowledge*. London: Sage, 155–177.
- Leydesdorff L (1996) Luhmann’s sociological theory: Its operationalization and future perspectives. *Social Science Information* 35(2): 283–306.
- Leydesdorff L (2010) Redundancy in systems which entertain a model of themselves: Interaction information and the self-organization of anticipation. *Entropy* 12(1): 63–79. doi:10.3390/e12010063.
- Leydesdorff L, Ivanova IA (2014) Mutual redundancies in inter-human communication systems: Steps towards a calculus of processing meaning. *Journal of the Association for Information Science and Technology* 65(2): 386–399.
- Luhmann N (1974) Einführende Bemerkungen zu einer Theorie symbolisch generalisierter Kommunikationsmedien [Introductory notes to a theory of symbolically generalized media of communication]. *Zeitschrift für Soziologie* 3(3): 236–255.
- Luhmann N (1975) Interaktion, Organisation, Gesellschaft: Anwendungen der Systemtheorie [Interaction, Organization, Society: Application of Systems Theory]. In: Gerhardt M (ed.) *Die Zukunft der Philosophie* [The Future of Philosophy]. München: List, 85–107.
- Luhmann N (1984) *Soziale Systeme. Grundriß einer allgemeinen Theorie* [Social Systems: Basic framework of a general theory]. Frankfurt a. M: Suhrkamp.
- Luhmann N (1986a) Intersubjektivität oder Kommunikation: Unterschiedliche Ausgangspunkte soziologischer Theoriebildung [Intersubjectivity or Communication: Distinguishable starting points for sociological theory-construction]. *Archivio di Filosofia* 54(1–3): 41–60.
- Luhmann N (1986b) The autopoiesis of social systems. In: Geyer F, Zouwen J v.d. (eds) *Sociocybernetic Paradoxes*. London: Sage, 172–192.

- Luhmann N (1990) *Die Wissenschaft der Gesellschaft* [The Science of Society]. Frankfurt a.M.: Suhrkamp.
- Luhmann N (1995a) *Die neuzeitlichen Wissenschaften und die Phänomenologie* [The Modern Sciences and Phenomenology]. Vienna: Picus.
- Luhmann N (1995b) Intersubjektivität oder Kommunikation: Unterschiedliche Ausgangspunkte soziologischer Theoriebildung [Intersubjectivity or Communication: Distinguishable starting points for sociological theory-construction]. *Soziologische Aufklärung* 6: 169–188.
- Luhmann N (1995c[1984]) *Social Systems*. Palo Alto, CA: Stanford University Press.
- Luhmann N (1996) On the scientific context of the concept of communication. *Social Science Information* 35(2): 257–267.
- Luhmann N. (1997). *Die Gesellschaft der Gesellschaft* [The Society of Society]. Frankfurt a.M.: Suhrkamp.
- Luhmann N (2000) *Organisation und Entscheidung* [Organization and Decision]. Opladen: Westdeutscher Verlag.
- Luhmann N (2013[1997]) *Theory of Society*, Vol. 2. Palo Alto, CA: Stanford University Press.
- MacKay DM (1969) *Information, Mechanism and Meaning*. Cambridge, MA/London: MIT Press.
- Maturana HR (1978) Biology of language: The epistemology of reality. In: Miller GA, Lenneberg E (eds) *Psychology and Biology of Language and Thought. Essays in Honor of Eric Lenneberg*. New York, NY: Academic Press, 27–63.
- McGill WJ (1954) Multivariate information transmission. *Psychometrika* 19(2): 97–116.
- Mead GH (1934) *Mind, Self, & Society from the Standpoint of a Social Behaviourist. Works of G.H. Mead*. Chicago, IL: University of Chicago Press.
- Nelson RR, Winter SG (1982) *An Evolutionary Theory of Economic Change*. Cambridge, MA: Belknap Press of Harvard University Press.
- Newell A, Simon HA (1972) *Human Problem Solving*. Englewood Cliffs, NJ: Prentice-Hall.
- Nietzsche F (1967[1878]) *Menschliches, allzumenschliches: ein Buch für freie Geister* [Human, All too Human. A book for free spirits]. Berlin: Walter de Gruyter & Co.
- Parsons T (1963a) On the concept of influence. *Public Opinion Quarterly* 27 (Spring): 37–62.
- Parsons T (1963b) On the concept of political power. *Proceedings of the American Philosophical Society* 107(3): 232–262.
- Parsons T (1968) Interaction, I: Social interaction. In: Sills DL (ed.), *The International Encyclopedia of the Social Sciences*, Vol. 7. New York, NY: McGraw-Hill, 429–441.
- Petersen A, Rotolo D, Leydesdorff L (2016) A triple helix model of medical innovations: *Supply, Demand, and Technological Capabilities* in terms of medical subject headings. *Research Policy* 45(3): 666–681. doi: 10.1016/j.respol.2015.1012.1004.
- Pickering A (1995) *The Mangle of Practice: Time, agency, and science*. Chicago, IL: University of Chicago Press.
- Popper KR (1959[1935]) *The Logic of Scientific Discovery*. London: Hutchinson.
- Popper KR (1972) *Objective Knowledge: An evolutionary approach*. Oxford: Oxford University Press.
- Salton G, McGill MJ (1983) *Introduction to Modern Information Retrieval*. Auckland: McGraw-Hill.
- Schiffman SS, Reynolds ML, Young FW (1981) *Introduction to Multidimensional Scaling: Theory, methods, and applications*. New York, NY: Academic Press.
- Shannon CE (1948) A mathematical theory of communication. *Bell System Technical Journal* 27: 379–423, 623–656.
- Simmel G (1902) The number of members as determining the sociological form of the group, I. *American Journal of Sociology* 8: 1–46.
- Simon HA (1973a) Does scientific discovery have a logic? *Philosophy of Science* 40(4): 471–480.

- Simon HA (1973b) The organization of complex systems. In: Pattee HH (ed.) *Hierarchy Theory: The challenge of complex systems*. New York, NY: George Braziller Inc., 1–27.
- Sun Y, Negishi M (2010) Measuring the relationships among university, industry and other sectors in Japan's national innovation system: A comparison of new approaches with mutual information indicators. *Scientometrics* 82(3): 677–685.
- Theil H (1972) *Statistical Decomposition Analysis*. Amsterdam: North Holland.
- Ulanowicz RE (2009) The dual nature of ecosystem dynamics. *Ecological Modelling* 220(16): 1886–1892.
- Varela FJ (1979) *Principles of Biological Autonomy*. Amsterdam: North Holland.
- Von Foerster H (1960) On self-organizing systems and their environments. In: Yovits MC, Cameron S (eds) *Self-Organizing Systems*. London: Pergamon Press, 31–50.
- Von Foerster H (1982) *Observing Systems*, with an introduction by Francisco Varela, ed. Seaside, CA: Intersystems Publications.
- Von Glasersfeld E (2008) Who conceives of society? *Constructivist Foundations* 3(2): 59–64.
- Weaver W (1949) Some recent contributions to the mathematical theory of communication. In: Shannon CE, Weaver W (eds) *The Mathematical Theory of Communication*. Urbana, IL: University of Illinois Press, 93–117.
- Yeung RW (2008) *Information Theory and Network Coding*. New York, NY: Springer.

Author biographies

Loet Leydesdorff is Professor Emeritus at the Amsterdam School of Communication Research (ASCoR) of the University of Amsterdam. He has published extensively in scientometrics, the sociology of innovation, second-order dynamics (of links instead of nodes) and on the triple helix of university–industry–government relations (see at <http://www.leydesdorff.net/list.htm>). His research interest focuses on the communication of information, meaning and knowledge in scholarly discourse.

Alexander M. Petersen, who holds a doctorate in physics, is an Assistant Professor in the Management program at the University of California Merced. His research focuses on the evolution of large multiscale socio-economic systems, applying concepts and methods from complex systems, statistical physics, management and innovation science.

Inga Ivanova obtained her doctorate in economics. She is a researcher at the Institute for Statistical Studies and Economics of Knowledge of the National Research University Higher School of Economics (NRU HSE) in Moscow and an Associate Professor at the School of Economics and Management of the Far-Eastern Federal University in Vladivostok. Her research interests focus on self-organization in complex social-economic systems, innovation and knowledge management.

Appendix

As an example of a set of relations that can be formalized within a coordinate system (vector space) defined by relations, consider two agents or firms A and B with similar relations to agents/clients [C1, C2, C3], but no relations between them. In the case of a triple-helix configuration, C1, C2 and C3 can be a university, another firm and the government, respectively. A and B can be represented as two vectors constructed as follows:

| | A | B | C1 | C2 | C3 |
|--------|---|---|----|----|----|
| Firm A | 1 | 0 | 1 | 0 | 1 |
| Firm B | 0 | 1 | 1 | 0 | 1 |

The Pearson correlation between these two distributions is $r = 0.167$ (*n.s.*). A natural measure of similarity between vectors is the cosine of the angle between them; in this case, $\cos(A,B) = 0.667$. Figure A1 represents the relations in a three-dimensional Euclidean space of, for example, university–industry–government relations.

Using the vectors themselves as non-orthogonal axes, one can span a vector space (Salton & McGill, 1983: 120ff, Figure A2).

The vector space can be multi-dimensional; the dimensionality is determined by the number of vectors. Eigenvectors can be considered as vectors pointing to the centroids of clusters in a space reducing the dimensionality of the vector space (using, e.g. factor analysis or multi-dimensional scaling; Schiffman et al., 1981). See also note 5 above.

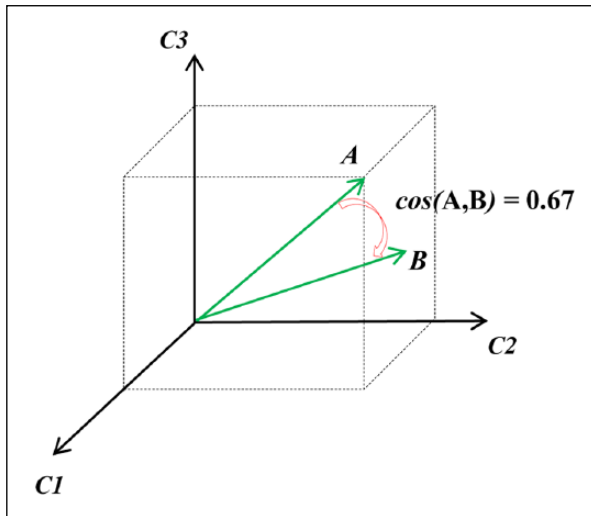

Figure A1. The two distributions as vectors in a three-dimensional ('triple helix') space. Source: Ivanova & Leydesdorff (2014a: 930).

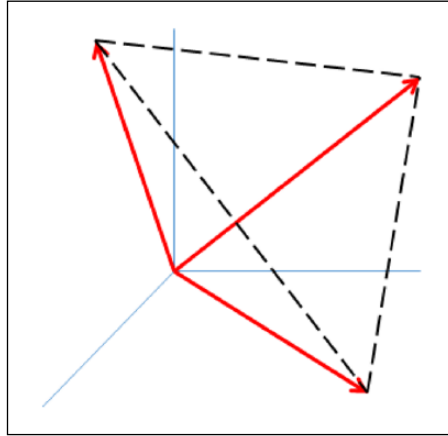

Figure A2. Vector space in the case of three vectors.