

## ORIGINAL RESEARCH

# Combined effects of global climate change and nutrient enrichment on the physiology of three temperate maerl species

Zujaila Nohemy Qui-Minet<sup>1</sup>  | Jérôme Coudret<sup>1</sup> | Dominique Davoult<sup>1</sup>  | Jacques Grall<sup>2</sup> | Miguel Mendez-Sandin<sup>1</sup>  | Thierry Cariou<sup>3</sup> | Sophie Martin<sup>1</sup> 

<sup>1</sup>Sorbonne Universités, CNRS, UMR 7144 Adaptation et Diversité en Milieu Marin, Station Biologique de Roscoff, Roscoff, France

<sup>2</sup>Université de Bretagne Occidentale, IUEM, Plouzané, France

<sup>3</sup>Sorbonne Universités, CNRS, FR2424, Station Biologique de Roscoff, Roscoff, France

## Correspondence

Zujaila Nohemy Qui-Minet, CNRS, UMR 7144 Adaptation et Diversité en Milieu Marin, Station Biologique de Roscoff, Place Georges Teissier, 29680 Roscoff, France. Email: znquiminet@sb-roscoff.fr

## Funding information

Consejo Nacional de Ciencia y Tecnología, Grant/Award Number: 391572; French National Research Agency, Grant/Award Number: ANR-10-BTBR-04

## Abstract

Made up of calcareous coralline algae, maerl beds play a major role as ecosystem engineers in coastal areas throughout the world. They undergo strong anthropogenic pressures, which may threaten their survival. The aim of this study was to gain insight into the future of maerl beds in the context of global and local changes. We examined the effects of rising temperatures (+3°C) and ocean acidification (−0.3 pH units) according to temperature and pH projections (i.e., the RCP 8.5 scenario), and nutrient (N and P) availability on three temperate maerl species (*Lithothamnion corallioides*, *Phymatolithon calcareum*, and *Lithophyllum incrustans*) in the laboratory in winter and summer conditions. Physiological rates of primary production, respiration, and calcification were measured on all three species in each treatment and season. The physiological response of maerl to global climate change was species-specific and influenced by seawater nutrient concentrations. Future temperature–pH scenario enhanced maximal gross primary production rates in *P. calcareum* in winter and in *L. corallioides* in both seasons. Nevertheless, both species suffered an impairment of light harvesting and photoprotective mechanisms in winter. Calcification rates at ambient light intensity were negatively affected by the future temperature–pH scenario in winter, with net dissolution observed in the dark in *L. corallioides* and *P. calcareum* under low nutrient concentrations. Nutrient enrichment avoided dissolution under future scenarios in winter and had a positive effect on *L. incrustans* calcification rate in the dark in summer. In winter conditions, maximal calcification rates were enhanced by the future temperature–pH scenario on the three species, but *P. calcareum* suffered inhibition at high irradiances. In summer conditions, the maximal calcification rate dropped in *L. corallioides* under the future global climate change scenario, with a potential negative impact on CaCO<sub>3</sub> budget for maerl beds in the Bay of Brest where this species is dominant. Our results highlight how local changes in nutrient availability or irradiance levels impact the response of maerl species to global climate change and thus point out how it is important to consider other abiotic parameters in order to develop management policies capable to increase the resilience of maerl beds under the future global climate change scenario.

This is an open access article under the terms of the Creative Commons Attribution License, which permits use, distribution and reproduction in any medium, provided the original work is properly cited.

© 2019 The Authors. *Ecology and Evolution* published by John Wiley & Sons Ltd.

## KEYWORDS

calcification, maerl, nitrate, ocean acidification, ocean warming, phosphate, photosynthesis, respiration

## 1 | INTRODUCTION

The coastal system is under severe threat and is considered as one of the most vulnerable environments due to the strong influence of global and local anthropogenic pressures. Global climate change is expected to affect abundance, diversity, and productivity of marine populations (Barange & Harris, 2003), thus becoming a major driver of the future state of marine ecosystems (Duarte et al., 2013). Atmospheric carbon dioxide (CO<sub>2</sub>) concentrations have risen from 278 parts per million (ppm) at the start of the Industrial Revolution to the current level of 410 ppm. Approximately, one-third of CO<sub>2</sub> emissions are absorbed by the ocean and affect its chemistry and physics (Gattuso et al., 2015), causing a global average increase in temperature of 0.8°C and a decline in pH of 0.1 units of the surface oceans since the industrial revolution, phenomena known as ocean warming and ocean acidification (OA), respectively (Gattuso et al., 2015). Marine coastal ecosystems are also influenced by other, more local anthropogenic pressures, which are growing due to various human activities in coastal areas. Considering this, coastal eutrophication is attributed to the enrichment of nutrients such as phosphates and nitrates resulting from agricultural runoff or wastewater discharged into the sea via rivers (Diaz-Pulido & McCook, 2008; Duarte et al., 2013; Russel & Connell, 2009; Salisbury, Green, Hunt, & Campbell, 2008; Strong, Kroeker, Teneva, Mease, & Kelly, 2014).

Global climate change is expected to alter dominance relationships among primary producers, in particular between calcifying and noncalcifying macroalgal species (Brodie et al., 2014; Celis-Plá et al., 2015; Falkenberg, Connell, & Russel, 2013). However, these changes will depend on local factors such as nutrient availability (Celis-Plá et al., 2015; Fabry, Seibel, Feely, & Orr, 2008). Red calcareous coralline macroalgae are among the most sensitive organisms to OA (Martin & Hall-Spencer, 2017) because they precipitate high-magnesium calcite, which is the most soluble form of biogenic calcium carbonate (CaCO<sub>3</sub>) (Morse, Andersson, & Mackenzie, 2006). Among them, free-living nongeniculate red coralline algae, called rhodoliths or maerl, are distributed in coastal ecosystems throughout the world (Foster, 2001) and experience different levels of pH and temperature changes depending on their location (Qui-Minet et al., 2018). Previous studies on maerl and other red coralline algae have given insights into their individual responses to OA and warming, which are useful for a better understanding of how species physiology responds to these factors alone or in combination. Although the responses of coralline algae are species-specific (Martin, Charnoz, & Gattuso, 2013; Noisette, Egilisdottir, Davoult, & Martin, 2013; Vazquez-Elizondo & Enriquez, 2016), most studies have revealed adverse effects of the combination of ocean acidification and warming on coralline algal physiology (Martin & Hall-Spencer, 2017).

Owing that productivity is limited by nutrient availability, moderate nutrient enrichment can benefit algae by reducing nutrient limitation and allowing them to cope with the metabolic cost of adapting to global climate change (Celis-Plá et al., 2015; Hofmann, Heiden, Bischof, & Teichberg, 2014). However, nutrient enrichment can threaten maerl survival and favor the development of fleshy epiphytic macroalgae (Grall & Hall-Spencer, 2003; Steller, Riosmena-Rodríguez, Foster, & Roberts, 2003). Research focusing on the effect of nutrient enrichment under current conditions of pH and temperature in coralline algae has reported that increased nitrate concentrations do not affect photosynthesis and calcification (Belliveau & Paul, 2002; Bjork, Mohammed, Bjorklund, & Semesi, 1995). However, phosphates have been described as “crystal poison” since they have shown to act as an inhibitor of calcification and growth of coralline algae (Bjork et al., 1995; Kinsey & Davies, 1979; Simkiss, 1964). Studies specifically addressing the interaction of global climate change with nutrient enrichment on the physiology of coralline algae are scarce, and none have explored the response of maerl species.

Maerl beds in the Bay of Brest (Brittany, France) are highly productive benthic systems (Martin, Clavier, Chavaud, & Thouzeau, 2007) subject to seasonal variations in physicochemical parameters (Salt et al., 2015, Qui-Minet et al., 2018). In the present study, we selected three maerl species co-occurring in the Bay of Brest: *Lithothamnion corallioides* (P. Crouan & H. Crouan) P. Crouan & H. Crouan, *Phymatolithon calcareum* (Pallas) W.H. Adey & D.L. McKibbin ex Woelkerling & L.M. Irvine, and *Lithophyllum incrustans* Philippi. These species are relevant because of the ecological role they play in the northeastern Atlantic. They are the main maerl species found in France, and *L. corallioides* and *P. calcareum* are also the main species forming maerl beds in Europe. Although all three species were collected at the same location and acclimated to the same conditions, their geographical distribution is not the same, with the northern limits of *P. calcareum* being found all the way to southern Norway, whereas the northern distribution of *L. corallioides* and *L. incrustans* stops in Ireland. Further, *L. incrustans* observes a more southern distribution (Hernández-Kantún et al., 2016), being present in the Caribbean (BIOMAERL, 1998; Hernández-Kantún et al., 2015; McCoy & Kamenos, 2015) and found in rock pool habitats subject to high variability in physicochemical parameters and exposed to high temperatures and low pH values at low tide (Egilisdottir, Noisette, Noël, Olafsson, & Martin, 2013; Legrand et al., 2018; Williamson et al., 2014). This species is rarely found below 8 m depth (Ford, Hardy, & Edyvean, 1983), whereas *L. corallioides* and *P. calcareum* are found in shallow environments, but also at depths up to 20 and 30 m, respectively (Birkett, Maggs, & Dring, 1998). In Brittany, *L. corallioides* and *P. calcareum* are the most

abundant species, whereas *L. incrustans* is present at lower abundances (Grall & Hall-Spencer, 2003). In the Bay of Brest, maerl beds are mainly formed by *L. corallioides* (Grall, 2002; Qui-Minet et al., 2018). In this bay, one maerl bed (Roz) presents all the three maerl species *L. corallioides*, *P. calcareum*, and *L. incrustans* together (Figure 1).

The purpose of this study was to test (a) the individual and combined effects of global climate change (ocean warming and acidification) and local nutrient loading on various species of maerl and (b) if different species coming from the same location respond similarly due to convergent adaptation. We considered present temperature–pH conditions and future temperature–pH conditions projected for 2,100 according to the representative concentration pathway RCP 8.5 global change scenario (Gattuso et al., 2015) as well as enrichment in nitrate ( $\text{NO}_3^-$ ) and phosphate ( $\text{PO}_4^{3-}$ ), the main nutrients originating from human activities affecting the Bay of Brest (Le Pape & Menesguen, 1997). To consider the potential seasonal variability of the response of maerl to OA and warming (Martin, Cohu, Vignot, Zimmerman, & Gattuso, 2013; Martin & Gattuso, 2009), we carried out our study under winter and summer conditions. We hypothesized that (a) the future scenario of ocean warming and acidification will negatively affect calcification in the three maerl species; (b) nutrient enrichment will exacerbate the impact of global climate change on the three species; and (c) although the three maerl species coexist in the same location and hence are adapted to the same environmental conditions, species-specific responses occur due to divergent ecological traits such as morphology and pigment concentrations.

## 2 | MATERIALS AND METHODS

### 2.1 | Collection site

The three maerl species, *L. corallioides*, *P. calcareum*, and *L. incrustans* (Figure 1), were collected in the Roz maerl bed (48°19'58"N,

04°19'57"W), located in the southern basin of the Bay of Brest (Brittany, France), where it covers a surface of 1.4 km<sup>2</sup> (Qui-Minet et al., 2018). The three here studied species are present in different abundances, being *L. corallioides* the most abundant and the only one distributed along the Bay of Brest.

Temperature and pH in the Bay of Brest average 10°C and 8.04 in the winter, and 18°C and 8.00 in the summer, respectively. Local nutrient conditions are strongly variable according to the season as reported by Le Pape and Menesguen (1997), and Qui-Minet et al. (2018); nitrate concentrations are significantly higher in winter ( $\pm 30 \mu\text{mol/L}$ ) relative to summer ( $< 1 \mu\text{mol/L}$ ) while phosphate concentrations remain below 1  $\mu\text{mol/L}$  during both summer and winter seasons. Incident irradiance in the Bay of Brest varies with tides. In the collection site, it can vary from  $< 1$  to 320  $\mu\text{mol photons m}^{-2} \text{s}^{-1}$  in winter and from 1 to 645  $\mu\text{mol photons m}^{-2} \text{s}^{-1}$  in the summer (Qui-Minet et al., 2018). The Roz bed is located at 0.7 m depth (chart datum), with maximal water depth amplitudes of 8 m (Daniel, 1995).

Physicochemical parameters also vary on a daily basis, in the summer in the Roz bed, temperature and pH can observe a mean variation of 0.7°C and 0.08 pH units, respectively (Qui-Minet et al., 2018).

### 2.2 | Biological material

Living specimens of the three species were collected with a 0.1 m<sup>2</sup> Van Veen grab in January 2016 (winter experiment) and in June 2016 (summer experiment). The algae were brought to the laboratory in a box filled with seawater (seawater temperature did not differ much from air temperature). After cleaning, thalli were randomly distributed into the aquaria of the experimental system and kept under in situ conditions of temperature and pH. In each aquarium, there were two sets of 5–7 g dry weight (DW) of *L. corallioides*, 5–7 g (DW) of *P. calcareum*, and 7–9 g (DW) of *L. incrustans* attached with a nylon wire and labeled with small plastic numbers and additional unlabeled thalli (approximately 10 g per species).

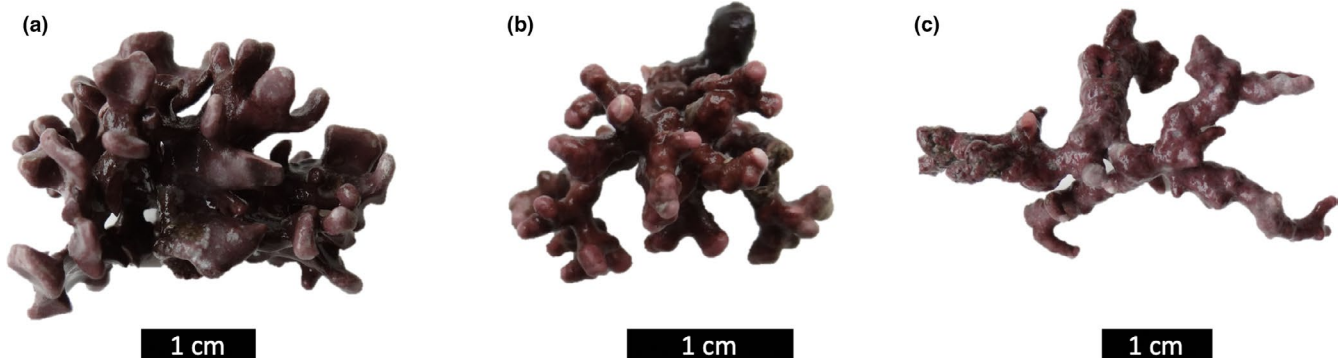

**FIGURE 1** Specimens of (a) *Lithothamnion corallioides*, (b) *Phymatolithon calcareum*, and (c) *Lithophyllum incrustans* collected in the Roz maerl bed in the Bay of Brest (Brittany, France) (photos Coralie Delaunay). Scale bars = 1 cm

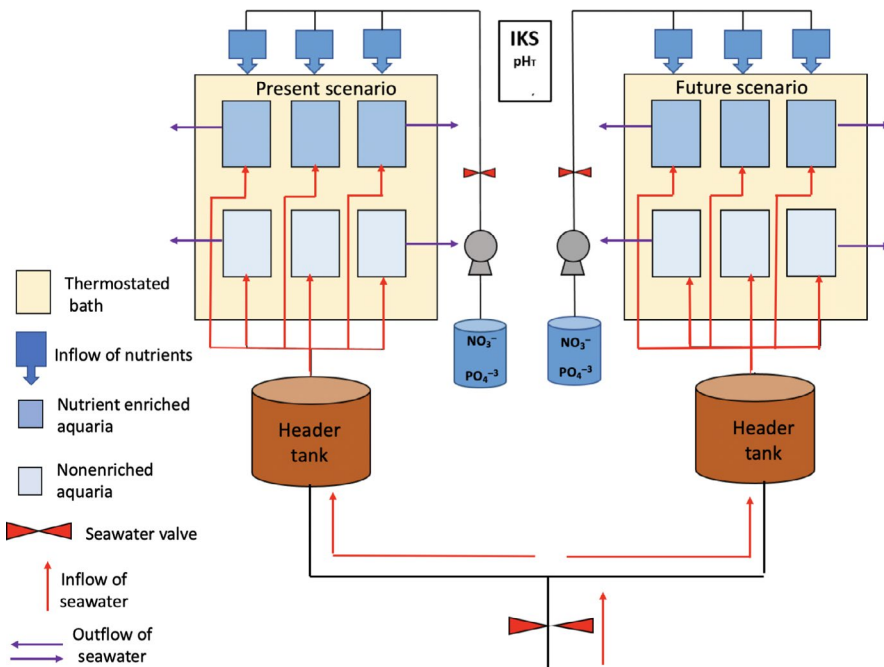

**FIGURE 2** Schematic diagram of the experimental laboratory setup with two scenarios: present pH and temperature and future (RPC 8.5) projected pH and temperature by 2,100. All aquaria were maintained at constant temperature in a thermostated bath. Each aquarium contained 2 sets of maerl thalli for each species

### 2.3 | Experimental conditions and setup

Two experiments were conducted for both winter (January–April 2016) and summer (June–September 2016) conditions. For each season, two scenarios of temperature and pH were chosen: a present scenario and a future scenario. Each temperature–pH test scenario was crossed with nutrient availability conditions, resulting in four different treatments: (a) present scenario-low nutrients concentrations (Pr-LN); (b) present scenario-high nutrients concentrations (Pr-HN); (c) future scenario-low nutrients concentrations (Fu-LN); and (d) future scenario-high nutrients concentrations (Fu-HN; Figure 2).

For the tested present temperature–pH conditions, temperature and pH were determined from mean values measured in situ in winter and summer (temperature: 10 and 18°C, respectively; pH on the total scale (pH<sub>T</sub>): 8.04 and 8.00, respectively) (Qui-Minet et al., 2018). Acclimation to the experimental system under controlled conditions lasted 3 weeks. For the tested projected future temperature–pH conditions, values were selected according to the future RCP 8.5 scenario (+2.7°C and –0.33 pH units; Gattuso et al., 2015). Temperature and pH were progressively increased and decreased by ~0.4°C and ~0.05 pH units, respectively, every 2 days during 2 weeks. An experimental thermostated system was set up for both temperature–pH scenarios (present and future). Each experimental system consisted of a thermostated bath containing six aquaria (10 L), three with nutrient enrichment and three without nutrient enrichment (12 aquaria in total; Figure 2). Aquaria were supplied at a rate of 9 L/hr from a 100 L header tank continuously supplied with filtered seawater pumped in front of the Roscoff Marine Biological Station (*Station Biologique de Roscoff*). Due to constraining space conditions, only one header tank was used per scenario. However, this was an open-flow system with filtered seawater (5 µm) and water renewal rate (~54 L/hr) with high cleaning frequency (weekly) in the

header tank to prevent any contamination event and tank effect. Nutrients were distributed continuously from a peristaltic pump to increase the concentrations of  $\text{PO}_4^{3-}$  and  $\text{NO}_3^-$  of 1 and 40 µmol/L, respectively, the mean values measured in the Bay of Brest (Qui-Minet et al., 2018). Concentrations of silicic acid ( $\text{Si}(\text{OH})_4^-$ ) were not controlled under either scenario and ranged from 1.1 to 2.8 µmol/L in winter and from 1.67 to 2.65 µmol/L in summer. Temperature inside the aquaria was adjusted with two cooling elements, one that controlled the temperature inside the 100 L header tank and another one that maintained the desired temperature inside the thermostated water bath. pH was monitored and controlled by an off-line feedback system (IKS Aquastar) that regulated the addition of  $\text{CO}_2$  in the 100 L header tanks. Ambient light was kept at 30 µmol photons  $\text{m}^{-2} \text{s}^{-1}$  with a light/dark photoperiod of 10/14 hr in winter and 14/10 hr in summer.

### 2.4 | Monitoring of the seawater parameters

Temperature and pH were measured on a daily basis; total alkalinity ( $T_A$ ) was measured every week, and nutrients were measured every 2 weeks. The pH values of the system were adjusted based on daily measurements of pH<sub>T</sub> and temperature in the 12 aquaria using a pH meter (HQ40D, Hach Lange, Ltd portable LDO™) calibrated with Tris/HCl and 2-aminopyridine/HCl buffers (Dickson, Sabine, & Christian, 2007). Samples for nutrient assays and  $T_A$  analyses were collected from filtered water using 0.22 µm Sterivex cartridges (Millipore). Samples for  $\text{NO}_3^-$ ,  $\text{PO}_4^{3-}$ , and  $\text{Si}(\text{OH})_4^-$  analyses were frozen at –20°C until analysis, and ammonium ( $\text{NH}_4^+$ ) samples were stored in 100 ml borosilicate glass bottles. Samples were treated with mercuric chloride (0.02% v/v; Dickson, Afghan, & Anderson, 2003) and stored in a dark, cool place. Analysis of  $\text{NO}_3^-$ ,  $\text{PO}_4^{3-}$ , and

Si(OH)<sub>4</sub> concentrations were done by spectrophotometry using a Technicon autoanalyzer according to Aminot and K erouel (2007). NH<sub>4</sub><sup>+</sup> concentrations were determined using the Solorzano (1969) method. T<sub>A</sub> was measured by 0.01 N HCl potentiometric titration on an automatic titrator (Titroline alpha, Schott Si Analytics) calibrated on the National Bureau of Standards scale and by using the Gran method of nonlinear least-squares fit applied to pH variations from 3.5 to 3.0 mEq/L (Dickson et al., 2007). The T<sub>A</sub> measurements were corrected using standards provided by A.G. Dickson (Batch 111) and had a reproducibility of ±4 µmol/kg. Dissolved inorganic carbon (DIC), pCO<sub>2</sub>, calcite (Ω<sub>Ca</sub>), and aragonite (Ω<sub>Ar</sub>) were calculated from triplicates values of temperature, pH<sub>T</sub>, salinity, pressure, silicate, and phosphate concentrations, by using the software CO<sub>2</sub>sys, Excel Macro version 2.1 (originally designed by Lewis & Wallace, 1998). Calculations were based on a set of constants K1 and K2 from Mehrbach, Culberson, Hawley, & Pytkowicz (1973) refitted by Dickson & Millero (1987).

### 2.5 | Metabolic rate measurements

Metabolic measurements were performed after 3 months of culture in each treatment. Net primary production (NPP) and net calcification rates in light (G<sub>l</sub>) were measured at an ambient irradiance of 30 µmol photons m<sup>-2</sup> s<sup>-1</sup>. Respiration (R) and net calcification rates in the dark (G<sub>D</sub>) were measured in dark at the beginning or at the end of the day. Net primary production (NPP) and net calcification (G) versus irradiance (E) curves were defined for the three maerl species only in the nonenriched nutrient condition (Pr-LN and Fu-LN) in winter (under irradiances of 0, 30, 50, 100, 200, and 400 µmol photons m<sup>-2</sup> s<sup>-1</sup>) and in summer (under irradiances of 0, 30, 70, 150, 320, and 600 µmol photons m<sup>-2</sup> s<sup>-1</sup>) conditions. NPP and G versus E curves in the nutrient-enriched conditions (Pr-HN and Fu-HN) were only performed for *L. corallioides* in summer. Incubations were done in 185 ml acrylic respirometry chambers (Engineering & Design Plastics Ltd). Chambers contained a plastic grid above a stir bar (100 rpm) which ensured water homogeneity. Control incubations without algae were carried out to correct fluxes from biological activity in seawater. Incubations lasted between 1 and 2.5 hr to maintain oxygen saturation above 80%, and pH changes lower than 0.1 pH units during incubation. NPP and R were estimated by measuring oxygen concentrations at the beginning and at the end of incubation with a noninvasive optical fiber system (FIBOX 3, PreSens). Reactive oxygen spots of the chambers were calibrated before the incubations with 0% and 100% oxygen buffers. Calcification rates were estimated using the alkalinity anomaly technique (Smith & Key, 1975), which is a good estimator for short-term incubations. It is based on a decrease of two moles total alkalinity (T<sub>A</sub>) by two equivalents per molecule of CaCO<sub>3</sub> precipitated (Wolf-Gladrow, Zeebe, Klaas, Kortzinger, & Dickson, 2007). Seawater was sampled at the beginning and at the end of incubation, and analyses were performed as previously described.

Net primary production (NPP), dark respiration (R), gross primary production (GPP), and light and dark calcification (G) rates were

corrected from controls and calculated as Equations (1), (2), and (3), respectively:

$$\text{NPP (or R)} = \frac{\Delta\text{O}_2 \times V}{\Delta t \times \text{DW}} \tag{1}$$

$$\text{GPP} = \text{NPP} + \text{R} \tag{2}$$

$$\text{G} = -\frac{\Delta\text{T}_A \times V}{2 \times \Delta t \times \text{DW}} \tag{3}$$

The ammonium flux was calculated according to the following equation:

$$\text{NH}_4^+ = \frac{\Delta\text{NH}_4^+ \times V}{\Delta t \times \text{DW}} \tag{4}$$

where ΔO<sub>2</sub> and ΔT<sub>A</sub> are respectively the differences between initial and final O<sub>2</sub> concentrations (µmol O<sub>2</sub> L<sup>-1</sup>) and T<sub>A</sub> (µEq/L), V is the volume of the chamber (L), Δt is the incubation time (hr), and DW is the dry weight of the algae (g).

In the absence of inhibition of the net primary production and calcification by high irradiances, NPP and G versus irradiance (E, µmol photons m<sup>-2</sup> s<sup>-1</sup>) curve parameters were obtained according to Platt, Gallegos, and Harrison (1980):

$$\text{NPP} = \text{GPP}_{\text{max}} \times \left(1 - e^{-\frac{E}{E_k}}\right) - \text{R} \tag{5}$$

$$\text{G} = \text{G}_{\text{max}} \times \left(1 - e^{-\frac{E}{E_k}}\right) - \text{G}_D \tag{6}$$

In the presence of inhibition of the net primary production and calcification by high irradiances, NPP-E and G-E curves were established by fitting Eilers and Peeters (1988) equation:

$$\text{NPP} = \frac{I}{I^2 \times a + I \times b + c} - \text{R} \tag{7}$$

$$\text{G} = \frac{I}{I^2 \times a + I \times b + c} - \text{G}_D \tag{8}$$

in Equations (5) and (7), R is the dark respiration rate; in Equations (6) and (8), G<sub>D</sub> is the calcification rate in the dark. GPP<sub>max</sub> and G<sub>max</sub> are the maximum rates of gross primary production and calcification (µmol O<sub>2</sub> or CaCO<sub>3</sub> g DW hr<sup>-1</sup>), respectively, and E<sub>k</sub> (µmol photons m<sup>-2</sup> s<sup>-1</sup>) is the saturating irradiance.

In the presence of inhibition of the net primary production and calcification by high irradiances GPP<sub>max</sub>, G<sub>max</sub>, and E<sub>k</sub> were calculated from the parameters a, b, and c in Equations (7) and (8) as:

$$\text{GPP}_{\text{max}} \text{ or } \text{G}_{\text{max}} = \frac{1}{b + 2\sqrt{ac}} \tag{9}$$

$$\text{E}_k = \frac{c}{b + 2\sqrt{ac}} \tag{10}$$



**TABLE 1** Mean values of temperature and carbonate system parameters and nutrient concentrations in each treatment (present (Pr) and future (Fu) scenarios with low (LN) or high nutrients (HN)) in both seasons

Treatment	T (°C)	pH <sub>T</sub>	T <sub>A</sub> (μmol/kg SW)	DIC (μmol/kg SW)	pCO <sub>2</sub> (μatm)	Ω <sub>A</sub>	PO <sub>4</sub> <sup>3-</sup> (μmol/L)	NO <sub>3</sub> <sup>-</sup> (μmol/L)	NH <sub>4</sub> <sup>+</sup> (μmol/L)
Winter									
Pr-LN	10.0 ± 0.1	8.04 ± 0.01	2,402 ± 18	2,213 ± 15	418 ± 4	2.14 ± 0.04	0.2–0.4	4.0–10.0	0.3–1.3
Pr-HN	10.0 ± 0.1	8.04 ± 0.01	2,399 ± 15	2,209 ± 9	420 ± 8	2.10 ± 0.03	0.8–1.2	30.0–50.0	0.3–3.1
Fu-LN	12.7 ± 0.2	7.71 ± 0.01	2,372 ± 16	2,298 ± 14	965 ± 9	1.16 ± 0.04	0.2–0.4	4.0–10.0	0.3–1.3
Fu-HN	12.7 ± 0.2	7.71 ± 0.01	2,395 ± 24	2,318 ± 22	965 ± 10	1.14 ± 0.04	0.8–1.2	30.0–50.0	0.3–3.1
Summer									
Pr-LN	18.0 ± 0.1	8.00 ± 0.01	2,375 ± 10	2,141 ± 11	450 ± 10	2.64 ± 0.02	0.3–0.4	3.2–6.4	0.2–0.5
Pr-HN	18.0 ± 0.1	8.00 ± 0.01	2,351 ± 9	2,126 ± 20	464 ± 10	2.53 ± 0.08	0.9–1.7	25.0–55.0	0.2–0.5
Fu-LN	20.7 ± 0.2	7.67 ± 0.01	2,414 ± 12	2,323 ± 12	1,187 ± 20	1.39 ± 0.03	0.3–0.4	3.2–6.4	0.2–0.5
Fu-HN	20.7 ± 0.2	7.67 ± 0.01	2,424 ± 7	2,310 ± 16	1,182 ± 36	1.45 ± 0.04	0.9–1.7	25.0–55.0	0.2–0.5

Note: Temperature and pH<sub>T</sub> were monitored every day in each aquarium (n = 90). Total alkalinity (T<sub>A</sub>) was measured each week (n = 20). Nutrients (PO<sub>4</sub><sup>3-</sup>, NO<sub>3</sub><sup>-</sup> and NH<sub>4</sub><sup>+</sup>) were measured twice per month (n = 7). Dissolved inorganic carbon (DIC), pCO<sub>2</sub>, and Ω<sub>A</sub> were calculated from temperature, pH<sub>T</sub>, T<sub>A</sub>, and salinity (35) using the CO<sub>2</sub>sys software. Abbreviation: SW, seawater.

## 2.6 | Dry weight and CaCO<sub>3</sub> content in algae

After incubations, DW was measured on lyophilized maerl samples. The relative CaCO<sub>3</sub> content (%) was calculated from the ash weight after burning at 550°C (5 hr) and the DW of samples (g CaCO<sub>3</sub> g<sup>-1</sup> DW maerl).

## 2.7 | Chlorophyll a content

Maerl samples for chlorophyll *a* analyses were stored at -80°C prior to lyophilization. Afterward, they were ground in plastic tubes with 0.5 cm stainless steel beads (Brammer) using a Tissue Lyser II (QIAGEN). Extraction was done according to Arar and Collins (1997), that is, 5 ml of 90% acetone were added to 0.05 g of maerl powder. Samples were kept in glass tubes for 12 hr in dark and 4°C. Afterward, incubation tubes were centrifuged at 3,000 g for 10 min, and the supernatant was then transferred to a new tube; fluorescence was then measured using a calibrated Turner 10-AU fluorometer.

## 2.8 | Statistics

Statistical analyses were performed using the open source software R version 3.5.1 (R Core Team, 2017). The chlorophyll *a* and CaCO<sub>3</sub> contents, and the metabolic rates were averaged for the two sets of thalli of each maerl species per aquarium, and the individual aquaria were thus considered as replicates (n = 3). Because of the small number of replicates per treatment, the normality of data was not verified for any of the analyses. This prevented us from using parametric analyses such as ANOVA or PERMANOVA and led us to use nonparametric analyses. Moreover, the use of rank-based tests has been recommended for small samples (Legendre & Legendre, 1998) and is often as powerful as parametric tests (Scherrer, 2007). However, we are aware that such an approach increases the number of comparisons, and as such, there is a risk of a type I error, that is, incorrect rejection of the null hypothesis.

A two-way nonparametric ANOVA (the Scheirer-Ray-Hare (SRH) test) was then performed to test the effects of the temperature–pH scenarios, nutrient availability, and their interaction on chlorophyll *a* and CaCO<sub>3</sub> content, and primary production, respiration, and calcification rates under ambient irradiance and in the dark. NPP-E and G-E curve parameter fits were tested by the Fisher test using the following R script:  $p\text{-value} = 1 - pf(F, r, n)$ , where *F* is the Fisher test, *r* is the number of estimated parameters, and *n* is the number of points used to adjust the curve.

In both seasons, a nonparametric Kruskal–Wallis (KW) test was used to test differences in NPP-E and G-E curve parameters between present and future scenarios (Pr-LN and Fu-LN). For summer conditions, a two-way nonparametric ANOVA (SRH test) was done to test the effects of the temperature–pH scenarios, nutrient availability, and their interaction on *L. corallioides* P-E and G-E curve parameters.

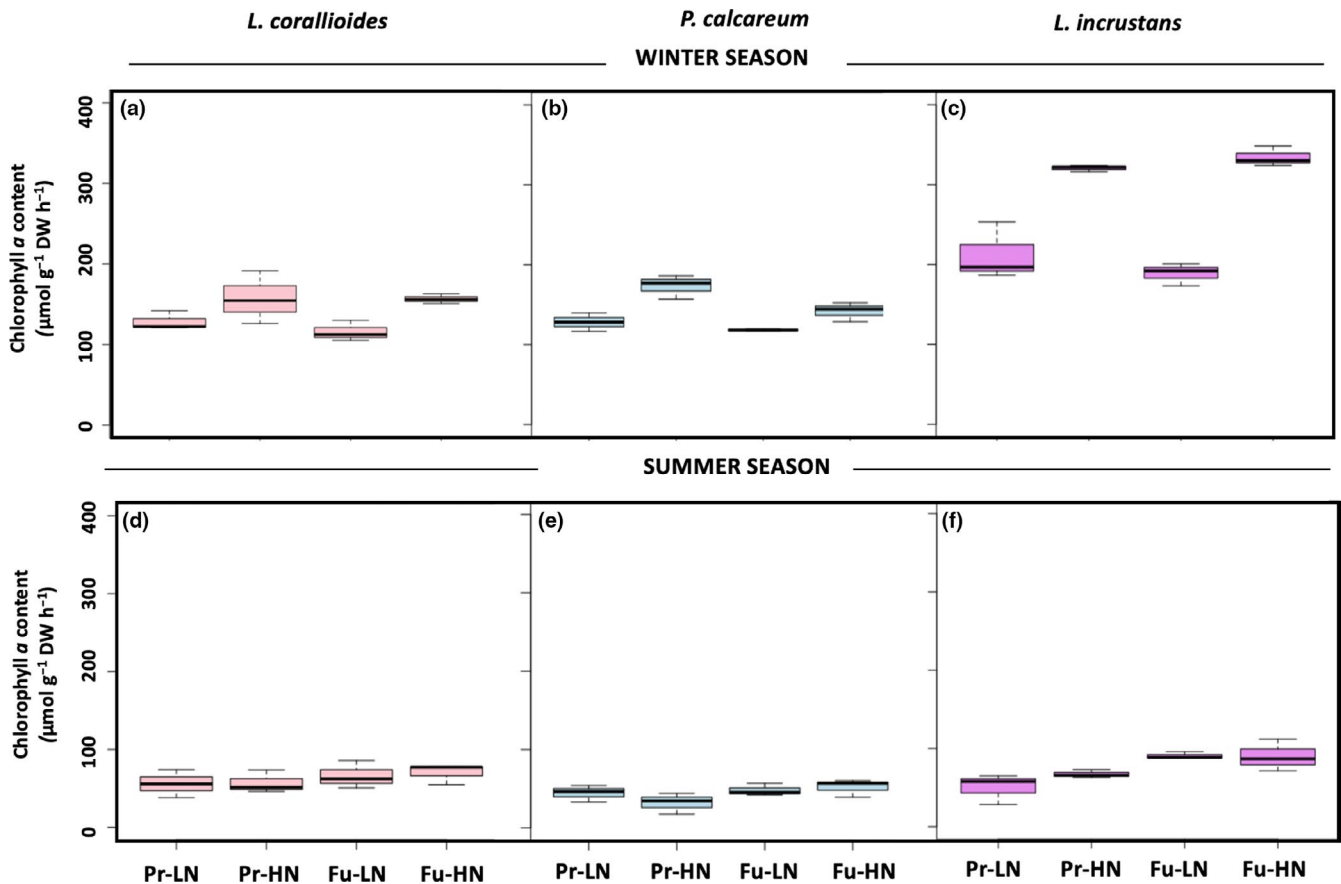

**FIGURE 3** Box plots of the chlorophyll *a* content in *Lithothamnion corallioides*, *Phymatolithon calcareum*, and *Lithophyllum incrustans* in winter (a, b, c) and in summer (d, e, f) ( $n = 3$ ) in the present (Pr) and future (Fu) scenarios with low (LN) or high nutrients (HN). Boxes extend from the 25th to the 75th percentiles of all the data for each treatment; the central horizontal line represents the median, and bars extend to the 95% confidence limits

### 3 | RESULTS

#### 3.1 | Physicochemical parameters

Salinity remained stable in both seasons at  $35.0 \pm 0.2$ . Mean values of seawater temperature,  $\text{pH}_T$ ,  $T_A$ , DIC,  $\text{pCO}_2$ , and  $\Omega_{Ar}$  and mean nutrient concentrations for the four treatments and both seasons are given in Table 1.

#### 3.2 | Impact of the future temperature–pH scenario and nutrient enrichment in winter conditions under ambient irradiance

Chl *a* content was significantly and positively affected by nutrient enrichment in the three maerl species (Appendix S1 & Figure 3a–c).  $\text{CaCO}_3$  content was not significantly affected by any treatment in none of the species (Appendix S1). Mean values were  $85.3 \pm 0.0\%$  in *L. corallioides*,  $85.7 \pm 0.0\%$  in *P. calcareum*, and  $83.8 \pm 0.0\%$  in *L. incrustans*.

*R* rates in *L. corallioides* and *L. incrustans* were not significantly affected by the temperature–pH scenario or nutrient conditions

(Table 2 and Figure 4a,c). *R* rates in *P. calcareum* were negatively affected by nutrient enrichment (Table 2 and Figure 4b). GPP rates did not vary significantly across treatments or species (Table 2 and Figure 5c).  $G_L$  rates did not differ significantly between treatments in *L. corallioides*, although they were more than two-fold lower under Fu-LN relative to the other treatments (Table 2 and Figure 6a). *P. calcareum* showed net dissolution under Fu-LN, but the test did not reveal any significant differences (Table 2 and Figure 6b). In *L. incrustans*,  $G_L$  rates were significantly affected by the temperature–pH scenario with net dissolution observed under Fu-LN.

*Lithothamnion corallioides* and *P. calcareum* winter  $G_D$  rates were negatively affected by the future temperature–pH scenario (Table 2), and net dissolution was observed under Fu-LN (Figure 7a,b). *Lithophyllum incrustans*  $G_D$  rates did not differ significantly between treatments (Table 2), although dissolution was observed under Fu-LN (Figure 7c).

$G_L$ :GPP ratio did not vary significantly between treatments in *L. corallioides* ( $0.23 \pm 0.11$ ) and *P. calcareum* ( $0.09 \pm 0.19$ ) (Table 2). In *L. incrustans*, it ranged from  $-0.03 \pm 0.10$  (Fu-LN) to  $0.33 \pm 0.00$  (Pr-HN) and was negatively affected by the future temperature–pH scenario (Table 2).

**TABLE 2** Summary of the results of two-way nonparametric (Scheirer-Ray-Hare) tests testing the effects of temperature and pH scenarios, nutrient enrichment and their interaction on *Lithothamnion corallioides*, *Phymatolithon calcareum*, *Lithophyllum incrustans* gross primary production (GPP), respiration (R), light ( $G_L$ ) and dark calcification ( $G_D$ ) rates, and  $G_L$ :GPP ratio in winter and summer conditions ( $n = 3$ )

df	Gross primary production (GPP) ( $\mu\text{mol O}_2 \text{ g}^{-1} \text{ DW hr}^{-1}$ )		Respiration (R) ( $\mu\text{mol O}_2 \text{ g}^{-1} \text{ DW hr}^{-1}$ )		Calcification in the light ( $G_L$ ) ( $\mu\text{mol CaCO}_3 \text{ g}^{-1} \text{ DW hr}^{-1}$ )		Calcification in the dark ( $G_D$ ) ( $\mu\text{mol CaCO}_3 \text{ g}^{-1} \text{ DW hr}^{-1}$ )		$G_L$ :GPP ratio	
	F	p-value	F	p-value	F	p-value	F	p-value	F	p-value
<i>Lithothamnion corallioides</i> /WINTER										
Scenario	1	0.02	.873	.337	2.56	.109	8.31	.004**	0.92	.337
Nutrients	1	0.41	.522	.200	2.56	.109	0.92	.337	2.08	.149
Interaction	1	0.92	.337	.149	1.26	.262	0.23	.631	2.56	.109
<i>Phymatolithon calcareum</i> /WINTER										
Scenario	1	3.10	.078	.337	2.08	.149	5.77	.016*	2.56	.109
Nutrients	1	0.00	1.000	.025*	3.10	.078	0.23	.631	2.08	.149
Interaction	1	2.56	.109	.631	1.26	.262	2.08	.149	1.64	.200
<i>Lithophyllum incrustans</i> /WINTER										
Scenario	1	1.26	.262	.337	6.56	.010*	0.03	.873	6.56	.010*
Nutrients	1	3.69	.055	.149	1.26	.262	2.56	.109	1.64	.200
Interaction	1	1.64	.200	.055	0.41	.522	2.56	.109	0.23	.631
<i>Lithothamnion corallioides</i> /SUMMER										
Scenario	1	0.92	.337	.055	1.26	.262	2.08	.149	1.64	.200
Nutrients	1	0.41	.522	.262	3.69	.055	0.03	.873	3.69	.055
Interaction	1	4.33	.037*	.200	1.64	.200	3.10	.078	0.64	.423
<i>Phymatolithon calcareum</i> /SUMMER										
Scenario	1	1.26	.262	.016*	1.26	.262	6.56	.010*	0.03	.873
Nutrients	1	4.33	.037*	.149	0.23	.631	0.00	1.000	0.23	.631
Interaction	1	0.03	.872	.631	7.41	.006**	3.10	.078	7.41	.006**
<i>Lithophyllum incrustans</i> /SUMMER										
Scenario	1	4.33	.037*	.149	3.69	.055	0.02	.873	6.56	.010*
Nutrient	1	0.64	.423	.631	0.64	.423	6.56	.010*	0.03	.873
Interaction	1	0.64	.423	.016*	0.10	.749	0.10	.749	0.00	1.000
<i>Lithothamnion corallioides</i>										
Season	1	4.81	.028*	.043*	12.81	<.001***	0.96	.326	8.67	.003**
<i>Phymatolithon calcareum</i>										
Season	1	14.52	<.001***	.050	0.16	.686	0.01	.908	4.81	.028*
<i>Lithophyllum incrustans</i>										
Season	1	2.43	.119	<.001***	17.28	<.001***	12.40	.001**	0.48	.488

Note: Comparisons among seasons were done using a one-way nonparametric (Kruskal-Wallis) test. Analyses significant at the  $\alpha = .025$  level are indicated by asterisks. Values in bold refer to parameters that are significantly different.



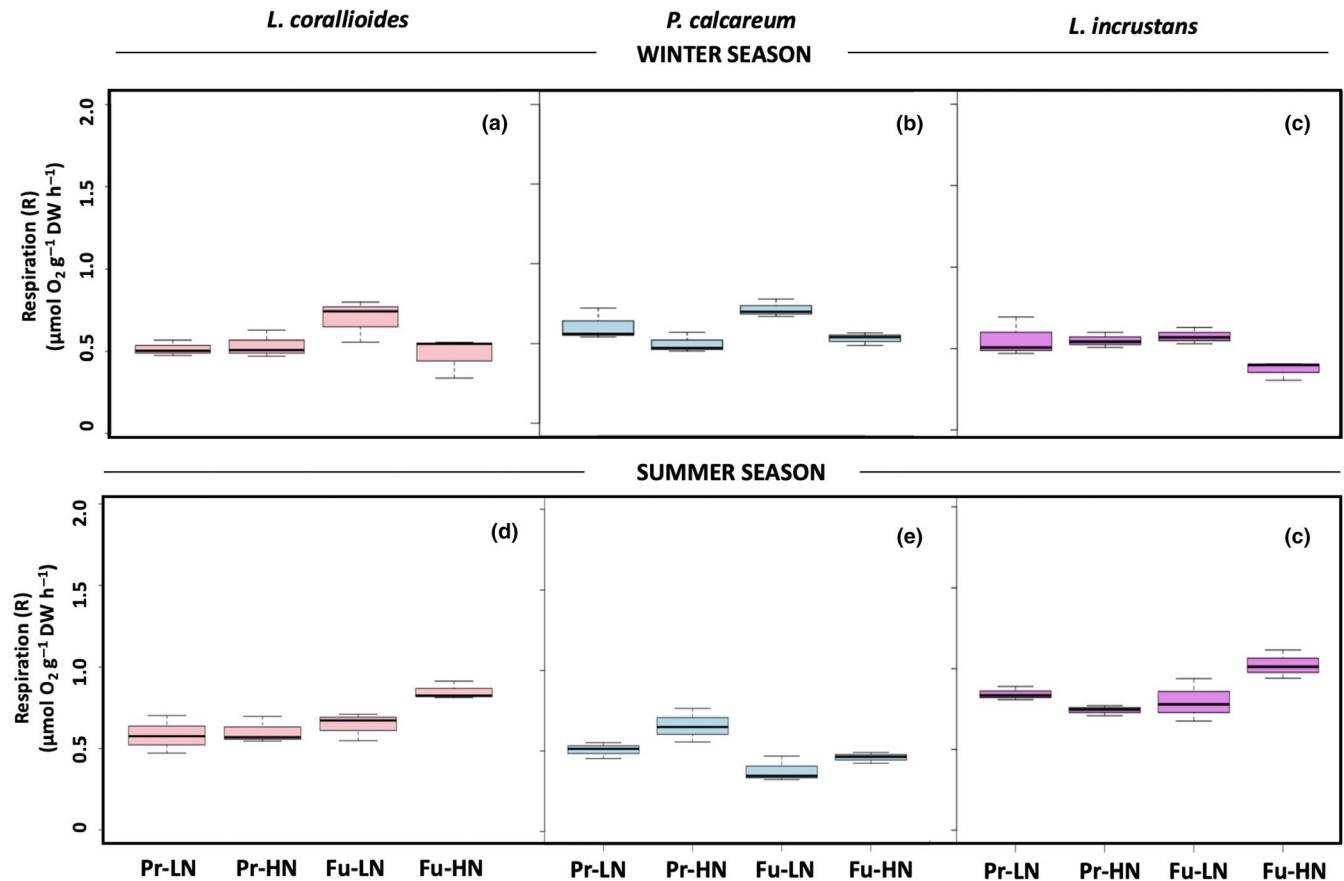

**FIGURE 4** Box plots presenting respiration rates of *Lithothamnion corallioides*, *Phymatolithon calcareum*, and *Lithophyllum incrustans* in the winter (a, b, c) and in the summer (d, e, f) ( $n = 3$ ) in the present (Pr) and future (Fu) scenarios with low (LN) or high nutrients (HN). Boxes extend from the 25th to the 75th percentiles of all the data for each treatment; the central horizontal line represents the median, and bars extend to the 95% confidence limits

### 3.3 | Impact of the future temperature–pH scenario and nutrient enrichment in summer conditions under ambient irradiance

*Lithothamnion corallioides* and *P. calcareum* Chl *a* content was affected neither by the temperature–pH scenario nor by nutrient conditions (Figure 3d,e) but, in *L. incrustans*, Chl *a* was positively affected by the future temperature–pH scenario (Appendix S1 & Figure 3f).  $\text{CaCO}_3$  content ranged from 84.6 (Fu-LN) to 86.4% (Pr-LN) in *L. corallioides* with significant lower values under the future temperature–pH scenarios. In *P. calcareum*, it ranged from 85.0% (Pr-LN) to 86.5% (Fu-LN) and was affected by the interaction between scenario and nutrients. It was not significantly affected by any treatment in *L. incrustans* and averaged  $84.4 \pm 0.0\%$ .

*Lithothamnion corallioides* *R* rates were not affected by any treatment; in *P. calcareum*, *R* was negatively affected by the temperature–pH scenario. In *L. incrustans*, *R* rates were significantly affected by the interaction between the temperature–pH scenario and nutrient availability (Table 2 & Figure 4d–f). GPP of *L. corallioides* was also affected by the interaction between the temperature–pH scenario and nutrient availability (Table 2 & Figure 5d). GPP rates increased with nutrient enrichment in *P. calcareum* (Table 2 & Figure 5e) and

with the future temperature–pH scenario in *L. incrustans* (Table 2 & Figure 5f). None of the species observed dissolution in the light in the summer. *Lithothamnion corallioides*  $G_L$  was not significantly affected by any of the treatments, although the  $G_L$  rate was 39% lower under Fu-LN than under Fu-HN (Table 2 & Figure 6d). In *P. calcareum*,  $G_L$  was affected by the interaction between the temperature–pH scenarios and nutrient availability (Table 2 & Figure 6e): when nutrients were added, it increased under the present scenario and decreased under the future scenario. In *L. incrustans*,  $G_L$  rates were affected neither by the temperature–pH scenario nor by nutrient enrichment (Table 2 & Figure 6f). Calcification was observed in the dark in *L. corallioides* under all treatments, and no effect was observed (Table 2 & Figure 7d). As in winter conditions, *P. calcareum*  $G_D$  rates were negatively affected by the temperature–pH scenario (Table 2) with net dissolution observed under Fu-HN (Figure 7e). *Lithophyllum incrustans*  $G_D$  was significantly affected by nutrient availability (Table 2): It was higher under HN conditions than LN conditions (Figure 7f).

The *L. corallioides*  $G_L$ :GPP ratio did not differ significantly between treatments and was on average of  $0.35 \pm 0.06$ . The *P. calcareum* summer  $G_L$ :GPP ratio ranged from  $0.13 \pm 0.02$  (Fu-HN) to  $0.23 \pm 0.05$  (Fu-LN) and was significantly affected by the interaction between

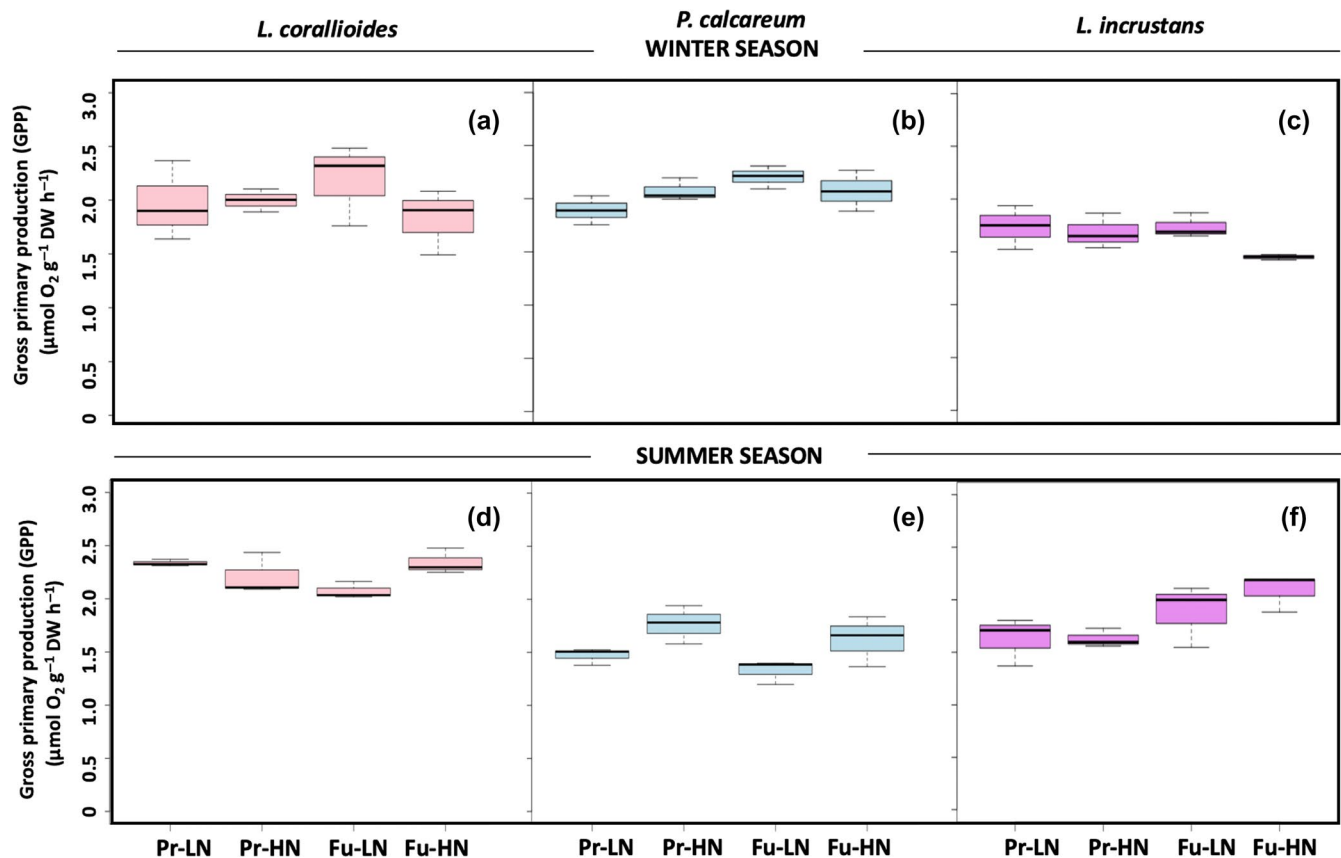

**FIGURE 5** Box plots presenting gross primary production rates of *Lithothamnion corallioides*, *Phymatolithon calcareum*, and *Lithophyllum incrustans* in the winter (a, b, c) and in the summer (d, e, f) ( $n = 3$ ) in the present (Pr) and future (Fu) scenarios with low (LN) or high nutrients (HN). Boxes extend from the 25th to the 75th percentiles of all the data for each treatment; the central horizontal line represents the median, and bars extend to the 95% confidence limits

the temperature–pH scenario and nutrient availability (Table 2). In *L. incrustans*, the summer  $G_L$ :GPP ratio was significantly lower under the future temperature–pH scenario (mean value of  $0.22 \pm 0.04$ ) than under present scenarios (mean value of  $0.34 \pm 0.06$ ).

### 3.4 | Impact of the future temperature–pH scenario on the relationship between net primary production/calcification and irradiance in winter conditions

The curves of the relationship between winter net primary production (NPP) or calcification (G) and irradiance (E) are shown on Figures 8 and 9 ( $R^2 > 0.90$ ).  $GPP_{max}$  increased significantly in the future temperature–pH scenario in *L. corallioides* and *P. calcareum*. Both species showed photoinhibition at this season at irradiances above  $200 \mu\text{mol photons m}^{-2} \text{s}^{-1}$  (Figure 8). Photosynthetic irradiance of saturation ( $E_k$ ) was enhanced under the future scenario in *L. corallioides* (Figure 8 & Table 3). In the three maerl species,  $G_{max}$  was enhanced under the future scenario (Figure 9, Tables 3 and 4). In *P. calcareum*, inhibition was observed at irradiances above  $200 \mu\text{mol photons/m}^2 \text{hr}^{-1}$  (Figure 10). Calcification  $E_k$  was only affected in *L. corallioides*, where it was higher under the future scenario (Figure 9; Tables 3 and 4).

### 3.5 | Impact of the future temperature–pH scenario on the relationship between net primary production/calcification and irradiance in summer conditions

The curves of the relationship between NPP or G and E are shown in Figures 10 and 11 ( $R^2 > 0.90$ ). Only *L. corallioides*  $GPP_{max}$  increased significantly under the future scenario (Tables 3 and 4). Photosynthetic irradiance of saturation ( $E_k$ ) did not vary significantly among treatments in any of the species (Figure 10 & Table 4). *Lithothamnion corallioides*  $G_{max}$  dropped significantly (of 37%) under the future scenario, but did not vary significantly between temperature–pH scenarios in the other species (Figure 11; Tables 3 and 4). Calcification irradiance of saturation ( $E_k$ ) did not vary among treatments in any of the species (Figure 11; Tables 3 and 4).

### 3.6 | NH<sub>4</sub><sup>+</sup> consumption

NH<sub>4</sub><sup>+</sup> consumption did not vary significantly between species and treatments whatever the season (ANOVA,  $p > .05$ ), but winter consumption was significantly affected by irradiance (ANOVA,  $F = 96.06$ ,  $p < .001$ ). The highest value was observed at  $400 \mu\text{mol photons m}^{-2} \text{s}^{-1}$  ( $0.06 \pm 0.02 \mu\text{mol NH}_4^+ \text{g}^{-1} \text{DW hr}^{-1}$ ) and the lowest at

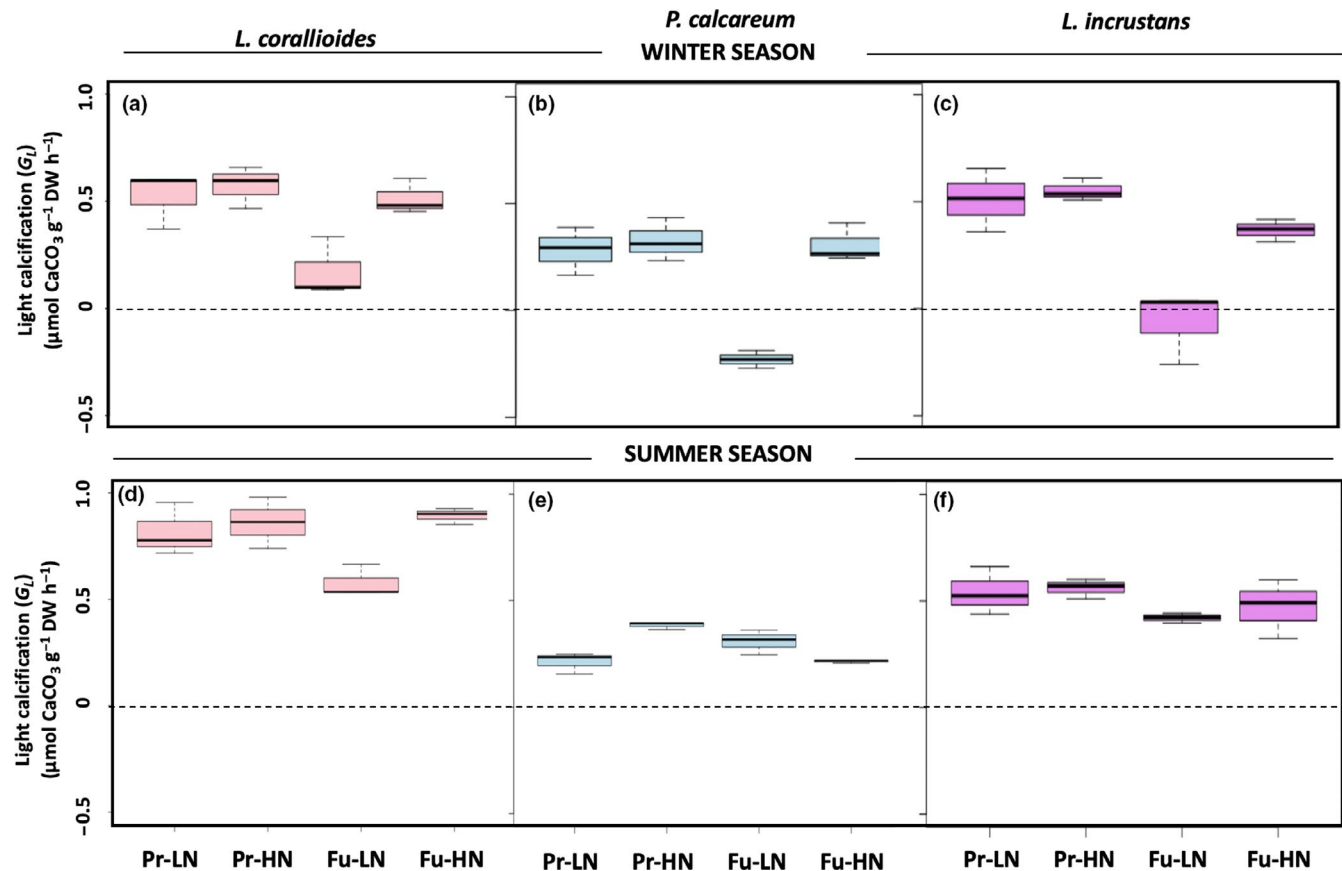

**FIGURE 6** Box plots presenting net calcification rates in the light ( $G_L$ ) of *Lithothamnion corallioides*, *Phymatolithon calcareum*, and *Lithophyllum incrustans* in the winter (a, b, c) and in the summer (d, e, f) ( $n = 3$ ) in the present (Pr) and future (Fu) scenarios with low (LN) or high nutrients (HN). Boxes extend from the 25th to the 75th percentiles of all the data for each treatment; the central horizontal line represents the median, and bars extend to the 95% confidence limits

$30 \mu\text{mol photons m}^{-2} \text{s}^{-1}$  ( $0.006 \pm 0.01 \mu\text{mol NH}_4^+ \text{g}^{-1} \text{DW s}^{-1}$ ). The  $\text{NH}_4^+$  summer consumption did not vary with irradiance (ANOVA,  $p > .05$ ), but was higher ( $0.07 \pm 0.02 \mu\text{mol g}^{-1} \text{DW s}^{-1}$ ) than in winter (ANOVA,  $p < .001$ ).

## 4 | DISCUSSION

### 4.1 | Effect of projected global climate change on physiological parameters

The response of the three studied maerl species to future pH and temperature scenarios varied with the season. This is in agreement with previous studies on coralline algae reporting that the effects of ocean warming and acidification are modified by seasonal variation in species responses and environmental conditions (Martin, Coahu, et al., 2013; Martin & Hall-Spencer, 2017). In temperate ecosystems, maerl beds face strong seasonal variability of physicochemical parameters (Qui-Minet et al., 2018) including variations in temperature and irradiance (length of photoperiod and intensity). Rising sea temperature can be beneficial in winter for coralline algae, allowing an increase in their photosynthetic and calcification rates (Martin, Coahu, et al., 2013). However, increased temperature in summer above the

range of temperatures experienced in natural habitats could be detrimental for coralline algae; moreover, as it could be aggravated by decreased pH (Martin & Gattuso, 2009). In addition, illumination factors such as length of photoperiod and intensity affect the physiology of coralline algae (Martin, Castets, & Clavier, 2006; Martin, Charnoz, et al., 2013; Martin et al., 2007; Martin, Coahu, et al., 2013). The length of the photoperiod directly influences diel patterns of respiration and net photosynthesis and their coupling to calcification. In the light, the photosynthetic fixation of  $\text{CO}_2$  causes an increase in the pH within the intracellular spaces and at the boundary layer of diffusion that induces  $\text{CaCO}_3$  precipitation (Cornwall, Hepburn, Pilditch, & Hurd, 2013; De Beer & Larkum, 2001). Conversely, in the dark, the respiration process generates  $\text{CO}_2$ , resulting in a decrease of pH within the intracellular spaces and the boundary layer of diffusion (Cornwall et al., 2013; Hurd, Harrison, Bischof, & Lobban, 2014) and thus hindering calcification.

In future climate change scenarios, the three maerl species may thus be particularly sensitive during the winter period when photoperiod is short. Indeed, under this scenario, calcification rates in winter significantly decreased in *L. incrustans*, while dissolution was observed in *P. calcareum* under ambient irradiance ( $30 \mu\text{mol photons m}^{-2} \text{s}^{-1}$ ). By contrast, the lack of effect of the future scenario in summer under ambient irradiance suggests a positive effect of long

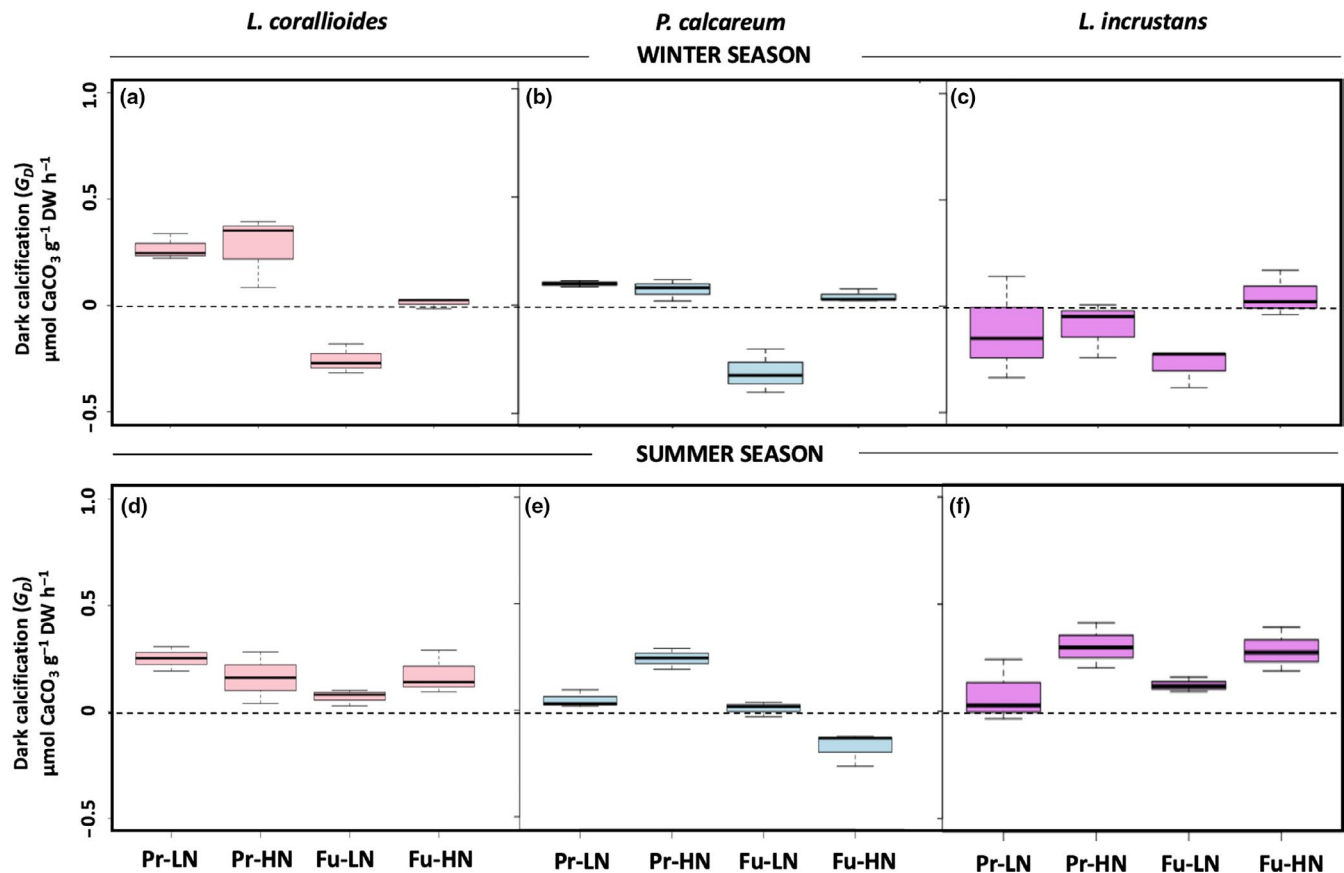

**FIGURE 7** Boxes presenting net calcification in the dark ( $G_D$ ) of *Lithothamnion corallioides*, *Phymatolithon calcareum*, and *Lithophyllum incrustans* in the winter (a, b, c) and in the summer (d, e, f) ( $n = 3$ ) in the present (Pr) and future (Fu) scenarios with low (LN) or high nutrients (HN). Boxes extend from the 25th to the 75th percentiles of all the data for each treatment; the central horizontal line represents the median, and bars extend to the 95% confidence limits

photoperiods and the ability of the three species to cope with lower values of pH under elevated temperatures.

Light intensity has an important role in the response of coral-line algae to climate change. For example, in winter, maximum rates of gross primary production under high irradiances were enhanced under the future scenario in *L. corallioides* and *P. calcareum*, while the rates of gross primary production under ambient irradiances were unaffected. This may reflect the absence of dissolved inorganic carbon (DIC) limitation under ambient irradiance in comparison with higher irradiances. It is thus of particular importance to determine photosynthetic rates as a function of irradiance since light availability can affect the ability of algae to use DIC. For example, DIC limitation can be influenced by irradiance as carbon concentrating mechanisms are energy dependent (Raven, Giordano, Beardall, & Maberly, 2012).

Mechanisms that control light harvesting and photoprotection depend on light intensity while they may be controlled by temperature and pH variations (Croce & Van Amerongen, 2014). Therefore, due to seasonal changes in irradiance, the outcome of light intensity interaction with global climate change will directly depend on the season. *Lithothamnion corallioides* and *P. calcareum* presented a certain degree of inhibition of *net primary production* and *net calcification*

under high irradiances, while no photoinhibition was observed for *L. incrustans*. The maerl species *L. corallioides* and *P. calcareum* possess zeaxanthin as a photoprotective pigment, whereas *L. incrustans* possess lutein as a photoprotective pigment and has a significantly higher concentration of pigments relative to the other species (Qui-Minet et al., 2018). Therefore, although the three studied maerl species can be found at the same location in our study site, they have different geographical distribution, reflecting different ecological affinities. Indeed, the response to the future climate change scenario of maerl is here dependent on the species. Species-specific responses to global climate change under different irradiances may result from differences in morphology and taxonomical groups, that may be translated in differences in light reflectance, type, and concentration of photoprotective pigments (Burdett et al., 2014; Vazquez-Elizondo & Enriquez, 2016).

In this work, we studied how the combination of ocean acidification and warming impacted the photosynthetic and calcification response of maerl species to different irradiances. Maximum rates of gross primary production and calcification rates are known to increase with increasing temperature up to a thermal optimum and then decline steeply with further increase in temperature (Chalker & Taylor, 1975; Eilers & Peeters, 1988; Hurd et al., 2014; Marshall

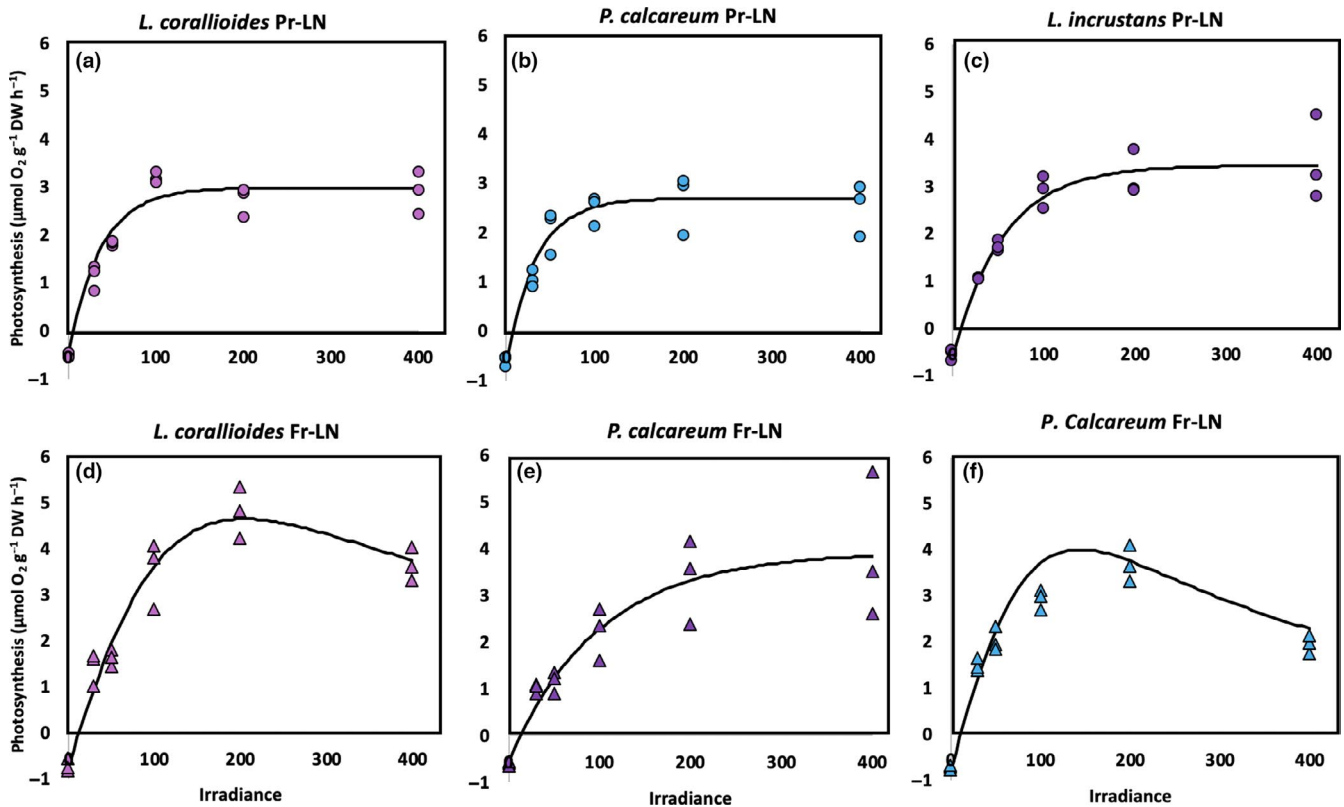

**FIGURE 8** Relationship between net primary production rates and irradiance in *Lithothamnion corallioides*, *Phymatolithon calcareum*, and *Lithophyllum incrustans* under unenriched (LN) conditions in the present temperature–pH scenario (Pr-LN, a, b, c, respectively) and in the future temperature–pH scenario (Fu-LN, d, e, f, respectively) in winter conditions

& Clode, 2002). Those parameters were not enhanced by the future summer scenario in the here studied maerl species, *L. corallioides*. Therefore, we assume that *P. calcareum* and *L. incrustans* photosynthetic and calcification rates may decline with further rise in temperature. Furthermore, the significant decrease in the maximum rate of calcification under high irradiances in *L. corallioides*, and its significant lower  $\text{CaCO}_3$  content at this season under the future summer scenario suggests a significant decrease of  $\text{CaCO}_3$  precipitation at low tide at this season, when irradiances are  $>300 \mu\text{mol photons m}^{-2} \text{s}^{-1}$ .

Knowledge of the environmental conditions at the location where the species were collected is essential to understand how they may be impacted by global climate change. Likewise, the maerl bed (Roz bed located in the Bay of Brest), where the three maerl species were collected has a shallow depth (*chart datum* 0.7 m) and faces a high variability of light intensity resulting from cloud cover, turbidity, and tide variation. According to our results, the three maerl species will be more vulnerable to dissolution and/or their calcification rates will decrease in the near future during the winter season due to low light intensities ( $30 \mu\text{mol photons m}^{-2} \text{s}^{-1}$ ). Although, in the summer, the photo-period and light intensity may increase; summer epiphyte algal species show high coverage of the Roz maerl bed, which severely decreases the light intensity that maerl receives. However, in

this study, photosynthesis and calcification were not impacted negatively by none of the scenarios at low irradiances in the summer.

Species-specific consequences of ocean warming and acidification are also noticed for the respiration of the maerl species. The respiration rates of *L. corallioides* and *L. incrustans* were not affected by the future pH and temperature scenario either in winter or in summer, while those of *P. calcareum* decreased significantly under the future summer scenario. Compared to the two other maerl species, *P. calcareum* has a higher affinity for lower temperatures (Adey & McKibbin, 1970) and may be more sensitive to increased temperature in summer. The lack of effect of decreased pH and increased temperatures on respiration rates in *L. corallioides* and *L. incrustans* may point to an adaptation to the near future conditions of ocean acidification and warming due to the substantial seasonal and diel pH and temperature variability experienced in their natural environment in the Roz maerl bed (Qui-Minet et al., 2018) although this was not the case for *P. calcareum*, living in the same place.

Considering our experimental system, a tank effect due to potential contamination within a header tank (spread of a disease or pollution) cannot be completely discarded and would have biased the results due to the interdependence of replicates. Nevertheless, due to the high seawater renewal rate and frequency of cleaning of the

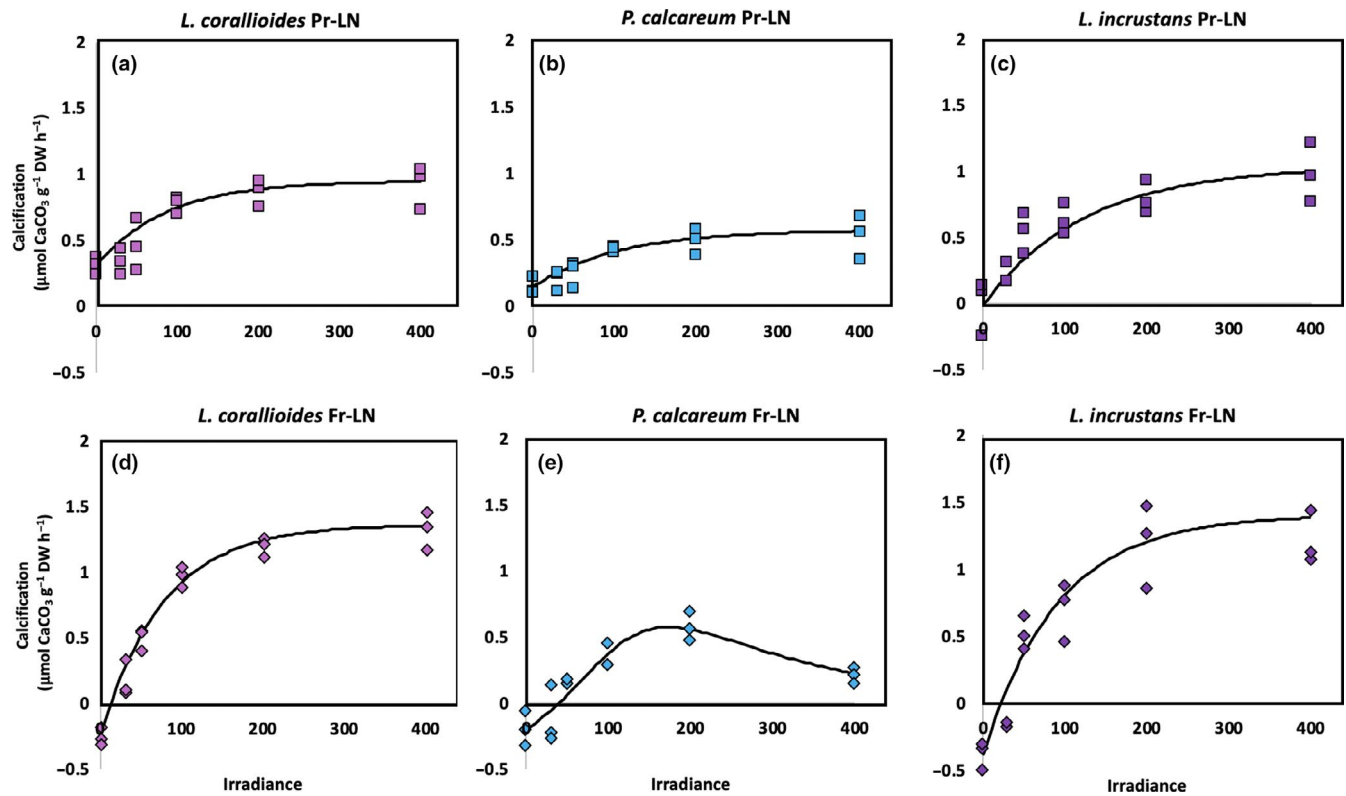

**FIGURE 9** Relationship between net calcification rates and irradiance in *Lithothamnion corallioides* under unenriched (LN) conditions in the present temperature–pH scenario (Pr-LN, a, b, c, respectively) and in the future temperature–pH scenario (Fu-LN, d, e, f, respectively) in winter conditions

**TABLE 3** Summary of the results of one-way nonparametric (Kruskal–Wallis) tests on the effects of temperature–pH scenarios under the unenriched nutrient conditions in *Lithothamnion corallioides*, *Phymatolithon calcareum*, *Lithophyllum incrustans* on the parameters of the relationships between primary production (NPP) or calcification (G) and irradiance (E) in winter and summer conditions ( $n = 3$ )

Species	df	Primary production				Calcification			
		GPP <sub>max</sub>		$E_k$		GPP <sub>max</sub>		$E_k$	
		F	p	F	p	F	p	F	p
<i>Lithothamnion corallioides</i> /WINTER	1	3.86	<b>.049*</b>	3.86	<b>.049*</b>	3.86	<b>.049*</b>	0.43	.513
<i>Phymatolithon calcareum</i> /WINTER	1	3.97	<b>.046*</b>	0.44	.507	3.86	<b>.049*</b>	0.05	.827
<i>Lithophyllum incrustans</i> /WINTER	1	0.05	.827	2.33	.127	3.86	<b>.049*</b>	0.43	.513
<i>Lithothamnion corallioides</i> /SUMMER	1	3.86	<b>.049*</b>	1.19	.275	3.86	<b>.049*</b>	3.86	<b>.049*</b>
<i>Phymatolithon calcareum</i> /SUMMER	1	0.43	.513	2.33	.127	0.05	.827	2.33	.127
<i>Lithophyllum incrustans</i> /SUMMER	1	2.33	.126	3.23	.072	0.43	.513	2.33	.127
<i>Lithothamnion corallioides</i> /SEASON	1	6.56	<b>.010*</b>	0.64	.423	0.92	.337	1.26	.262
<i>Phymatolithon calcareum</i> /SEASON	1	5.79	<b>.016*</b>	8.34	<b>.004**</b>	0.00	1.000	1.26	.262
<i>Lithophyllum incrustans</i> /SEASON	1	8.31	<b>.004**</b>	3.12	.077	3.10	.078	2.56	.109

Note: Comparison of the season effect on the parameters of the NPP–E and G–E curves was done using a nonparametric test (Kruskal–Wallis) ( $n = 3$ ). GPP<sub>max</sub>, the maximal gross primary production ( $\mu\text{mol O}_2 \text{g}^{-1} \text{DW hr}^{-1}$ ),  $E_k$ , the irradiance of saturation ( $\mu\text{mol photons m}^{-2} \text{s}^{-1}$ ),  $G_{\text{max}}$ , the maximal gross calcification ( $\mu\text{mol CaCO}_3 \text{g}^{-1} \text{DW hr}^{-1}$ ). Analyses significant at the  $\alpha = .025$  level are indicated by asterisks.

Values in bold refer to parameters that are significantly different.

header tanks, such a risk of contamination was limited. Furthermore, our results are in agreement with what has been observed in situ at the Bay of Brest, in terms of the primary production and calcification

seasonal tendency (Martin et al., 2006) and species-specific responses (Z. N. Qui-Minet, D. Davoult, J. Grall, C. Delaunay, C. Six, T. Cariou, S. Martin, unpublished).



**TABLE 4** Mean parameters of the relationship between net primary production (NPP) or calcification (G) rates and irradiance under the present temperature–pH scenario (Pr-LN) and future scenario (Fu-LN) under winter and summer conditions ( $n = 3$ )

Species	Net primary production ( $\mu\text{mol O}_2 \text{ g}^{-1} \text{ DW hr}^{-1}$ )		Calcification ( $\mu\text{mol CaCO}_3 \text{ g}^{-1} \text{ DW hr}^{-1}$ )	
	GPP <sub>max</sub>	$E_k$	G <sub>max</sub>	$E_k$
<i>Lithothamnion corallioides</i> /WINTER				
Pr-LN	3.5 ± 0.2	37 ± 11	0.64 ± 0.14	87 ± 40
Fu-LN	5.2 ± 0.7	99 ± 13	1.62 ± 0.16	77 ± 8
<i>Phymatolithon calcareum</i> /WINTER				
Pr-LN	3.3 ± 0.4	34 ± 14	0.43 ± 0.15	104 ± 35
Fu-LN	4.6 ± 0.0	47 ± 0	0.87 ± 0.16	133 ± 45
<i>Lithophyllum incrustans</i> /WINTER				
Pr-LN	4.0 ± 0.9	56 ± 16	1.05 ± 0.25	125 ± 90
Fu-LN	4.5 ± 1.8	99 ± 47	1.78 ± 0.41	91 ± 17
Pr-LN	5.7 ± 0.2	76 ± 14	1.6 ± 0.0	95 ± 27
<i>Lithothamnion corallioides</i> /SUMMER				
Pr-HN	7.7 ± 0.4	75 ± 12	1.3 ± 0.2	97 ± 70
Fu-LN	7.2 ± 1.0	105 ± 34	1.0 ± 0.1	46 ± 5
Fu-HN	7.1 ± 0.4	79 ± 6	1.2 ± 0.2	55 ± 10
<i>Phymatolithon calcareum</i> /SUMMER				
Pr-LN	5.6 ± 1.0	99 ± 20	0.65 ± 0.03	129 ± 63
Fu-LN	5.6 ± 0.2	81 ± 15	0.65 ± 0.13	71 ± 31
<i>Lithophyllum incrustans</i> /SUMMER				
Pr-LN	8.0 ± 0.2	120 ± 9	2.27 ± 1.30	122 ± 23
Fu-LN	7.6 ± 0.4	93 ± 16	2.28 ± 0.07	161 ± 23

Note: GPP<sub>max</sub>, the maximal gross primary production rates ( $\mu\text{mol O}_2 \text{ g}^{-1} \text{ DW hr}^{-1}$ ),  $E_k$ , the irradiance of saturation ( $\mu\text{mol photon m}^{-2} \text{ s}^{-1}$ ), G<sub>max</sub>, the maximal gross calcification rates ( $\mu\text{mol CaCO}_3 \text{ g}^{-1} \text{ DW hr}^{-1}$ ).

## 4.2 | Effect of nutrient enrichment on physiological parameters

Coastal ecosystems are impacted by local changes, nutrient enrichment being one of the most relevant (Aufdenkampe et al., 2011). Species-specific responses were observed. *Lithothamnion corallioides* was not impacted by nutrient availability under any treatment and season. The significant decrease of *P. calcareum* respiration resulting from nutrient enrichment under winter season may be a way to minimize carbon dioxide losses and promote calcification, although the former process was not significantly affected at this season. Interestingly, in the summer an increase of nutrient availability impacted positively the rates of calcification in the dark in *L. incrustans* and gross primary production under ambient light irradiance in *P. calcareum*.

The absence of negative effects of nutrient enrichment on calcification contradicts previous studies that have described phosphate as a crystal poison due to its negative impact on the calcification

rates of coralline algae (Bjork et al., 1995; Kinsey & Davies, 1979; Simkiss, 1964), even at the concentrations reported in the present study (1  $\mu\text{mol/L}$ ; Bjork et al., 1995).

Physical factors (e.g., light intensity, photoperiod, and temperature) influence nutrient uptake kinetics in macroalgae (Fogg, 1953; Harrison & Hurd, 2001; Hofmann, Straub, & Bischof, 2013; Hurd et al., 2014; Magnusson, Larsson, & Axelsson, 1996; Ravaglioli et al., 2017). A strong correlation between seawater N concentration, algal N content, and algal pigment content has been observed for temperate macroalgae (Gevaert et al., 2001; Davison, Jordan, Fegley, & Grobe, 2007; Chow, 2012; Bordeyne, Migné, & Davoult, 2016), including the maerl species studied here (Qui-Minet et al., 2018). The increase in Chl *a* content under nutrient-enriched conditions in winter suggests that the uptake of N was not saturated under the treatment without enrichment (Hurd et al., 2014). Thus, high nutrient concentrations in winter might have a positive impact on temperate coralline algae physiology. Conversely, the lack of a nutrient loading effect on the summer chlorophyll *a* content of the three maerl species may indicate that, during this season, maerl have higher nutrient requirements and therefore would not store N.

## 4.3 | Interaction between global climate change and local change on physiological parameters

Environmental variations of natural and anthropogenic origin, including nutrient availability, may increase coralline algae resilience or exacerbate their response to global climate change (Williamson et al., 2014). According to some authors, the response of calcified organisms to the future conditions of temperature and pH will directly depend on nutrient availability (Celis-Plá et al., 2015; Langdon & Atkinson, 2005). Nevertheless, its impact has not been previously studied in maerl/rhodolith species. Several authors reported a negative effect of phosphate on the calcification rates of coralline algae (Bjork et al., 1995; Kinsey & Davies, 1979; Simkiss, 1964). However, higher phosphate concentrations (1  $\mu\text{mol/L}$ ) did not decrease the calcification rates in any of the species under projected future temperature–pH conditions (winter and summer) at ambient irradiance and at dark.

Although nonsignificant, the mean calcification rates of *L. corallioides* under a projected future winter scenario under ambient irradiance were about 50% higher under nutrient-enriched conditions relative to unenriched conditions. Moreover, net calcification remains positive (precipitation > dissolution) for the three maerl species under nutrient-enriched conditions (under ambient irradiance and in dark); whereas, net dissolution is observed in both light and dark conditions under unenriched conditions. In summer, none of the species showed net dissolution independently of nutrient availability.

These results are consistent with previous observations on calcifying organisms suggesting that energy supply helps them to cope with higher  $p\text{CO}_2$  (Schoepf et al., 2013; Tanaka et al., 2013; Ramajo et al., 2016). Nevertheless, the ratio between the rates of  $G_L$  and gross primary production for *P. calcareum* decreased significantly under the

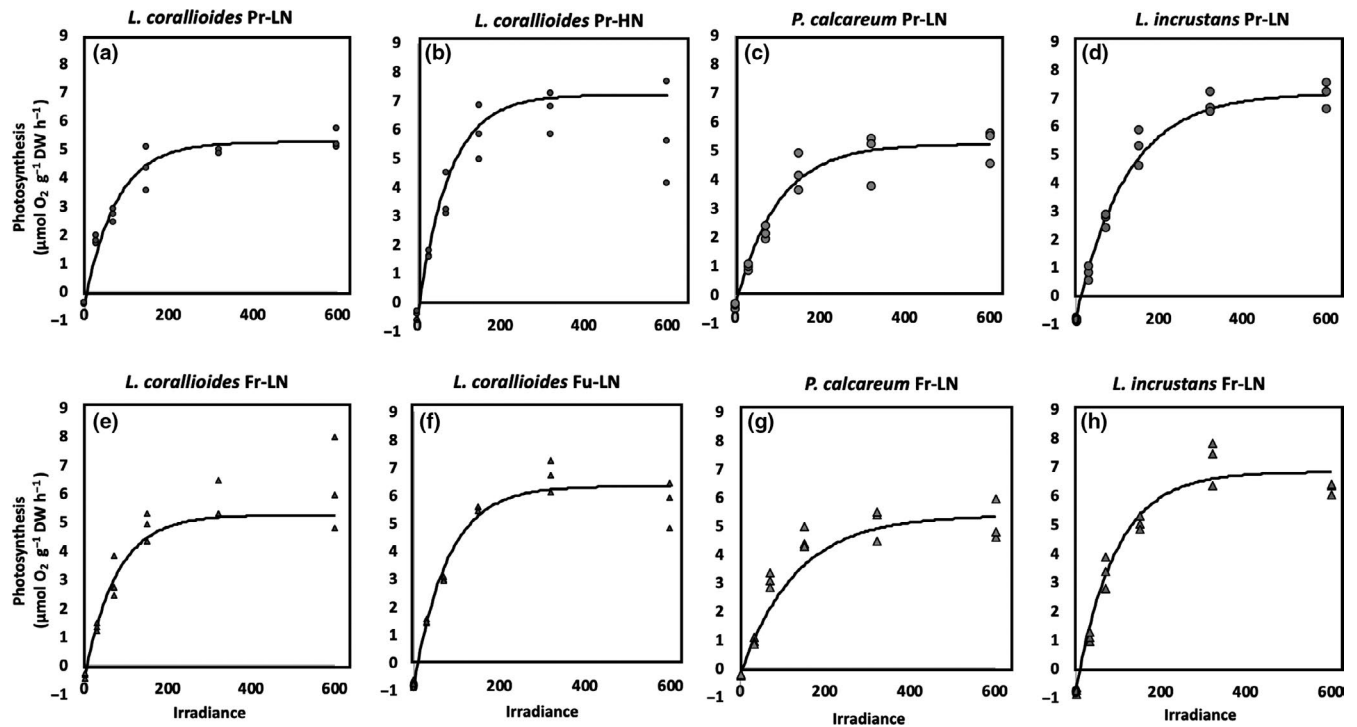

FIGURE 10 Relationship between net primary production rates and irradiance in *Lithothamnion corallioides* under unenriched (LN) and enriched conditions (HN), *Phymatolithon calcareum* and *Lithophyllum incrustans* under unenriched conditions in the present temperature–pH scenario (Pr, a, b, c, d, respectively) and in the future temperature–pH scenario (Fu, e, f, g, h, respectively) in summer conditions

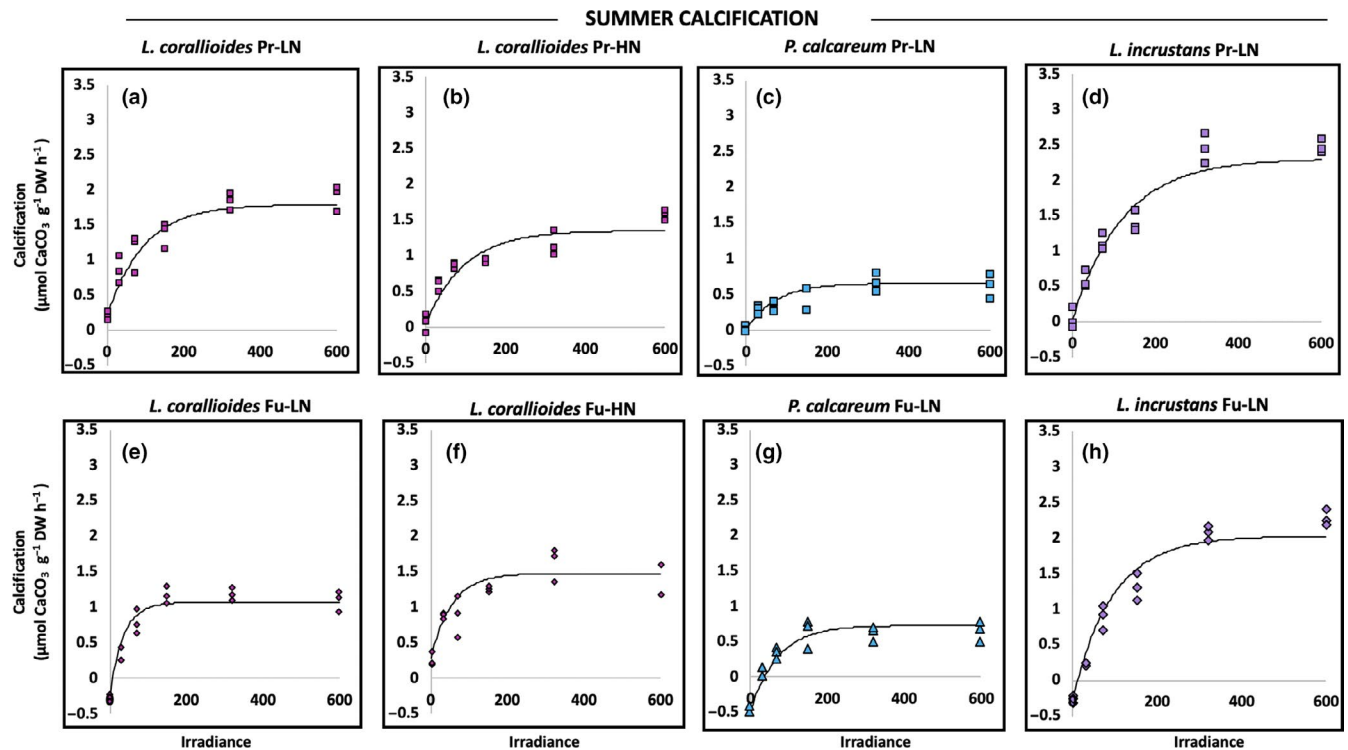

FIGURE 11 Relationship between net calcification rates and irradiance in *Lithothamnion corallioides* under unenriched (LN) and enriched conditions (HN), *Phymatolithon calcareum*, and *Lithophyllum incrustans* under unenriched (LN) conditions in the present temperature–pH scenario (Pr, a, b, c, d, respectively) and in the future temperature–pH scenario (Fu, e, f, g, h, respectively) in summer conditions

future pH/temperature scenario and nutrient-enriched conditions. Nutrient availability can modify the enzymatic activity of algae and therefore the energetic balance and the response of photosynthesis and calcification processes to elevated CO<sub>2</sub> and increased temperature (Hofmann et al., 2013; Williamson, Perkins, Voller, Yallop, & Brodie, 2017). However, to our knowledge, there is no information regarding the energy allocation of maerl in an ocean acidification and warming context.

Since pigments are N-containing components (Hurd et al., 2014), maerl specimens observing inhibition of winter gross primary production and net calcification under high irradiances were probably under deficient conditions of nitrogen.

The relationship between primary production/calcification and irradiance under different nutrient concentrations was studied only in *L. corallioides* in summer, and we did not observe any interactive effect between scenario and nutrients on the maximal rates of gross primary production and calcification (GPP<sub>max</sub> and G<sub>max</sub>). The nonresponsiveness to these conditions may suggest the nonlimitation of nutrients for this species, likely due to the capacity of macroalgae to stock N during previous seasons and to their low energetic requirements (Hurd et al., 2014). Further studies should consider the response and potential interaction between global climate change and nutrient loading on the light harvesting and calcification mechanisms of coralline algae, in order to give a deeper insight into their capacity to adapt to future scenarios. These results suggest that despite any possible artifact introduced by the experimental system, nutrient enrichment can modify the response of the algae under a given scenario.

## 5 | CONCLUSION

The magnitude of the ongoing global climate change effects on temperate maerl species located in coastal systems will depend on how their fitness responds to it in interaction with seasonal variations of temperature, photoperiod, light intensity, and nutrient availability, among other physicochemical parameters. It will also depend on the interaction with other stressors or sources of local changes, such as freshwater inputs, hydrodynamics, pollution, and among others (Horta et al., 2016; Qui-Minet et al., 2018).

Although care must be taken in the interpretation of the results due to potential pitfalls related to experimental design, our results suggest:

- An antagonistic interaction between global climate change and nutrient enrichment with nutrient loading ameliorating some of the negative effects of global climate change.
- The ability of ocean acidification and warming to impair light harvesting and photoprotective mechanisms of maerl algae, while this may depend on the interaction with other abiotic factors.
- Species-specific responses to global climate change suggest that dominance and species distribution may deeply change in the

future (Brodie et al., 2014). For instance, although species can adapt to the same environment, they are sensitive to specific thresholds of environmental parameters. Our study suggests that ocean acidification and warming would render some species more vulnerable to stressful conditions of irradiance than others. In this context, *P. calcareum* when living at shallow depths (thus, subject to higher light intensities) may be severely affected by global climate change relative to shallow adapted species such *L. incrustans*. *P. calcareum* is also the species with the lowest calcification rates and the only one to endure dissolution in the dark under the future summer scenario, which may threaten its growth rates and survival in shallow depths and lower latitudes.

Given these results, we expect that temperate maerl species will benefit from moderate nutrient enrichment in the winter season, avoiding dissolution under ambient low irradiance levels. Being *L. corallioides* the most abundant species in the Bay of Brest, the significant decrease of its calcification rates in the summer will have a negative impact on the CaCO<sub>3</sub> budget in this location. Furthermore, previous studies have shown a positive impact of ocean acidification on the development of fleshy epiphytic macroalgae (Johnson, Price, & Smith, 2014). Many of the species developing on North Atlantic maerl beds are considered as opportunists (Bunker, Brodie, Maggs, & Bunker, 2017) and may also benefit from the increase of temperature and nutrient availability with negative consequences for maerl survival. In this context, fleshy epiphytic macroalgae compete with maerl for light, carbon, and nutrients (Steneck, 1986). They can also modify the seawater chemistry within the diffusive boundary layer and increase the diel pH fluctuations under future global change scenarios (Short, Pedersen, & Kendrick, 2015). However, epiphytic abundance is also affected by other abiotic and biotic parameters such as hydrodynamics (Hily, Potin, & Floch, 1992), the antifouling ability of coralline algae (Figueiredo, Norton, & Kain, 1997) and grazing by the benthic fauna (Guillou, Grall, & Connan, 2002). Furthermore, coastal ecosystems are highly heterogeneous, and maerl beds located in these ecosystems are subject to different sources of local change which affect their resilience and capacity to adapt to future scenarios of global change (Horta et al., 2016). Due to their slow growth rates (Potin, Floch, Augris, & Cabioch, 1990), activities such as dredging may reduce their abundance at a higher rate than global climate change (Grall & Hall-Spencer, 2003; Hall-Spencer, Grall, Moore, & Atkinson, 2003).

We are aware that the small number of replicates resulting from a constraining experimental design prevented us from carrying out a more powerful single multifactorial analysis. This weakness is a consequence of the process of testing and answering a complex but realistic problem, the combined action of climate change and local eutrophication in a multifactorial experimental design. Therefore, the scope of our study was limited, and our results should be considered carefully. Despite interdependence of replicates per scenario, this paper contains useful information to increase our ability to predict the future effects of ocean acidification.

Such experiment could have been improved by increasing the number of header tanks to avoid pseudo-replication as recommended

by Cornwall and Hurd (2016). However, the number of tank and aquarium units would multiply rapidly in such an experiment, manipulating both climate change scenarios and nutrient concentrations at multiple levels. This would have been prohibitive.

Further studies considering other abiotic parameters and biotic interactions need to be carried in order to develop management policies capable to increase the resilience of maerl beds under the future global climate change scenario.

## ACKNOWLEDGMENTS

We thank the sailors of the Albert Lucas Oceanographic vessel, Franck, and Daniel for their invaluable help during the sampling. This work benefited from a grant of the Consejo Nacional de Ciencia y Tecnología (CONACyT) (391572) and was supported by the French National Research Agency via the "Investment for the Future" program IDEALG (no. ANR-10-BTBR-04). We would like to thank the reviewers and the editor for their thoughtful comments and suggestions toward improving our manuscript.

## CONFLICT OF INTEREST

None declared.

## AUTHOR CONTRIBUTIONS

Z.N.Q.M., S.M., D.D., and J.G. designed research; Z.N.Q.M., J.C., and S.M. performed research; Z.N.Q.M., M.M.-S., and T.C. contributed samples; Z.N.Q.M. and D.D. analyzed data; Z.N.Q.M., S.M., D.D., and J.G. wrote the paper.

## ORCID

Zujaila Nohemy Qui-Minet  <https://orcid.org/0000-0001-6002-5240>

[org/0000-0001-6002-5240](https://orcid.org/0000-0001-6002-5240)

Dominique Davoult  <https://orcid.org/0000-0001-8678-3998>

Miguel Mendez-Sandin  <https://orcid.org/0000-0002-0602-7613>

Sophie Martin  <https://orcid.org/0000-0002-5317-2557>

## DATA AVAILABILITY STATEMENT

All data supporting this study are provided as a Dryad file: <https://doi.org/10.5061/dryad.zkh18935j>

## REFERENCES

- Adey, W. H., & McKibbin, D. L. (1970). Studies on the maerl species *Phymatolithon calcareum* (Pallas) nov. comb. and *Lithothamnium corallioides* (Crouan) in the Ria de Vigo. *Botanica Marina*, 13, 100–106.
- Aminot, A., & Kérouel, R. (2007). *Dosage automatique des nutriments dans les eaux marines: méthodes en flux continu*. Paris, France: IFREMER (p. 188).
- Arar, E. J., & Collins, G. B. (1997). *Method 445.0 in vitro determination of chlorophyll a and pheophytin a in marine and freshwater algae by fluorescence*. Triangle Park, NC: National Exposure Research Laboratory, Office of Research and Development, U.S. Environmental Protection Agency.
- Aufdenkampe, A. K., Mayorga, E., Raymond, P. A., Melack, J. M., Doney, S. C., Alin, S. R., ... Yoo, K. (2011). Riverine coupling of biogeochemical cycles between land, oceans, and atmosphere. *Frontiers in Ecology and Environment*, 9, 53–60. <https://doi.org/10.1890/100014>
- Barange, M., & Harris, R. (2003). *Marine Ecosystems and Global Change*. SCOR, IOC, London: IGBP.
- Belliveau, S. A., & Paul, V. J. (2002). Effects of herbivory and nutrients on the early colonization of crustose coralline and fleshy algae. *Marine Ecology. Progress Series*, 232, 105–114. <https://doi.org/10.3354/meps232105>
- BIOMAERL Team (1998). Maerl grounds: Habitats of high biodiversity in European waters. In K. G. Barthel, H. Barth, M. Bohle-Carbonell, C. Fragakis, E. Lipiatou, P. Martin, ... M. Weydert (Eds.), *Third European marine science and technology conference, (Lisbon, Portugal, 23–27 May 1998), Vol. 1, Marine systems* (pp. 170–178). Brussels, Belgium: European Commission.
- Birkett, D., Maggs, C., & Dring, M. (1998). *Maerl (volume V). An overview of dynamic and sensitivity characteristics for conservation management of marine SACs* (p. 116). Oban, UK: Scottish Association for Marine Science. (UK Marine SACs Project).
- Bjork, M., Mohammed, S. M., Bjorklund, M., & Semesi, A. (1995). Coralline algae, important coral-reef builders threatened by pollution. *Royal Swedish Academy of Sciences*, 24(7/8), 502–505.
- Bordeyne, F., Migné, A., & Davoult, D. (2016). Metabolic activity of intertidal *Fucus* spp. communities: Evidence of high aerial carbon fluxes displaying seasonal variability. *Marine Biology*, 162, 2119–2129.
- Brodie, J., Williamson, C. J., Smale, D. A., Kamenos, N. A., Mieszkowska, N., Santos, R., ... Hall-Spencer, J. M. (2014). The future of the NE Atlantic benthic flora in a high CO<sub>2</sub> world. *Ecology and Evolution*, 4, 2787–2789.
- Bunker, F. S. D., Brodie, J. A., Maggs, C. A., & Bunker, A. R. (2017). *Seaweeds of Britain and Ireland* (2nd ed., p. 312). Plymouth, UK: Wild Nature Press.
- Burdett, H. L., Keddie, V., MacArthur, N., McDowall, L., McLeish, J., Spielvogel, E., ... Kamenos, N. A. (2014). Dynamic photo-inhibition exhibited by red coralline algae in the red sea. *BMC Plant Biology*, 14, 139. <https://doi.org/10.1186/1471-2229-14-139>
- Celis-Plá, P. S. M., Hall-Spencer, J. M., Antunes-Horta, P., Milazzo, M., Korbee, N., Cornwall, C. E., & Figueroa, F. L. (2015). Macroalgal responses to ocean acidification depend on nutrient and light levels. *Frontiers in Marine Science*, 2, 26. <https://doi.org/10.3389/fmars.2015.00026>
- Chalker, B. E., & Taylor, D. L. (1975). Light-enhanced calcification, and the role of oxidative phosphorylation in calcification of the coral *Acropora cervicornis*. *Proceedings of the Royal Society London, Series B*, 201, 179–189.
- Chow, F. (2012). Nitrate assimilation: The role of in vitro nitrate reductase assay as nutritional predictor. In M. Najafpour (Ed.), *Applied Photosynthesis* (p. 422). Rijeka, Croatia: In Tech.
- Cornwall, C. E., Hepburn, C. D., Pilditch, C. A., & Hurd, C. L. (2013). Concentration boundary layers around complex assemblages of macroalgae: Implications for the effects of ocean acidification understorey coralline. *Limnology and Oceanography*, 58(1), 121–130.
- Cornwall, C. E., & Hurd, C. L. (2016). Experimental design in ocean acidification research: Problems and solutions. *ICES Journal of Marine Science*, 73(3), 572–581.
- Croce, R., & Van Amerongen, H. (2014). Natural strategies for photosynthetic light harvesting. *Nature Chemical Biology*, 10, 492–498. <https://doi.org/10.1038/nchembio.1555>
- Daniel, A. (1995). *Le cycle de l'azote en écosystème côtier: Développement d'un analyseur submersible pour la mesure in situ des nitrates et nitrites; variations saisonnières de la production azotée phytoplanktonique*. PhD Thesis, Université de Bretagne Occidentale.
- Davison, I., Jordan, T., Fegley, J., & Grobe, C. (2007). Response of *Laminaria saccharina* (Phaeophyta) growth and photosynthesis to simultaneous ultraviolet radiation and nitrogen limitation. *Journal of Phycology*, 43, 636–646.
- De Beer, D., & Larkum, A. W. D. (2001). Photosynthesis and calcification in the calcifying algae *Halimeda discoidea* studied with



- microsensors. *Plant Cell and Environment*, 24, 1209–1217. <https://doi.org/10.1046/j.1365-3040.2001.00772.x>
- Diaz-Pulido, G., & McCook, L. (2008). Macroalgae (Seaweeds). In A. Chin (Ed.), *The state of the great barrier reef on-line* (pp. 1–44). Townsville, Qld, Australia: Great Barrier Reef Marine Park Authority.
- Dickson, A. G., Afghan, J. D., & Anderson, G. C. (2003). Reference materials for oceanic CO<sub>2</sub> analysis: A method for the certification of total alkalinity. *Marine Chemistry*, 80, 185–197. [https://doi.org/10.1016/S0304-4203\(02\)00133-0](https://doi.org/10.1016/S0304-4203(02)00133-0)
- Dickson, A. G., & Millero, F. J. (1987). A comparison of the equilibrium constants for the dissociation of carbonic acid in seawater media. *Deep Sea Research*, 34, 1733–1743.
- Dickson, A. G., Sabine, C. L., & Christian, J. R. (2007). *Guide to best practices for ocean CO<sub>2</sub> measurements PICES special publication* (p. 176). Sidney, BC, Canada: North Pacific Marine Science Organization.
- Duarte, C., Hendriks, I., Moore, T., Olsen, Y., Steckbauer, A., Ramajo, L., ... McCulloch, M. (2013). Is ocean acidification an open-ocean syndrome? Understanding anthropogenic impacts on seawater pH. *Estuaries and Coasts*, 36, 221–236. <https://doi.org/10.1007/s12237-013-9594-3>
- Egilsdottir, H., Noisette, F., Noël, L.-M.-L.-J., Olafsson, J., & Martin, S. (2013). Effects of pCO<sub>2</sub> on physiology and skeletal mineralogy in a tidal pool coralline alga *Corallina elongata*. *Marine Biology*, 160, 2103–2112. <https://doi.org/10.1007/s00227-012-2090-7>
- Eilers, P. H. C., & Peeters, J. C. H. (1988). A model for the relationship between light intensity and the rate of photosynthesis in phytoplankton. *Ecological Modelling*, 42, 199–215.
- Fabry, V. J., Seibel, B. A., Feely, R. A., & Orr, J. C. (2008). Impacts of ocean acidification on marine fauna and ecosystem processes. *ICES Journal of Marine Science*, 65, 414–432. <https://doi.org/10.1093/icesjms/fsn048>
- Falkenberg, L. J., Connell, S. D., & Russel, B. D. (2013). Disrupting the effects of synergies between stressors: Improved water quality dampens the effect of CO<sub>2</sub> on a marine habitat. *Journal of Applied Ecology*, 50, 51–58.
- Figueiredo, M. A., Norton, T. A., & Kain, J. M. (1997). Settlement and survival of epiphytes on two intertidal crustose coralline algae. *Journal of Experimental Marine Biology and Ecology*, 213(2), 247–260. [https://doi.org/10.1016/S0022-0981\(96\)02766-9](https://doi.org/10.1016/S0022-0981(96)02766-9)
- Fogg, G. E. (1953). *The metabolism of algae* (p. 149). London, UK: Methuen.
- Ford, H., Hardy, F. G., & Edyvean, R. G. J. (1983). Population biology of the crustose red alga *Lithophyllum incrustans* Phil. Three populations on the east coast of Britain. *Journal of Linnean Society*, 23, 353–363. <https://doi.org/10.1111/j.1095-8312.1983.tb00784.x>
- Foster, M. S. (2001). Rhodoliths: Between rocks and soft places. *Journal of Phycology*, 37, 659–667. <https://doi.org/10.1046/j.1529-8817.2001.00195.x>
- Gattuso, J. P., Magnan, A., Billé, R., Cheung, W. L., Howes, E. L., Joos, F., ... Turley, C. M. (2015). Contrasting futures for ocean and society from different anthropogenic CO<sub>2</sub> emissions scenarios. *Science*, 349, aac4722.
- Gevaert, F., Davoult, D., Creach, A., Kling, R., Janquin, M. A., Seuront, L., & Lemoine, Y. (2001). Carbon and nitrogen content of *Laminaria saccharina* in the eastern English Channel: Biometrics and seasonal variations. *Journal of Marine Biology Association UK*, 81, 727–734.
- Grall, J. (2002). *Biodiversité spécifique et fonctionnelle du maerl: réponses à la variabilité de l'environnement côtier. PhD thesis, Université de Bretagne Occidentale, Brest, France.*
- Grall, J., & Hall-Spencer, J. M. (2003). Problems facing maerl conservation in Brittany. *Aquatic Conservation: Marine and Freshwater Ecosystems*, 13, S55–S64. <https://doi.org/10.1002/aqc.568>
- Guillou, M., Grall, J., & Connan, S. (2002). Can low sea urchin densities control macro-epiphytic biomass in a north-east Atlantic maerl bed ecosystem (Bay of Brest, Brittany, France)? *Journal of the Marine Biological Association UK*, 82, 867–876. <https://doi.org/10.1017/S0025315402006276>
- Hall-Spencer, J. M., Grall, J., Moore, P. G., & Atkinson, R. J. A. (2003). Bivalve fishing and maerl-bed conservation in France and the UK – Retrospect and prospect. *Aquatic Conservation: Marine and Freshwater Issues*, 13, S35–S41. <https://doi.org/10.1002/aqc.566>
- Harrison, P. J., & Hurd, C. L. (2001). Nutrient physiology of seaweeds: Application of concepts to aquaculture. *Cahiers De Biologie Marine*, 42, 71–82.
- Hernández-Kantún, J., Hall-Spencer, J. M., Grall, J., Adey, W., Rindi, F., Maggs, C. A., ... Peña, V. (2016). Conservation status of rhodolith/maerl at major ocean basins. In R. Riosmena-Rodríguez, W. Nelson, & J. Aguirre (Eds.), *Rhodolith/maerl beds: A global perspective* (p. 362). Cham, Switzerland: Springer International Publishing.
- Hernández-Kantún, J., Rindi, F., Adey, W. H., Heesch, S., Peña, V., Le Gall, L., & Gabrielson, P. W. (2015). Sequencing type material resolves the identity and distribution of the genertype *Lithophyllum incrustans*, and related European species *L. hibernicum* and *L. bathyporum* (Corallinales, Rhodophyta). *Journal of Phycology*, 51(4), 791–807.
- Hily, C., Potin, P., & Floc'h, J.-Y. (1992). Structure of subtidal algal assemblages on soft-bottom sediments: Fauna/flora interactions of role of disturbances in the Bay of Brest, France. *Marine Ecology Progress Series*, 85, 115–130.
- Hofmann, L. C., Heiden, J., Bischof, K., & Teichberg, M. (2014). Nutrient availability affects the response of the calcifying chlorophyte *Halimeda opuntia* (L.) J.V. Lamouroux to low pH. *Planta*, 239, 231–242.
- Hofmann, L. C., Straub, S., & Bischof, K. (2013). Elevated CO<sub>2</sub> levels affect the activity of nitrate reductase and carbonic anhydrase in the calcifying rhodophyte *Corallina officinalis*. *Journal of Experimental Botany*, 64, 899–990. <https://doi.org/10.1093/jxb/ers369>
- Horta, P. A., Riul, P., Amado-Filho, G., Gurgel, C. F. D., Berchez, F., Castro-Nunes, J. M., ... Figueiredo, M. (2016). Rhodoliths in Brazil: Current knowledge and potential impacts of climate change. *Brazilian Journal of Oceanography*, 64(sp2), 117–136. <https://doi.org/10.1590/S1679-875920160870064sp2>
- Hurd, C. L., Harrison, P. J., Bischof, K., & Lobban, C. S. (2014). *Seaweed ecology and physiology* (2nd ed.). Cambridge, UK: Cambridge University Press.
- Johnson, M. D., Price, N. N., & Smith, J. E. (2014). Contrasting effects of ocean acidification on tropical fleshy and calcareous algae. *PeerJ*, 2, e411. <https://doi.org/10.7717/peerj.411>
- Kinsey, D. W., & Davies, P. J. (1979). Effects of elevated nitrogen and phosphorus on coral-reef growth. *Limnology and Oceanography*, 24, 935–940.
- Langdon, C., & Atkinson, M. J. (2005). Effect of elevated Pco<sub>2</sub> on photosynthesis and calcification of corals and interactions with seasonal change in temperature/irradiance and nutrient enrichment. *Journal of Geophysical Research-Oceans*, 110, C09S07.
- Le Pape, O., & Menesguen, A. (1997). Hydrodynamic prevention of eutrophication in the Bay of Brest (France), a modelling approach. *Journal of Marine Systems*, 12, 171–186. [https://doi.org/10.1016/S0924-7963\(96\)00096-6](https://doi.org/10.1016/S0924-7963(96)00096-6)
- Legendre, P., & Legendre, L. (1998). Numerical ecology. In *Developments in environmental modelling* (Vol. 20, 2nd English ed., p. 853). Amsterdam, The Netherlands: Elsevier Science B.V.
- Legrand, E., Riera, P., Pouliquen, L., Bohner, O., Cariou, T., & Martin, S. (2018). Ecological characterization of intertidal rock pools: Seasonal and diurnal monitoring of physico-chemical parameters. *Regional Studies in Marine Science*, 17, 1–10.
- Lewis, E., & Wallace, D. W. R. (1998). *Program developed for CO<sub>2</sub> system calculations. Carbon Dioxide Information Analysis Center, Oak Ridge National Laboratory, U.S Department of Energy.*

- Magnusson, G., Larsson, C., & Axelsson, L. (1996). Effects of high CO<sub>2</sub> treatment on nitrate and ammonium uptake by *Ulva lactuca* grown in different nutrient regimes. *Scientia Marina*, *60*, 179–189.
- Marshall, A. T., & Clode, P. (2002). Effect of increased calcium concentration in sea water on calcification and photosynthesis in the scleractinian coral *Galaxea fascicularis*. *Journal of Experimental Biology*, *205*, 2107–2113.
- Martin, S., Castets, M.-D., & Clavier, J. (2006). Primary production, respiration and calcification of the temperate free-living coralline alga *Lithothamnion corallioides*. *Aquatic Botany*, *85*, 121–128. <https://doi.org/10.1016/j.aquabot.2006.02.005>
- Martin, S., Charnoz, A., & Gattuso, J.-P. (2013). Photosynthesis, respiration and calcification in the Mediterranean crustose coralline alga *Lithophyllum cabiochae* (Corallinales, Rhodophyta). *European Journal of Phycology*, *48*(2), 163–172.
- Martin, S., Clavier, J., Chavaud, L., & Thouzeau, G. (2007). Community metabolism in temperate maerl beds. I. Carbon and carbonate fluxes. *Marine Ecology Progress Series*, *335*, 19–29. <https://doi.org/10.3354/meps335019>
- Martin, S., Cohu, S., Vignot, C., Zimmerman, G., & Gattuso, J. P. (2013). One-year experiment on the physiological response of the Mediterranean crustose coralline algae, *Lithophyllum cabiochae*, to elevated pCO<sub>2</sub> and temperature. *Ecology and Evolution*, *3*(3), 676–693.
- Martin, S., & Gattuso, J.-P. (2009). Response of Mediterranean coralline algae to ocean acidification and elevated temperature. *Global Change Biology*, *15*, 2089–2100. <https://doi.org/10.1111/j.1365-2486.2009.01874.x>
- Martin, S., & Hall-Spencer, J. M. (2017). Effects of ocean warming and acidification on rhodolith/maerl beds. In R. Riosmena-Rodríguez, W. Nelson, & J. Aguirre (Eds.), *Rhodolith/maerl beds: A global perspective* (p. 362). Cham, Switzerland: Springer International Publishing.
- McCoy, S. J., & Kamenos, N. A. (2015). Coralline algae (Rhodophyta) in a changing world: Integrating ecological, physiological, and geochemical responses to global change. *Journal of Phycology*, *51*, 6–24. <https://doi.org/10.1111/jpy.12262>
- Mehrbach, C., Culberson, C. H., Hawley, J. E., & Pytkowicz, R. N. (1973). Measurements of the apparent dissociation constants of carbonic acid in seawater at atmospheric pressure. *Limnology and Oceanography*, *18*, 897–907.
- Morse, J. W., Andersson, A. J., & Mackenzie, F. T. (2006). Initial responses of carbonate-rich shelf sediments to rising atmospheric pCO<sub>2</sub> and “ocean acidification”: Role of high Mg-calcites. *Geochimica Et Cosmochimica Acta*, *70*, 5814–5830. <https://doi.org/10.1016/j.gca.2006.08.017>
- Noisette, F., Egilsdottir, H., Davoult, D., & Martin, S. (2013). Physiological responses of three temperate coralline algae from contrasting habitats to near-future ocean acidification. *Journal of Experimental Marine Biology and Ecology*, *448*, 179–187. <https://doi.org/10.1016/j.jembe.2013.07.006>
- Platt, T., Gallegos, C. L., & Harrison, W. G. (1980). Photoinhibition of photosynthesis in natural assemblages of marine phytoplankton. *Journal of Marine Research*, *38*, 687–701.
- Potin, P., Flocc'h, J.-Y., Augris, C., & Cabioch, J. (1990). Annual growth rate of the calcareous red algae *Lithothamnion corallioides* (Corallinales, Rhodophyta) in the Bay of Brest, France. *Hydrobiologia*, *204*, 263–267.
- Qui-Minet, Z. N., Delaunay, C., Grall, J., Six, C., Cariou, T., Bonher, O., ... Martin, S. (2018). The role of local environmental changes on maerl and its associated non-calcareous epiphytic flora in the Bay of Brest. *Estuarine Coastal and Shelf Science*, *208*(31), 140–152. <https://doi.org/10.1016/j.ecss.2018.04.032>
- R Core Team. (2017). *R: A language and environment for statistical computing*. Vienna, Austria: R Foundation for Statistical Computing.
- Ramajo, L., Pérez-León, E., Hendriks, I. E., Marbà, N., Krause-Jensen, D., Sejr, M. K., ... Duarte, C. M. (2016). Food supply confers calcifiers resistance to ocean acidification. *Scientific Reports*, *6*, 19374. <https://doi.org/10.1038/srep19374>
- Ravaglioli, C., Lauritano, C., Buia, M. C., Balestri, E., Capocchi, A., Fontanini, D., ... Bulleri, F. (2017). Nutrient enrichment offsets negative effects of ocean acidification in seagrass meadows. *Scientific Reports*, *7*, 13732.
- Raven, J. A., Giordano, M., Beardall, J., & Maberly, S. C. (2012). Algal evolution in relation to atmospheric CO<sub>2</sub>: Carboxylases, carbon-concentrating mechanisms and carbon oxidation cycles. *Philosophical Transactions of the Royal Society Biological Sciences*, *367*, 493–507.
- Russel, B. D., & Connell, S. D. (2009). Eutrophication science: Moving into the future. *Trends in Ecology and Evolution*, *24*, 00–10.
- Salisbury, J., Green, M., Hunt, C., & Campbell, J. (2008). Coastal acidification by rivers: A threat to shellfish? *EOS*, *89*, 513–528. <https://doi.org/10.1029/2008EO500001>
- Salt, L. A., Beaumont, L., Blain, S., Bucciarelli, E., Grossteffan, E., Guillot, A., ... Bozec, Y. (2015). The annual and seasonal variability of the carbonate system in the Bay of Brest (northwest Atlantic Shelf). *Marine Chemistry*, *187*, 1–15.
- Scherrer, B. (2007). *Biostatistique* (Vol. 1, 2nd ed., p. 816). Editeur Gaëtan Morin.
- Schoepf, V., Grottole, A. G., Warner, M. E., Cai, W. J., Melman, T. F., Hoadley, K. D., ... Baumann, J. H. (2013). Coral energy reserves and calcification in a high-CO<sub>2</sub> world at two temperatures. *PLoS ONE*, *9*(9), e108082. <https://doi.org/10.1371/journal.pone.0075049>
- Short, J. A., Pedersen, O., & Kendrick, G. A. (2015). Turf algal epiphytes metabolically induce local pH increase, with implications for underlying coralline algae under ocean acidification. *Estuarine, Coastal and Shelf Science*, *164*, 463–470. <https://doi.org/10.1016/j.ecss.2015.08.006>
- Simkiss, (1964). Phosphates as crystal poisons for calcification. *Biological Reviews*, *39*, 487–505.
- Smith, A. D., & Key, G. S. (1975). Carbon-dioxide and metabolism in marine environments. *Limnology and Oceanography*, *20*, 493–495.
- Solorzano, L. (1969). Determination of ammonia in natural waters by the phenylhypochlorite method. *Limnology and Oceanography*, *14*, 799–801.
- Steller, D. L., Riosmena-Rodríguez, R., Foster, M. S., & Roberts, C. A. (2003). Rhodolith bed diversity in the Gulf of California: The importance of rhodolith structure and consequences of anthropogenic disturbances. *Aquatic Conservation: Marine and Freshwater Ecosystems*, *13*, S5–S20.
- Steneck, R. S. (1986). The ecology of coralline algal crusts: Convergent patterns and adaptive strategies. *Annual Review of Ecology, Evolution, and Systematics*, *17*, 273–303. <https://doi.org/10.1146/annurev.es.17.110186.001421>
- Strong, A. L., Kroeker, K. L., Teneva, L. T., Mease, L. A., & Kelly, R. P. (2014). Ocean acidification 2.0: Managing our changing coastal ocean chemistry. *BioScience*, *64*, 581–592. <https://doi.org/10.1093/biosci/biu072>
- Tanaka, Y., Iguchi, A., Inoue, M., Mori, C., Sakai, K., Suzuki, A., ... Nakamura, T. (2013). Microscopic observation of symbiotic and aposymbiotic juvenile corals in nutrient-enriched seawater. *Marine Pollution Bulletin*, *68*, 93–98. <https://doi.org/10.1016/j.marpolbul.2012.12.017>
- Vazquez-Elizondo, R. M., & Enriquez, S. (2016). Coralline algal physiology is more adversely affected by elevated temperature than reduced pH. *Scientific Reports*, *6*, 19030. <https://doi.org/10.1038/srep19030>
- Williamson, C. J., Brodie, J., Goss, B., Yallop, M., Lee, S., & Perkins, R. (2014). Corallina and Ellisolandia (Corallinales, Rhodophyta) photo-physiology over daylight tidal emersion: Interactions with irradiance, temperature and carbonate chemistry. *Marine Biology*, *161*, 2051–2068. <https://doi.org/10.1007/s00227-014-2485-8>
- Williamson, C. J., Perkins, R., Voller, M., Yallop, M. L., & Brodie, J. (2017). The regulation of coralline algal physiology, an *in situ* study



of *Corallina officinalis* (Corallinales, Rhodophyta). *Biogeosciences*, 14, 4485–4498.

Wolf-Gladrow, D. A., Zeebe, R. E., Klaas, C., Kortzinger, A., & Dickson, A. G. (2007). Total alkalinity: The explicit conservative expression and its application to biogeochemical processes. *Marine Chemistry*, 106, 287–300. <https://doi.org/10.1016/j.marchem.2007.01.006>

#### SUPPORTING INFORMATION

Additional supporting information may be found online in the Supporting Information section.

**How to cite this article:** Qui-Minet ZN, Coudret J, Davoult D, et al. Combined effects of global climate change and nutrient enrichment on the physiology of three temperate maerl species. *Ecol Evol*. 2019;9:13787–13807. <https://doi.org/10.1002/ece3.5802>