

# A Review on Recent Trends and Future Developments in Electrochemical Sensing

Rimmy Singh,\* Ruchi Gupta, Deepak Bansal, Rachna Bhateria, and Mona Sharma\*



Cite This: *ACS Omega* 2024, 9, 7336–7356



Read Online

ACCESS |

Metrics & More

Article Recommendations

**ABSTRACT:** Electrochemical methods and devices have ignited prodigious interest for sensing and monitoring. The greatest challenge for science is far from meeting the expectations of consumers. Electrodes made of two-dimensional (2D) materials such as graphene, metal–organic frameworks, MXene, and transition metal dichalcogenides as well as alternative electrochemical sensing methods offer potential to improve selectivity, sensitivity, detection limit, and response time. Moreover, these advancements have accelerated the development of wearable and point-of-care electrochemical sensors, opening new possibilities and pathways for their applications. This Review presents a critical discussion of the recent developments and trends in electrochemical sensing.

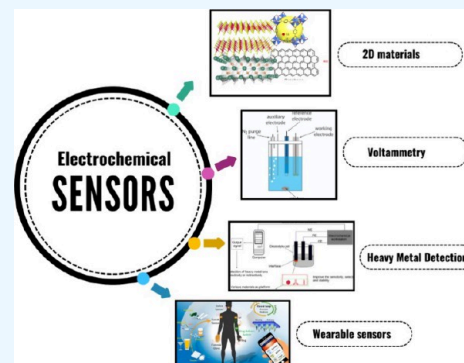

## INTRODUCTION

The use of microanalytical tools for the measurement of chemical compounds is attractive for real-time on-site monitoring. Several commonly used microanalytical tools comprise chemical sensors and have been successfully commercialized.<sup>1</sup> According to IUPAC,<sup>2</sup> chemical sensors can convert chemical data into analytically usable information that ranges from chemical concentrations to composition. A chemical sensor consists of two fundamental functional units: a receptor and a physicochemical transducer. Ideally, sensors should be able to produce a signal output proportional to the concentration of target species as well as offer high selectivity, sensitivity, repeatability, and rapid response time.<sup>3</sup>

Electrochemical sensors have been one of the most explored research areas. The ability of electrochemical sensors to selectively detect targets of interest is highly dependent on electrode materials and/or bioreceptors on electrodes.<sup>4,5</sup> In electrochemical sensors, when the target analyte interacts with electrode materials and/or bioreceptors in electrodes, the response obtained can be converted into measurable signal denoting the analyte concentration. The advantages of electrochemical sensors over other sensing strategies include the ability to miniaturize and fabricate them in a cost-effective manner, the fast response time and multiplexing capabilities, and the potential for portable (even wearable) measurement instrumentation.<sup>6,7</sup> When Heyrovsky invented polarography in 1922, electroanalytical methods come into existence. Nevertheless, in the past decade, this field has grown tremendously and is undergoing a real renaissance.<sup>8</sup> Rigid substrate screen printed electrodes replaced the electrochemical analytical

assays as they require just a few microliters of volume cells and swapped for a cluster of advanced electrode configurations. Now there are electrodes that can be made on almost any substrate, including ceramics, glasses, plastics, threads made of textiles, and even on skin.<sup>9,10</sup> Furthermore, all sorts of nanomaterials have been utilized to modify traditional electrode materials and improve their selectivity.<sup>11,12</sup> Currently, classical electrochemical instruments are limited to analytical laboratories. Therefore, microcontrollers are being used to replace traditional laboratory instruments with portable hand-held instruments that are efficient in measuring analytes in-field without compromising accuracy.<sup>13</sup> Electrochemical devices have shown wide linear response, and hence, a broad spectrum of chemical substances have been measured using electrochemical sensors.

Figure 1 illustrates three electrodes of an electrochemical sensor: the “working electrode” (WE), the “counter electrode” (CE), and the “reference electrode” (RE). An electrocatalytic reaction occurs in WE and is enhanced by the addition of various nanomaterials. Alahi and Mukhopadhyay<sup>14</sup> describe that CE closes the circuit, ensuring that electrons continue to flow, while RE ensures that WE potential is applied correctly. Nowadays, various electroanalytical methods have been

**Received:** October 14, 2023

**Revised:** January 7, 2024

**Accepted:** January 12, 2024

**Published:** February 6, 2024



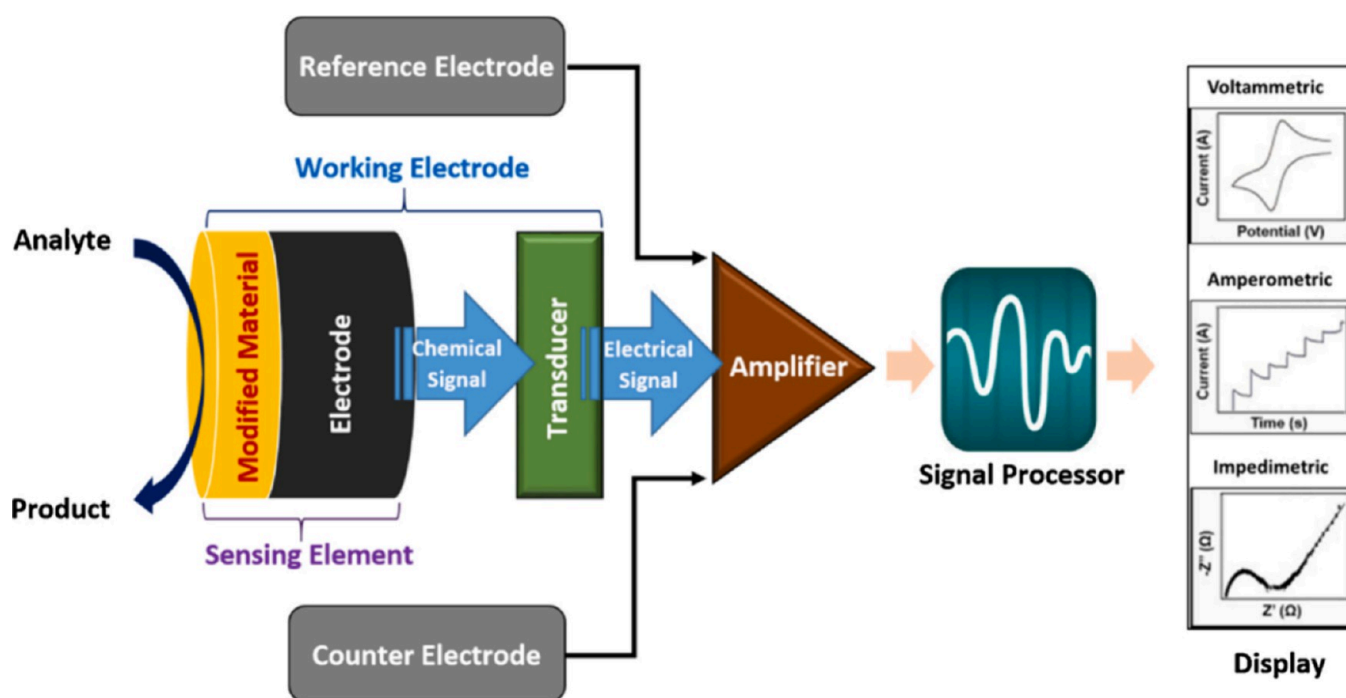

Figure 1. Schematic diagram of an electrochemical sensor. Reprinted with permission from ref 22. Copyright 2021 Elsevier.

introduced depending upon the interaction between analyte and the nanomaterials employed to modify the WE. Conventionally, carbon and gold are the most common electrode materials. The stability, biocompatibility, and good electron transfer kinetics of these materials make them popular among researchers. Electrochemical detection of trace analytes is often impossible on unmodified surfaces owing to their lesser sensitivity and selectivity. The electrode surfaces have therefore been incorporated with nanomaterials to overcome this challenge.<sup>15,16</sup> When interferences are present, high selectivity is offered by the modified electrodes. Various nanostructured materials are found capable of refining and sensitizing electrode surfaces, including nanocarbons, nanoparticles (NPs), conductive polymers, and nanocomposites. Catalysis, biomedical, imaging, optoelectronics, and others are among the fields exhibiting great interest in metallic nanoparticles. In comparison with its macroscale counterparts, NPs exhibit dominant biological and physiochemical characteristics.<sup>17</sup> The morphology and size of nanomaterials ranging from 1 to 100 nm make them extremely advantageous. Enhanced interfacial adsorption, biocompatibility, and faster electron transfer kinetics can be achieved on sensor surface by using modified nanomaterials. A combination of these properties enables the sensor to detect specific analytes more selectively and more sensitively, as well as achieve a better overall performance.<sup>15,16,18–21</sup>

A number of analytical techniques have been used thus far, including high-performance liquid chromatography (HPLC),<sup>23,24</sup> inductively coupled plasma mass spectrometry (ICP-MS),<sup>25</sup> spectrofluorimetry,<sup>26</sup> GC/mass spectrometry (GC/MS),<sup>27</sup> gas chromatography (GC),<sup>28</sup> capillary electrophoresis,<sup>29</sup> chemiluminescence,<sup>30</sup> and atomic absorption spectrometry (AAS)<sup>31</sup> for the analyte detection. High analytical costs, sophisticated instruments, and time-consuming pretreatment are some of the disadvantages that lead to their limitation in application. Electrochemical sensing

approaches are partially capable of supplying high reliability, inexpensive, and quick techniques for determining different pollutants in the environment,<sup>32</sup> health, and other sectors.

It has already been demonstrated that electrochemical sensors can perform analytically at levels adequate to meet health, environmental, and security applications. Research, as with all things, is constantly evolving. Usability and affordability, however, are typically the barriers to commercialization and adoption, as will be argued here. A sensor's utility is ultimately limited by the weakest of these three aspects (analytical performance, usability, and affordability), all working together to ensure these conditions are met.<sup>33</sup> Hence, in this paper, we tried to summarize the recent progress in electrochemical sensing platforms with focus on their analytical performance, and strategies. Also, the aim of this Review is to critically discuss two-dimensional (2D) materials used for electrochemical sensors. Another aim is to discuss emerging applications of electrochemical sensors. Finally, we have critically discussed the advances made and challenges that need to be addressed for making electrochemical sensors attractive for wearable and point-of-care measurements.

## ■ MATERIALS USED FOR ELECTRODE MODIFICATION

To enhance the electrochemical properties, the selection of electrode material is a serious consideration. In lieu of this, carbon and 2D materials have shown tremendous potential to be the best candidates for electrode materials. Novel 2D materials such as transitional metal dichalcogenides (TMDS), MXene, and metal–organic frameworks (MOFs) have paved the way for modification of electrodes to elevate sensitivity and selectivity in electrochemical sensors. Here we have reviewed 2D materials because of an exponential increase in the number of studies reported by different researchers<sup>34</sup> on their applicability in the current sensing technologies. More

importantly, 2D materials are ideally single layered materials restricting thickness to only a few nanometers, thus imparting high surface to volume ratio.<sup>35</sup> Furthermore, their conductivity can be tuned by increasing the number of layers, controlling structural defects, and doping.<sup>36</sup>

**Metal–Organic Frameworks (MOFs).** In the past few decades, a relatively novel category of nano porous materials called MOFs has been introduced.<sup>37</sup> MOFs are ultrathin 2D nanosheets with high surface area and porosity.<sup>38,39</sup> For the synthesis of MOFs, functional coordination polymers distribute transition metal compounds uniformly on organic surfaces.<sup>40</sup> Morphology and size of MOF nanocomposites are strongly dependent on their growth time and pyrolysis temperature.<sup>41–43</sup> Interconnected pore structure, high specific area, tunable chemical properties, and uniform pore size are some of the characteristics that distinguish MOFs from other porous materials. Brunauer–Emmett–Teller (BET) surface area of MOFs is higher when compared with other materials such as graphene, carbon nanotubes (CNTs), and zeolites.<sup>44</sup> MOFs have gained attention in gas adsorption,<sup>45</sup> separation of gases,<sup>46</sup> sensing,<sup>47</sup> catalyzing reactions,<sup>48</sup> and storing energy.<sup>49</sup> However, it has been argued that MOFs are ideal porous supports for catalysis because they can incorporate spatially dispersed active sites with high densities<sup>50</sup> either through rational framework designs or postsynthesis methods. Therefore, a MOF thin film incorporating electrochemically active sites with high density and spatial accessibility would be an attractive candidate for electrochemical applications, especially electrocatalysis.<sup>51</sup> It has been shown that MOFs are a promising electrochemical sensing platform because of their periodic network structures, unsaturated metal coordination sites, and unique structural properties, including large surfaces, and cavities.<sup>52,53</sup> With these unique characteristics, MOFs can be used as effective electrocatalytic electrode coatings for sensing applications, resulting in higher catalytic capacity. In addition, MOFs possess excellent porosity and surface area, which allow for high efficiency concentration and mass transfer of analytes, which enhance detection sensitivity and signal amplification. Moreover, MOF-based matrices have excellent selectivity toward specific analytes as they possess specific morphology and size of the channels and cavities.

To demonstrate the electrochemical sensing abilities of MOFs, Zhang et al. performed experiments for the detection of chloramphenicol with a novel GCE formed from MIL-101(Cr)/XC-72 nanostructured with carbon black. Differential pulse voltammetry (DPV) and cyclic voltammetry (CV) approaches were used to investigate the electrochemical performance of the deliberated sensor, which demonstrated well-defined redox peaks close to chloramphenicol in the phosphate buffer solution (PBS). Furthermore, chloramphenicol could also be detected in honey, eye drops, and milk with satisfactory recovery with the MIL-101(Cr)/XC-72/GCE sensor.<sup>54</sup> In another study, a Cu-MOF was synthesized by Yuan et al. to explore its electrocatalytic efficiency toward H<sub>2</sub>O<sub>2</sub> and glucose.<sup>55</sup> Also, a one-step hydrothermal treatment of macroporous carbon (MPC) and Co-MOF results in a composite verified to be an excellent electrochemical sensor showing a high sensitivity of 132.4  $\mu\text{A } \mu\text{M}^{-1}$  toward the determination of nitrobenzene and hydrazine.<sup>56</sup> In a work reported by Wang et al. a Ni-based MOF was prepared for enhancing the glucose electrochemical sensing performance. The sensitivity for glucose detection has been increased up to 2124.90  $\mu\text{A}$ .<sup>57</sup> In another study, Li et al. elevated glucose

sensing by overcoming the shortcomings of original MOFs, i.e., by surface functionalization using halogen pyridine. The electrocatalytic performance of the sensor enhanced and generated a quick response in a time of less than 2 s.<sup>58</sup>

For improving electrochemical sensor's sensitivity, uniform distribution and highly accessible active sites have become obligatory for MOF-based electrocatalysts (Figure 2).<sup>59</sup> It is

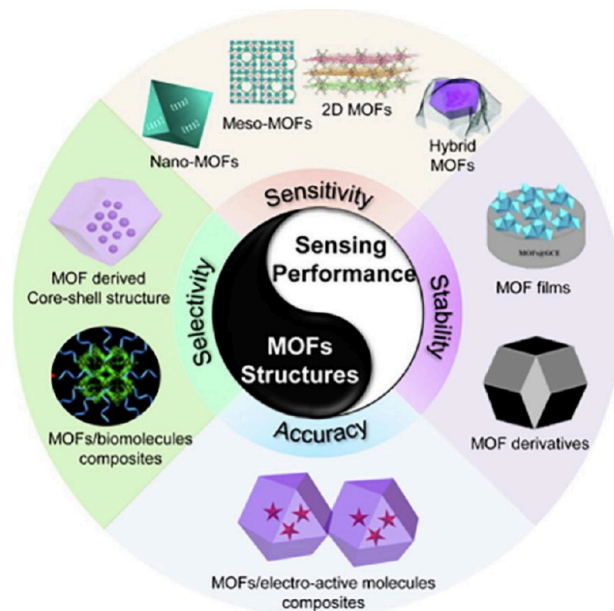

**Figure 2.** Schematic showing the relationship between the structure of MOF and their analytical performance.<sup>62,66–72</sup> Reprinted with permission from ref 73. Copyright 2020 Elsevier.

possible to obtain sensors with the desired sensitivities by synthesizing nanoMOFs, mesoMOFs, 2D MOFs, conductive functional species, and MOF smart composites.<sup>60–63</sup> To get the desired stability and reproducibility in an electrochemical sensor, 3D self-supported and 2D MOF thin films with consistent and restrained film thickness have been developed, thus preventing electroactive materials from getting separated from electrodes and immobilization on MOFs uniformly.<sup>64,65</sup>

**Graphene.** Recently, graphene has attracted attention as an emerging carbon nanomaterial. In electrochemical sensing applications, graphene has been widely used owing to its remarkable physical and electrochemical properties.<sup>74</sup> A semimetal, graphene has a zero band gap and can therefore be considered a semiconductor.<sup>75</sup> In addition, it exhibits a striking ambipolar electric field effect, allowing the gate voltage to be adjusted to tune the type of charge carrier.<sup>76</sup>

According to Qi et al. pristine graphene was used to prepare a highly sensitive abscisic acid (AA) sensor. Organic salt-assisted exfoliation is used to prepare pristine graphene. Compared with chemically converted graphene (CCG), the sensor showed excellent sensor characteristics. Its conductivity was 13 000  $\text{Sm}^{-1}$ , significantly greater than thermal reduced graphene oxide (rGO) or CCG (1250  $\text{Sm}^{-1}$ ).<sup>77</sup> However, the conductivity of graphene deteriorates significantly when synthesized by the CCG method.<sup>78,79</sup> Furthermore, graphene has been coupled with other nanomaterials, and the resulting nanocomposites and nanohybrids show unique and synergistic electrochemical performance.<sup>80–82</sup> A variety of voltammetric, amperometric, and potentiometric sensors have used graphene

Table 1. Electrochemical Sensing Platform Synthesized from Different Electrode Materials

Material	Modified electrode	Technique	Linear range	Limit of detection	Target	Sensitivity	Ref
Ti <sub>3</sub> C <sub>2</sub> T	SPE/MXene/Au Pd/GA/ACHe	DPV	0.1–1000 μg/L	1.75 ng/L	POX		92
g-C <sub>3</sub> N <sub>4</sub>	Pd/g-C <sub>3</sub> N <sub>4</sub> /GCE	DPV	0.01–15 μg/L	9 ng/L	Hg <sup>2+</sup>	-	103
-	NiCo-MOF	Amp	1 μM <sup>-8</sup> mM	0.29 μM	Glc	0.6844 μA/mM cm <sup>2</sup>	42
-	Ni-MOF/GCE	Amp	0.5 <sup>-8</sup> mM	0.23 μM	N <sub>2</sub> H <sub>4</sub>	2412 μA/μM.cm <sup>2</sup>	104
-	NiO/Fe <sub>2</sub> O <sub>3</sub> /NiCo <sub>2</sub> O <sub>4</sub>	EIS	0.172 fM–1.72 nM	0.16 fM	Insulin		105
-	Fe <sup>3+</sup> @ε-MnO <sub>2</sub>	EIS and CV	0.02–78 μM	5 nM	DA	242.6 μA/mM cm <sup>2</sup>	106
-	MOF-818@RGO/MWCNTs-3/GCE	DPV	0.2–7 μM and 7–50 μM	0.0052 μM	CA	12.89 μA/μM	107
h-BN	MIP/GQDs/2D-hBN/GCE	EIS	1 pM–10 nM	0.2 pM	SER	30.014 μA/nM	108
MoS <sub>2</sub>	LBA/Au/MoS <sub>2</sub> -PAA/GCE	DPV	100 ag–100 pg/mL	29 ag/mL	LPS		109
MoS <sub>2</sub>	Co@MoS <sub>2</sub> /rGO/SPE	CV	0–1.2 mM	30 nM	Glc	0.945 μA/mM	110
WS <sub>2</sub>	WS <sub>2</sub> /GCE	DPV	5 μM–1 mM	1.2 μM	UA	312 nA/μM cm <sup>2</sup>	111
SnO <sub>2</sub>	SnO <sub>2</sub> nws	DPV	0–13 μM	0.6 μM	RF	0.035 mA/μM	112
CuO	CuO-NPs/GCE	CV	5–600 μM	0.59 μM	Glc	1098.37 μA/mM cm <sup>2</sup>	113
ZnO	ZnONSt@GO	DPV	0.03–670 μM	1.2 nM	MP	16.5 μA/μM cm <sup>2</sup>	114

and its derivatives to detect contaminants in potable water, wastewater, food, and soil. Both adsorption and catalytic efficiency of the sensing material toward the target analyte have a significant impact on the analytical performance of voltammetric and amperometric sensors. The electron-deficient properties of graphene and its derivatives enable them to adsorb and electrocatalytically reduce contaminants as they adsorb electron-deficient nitroaromatic compounds onto their surfaces. In electrochemical sensors, graphene and its derivatives, however, do not perform well on their own. Metal nanoparticles and metal electrodes enhance the electrochemical property and stability of sensors.<sup>22</sup>

**MXene.** In 2019, Gogotsi et. al discovered a group of 2D materials called MXenes that offer outstanding properties such as high electrical conductivity of transition metal nitrides/carbides, high negative zeta potential, functionalized surfaces making MXenes hydrophilic, being ready to bond with various species, and efficient absorption of electromagnetic waves.<sup>83</sup> MXenes are part of the carbide family including transition metal carbide, nitride, and carbonitride. During the etching of MAX phases, MXene is obtained from M<sub>n+1</sub>AX<sub>n</sub>, (n 1, 2, 3) where “M is an early transition metal, A is an element from the A-group (specifically, elements 13–16), and X is carbon or nitrogen”.<sup>84</sup> Since the first MXene sheets were developed by Naguib et al. Hydrofluoric acid (HF) has been widely used as an etching agent.<sup>85</sup> Thus, a strategy of in situ fluorine ion generation is used to delaminate MXene in low-concentrated aqueous media.<sup>86</sup> Using thermal-assisted electrochemical etching methods for MXene synthesis, Ti<sub>3</sub>AlC<sub>2</sub> can be delaminated at room temperature with nontoxic solutions.<sup>87</sup> In turn, this results in more catalytic sites and fewer undesired functional groups when using a beneficial solvent in combination with a green acidic treatment.<sup>88,89</sup> For sensing interfaces, MXene can be functionalized with negative charge groups to perform electrocatalytic functions.<sup>90</sup> A glassy carbon electrode or mono- or bimetallic nanoparticles (Au–Pd) can be coated with Ti<sub>3</sub>C<sub>2</sub>T<sub>x</sub> by drop casting or mixing<sup>91–94</sup> (Table 1).

MXenes hold vast potential for application in energy storing, sensing, catalysis, electromagnetic shielding, and many others. A great deal of their success can be attributed to their high metallic conductivity, and research continues to increase conductivity by modifying the surface chemistry of MXenes.<sup>95</sup> Immobilizing Hb proteins and fabricating mediator-free biosensors have also been explored with nanoscale MXenes.

In addition to having a large surface area, the nano MXenes have more active sites for protein binding.<sup>96</sup> Rakhi et al. demonstrated reliability, reproducibility, and repeatability for their amperometric glucose biosensor. As an enzyme immobilized on Nafion solubilized Au/MXene nanocomposite, glucose oxidase (GOx) enzyme was reduced to hydrogen peroxide (H<sub>2</sub>O<sub>2</sub>) over the glassy carbon electrode (GCE).<sup>97</sup> Graphene-like nanomaterial (MXene-Ti<sub>3</sub>C<sub>2</sub>) for the fabrication of “mediator-free biosensors” has been synthesized and applied to the immobilization of hemoglobin (Hb). Redox proteins have good bioactivity and stability in this matrix that is biocompatible with immobilization. This sensor has a linear range of 0.5–11800 M and a detection limit of 0.12 M.<sup>96</sup> A wearable sensor was constructed by Lei et al. to demonstrate the potential of MXene in sensing.<sup>98</sup> The platform is in the form of wearable wristband biosensor for analyzing sweat as shown in Figure 3a. Poly(3,4-ethylene-dioxythiophene:polystyrenesulfonate) (PEDOT:PSS) solution is a polymer ink having high thermal stability and excellent conductance and can be used to construct wearable biosensors (Figure 3b).<sup>99</sup> However, polyimide can also be used as printable material in combination with molybdenum disulfide (MoS<sub>2</sub>) to fabricate biosensor for endocrine hormone quantification (Figure 3c).<sup>100</sup>

It is still necessary to study new MXenes that are derived from MAX phases. In the past, computations have proven the existence of many MAX phases, but experimental evidence is currently lacking. The nitride-based MXenes have been reviewed only twice to date, making them less explored than other types. Identifying new methods to synthesize nitride based MXenes from different metals is necessary. MXenes’ electrical, thermoelectrical, and magnetic properties must be demonstrated experimentally.<sup>102</sup>

**Transition Metal Dichalcogenides (TMDCs).** In the past few decades, TMDCs (MoS<sub>2</sub>, MoSe<sub>2</sub>, WS<sub>2</sub>, and WSe<sub>2</sub>) have become increasingly popular. They have X–M–X layered structure, wherein M is a transition metal element (3–12 groups) and X is a chalcogen (S, Se, or Te)<sup>115</sup> (Figure 4). TMDCs are abundant and easy to synthesize. In 1923, Linus Pauling identified their structure for the first time.<sup>116</sup> Approximately 60 TMDCs were known by the end of the 1960s, including at least 40 with layered structures.<sup>117</sup> It took until 1986 for the first monolayer MoS<sub>2</sub> suspensions to be produced.<sup>118</sup> Robert Frindt first described the use of adhesive tape for building ultrathin MoS<sub>2</sub> layers in 1963.<sup>119</sup> TMDCs

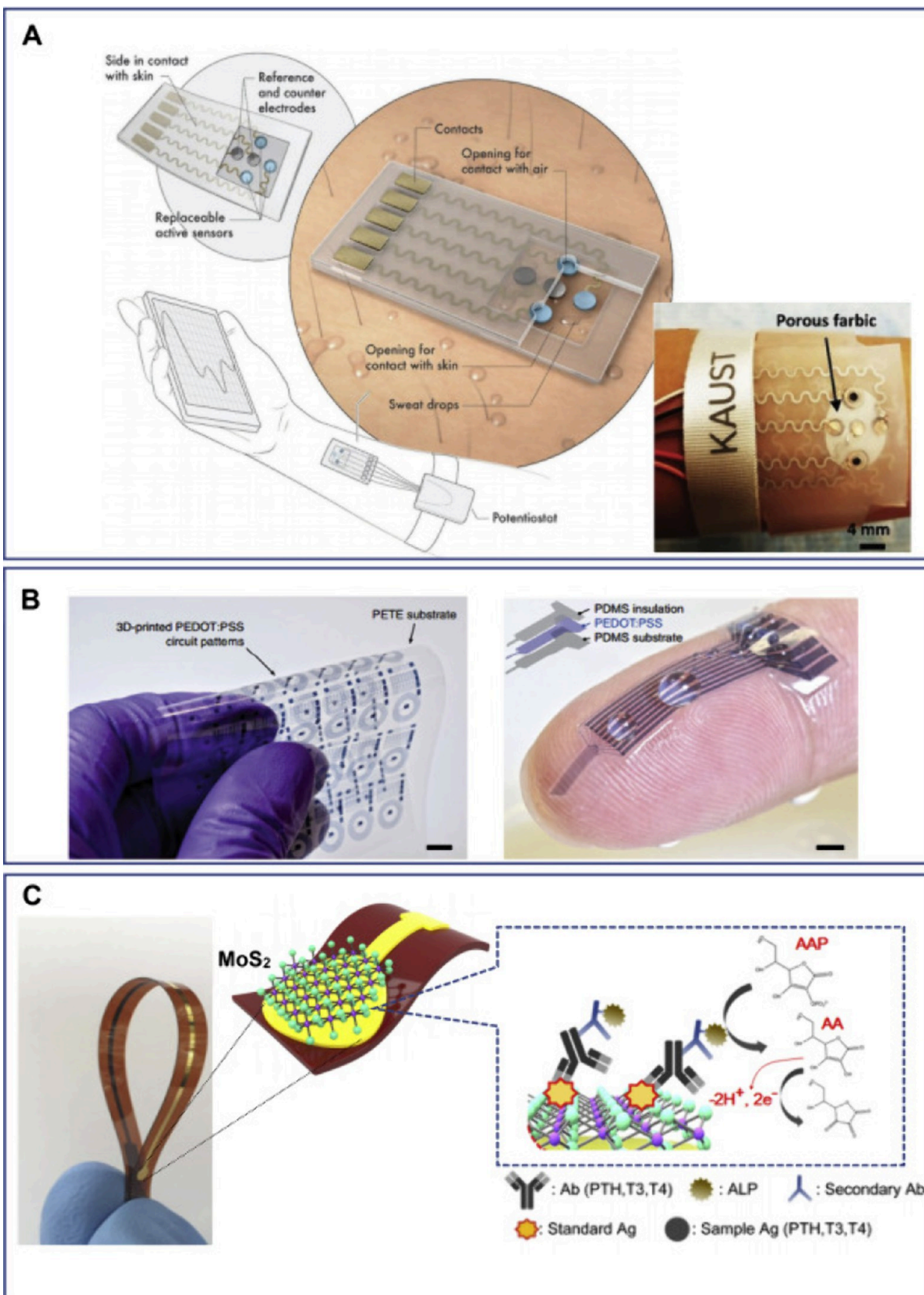

**Figure 3.** (A) MXene-based wristband laminated on human skin as a wearable biosensor.<sup>98</sup> (B) PEDOT:PSS polymer on polyethylene terephthalate (PETE) substrate for 3D printing.<sup>99</sup> (C) Synthesis of MoS<sub>2</sub> on a flexible Au-PI electrode (MoS<sub>2</sub>-Au-polyimide flexible sensor).<sup>100</sup> Reprinted with permission from ref 101. Copyright 2020 KeAi.

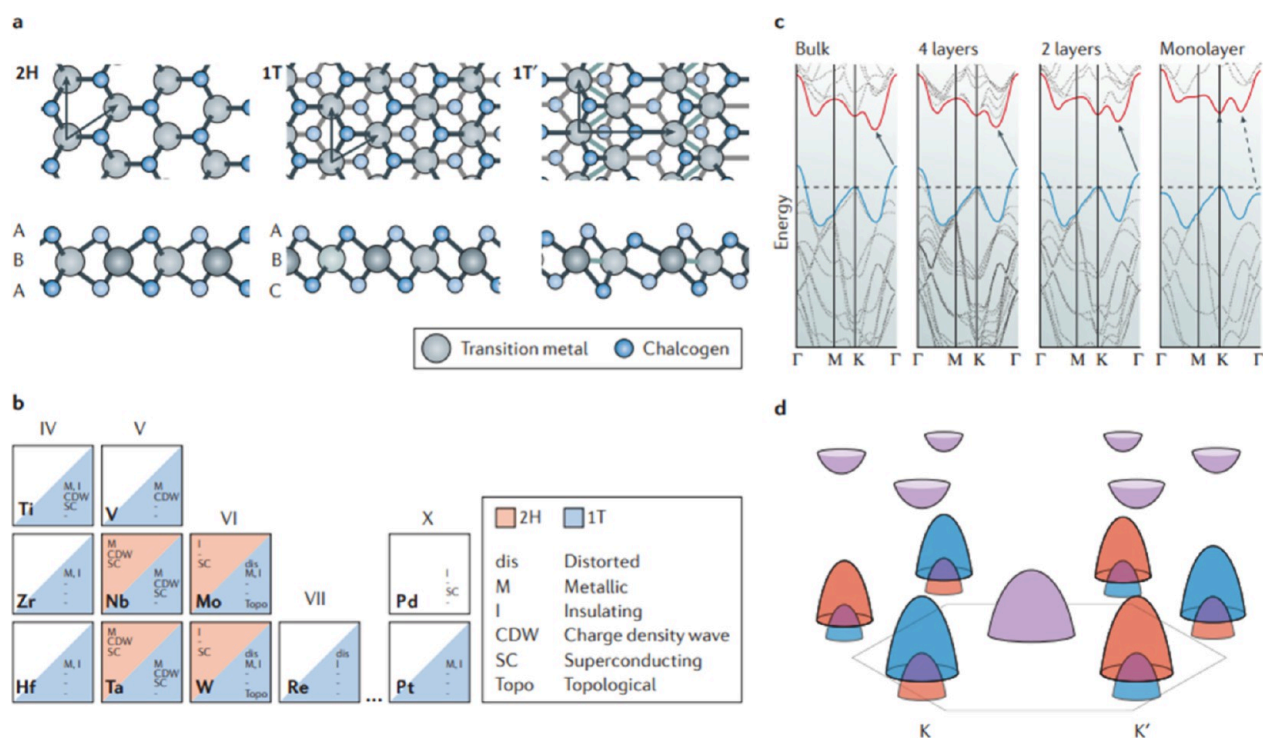

**Figure 4.** Structure and electronic properties of transition metal dichalcogenides (TMDCs). (a) TMDCs with single layer atomic structure. (b) "Periodic table" of known layered TMDCs. (c) Band structure evolution of 2H-MoS<sub>2</sub>. (d) Band structure representation of monolayer 2H-MoS<sub>2</sub>.<sup>122,124</sup> Reprinted with permission from ref 125. Copyright 2017 Springer Nature.

possess various physical and chemical properties such as layer-dependent bandgaps, high-charge mobility, emission of light and absorption.<sup>120</sup>

MoS<sub>2</sub> is one of the most studied materials in this family because of its robustness. There are several features such as direct bandgap, atomic-scale thickness, strong spin-orbit coupling, and favorable electronic and mechanical properties that make TMDCs attractive for fundamental studies and for applications in sensing, actuation, energy harvesting, high-end electronics, spintronics, flexible electronics, optoelectronics, DNA sequencing, and personalized medicine. Radisavljevic et al. demonstrated the first 2D TMDC,<sup>121</sup> and Splendiani et al. showed strong photoluminescence in MoS<sub>2</sub> monolayers,<sup>122,123</sup> which sparked a resurgence in interest in the field.

## METHODS IN ELECTROCHEMICAL SENSING

Electrochemical impedance spectroscopy (EIS) has great potential for analyte detection, but its application has been limited. Voltammetry, amperometry, and potentiometry are the most widely applicable electrochemical techniques for analyte detection.<sup>126</sup>

**Voltammetric.** It was Jaroslav Heyrovsky who discovered voltage metering in the 1920s. Voltammetric methods measure current at multiple potentials in current voltage curves, as opposed to the constant potential in amperometric methods. The cyclic voltameter (CV), the differential pulse voltameter (DPV), the square wave voltameter (SWV), linear sweep voltammetry (LSV), and stripping voltameter are among the voltammetric procedures. Because of their high accuracy and sensitivity, it has been regarded as one of the most well-known tools for determining the trace concentrations of critical contaminants.<sup>127</sup>

As a result of the development of modified electrodes, modern voltammetric techniques have become increasingly influential, leading to an increase in preconcentration, catalytic effects, and a decrease in interferers, providing a viable alternative to electrochemical sensors.<sup>128</sup> The concept of voltammetry is a collection of electroanalytical techniques in which the analyte's properties are obtained by measuring current flow through a polarized WE with a potential difference applied to the WE. We can define a predetermined WE potential based on REF by forcing it to adhere to a predetermined waveshape and measure the current based on that potential or time.<sup>129</sup> Current measurements through an electrode are used to determine voltammetric potentials, which are applied continuously to a solution. To determine the nature of redox reactions in a solution, cyclic voltammetry (CV) is the most popular continuous wave technique. A multitude of applications are possible with this strategy, despite its lack of sensitivity compared with pulse techniques. Chen and Shah used CV most often for determining formal potentials, electron transfer, and electron transfer kinetics, in addition to oxidation/reduction mechanisms.<sup>130</sup>

A measurable potential, charge, phase, or frequency alteration is produced at the working electrolyte interface in an electrochemical reaction, as shown in Figure 5A. It depicts a classic electrochemical cell (Figure 5B) consisting of the "counter electrode, the reference electrode, and the working electrode (WE, RE, and CE)". Anodic stripping voltammetry, an electrochemical process, is used to demonstrate electrode circuit fabrication in different ways as alternatives to traditional solid electrodes, including roll-to-roll fabrication, pad printing, and screen printing. These techniques reduce production costs and allow laboratory-in-field experiments to be performed.<sup>132–135</sup> Purushothama et al. developed a sensitive electrochemical sensor by using pencil graphite electrode for

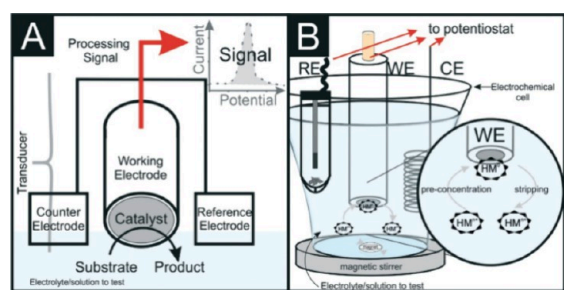

**Figure 5.** (A) Electrochemical sensing representation. (B) Voltammetry through classical electrochemical cell. Reprinted with permission from ref 131. Copyright 2020 Royal Society of Chemistry.

the detection of chlorpromazine (CPZ). The anodic behavior of CPZ was studied by “differential pulse voltammetry” (DPV) and “cyclic voltammetry” (CV). A LOD of 0.03  $\mu\text{M}$  and a linear range of 0.01–0.08  $\mu\text{M}$  were achieved by the developed sensor. In another work, a nanosized hydroxyapatite (NHAP) modified glassy carbon electrode was used for the sensitive detection of  $\text{Pb}^{2+}$  ions in the real water samples by anodic stripping voltammetry. The sensor constructed has a linear range of 5.0 nM to 0.8  $\mu\text{M}$  and LOD of 1.0 nM.<sup>136</sup>

**Potentiometric.** The potential difference between two electrodes is measured using potentiometric sensors when there is no flow of current between them. As a result, the analytical quantity of interest, typically analyte concentration, can be determined from the measured potential (Figure 6).<sup>137</sup>

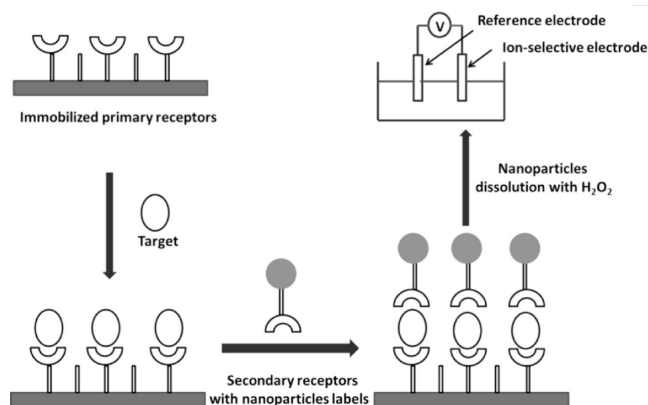

**Figure 6.** Schematic to show the role of nanoparticles as labels in potentiometric biosensors. Reprinted with permission from ref 140. Copyright 2013 Elsevier.

A variety of analytes can be monitored in situ or ex situ using potentiometric sensors, which are gaining tremendous attention as monitoring platforms for measurement of analytes in complex samples matrices. The most common use of potentiometric sensors is for monitoring pH changes, but they are also useful for other fields, such as food quality assurance, environmental monitoring, and water quality assessment.<sup>138</sup> Ngeontae et al. used silver nanoparticles (AgNPs) to construct an electrochemical glucose biosensor based on potentiometric redox markers. By oxidizing AgNPs to free  $\text{Ag}^+$  ions with the product of the glucose oxidase enzyme–substrate reaction,  $\text{H}_2\text{O}_2$  can be detected by an  $\text{Ag}^+$  ion selective electrode (ISE) and used as a measure of glucose concentration. The proposed sensor has shown good repeatability and reproducibility for glucose detection, with a LOD of  $1.0 \times 10^{-5}$  M.<sup>139</sup>

**Impedimetric.** Electrochemical impedance spectroscopy (EIS) has been used for various applications such as pathogen detection. In EIS sensing, a sinusoidal direct current voltage is applied at a particular or a range of frequencies to determine the electrical impedance of an electrode/electrolyte interface. According to Radhakrishnan and Poltroneiri, the target is quantified based on the impedance at the interface when it is bound to the recognition probes on electrode.<sup>141</sup> Recognition probes include antibodies,<sup>142</sup> aptamers,<sup>141</sup> RNAs,<sup>143</sup> and polymers.<sup>144</sup> A recent study<sup>145–147</sup> shows that nanotubes and nanoparticles can be combined in EIS biosensors.<sup>148</sup> The authors Yang et al. reported a novel multifunctional sensor that simultaneously detects, eliminates, and inactivates bacteria. The sensing element is composed of an array of zinc oxide nanorods decorated with silver nanoparticles (AgNPs). Vancomycin was functionalized onto the platform to recognize specific strains of *Staphylococcus aureus*. The sensor demonstrated an excellent antibacterial activity (99.99%), eliminating bacteria at low concentrations by 50%, possibly due to a synergistic germicidal effect of the antibacterial AgNPs and vancomycin.<sup>147</sup>

## ■ FIELDS OF USABILITY

Electrochemistry forms the basis of technologies such as photovoltaics, batteries, and fuel cells that play an important role in the everyday lives of countless people. Equally, it is undeniable that electrochemical glucose biosensors have dramatically improved the lives of hundreds of millions of diabetic individuals worldwide.<sup>149</sup> For the determination of electrolytes and blood gases in hospitals, electrochemical sensors are incorporated into automated clinical analyzers. Similarly, chemistry laboratories commonly use potentiometric pH sensors. A few key emerging applications of electrochemical sensors are discussed below.

**Heavy Metal Detection.** In recent years, human activities have resulted in an increase in heavy metal (HM) ion pollution in water, which in turn is affecting human health. Chromatography, mass spectrometry, atomic absorption spectroscopy, and fluorescence spectroscopy are currently used to detect heavy metal ions in water. As a result of their complexity, high maintenance costs, and reliance on highly skilled operators, these detection methods are not well suited to on-site inspections done frequently. In comparison, electrochemical sensors such as electronic tongues<sup>150</sup> offer high sensitivity, lower cost, and accurate measurements in a short time.

It is currently possible to detect HM in biological samples using colorimetric kits available commercially, but this requires the use of reagents.<sup>151</sup> Electrochemical methods are often reagentless and hence are most suited to analyze HM in situ (Figure 7).<sup>152–154</sup> Furthermore, they are small, simple to install, inexpensive, and allow for the detection of multiple elements. In addition to the ability to detect multiple heavy metal ions simultaneously ( $\text{Ti}^+$ ,  $\text{Pb}^{2+}$ , and  $\text{Hg}^{2+}$ ), graphene-based electrodes have been demonstrated to be effective for the detection of light metal ions.<sup>155</sup> A LOD of  $3.86 \times 10^{-10}$  mol  $\text{L}^{-1}$  ( $\text{Hg}^{2+}$ ),  $4.50 \times 10^{-10}$  mol  $\text{L}^{-1}$  ( $\text{Pb}^{2+}$ ), and  $3.57 \times 10^{-10}$  mol  $\text{L}^{-1}$  ( $\text{Ti}^+$ ) was attained by a graphene composite [2,4- $\text{Cl}_2\text{C}_6\text{H}_3\text{C}(\text{O})\text{CHPPH}_3$ ] (L) and 1-n-octylpyridinium hexafluorophosphate (OPFP), respectively.

**Enzymatic and Nonenzymatic Detection.** Enzymatic and nonenzymatic detection are gaining attention due to their high sensitivity, selectivity, and low limit of detection. For

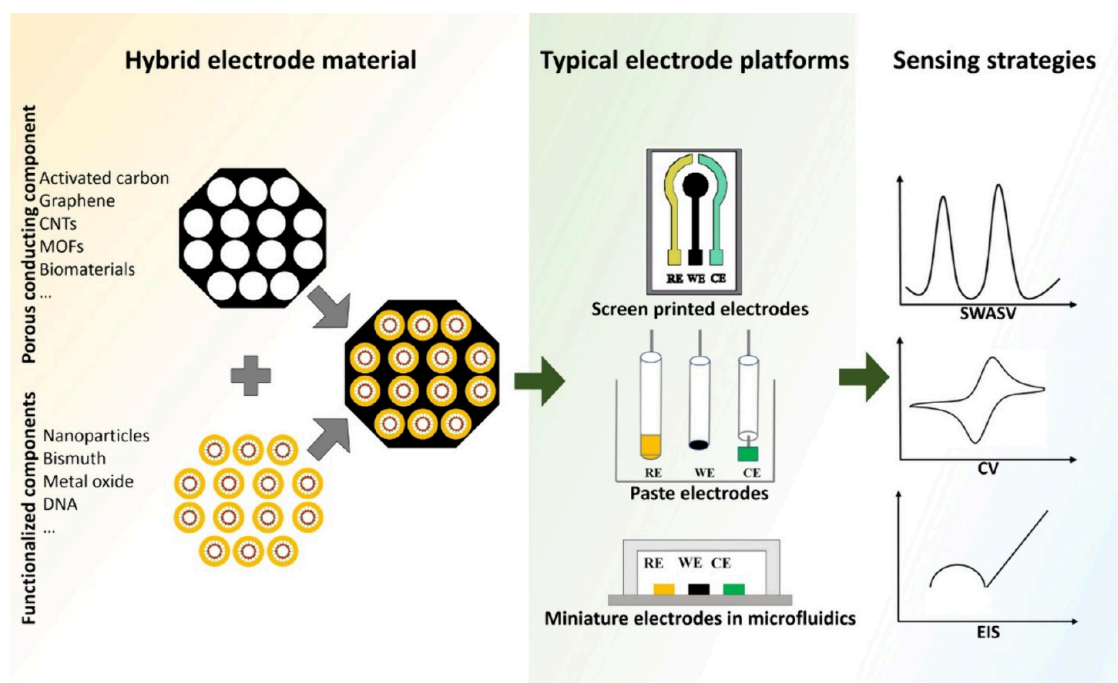

**Figure 7.** Representation of functionalized components and hybrid electrodes with high surface area and superior conductivity due to porous supporting components. Reprinted with permission from ref 156. Copyright 2018 Wiley.

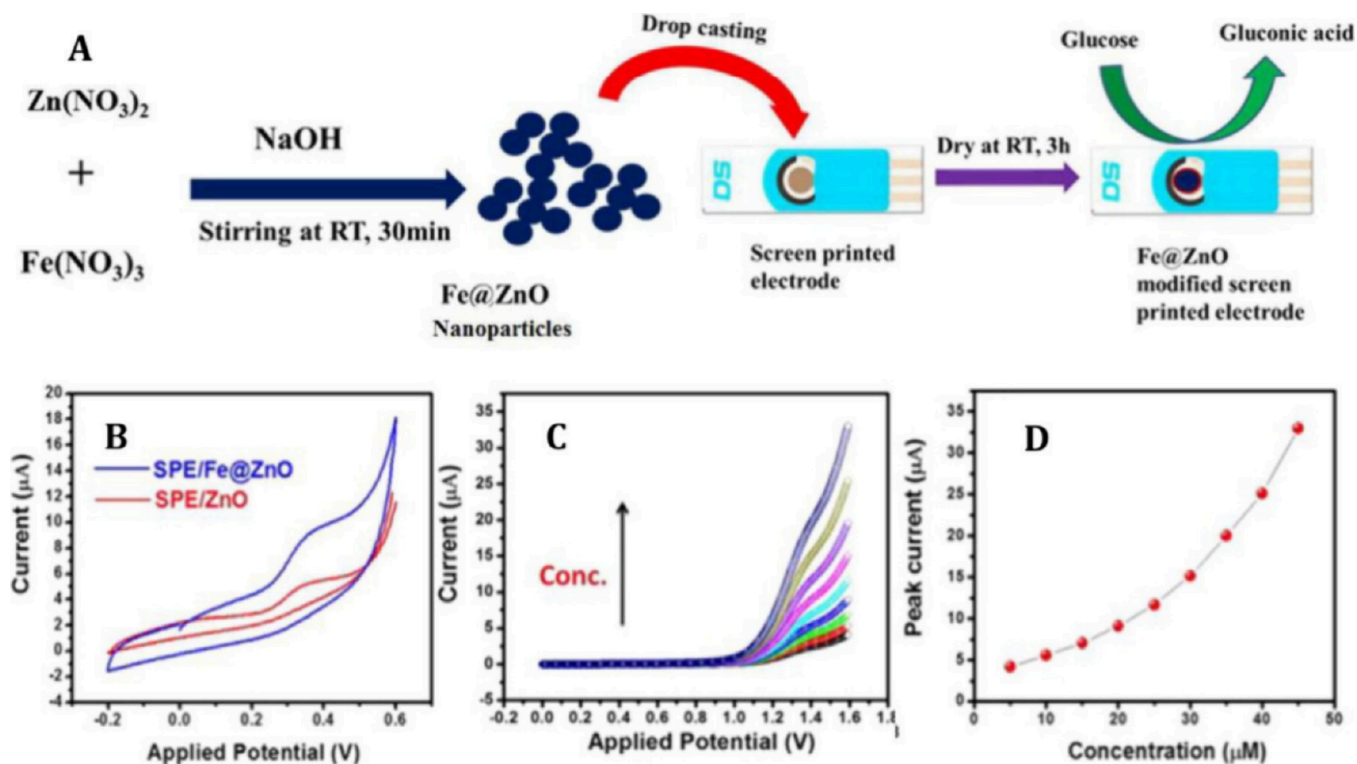

**Figure 8.** (A) Glucose oxidation via fabrication of Fe@ZnO/SPE and Fe@ZnO nanoparticles. (B) Graph showing 15  $\mu\text{M}$  glucose in 0.1 M PBS buffer (pH = 7.4) for cyclic voltammetry of SPE/ZnO and SPE/Fe@ZnO. (C) I–V analysis of glucose in range of 5–45  $\mu\text{M}$  on SPE/Fe@ZnO, and the (D) corresponding calibration curve. Reprinted with permission from ref 164. Copyright 2021 Elsevier.

glucose electrochemical sensors, enzymatic sensors use enzymes for direct reaction with glucose leading to electron transfer, whereas nonenzymatic sensors cause direct oxidation of glucose. In the 1960s, Clark and Updike described the first enzymatic electrode and sensor.<sup>157</sup> Their high selectivity and excellent sensitivity have made them the most extensively

studied sensors in the past few years. For the enzymatic detection of abscisic acid (AA), some chemically-modified electrodes immobilized with enzymes such as “glutaric dialdehyde-nylon semipermeable membrane @ polyethylene membrane layer of the oxygen electrode,<sup>158</sup> 3-glycidioxypropyl-trimethoxysilane (GPTS)-ZnO nanorods modified gold



electrode,<sup>159</sup> screen-printed electrode modified with poly-(ethylene glycol)-400 and diglycidyl ether<sup>160</sup> eggshell membrane<sup>161</sup> were synthesized and evaluated. Shortcomings of enzymatic sensors include tedious immobilization procedures and enzyme denaturation at high temperature and pH. As a result, enzyme sensors can be short-lived and unstable if enzymes are not properly immobilized. Challenges associated with enzymatic sensors can be minimized by adopting a novel detection scheme without enzymes. In AA detection, conducting polymers, metal oxides/hydroxides, transition metals, noble metal nanoparticles, and carbon-based metal nanocomposites can be utilized for the modification of electrodes.<sup>162</sup>

Using a drop-cast method, for nonenzymatic glucose sensing, Fe@ZnO ceramic composites have recently been synthesized and applied to a screen-printed electrode at pH 7.4 (Figure 8A). Raza and Ahmad achieved a LOD of 0.30 M and demonstrated good selectivity against ascorbic acid, uric acid, and dopamine.<sup>163</sup> Figure 8B represents the confirmation of Fe's role at neutral pH for improvement in glucose detection by cyclic voltammetry when SPE/ZnO is used in conjunction with Fe@ZnO. Figure 8C and D show I–V curves for different concentrations of glucose and the corresponding calibration curve.

**Antibiotic Detection.** Antibiotics are important in treating and preventing various diseases in animals and humans.<sup>165</sup> It has been found that when antibiotics prevail in water, environment, and food,<sup>166</sup> they can have ill health effects. It is therefore highly beneficial to monitor their level in the environment and food. Jakubec et al. prepared a Fe<sub>3</sub>O<sub>4</sub>–CMC@Au (carboxy methyl cellulose)-based electrochemical sensor for the sensitive detection of antibiotic chloramphenicol in human urine samples. The developed sensor is economical, simple, and rapid and shows a recovery rate of 97%. Bacterial infections can be treated by Ofloxacin drug.<sup>167</sup> However, trace levels of ofloxacin in the environment can cause human intoxication. Therefore, Elfiky et al. prepared a novel sensor by carbon paste electrode blended with oxidized multiwalled CNTs and graphite for ofloxacin detection in pharmaceutical samples and spiked human urine samples. The sensor achieved a LOD of 0.18 nmol L<sup>-1</sup> and 0.24 nmol L<sup>-1</sup>, respectively.<sup>168</sup>

Another sensor using vertically aligned carbon nanotubes is described as a sensitive method of determining levofloxacin. A method was developed for determining “levofloxacin levels in the range of 1.0–10.0 mmol L<sup>-1</sup> using differential pulse voltammetry in phosphate buffer solution”, with LOD of 75.2 nmol L<sup>-1</sup>. Using the proposed sensor, Moraes et al. successfully determined levofloxacin in urine using HPLC procedure that was in total agreement with the sensor's results.<sup>169</sup>

**Pesticide Detection.** To prevent pests and weeds from damaging agricultural produce, pesticides are widely used. There are serious concerns regarding the effects of pesticides on the ecosystem and human health because of their widespread use. Pesticides are considered as potential carcinogens.<sup>170</sup> Pesticides are toxic chemicals which inhibit the “acetyl cholinesterase enzyme system” in eukaryotic cells. Pesticides degrade the neurotransmitter acetylcholine into acetate and choline. A wide array of human illnesses have been linked to pesticide deposits in food items, including short-term and long-term effects with toxicogen consequences.<sup>171,172</sup> A constant monitoring of pesticide exposure and content is necessary due to the high health risks involved.

Recent studies have shown that electrochemical sensors for pesticides detection are becoming increasingly sought-after by researchers.<sup>173,30,174</sup> In addition, on-site detection of pesticides has been made possible by portable instruments, which are not only convenient but also save time without compromising sensitivity and selectivity. The acetylcholinesterase (AChE) biosensor<sup>175–177</sup> is one of the most widely used electrochemical sensors for pesticide detection. There have been several studies using molecularly imprinted polymer-based sensors, and aptasensors.<sup>178,179</sup> It has been reported that the “pesticide aptamer” is frequently immobilized on the surface of the working electrode in electric aptasensors that use polydopamine (PDA).<sup>179</sup> Using the PDA-based electrochemical aptasensor, the target pesticide binds to the immobilized aptamer and creates an electrical response. Aptamers have been immobilized on electrode surfaces with a wide variety of materials. The immobilization of aptamers can be achieved using reduced graphene oxide-silver nanoparticles,<sup>180</sup> reduced graphene oxide/functionalized multiwalled carbon nanotube nanocomposite<sup>181</sup> and polydimethylsiloxane.<sup>182</sup> Immobilization techniques using PDAs are increasingly being used by researchers.<sup>183–185</sup> Li et al. fabricated a glassy carbon electrode (GCE) for the electrochemical detection of carbofuran in tomatoes, consisting of PDA-reduced graphene-gold nanoparticles immobilized with AChE enzyme (PDA@rGO@GNP). Based on their results, the biosensor was found to be electrically conductive and sensitive to carbofuran pesticides.<sup>186</sup> A further study by Ha et al. immobilized AChE enzyme on a GCE using PDA-graphene composite to determine carbaryl pesticide concentrations in water. Carbaryl pesticide residues in water were also detected with good sensitivity.<sup>173</sup> PDA@Fe<sub>3</sub>O<sub>4</sub>-MIP magnetic nanoparticles were prepared by Miao et al. using Fe<sub>3</sub>O<sub>4</sub> magnetic nanoparticles as dummy templates, bisphenol molecules as functional molecules, and dopamine as the functional molecule<sup>183</sup> (Figure 9A). As a result of removing the template from the PDA layer, they found that recognition cavities appeared on the PDA layer and could be used to detect and

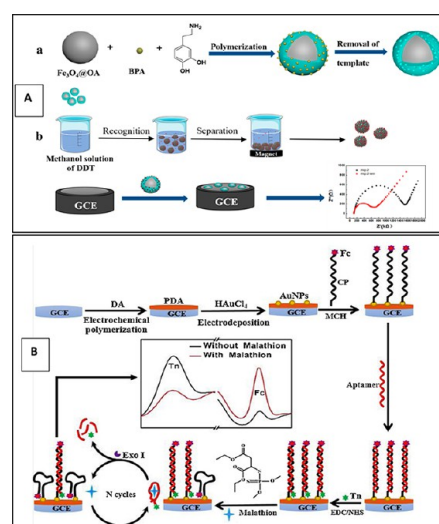

**Figure 9.** Pesticide detection using electrochemical sensors based on (A) magnetic ferroferric oxide/PDA MIP composite. Reprinted with permission from ref 183. Copyright 2020 Elsevier. (B) PDA-Au nanoparticles. Reprinted with permission from ref 184. Copyright 2019 Elsevier.

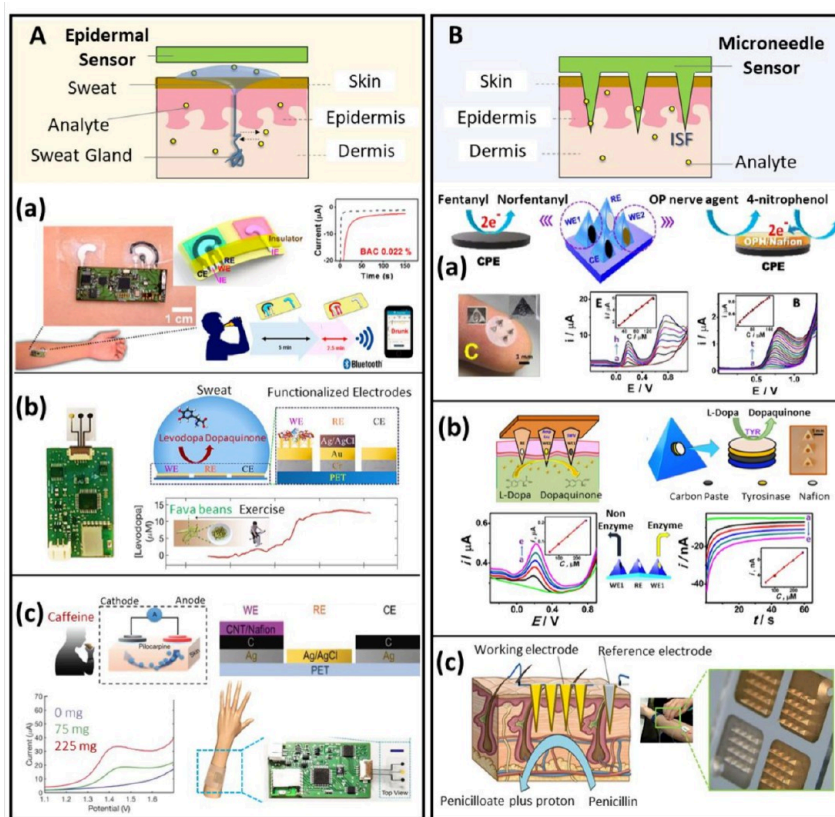

**Figure 10.** Images showing drug analysis through (A) epidermal and (B) microneedle-based electrochemical sensors.<sup>198–203</sup> Reprinted with permission from ref 204. Copyright 2020 The American Chemical Society.

adsorb DDT molecules specifically. When DDT was adsorbing on PDA@Fe<sub>2</sub>O<sub>4</sub>-MIP magnetic nanoparticles, the electrochemical impedance of the nanoparticles increased. In Figure 9B, Xu et al. described the development of an exonuclease amplification and dual signal detection malathion aptasensor based on a PDA.<sup>184</sup>

For malathion, chlorpyrifos, and parathion methyl, “the electrochemical biosensor based on a platinum palladium N-doped carbon shell (PtPd@NCS) nanocomposite showed a detection limit of  $7.9 \times 10^{-15}$  M”.<sup>187</sup> Additionally, using Pt/Zr nanocomposites (Pt@UiO66-NH<sub>2</sub>) in the metal–organic framework, an ultrasensitive biosensor was constructed, with a LOD of  $4.9 \times 10^{-15}$  M for malathion.<sup>188</sup> It was designed to detect paraoxons with an ultrathin disposable biosensor.<sup>92</sup> AChE immobilization and pesticide detection were performed using multidimensional nanocomposites (MXene/Au–Pd), exhibiting a low LOD of 1.75 ng/L.

## CHALLENGES AND ADVANCES IN ELECTROCHEMICAL SENSING

During the past decade, electrode and bioelectrodes materials have been modified for the development of in vivo sensors for the measurement of electrolyte levels.<sup>189–191</sup> Electrochemistry has been demonstrated to be a productive method for the quantification of bacteria and their byproducts, metabolites, enzymes, and various contaminants.<sup>192,193</sup> However, bacterial biosensors have still not made their way to commercialization as a routine monitoring device when compared to glucose sensors that produce global revenue of billions of dollars annually.<sup>194</sup> Commercialization of bacterial biosensors on a large scale requires fulfilling the following requirements: cost

effectiveness, selectivity, low detection limit, precision (5 to 7%), short analysis time (5–10 min), no pre-enrichment method requirement, portable instrumentation, and easy-to-use.<sup>192</sup> Hence, here we have reviewed electrochemical sensors with portable instrumentation because they are ideally suited for wearable and point-of-care applications.

**Wearable Sensors.** The enormous need of on-site real-time drug testing using minimally invasive or noninvasive methods/devices has led to the development of “wearable drug monitoring systems”. For drug measurements, wearable electrochemical devices have become first choice because of their inherent miniaturization, specificity toward electroactive drugs, economical cost, low power requirements, fast fabrication, and their scalability through screen-printing.<sup>195–197</sup> Using sweat stimulation and alcohol detection, Kim et al. developed a flexible tattoo device to monitor sweat alcohol<sup>198</sup> (Figure 10Aa). This is an integrated electrochemical sensor based on AOX enzyme and iontophoretic delivery system and used to deliver pilocarpine. A device for detecting L-Dopa on the epidermis was published by Tai et al., toward management of Parkinson’s disease.<sup>199</sup> Tyrosinase was drop-cast onto an Au/Cr conductive layer and immobilized on a polyethylene terephthalate substrate (flexible) to fabricate an enzymatic electrochemical sensor. A combination of physical exercise and iontophoresis was used to extract sweat from human subjects after consuming fava beans. This methylxanthine-type stimulant was discovered by Tai et al. for coffee consumption and detected using a wristband-type wearable sweat sensor platform<sup>180</sup> (Figure 10Ac).

There has been a considerable recent interest in introducing painless and minimally invasive procedures to collect data rich



**Figure 11.** Image represents glove-based wearable sensors with application and overview in drug detection.<sup>210–213</sup> Reprinted with permission from ref 204. Copyright 2020 The American Chemical Society.

interstitial fluid (ISF) by developing wearable microneedle sensors.<sup>205,206</sup> Using microneedles, many electrochemical sensors have been developed to monitor a range of analytes.<sup>207–209</sup> An electrode transducer is placed on the tip of one or more microneedles along with two electrodes that

correspond to a reference electrode and counter electrode in these minimally invasive devices (Figure 10B). On a platform of a wearable microneedle (Figure 10Ba), when nerve agent sensors and fentanyl were incorporated, an extreme advance sensor has been reported toward continuous minimally invasive

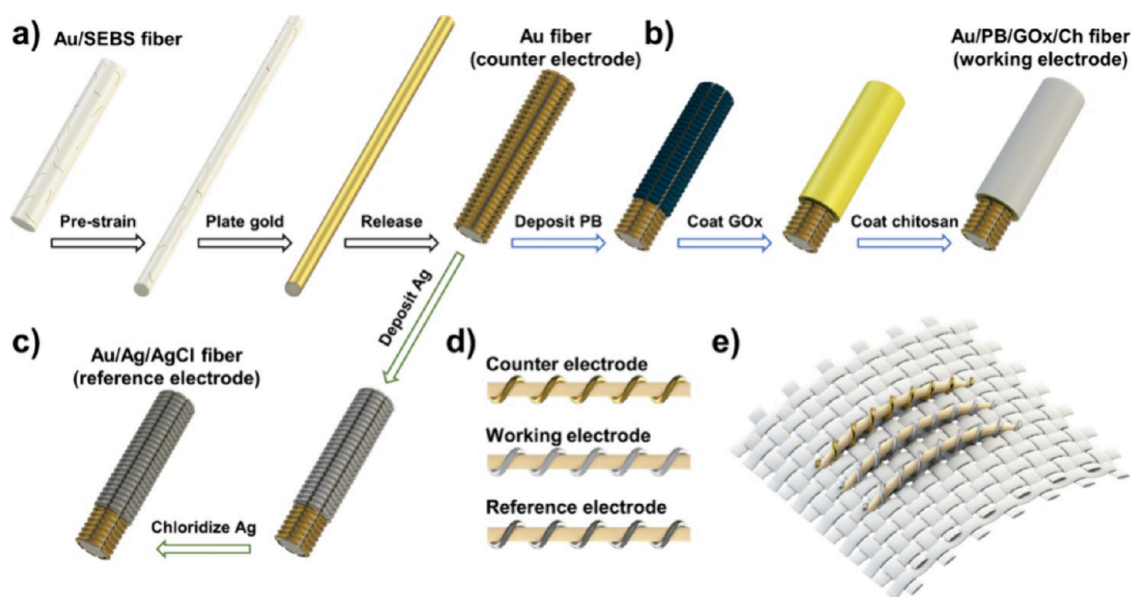

**Figure 12.** Representation of synthetic route of glucose sensor based on stretchable fiber. (a–c) Synthesis of stretchable Au fiber (counter electrode), the Au/PB/Go<sub>x</sub>/Ch fiber (working electrode), and the Au/Ag/AgCl fiber (reference electrode), respectively. (d, e) Glucose sensors integrated into an elastic textile. Reprinted with permission from ref 221. Copyright 2012 Royal Society of Chemistry.

drug detection in multiplexed microneedle-based sensing.<sup>210</sup> In continuing research, for the detection of Parkinson disease, L-Dopa drugs, a strategy based on multimodal microneedle sensing was demonstrated that possess narrow therapeutic ranges. For continual amperometric L-Dopa and SWV detection (Figure 10Bb), “carbon paste-packed hollow microneedle electrodes with and without tyrosinase enzyme modification” are used.<sup>202</sup> It has recently been shown that microneedle-based sensing platforms can be used to monitor “therapeutic drugs in extracellular fluid” (ECF) in real-time, *in vivo*, to optimize the dosage of the antibiotic drug, phenoxymethylpenicillin (Figure 10Bc).<sup>203</sup> By measuring pH changes in localized areas with an “enzyme-modified microneedle electrode”, the microneedle potentiometric sensor measured antibiotic drug reactions.

Although wearable sensors have attracted considerable attention for analysis of biofluids *in situ*, conformal devices have received less attention for screening analytes such as powders and liquids.<sup>214</sup> Countless applicability in the field of forensics, environment, food, and security make it incredibly important to have wearable tools for decentralizing chemical analysis of these materials. Therefore, electrochemical sensors based on wearable gloves can be used to conduct decentralized screening of target analytes using chemical sensing at the fingertips (Figure 11Ai). In contrast to expensive, heavy, and presumptive color tests and spectroscopic tools,<sup>204</sup> the glove-based sensors provide on-site, real time drug screening; however, they are cost-effective, quicker, and user-friendly. During sampling, the serpentine microstructure was unwound to accommodate the strain generated by extreme mechanical deformations (Figure 11Aii). Furthermore, individual fingertip prints can be customized to enable the analysis of numerous analytes simultaneously.<sup>211</sup> It is possible to detect liquids directly with electrochemical wearables (“by dipping the fingertip in the solution”) and powders directly using glove-based wearables (i.e., by using the “swiping method”, which involves sampling and electrochemical steps performed on the “thumb and index fingers”, respectively) (Figure 11Aiv). In this

case, the electrochemical circuit is maintained by covering the index finger with a gel-based electrolyte. For on-site applications, it is imperative to integrate a miniaturized potentiostat (Figure 11Av). On a nitrile fingertip, a screen-printed sensor was synthesized for detecting suspicious powders (Figure 11B). As part of this study, a huge amount of cutting agents was mixed with cocaine samples, including “phenacetin, paracetamol, voverisole, caffeine, lidocaine, procaine, benzocaine, diltiazem, hydroxyzine, boric acid, and sugars”, in order to determine the selectivity of the sensor. Further studies have shown that levamisole suppresses cocaine signal, which has been well described.<sup>212</sup> Fentanyl is one of the most potent synthetic opioids available and is commonly used in illicit drugs. Recently, Barfidokht et al. described a glove-based fentanyl detector that uses fingertip electrodes printed with electrocatalytic oxidation.<sup>213</sup> Ciui et al. developed a multiplexed glove-based device coupled to a robotic arm which can discriminate caffeine from other chemicals in beverages<sup>211</sup> (Figure 11D).

A dynamic and direct reflection of the physiological state of the body can be obtained from heart rate (HR) and blood pressure (BP). It is possible to cause sudden and sometimes lethal alterations to cardiovascular parameters by fluctuations in biomarker levels resulting from movements, stress, food and drink intake, or drug intake.<sup>215</sup> Multidisciplinary sensing modalities can be combined into a single miniaturized skin-conforming wearable device to achieve additional benefits. As an example, critically ill and premature babies must be monitored continuously for a variety of dangerous conditions, including hypoglycemia and sepsis-like infection, as well as open-heart surgery in which their blood pressure and lactate or glucose levels need to be monitored continuously.<sup>216,217</sup> Another amperometric lactic acid sensor developed by Abrar et al. uses silver nanoparticles as a modification for the electrode. A serpentine-crossing silver electrode was immobilized with bovine serum albumin and lactate oxidase was measured.<sup>218</sup> Electrodes with excellent flexibility and bendability can effectively reduce skin impedance. Through

covalent cross-linking, Higson's group immobilized lactate oxidase using highly porous polycarbonate membranes.<sup>219</sup> Lin et al. demonstrated a differential pulse voltammetry-based platform for determining caffeine in sweat. Input and output of three electrodes were provided by a printed circuit board (PCB) mounted on a poly(ethylene terephthalate) (PET) substrate. Using the PCB, caffeine oxidation produced a DPV signal at 1.4 V. At that voltage, caffeine in sweat is quantitatively analyzed with a detection limit of only 3 nM. It is lower than the sweat value (11 M) after caffeine consumption.<sup>220</sup> Other drugs can also be detected using the same technology as caffeine. It is therefore expected that the strategy will be used for detecting other illicit drugs as well.

**Textile-Based Sensors.** Our lives are becoming more and more replete with flexible electronics, ranging from flexible displays to smart clothing. Electrochemical systems must migrate from "rigid and planar substrates to flexible, wearable, and conformal sheets" to be realized as wearable sensing devices. An advanced technology platform must be able to withstand repeated bends and stretches to meet the demands of persistent body-based wearables. The use of such wearable sensors requires that they can maintain their sensing capabilities even when the underlying garment or substrate is subjected to severe mechanical deformation.<sup>221</sup> Using a stretchable three-electrode electrochemical biosensing platform composed of all gold fibers, the study demonstrated how glucose could be detected by enzymes using a wearable glucose detector. Using dry spinning and electroless plating, stretchable gold fibers were prepared successfully.<sup>222,223</sup> As a result of electrodeposition by cyclic voltammetry methods, the fibers were coated with Ag/AgCl thin layer or Prussian blue (PB) (Figure 12). The intrinsic stretch properties of functionalized fibers did not appear to be affected by such coatings. A reference electrode could be made from Au/AgCl-modified fibers, and a working electrode could be made from glucose oxidase (Gox) PB-modified fibers; however, gold fibers acted as counter electrodes. It was also possible to achieve excellent electrochemical performances by winding these fibers around elastic fiber cores under strains of 200%. By monitoring magnitude of glucose in artificial sweat with a high selectivity, it was possible to detect glucose in a highly stretched state.<sup>223</sup>

**Microneedle Sensors.** Rapid development in wearable devices will empower consumers to observe their health conditions at the initial level with the same ease as mobility and vital signs are tracked by smartwatches and cellphones. A microneedle-based transdermal sensor is an ideal candidate with respect to evolving era of wearables to help synergize the prerequisite of "dermal interstitial fluid" (ISF) as a valuable counterpart of clinical indicators with painless skin pricking to enable real-time diagnostics. Microneedle sensing began with the extraction of ISF along with either an on-chip or off-chip instrumentation. In recent years, the focus has shifted toward the assembly of electrochemical biosensors on microneedles' tips to enable direct chemical measurements<sup>224</sup> (Figure 13). According to McAllister et al. microneedles were originally developed to facilitate permeation of drugs through stratum corneum, thus helping to prevent substantial, charged, and/or polar agents from crossing the skin.<sup>225</sup> Beneath the microneedle array, electrochemical electrodes were implemented for glucose detection; however, this array is also used for the detection of passive diffusion of interstitial fluid from human finger. Miller and Narayan demonstrated passive diffusion of interstitial fluid using hollow microneedles.<sup>226</sup> Wearable

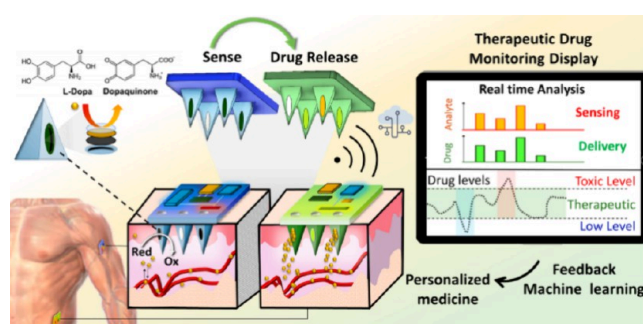

**Figure 13.** For therapeutic drug monitoring in ISF an autonomous L-Dopa system and closed loop autonomous microneedle system is demonstrated toward personalized therapy and optimal therapeutic outcome. Reprinted with permission from ref 204. Copyright 2020 The American Chemical Society.

sensors based on microneedles are currently offering a great deal of promise for tracking a wide range of metabolites, electrolytes, therapeutics, illicit drugs, chemical threats, hormones, proteins, and genes on the body. It is imperative that wearable sensors for real-time, in vivo monitoring of ions are designed and developed because ions play a significant role in the normal functioning of the body and an imbalance in their concentrations can lead to diseases. A recent study by Parilla et al. describes microneedle-based potassium ion sensing that utilizes porosity carbon potentiometric sensors and ISF extraction.<sup>227</sup> Miller et al. developed copper needle-based potassium ion sensing.<sup>228</sup>

**Point of Care Testing (POCT).** Point of care testing (POCT) provides information near the patient rather than sending samples to laboratories, which is time-consuming. To increase the chances of adoption of sensors for POCT, their performance must be tested with "real samples". It is equally important to consider that the acceptance of sensors for POCT is not only reliant on the development of outstanding technology but also on the ability of the technology to address the user needs.<sup>229</sup> Commercial applications of many sensors for POCT are yet to be demonstrated, and they currently remain limited to academic research laboratories.

It can be summarized that the following are the biggest challenges faced when developing electrochemical sensors: (1) attaining a minimum LOD; (2) ensuring that the sensor remains reproducible as well as stable in complex real matrices; and (3) suppressing nonspecific adsorption of interfering species.<sup>230</sup> It is common to use electrochemical sensors to measure a wide variety of real samples, including urine, blood serum, sweat, saliva, tears, and interstitial fluid.<sup>231–239</sup> As a result of the matrix effect, the sensitivity and recovery values of sensors are reduced, which negatively impacts the detection of a particular analyte. It has been observed that dilution of samples is a common practice among researchers to reduce the effect of interference down to threshold; however, it is viable when trying to nullify the matrix effect. The need to dilute and process samples before detection makes the sensors less attractive for POCT. For effective sensor operation, sample dilution or processing should not be necessary when working with pure real samples like whole blood.<sup>231</sup>

POCT is used to detect diseases before they become widespread, such as "liquid biopsy" for initial diagnosis and infectious diseases to prevent the spread of infections. Detecting biomarkers for many diseases continues to be accomplished through blood testing. Owing to "sample-to-

answer nature” and their ability to target a wide range of biochemical analytes, POCT can provide powerful insights that can help speed up the diagnosis process if chosen wisely. Biomarkers associated with relevant diseases and organ functionality are already being measured with POCT devices. An electrochemical sensor was developed by Miripour et al. to detect sputum samples that contain increased levels of reactive oxygen species (ROS). Using multi-wall carbon nanotubes (MWCNTs) to modify steel needles as sensing, reference, and counter electrodes, these three disposable electrode cells laid down the foundation of sensor.<sup>240</sup> Validation of the results was done by comparing them with clinical diagnoses. Torrente-Rodriuez et al. described RapidPlex, a multiplexed, wireless electrochemical POCT in which SARS-CoV-2 could be detected.<sup>241</sup> In addition to nucleocapsid protein, electrochemically engraved graphene electrodes were used to detect immunoglobulins (IgM) and G (IgG) antibodies, CRP, and viral antigen nucleocapsid protein. Infection with viruses, immune responses, and diseases’ severity could be detected using the pool of biomarkers. Using an integrated Bluetooth module, the data could be easily transferred from the electrochemical sensors to a microcontroller-based potentiostat. Clinical samples of blood and saliva containing COVID-19 positives and negatives were analyzed by using the sensor. It is a pioneering study in diagnosing COVID-19 in POCTs, controlling infection spread, and monitoring disease progression.

The portability and adaptability of POCT in water treatment plants, as well as their use in homes, rivers, seas, and lakes, have further driven their use in water quality control. These POCT support fast analysis of environmental species. Over the past few years, some increased interest has been observed in POCT and monitoring of water quality (MWQ).<sup>242</sup> The use of a nanofiber matrix architecture is elaborated by Chet et al. in the creation of a potential 3D microfluidic (MF) device for measuring POC water quality. Iron ion concentration in water was quantitatively determined by the fabricated MF device in CAT.<sup>243</sup> The device also offers many promising advantages, including the ability to prototype, integrate multimaterials, and produce mass quantities.

## CONCLUSION

This Review provides an insight into the current state of electrochemical sensors. Electrochemical sensors can easily be incorporated into individuals’ daily lives for applications ranging from environmental monitoring to food quality testing to disease diagnosis. With fully integrated sensors and miniaturized electronics, in situ sampling can be realized, signal processing and wireless communication can be implemented, and prompt warning and cloud storage can be enabled. Electrochemical sensors can be utilized to access and analyze biofluid on the surface of the skin or fabric. A true comparison of electrochemical sensors with other sensors should consider several key factors including the ease and cost of modification procedures needed to obtain the required sensitivity and selectivity, the need for pretreatment of samples before analysis, stability, repeatability, and reproducibility. Several 2D materials have been used in the past to fabricate electrochemical sensing platforms with improved properties, and this Review provides an overview of these materials. The review also discusses the analytical performance and potential applications of electrochemical sensors with electrodes made of 2D materials.

The development of electrochemical sensors and biosensors has been ongoing for decades, but the market penetration of these sensors is slow despite the immense advances that have already been achieved. The reasons for this include the need to improve “sample preparation, analysis time, and device sensitivity”. Therefore, fundamental, technical, and mechanistic studies are necessary to accelerate the applicability of electrochemical sensors. These sensors would ultimately be commercialized with innovations in nanostructured materials with higher conductivity, surface area, and stability. In addition, the advancement in novel biorecognition elements possessing high selectivity and stability (e.g., synthetic polymers with glycol groups) will aid in the development of better biosensors. Furthermore, these improvements represent a significant milestone toward the design of cost-effective, portable, and fully automated biosensors that can detect microorganisms quickly both in the laboratory and in-field. At the electrochemical interface, the residence time of analyte limits the sensitivity of sensor despite of higher sensitivity. A great deal of effort needs to be put into increasing mass transport of analytes toward electrochemical interfaces (using microfluidic systems or localized temperature increases) and/or forming a homogeneous distribution of the sample at the electrochemical interface (using nano porous sol-gels and aerogels with conductive surfaces).

Fitbit and Apple Watch have shown commercial success as examples of wearable sensors used in health monitoring; hence, next-generation body monitoring devices can be attributed to microneedle-based sensors. Decentralized home health monitoring and testing based on microneedle-based sensors may be possible in a complete point of care diagnostic system, as other researchers have noted.

## AUTHOR INFORMATION

### Corresponding Authors

**Rimmy Singh** – Department of Applied Science & Humanities, DPG Institute of Technology and Management, Gurugram 122004, India; [orcid.org/0000-0002-1972-8873](https://orcid.org/0000-0002-1972-8873); Phone: +91 9467693919; Email: [rimmysingh250@gmail.com](mailto:rimmysingh250@gmail.com)

**Mona Sharma** – Department of Environmental Studies, Central University of Haryana, Mahendergarh 123031, India; Phone: +91 8588856470; Email: [monasharma.gjust@gmail.com](mailto:monasharma.gjust@gmail.com)

### Authors

**Ruchi Gupta** – School of Chemistry, University of Birmingham, Birmingham B15 2TT, U.K.; [orcid.org/0000-0001-6456-8007](https://orcid.org/0000-0001-6456-8007)

**Deepak Bansal** – JBM Group, Gurugram 122001, India

**Rachna Bhatia** – Department of Environmental Science, Maharshi Dayanand University, Rohtak 124001, India

Complete contact information is available at: <https://pubs.acs.org/10.1021/acsomega.3c08060>

### Notes

The authors declare no competing financial interest.

## ACKNOWLEDGMENTS

The authors are grateful to the Department of Science and Technology, Science and Engineering Research Board (File No. TAR/2022/000650), India for the financial support provided during this work.

## REFERENCES

- (1) Liu, D.; Wang, J.; Wu, L.; Huang, Y.; Zhang, Y.; Zhu, M.; Yang, C.; et al. Trends in miniaturized biosensors for point-of-care testing. *TrAC Trends in Analytical Chemistry* **2020**, *122*, No. 115701.
- (2) Hulanicki, A.; Glab, S.; Ingman, F. O. L. K. E. Chemical sensors: definitions and classification. *Pure and applied chemistry* **1991**, *63* (9), 1247–1250.
- (3) Mollarasouli, F.; Zor, E.; Ozcelikay, G.; Ozkan, S. A. Magnetic nanoparticles in developing electrochemical sensors for pharmaceutical and biomedical applications. *Talanta* **2021**, *226*, No. 122108.
- (4) Feuz, L.; Jonsson, P.; Jonsson, M. P.; Hook, F. Improving the limit of detection of nanoscale sensors by directed binding to high-sensitivity areas. *ACS Nano* **2010**, *4* (4), 2167–2177.
- (5) De Vicente, J.; Lavín, A.; Holgado, M.; Laguna, M. F.; Casquel, R.; Santamaría, B.; Ramírez, Y.; et al. The uncertainty and limit of detection in biosensors for immunoassays. *Measurement Science and Technology* **2020**, *31* (4), No. 044004.
- (6) Banks, C. E.; Killard, T.; Venton, B. J. Introduction to electrochemistry for health applications. *Analytical Methods* **2019**, *11* (21), 2736–2737.
- (7) Sassa, F.; Biswas, G. C.; Suzuki, H. Microfabricated electrochemical sensing devices. *Lab Chip* **2020**, *20* (8), 1358–1389.
- (8) Escarpa, A. Food electroanalysis: Sense and simplicity. *Chem. Rev.* **2012**, *12* (1), 72–91.
- (9) Dincer, C.; Bruch, R.; Costa-Rama, E.; Fernández-Abedul, M. T.; Merkoçi, A.; Manz, A.; Güder, F.; et al. Disposable sensors in diagnostics, food, and environmental monitoring. *Adv. Mater.* **2019**, *31* (30), No. 1806739.
- (10) Huang, Q.; Zhu, Y. Printed Electronics: Printing Conductive Nanomaterials for Flexible and Stretchable Electronics: A Review of Materials, Processes, and Applications (Adv. Mater. Technol. 5/2019). *Advanced Materials Technologies* **2019**, *4* (5), No. 1970029.
- (11) Zhu, C.; Yang, G.; Li, H.; Du, D.; Lin, Y. Electrochemical sensors and biosensors based on nanomaterials and nanostructures. *Analytical chemistry* **2015**, *87* (1), 230–249.
- (12) Hales, S.; Tokita, E.; Neupane, R.; Ghosh, U.; Elder, B.; Wirthlin, D.; Kong, Y. L. 3D printed nanomaterial-based electronic, biomedical, and bioelectronic devices. *Nanotechnology* **2020**, *31* (17), No. 172001.
- (13) Jeerapan, I.; Poorahong, S. flexible and stretchable electrochemical sensing systems: materials, energy sources, and integrations. *J. Electrochem. Soc.* **2020**, *167* (3), No. 037573.
- (14) Alahi, M. E. E.; Mukhopadhyay, S. C. Detection methods of nitrate in water: A review. *Sensors and Actuators A: Physical* **2018**, *280*, 210–221.
- (15) Quesada-González, D.; Merkoçi, A. Nanomaterial-based devices for point-of-care diagnostic applications. *Chem. Soc. Rev.* **2018**, *47* (13), 4697–4709.
- (16) Muniandy, S.; Teh, S. J.; Thong, K. L.; Thiha, A.; Dinshaw, I. J.; Lai, C. W.; Leo, B. F.; et al. Carbon nanomaterial-based electrochemical biosensors for foodborne bacterial detection. *Critical reviews in analytical chemistry* **2019**, *49* (6), 510–533.
- (17) Kant, T.; Shrivastava, K.; Dewangan, K.; Kumar, A.; Jaiswal, N. K.; Deb, M. K.; Pervez, S. Design and development of conductive nanomaterials for electrochemical sensors: a modern approach. *Materials Today Chemistry* **2022**, *24*, No. 100769.
- (18) Ligler, F. S.; Gooding, J. J. Lighting up biosensors: now and the decade to come. *Analytical chemistry* **2019**, *91* (14), 8732–8738.
- (19) Jiang, Z.; Feng, B.; Xu, J.; Qing, T.; Zhang, P.; Qing, Z. Graphene biosensors for bacterial and viral pathogens. *Biosens. Bioelectron.* **2020**, *166*, No. 112471.
- (20) Kim, K.; Lee, C. H.; Park, C. B. Chemical sensing platforms for detecting trace-level Alzheimer's core biomarkers. *Chem. Soc. Rev.* **2020**, *49* (15), 5446–5472.
- (21) Vermisoglou, E.; Panáček, D.; Jayaramulu, K.; Pykal, M.; Frébort, I.; Kolář, M.; Otyepka, M.; et al. Human virus detection with graphene-based materials. *Biosens. Bioelectron.* **2020**, *166*, No. 112436.
- (22) Amali, R. K. A.; Lim, H. N.; Ibrahim, I.; Huang, N. M.; Zainal, Z.; Ahmad, S. A. A. Significance of nanomaterials in electrochemical sensors for nitrate detection: A review. *Trends in Environmental Analytical Chemistry* **2021**, *31*, No. e00135.
- (23) Baig, S. A.; Akhtera, N. A.; Ashfaq, M.; Asi, M. R. Determination of the organophosphorus pesticide in vegetables by high-performance liquid chromatography. *American-Eurasian Journal of Agriculture and Environmental Science* **2009**, *6* (5), 513–519.
- (24) Li, J.; Chen, L.; Wang, X.; Jin, H.; Ding, L.; Zhang, K.; Zhang, H. Determination of tetracyclines residues in honey by on-line solid-phase extraction high-performance liquid chromatography. *Talanta* **2008**, *75* (5), 1245–1252.
- (25) Wu, Y.; Jiao, L.; Xu, W.; Gu, W.; Zhu, C.; Du, D.; Lin, Y. Polydopamine-capped bimetallic AuPt hydrogels enable robust biosensor for organophosphorus pesticide detection. *Small* **2019**, *15* (17), No. 1900632.
- (26) Wang, Y.; Zhao, M.; Ping, J.; Chen, B.; Cao, X.; Huang, Y.; Zhang, H.; et al. Bioinspired design of ultrathin 2D bimetallic metal-organic-framework nanosheets used as biomimetic enzymes. *Adv. Mater.* **2016**, *28* (21), 4149–4155.
- (27) Meng, J.; Shi, C.; Wei, B.; Yu, W.; Deng, C.; Zhang, X. Preparation of Fe<sub>3</sub>O<sub>4</sub>@C@PANI magnetic microspheres for the extraction and analysis of phenolic compounds in water samples by gas chromatography–mass spectrometry. *Journal of Chromatography A* **2011**, *1218* (20), 2841–2847.
- (28) Gao, Y. L.; Sun, P. Determination of five pyrethroid pesticides residue in liquid milk by gas chromatography using multi-walled carbon nanotubes as dispersion solid phase extraction sorbent. *Acta Chromatographica* **2018**, *30* (2), 141–146.
- (29) Nie, D.; Li, P.; Zhang, D.; Zhou, T.; Liang, Y.; Shi, G. Simultaneous determination of nitroaromatic compounds in water using capillary electrophoresis with amperometric detection on an electrode modified with a mesoporous nano-structured carbon material. *Electrophoresis* **2010**, *31* (17), 2981–2988.
- (30) Liu, J.; Jiang, J.; Dou, Y.; Zhang, F.; Liu, X.; Qu, J.; Zhu, Q. A novel chemiluminescent probe for hydrazine detection in water and HeLa cells. *Organic & Biomolecular Chemistry* **2019**, *17* (29), 6975–6979.
- (31) Ghaedi, M.; Ahmadi, F.; Shokrollahi, A. Simultaneous preconcentration and determination of copper, nickel, cobalt and lead ions content by flame atomic absorption spectrometry. *Journal of hazardous materials* **2007**, *142* (1–2), 272–278.
- (32) Maduraiveeran, G.; Jin, W. Nanomaterials based electrochemical sensor and biosensor platforms for environmental applications. *Trends in Environmental Analytical Chemistry* **2017**, *13*, 10–23.
- (33) Hoekstra, R.; Blondeau, P.; Andrade, F. J. Distributed electrochemical sensors: recent advances and barriers to market adoption. *Anal. Bioanal. Chem.* **2018**, *410*, 4077–4089.
- (34) Tan, C.; Cao, X.; Wu, X. J.; He, Q.; Yang, J.; Zhang, X.; Zhang, H.; et al. Recent advances in ultrathin two-dimensional nanomaterials. *Chem. Rev.* **2017**, *117* (9), 6225–6331.
- (35) Novoselov, K. S.; Geim, A. K.; Morozov, S. V.; Jiang, D. E.; Zhang, Y.; Dubonos, S. V.; Firsov, A. A.; et al. Electric field effect in atomically thin carbon films. *science* **2004**, *306* (5696), 666–669.
- (36) Late, D. J.; Huang, Y. K.; Liu, B.; Acharya, J.; Shirodkar, S. N.; Luo, J.; Rao, C. N. R.; et al. Sensing behavior of atomically thin-layered MoS<sub>2</sub> transistors. *ACS Nano* **2013**, *7* (6), 4879–4891.
- (37) Férey, G. Hybrid porous solids: past, present, future. *Chem. Soc. Rev.* **2008**, *37* (1), 191–214.
- (38) Shu, Y.; Li, B.; Chen, J.; Xu, Q.; Pang, H.; Hu, X. Facile synthesis of ultrathin nickel–cobalt phosphate 2D nanosheets with enhanced electrocatalytic activity for glucose oxidation. *ACS Appl. Mater. Interfaces* **2018**, *10* (3), 2360–2367.
- (39) Gao, J.; He, P.; Yang, T.; Wang, X.; Zhou, L.; He, Q.; He, X.; et al. Short rod-like Ni-MOF anchored on graphene oxide nanosheets: A promising voltammetric platform for highly sensitive determination of p-chloronitrobenzene. *J. Electroanal. Chem.* **2020**, *861*, No. 113954.
- (40) Yan, Y.; Bo, X.; Guo, L. MOF-818 metal-organic framework-reduced graphene oxide/multiwalled carbon nanotubes composite for

electrochemical sensitive detection of phenolic acids. *Talanta* **2020**, *218*, No. 121123.

(41) Yin, H.; Zhan, T.; Chen, J.; Wang, L.; Gong, J.; Zhao, S.; Nie, Q.; et al. Polyhedral NiO/C porous composites derived by controlled pyrolysis of Ni-MOF for highly efficient non-enzymatic glucose detection. *Journal of Materials Science: Materials in Electronics* **2020**, *31*, 4323–4335.

(42) Li, W.; Lv, S.; Wang, Y.; Zhang, L.; Cui, X. Nanoporous gold induced vertically standing 2D NiCo bimetal-organic framework nanosheets for non-enzymatic glucose biosensing. *Sens. Actuators, B* **2019**, *281*, 652–658.

(43) Liu, B. Metal–organic framework-based devices: separation and sensors. *J. Mater. Chem.* **2012**, *22* (20), 10094–10101.

(44) Hönicke, I. M.; Senkovska, I.; Bon, V.; Baburin, I. A.; Bönisch, N.; Raschke, S.; Kaskel, S.; et al. Balancing mechanical stability and ultrahigh porosity in crystalline framework materials. *Angew. Chem., Int. Ed.* **2018**, *57* (42), 13780–13783.

(45) Li, H.; Wang, K.; Sun, Y.; Lollar, C. T.; Li, J.; Zhou, H. C. Recent advances in gas storage and separation using metal–organic frameworks. *Mater. Today* **2018**, *21* (2), 108–121.

(46) Li, J. R.; Sculley, J.; Zhou, H. C. Metal–organic frameworks for separations. *Chem. Rev.* **2012**, *112* (2), 869–932.

(47) Campbell, M. G.; Dincă, M. Metal–organic frameworks as active materials in electronic sensor devices. *Sensors* **2017**, *17* (5), 1108.

(48) Majewski, M. B.; Peters, A. W.; Wasielewski, M. R.; Hupp, J. T.; Farha, O. K. Metal–organic frameworks as platform materials for solar fuels catalysis. *ACS Energy Letters* **2018**, *3* (3), 598–611.

(49) Choi, K. M.; Jeong, H. M.; Park, J. H.; Zhang, Y. B.; Kang, J. K.; Yaghi, O. M. Supercapacitors of nanocrystalline metal–organic frameworks. *ACS Nano* **2014**, *8* (7), 7451–7457.

(50) Cohen, S. M. Postsynthetic methods for the functionalization of metal–organic frameworks. *Chem. Rev.* **2012**, *112* (2), 970–1000.

(51) Li, Y.; Li, Y.; Yu, X.; Sun, Y. Electrochemical determination of carbofuran in tomatoes by a concanavalin A (con A) polydopamine (PDA)-reduced graphene oxide (RGO)-gold nanoparticle (GNP) glassy carbon electrode (GCE) with immobilized acetylcholinesterase (AChE). *Anal. Lett.* **2019**, *52* (14), 2283–2299.

(52) Tong, P.; Liang, J.; Jiang, X.; Li, J. Research progress on metal-organic framework composites in chemical sensors. *Critical Reviews in Analytical Chemistry* **2020**, *50* (4), 376–392.

(53) Xu, Y.; Li, Q.; Xue, H.; Pang, H. Metal-organic frameworks for direct electrochemical applications. *Coord. Chem. Rev.* **2018**, *376*, 292–318.

(54) Zhang, W.; Zhang, Z.; Li, Y.; Chen, J.; Li, X.; Zhang, Y.; Zhang, Y. Novel nanostructured MIL-101 (Cr)/XC-72 modified electrode sensor: A highly sensitive and selective determination of chloramphenicol. *Sens. Actuators, B* **2017**, *247*, 756–764.

(55) Zhang, D.; Zhang, J.; Zhang, R.; Shi, H.; Guo, Y.; Guo, X.; Yuan, B.; et al. 3D porous metal-organic framework as an efficient electrocatalyst for nonenzymatic sensing application. *Talanta* **2015**, *144*, 1176–1181.

(56) Zhang, Y.; Bo, X.; Nsabimana, A.; Han, C.; Li, M.; Guo, L. Electrocatalytically active cobalt-based metal–organic framework with incorporated macroporous carbon composite for electrochemical applications. *Journal of materials chemistry A* **2015**, *3* (2), 732–738.

(57) Wang, F.; Hu, J.; Liu, Y.; Yuan, G.; Zhang, S.; Xu, L.; Pang, H.; et al. Turning coordination environment of 2D nickel-based metal-organic frameworks by  $\pi$ -conjugated molecule for enhancing glucose electrochemical sensor performance. *Materials Today Chemistry* **2022**, *24*, No. 100885.

(58) Li, P.; Bai, Y.; Zhang, G.; Guo, X.; Meng, X.; Pang, H. Surface-halogen-introduced 2D NiCo bimetallic MOFs via a modulation method for elevated electrochemical glucose sensing. *Inorganic Chemistry Frontiers* **2022**, *9* (22), 5853–5861.

(59) Kempahanumakkagari, S.; Vellingiri, K.; Deep, A.; Kwon, E. E.; Bolan, N.; Kim, K. H. Metal–organic framework composites as electrocatalysts for electrochemical sensing applications. *Coord. Chem. Rev.* **2018**, *357*, 105–129.

(60) Wang, Y.; Zhao, M.; Ping, J.; Chen, B.; Cao, X.; Huang, Y.; Zhang, H.; et al. Bioinspired design of ultrathin 2D bimetallic metal–organic-framework nanosheets used as biomimetic enzymes. *Adv. Mater.* **2016**, *28* (21), 4149–4155.

(61) Wang, Z.; Liu, T.; Yu, Y.; Asif, M.; Xu, N.; Xiao, F.; Liu, H. Coffee Ring–Inspired Approach toward Oriented Self-Assembly of Biomimetic Murray MOFs as Sweat Biosensor. *Small* **2018**, *14* (45), No. 1802670.

(62) Liu, Y.; Zhang, Y.; Chen, J.; Pang, H. Copper metal–organic framework nanocrystal for plane effect nonenzymatic electro-catalytic activity of glucose. *Nanoscale* **2014**, *6* (19), 10989–10994.

(63) Bai, W.; Li, S.; Ma, J.; Cao, W.; Zheng, J. Ultrathin 2D metal–organic framework (nanosheets and nanofilms)-based x D–2D hybrid nanostructures as biomimetic enzymes and supercapacitors. *Journal of Materials Chemistry A* **2019**, *7* (15), 9086–9098.

(64) Su, C. H.; Kung, C. W.; Chang, T. H.; Lu, H. C.; Ho, K. C.; Liao, Y. C. Inkjet-printed porphyrinic metal–organic framework thin films for electrocatalysis. *Journal of Materials Chemistry A* **2016**, *4* (28), 11094–11102.

(65) Zhou, Y.; Li, C.; Hao, Y.; Ye, B.; Xu, M. Oriented growth of cross-linked metal-organic framework film on graphene surface for non-enzymatic electrochemical sensor of hydrogen peroxide in disinfectant. *Talanta* **2018**, *188*, 282–287.

(66) Cai, G.; Jiang, H. L. A modulator-induced defect-formation strategy to hierarchically porous metal–organic frameworks with high stability. *Angew. Chem., Int. Ed.* **2017**, *56* (2), 563–567.

(67) He, L.; Duan, F.; Song, Y.; Guo, C.; Zhao, H.; Tian, J. Y.; Fang, S. M.; et al. 2D zirconium-based metal-organic framework nanosheets for highly sensitive detection of mucin 1: consistency between electrochemical and surface plasmon resonance methods. *2D Materials* **2017**, *4* (2), No. 025098.

(68) Gan, T.; Li, J.; Li, H.; Liu, Y.; Xu, Z. Synthesis of Au nanorod-embedded and graphene oxide-wrapped microporous ZIF-8 with high electrocatalytic activity for the sensing of pesticides. *Nanoscale* **2019**, *11* (16), 7839–7849.

(69) Shahrokhian, S.; Sanati, E. K.; Hosseini, H. Direct growth of metal-organic frameworks thin film arrays on glassy carbon electrode based on rapid conversion step mediated by copper clusters and hydroxide nanotubes for fabrication of a high performance non-enzymatic glucose sensing platform. *Biosens. Bioelectron.* **2018**, *112*, 100–107.

(70) Wang, H.; Xie, X. Q.; Peng, Y.; Li, J.; Liu, C. S. Self-healing mechanism and bioelectrochemical interface properties of core-shell guanidine-borate hydrogels. *J. Colloid Interface Sci.* **2021**, *590*, 103–113.

(71) Yang, J.; Ye, H.; Zhao, F.; Zeng, B. A novel Cu x O nanoparticles@ ZIF-8 composite derived from core-shell metal–organic frameworks for highly selective electrochemical sensing of hydrogen peroxide. *ACS Appl. Mater. Interfaces* **2016**, *8* (31), 20407–20414.

(72) Xu, J.; Xia, J.; Zhang, F.; Wang, Z. An electrochemical sensor based on metal-organic framework-derived porous carbon with high degree of graphitization for electroanalysis of various substances. *Electrochim. Acta* **2017**, *251*, 71–80.

(73) Liu, C. S.; Li, J.; Pang, H. Metal-organic framework-based materials as an emerging platform for advanced electrochemical sensing. *Coord. Chem. Rev.* **2020**, *410*, No. 213222.

(74) Wu, S.; He, Q.; Tan, C.; Wang, Y.; Zhang, H. Graphene-based electrochemical sensors. *small* **2013**, *9* (8), 1160–1172.

(75) Huang, X.; Yin, Z.; Wu, S.; Qi, X.; He, Q.; Zhang, Q.; Zhang, H.; et al. Graphene-based materials: synthesis, characterization, properties, and applications. *small* **2011**, *7* (14), 1876–1902.

(76) Bagheri, H.; Afkhami, A.; Khoshshafar, H.; Rezaei, M.; Sabounchei, S. J.; Sarlakifar, M. Simultaneous electrochemical sensing of thallium, lead and mercury using a novel ionic liquid/graphene modified electrode. *Anal. Chim. Acta* **2015**, *870*, 56–66.

(77) Qi, S.; Zhao, B.; Tang, H.; Jiang, X. Determination of ascorbic acid, dopamine, and uric acid by a novel electrochemical sensor based on pristine graphene. *Electrochimica Acta* **2015**, *161*, 395–402.



- (78) Xu, Y.; Sheng, K.; Li, C.; Shi, G. Highly conductive chemically converted graphene prepared from mildly oxidized graphene oxide. *J. Mater. Chem.* **2011**, *21* (20), 7376–7380.
- (79) Si, Y.; Samulski, E. T. Synthesis of water soluble graphene. *Nano Lett.* **2008**, *8* (6), 1679–1682.
- (80) Dhara, K.; Stanley, J.; Ramachandran, T.; Nair, B. G.; TG, S. B. Pt-CuO nanoparticles decorated reduced graphene oxide for the fabrication of highly sensitive non-enzymatic disposable glucose sensor. *Sens. Actuators, B* **2014**, *195*, 197–205.
- (81) Zhang, Y.; Park, S. J. Bimetallic AuPd alloy nanoparticles deposited on MoO<sub>3</sub> nanowires for enhanced visible-light driven trichloroethylene degradation. *J. Catal.* **2018**, *361*, 238–247.
- (82) Zhang, Y.; Park, S. J. Facile construction of MoO<sub>3</sub>@ ZIF-8 core-shell nanorods for efficient photoreduction of aqueous Cr (VI). *Applied Catalysis B: Environmental* **2019**, *240*, 92–101.
- (83) Naguib, M.; Kurtoglu, M.; Presser, V.; Lu, J.; Niu, J.; Heon, M.; Barsoum, M. W.; et al. Two-dimensional nanocrystals produced by exfoliation of Ti<sub>3</sub>AlC<sub>2</sub>. *Advanced materials* **2011**, *23* (37), 4248–4253.
- (84) Radovic, M.; Barsoum, M. W. MAX phases: bridging the gap between metals and ceramics. *American Ceramics Society Bulletin* **2013**, *92* (3), 20–27.
- (85) Naguib, M.; Mashtalir, O.; Carle, J.; Presser, V.; Lu, J.; Hultman, L.; Barsoum, M. W.; et al. Two-dimensional transition metal carbides. *ACS Nano* **2012**, *6* (2), 1322–1331.
- (86) Wang, X. Y.; Chen, Y.; Mei, L. P.; Wang, A. J.; Yuan, P. X.; Feng, J. J. Confining signal probe in porous PdPtCoNi@ Pt-skin nanopolyhedra to construct a sandwich-type electrochemical immunosensor for ultrasensitive detection of creatine kinase-MB. *Sens. Actuators, B* **2020**, *315*, No. 128088.
- (87) Cao, Y.; Guo, C.; Zou, Y. Rapid synthesis of MXenes at room temperature. *Mater. Sci. Technol.* **2019**, *35* (15), 1904–1907.
- (88) Venkateshalu, S.; Grace, A. N. MXenes—A new class of 2D layered materials: Synthesis, properties, applications as supercapacitor electrode and beyond. *Applied Materials Today* **2020**, *18*, No. 100509.
- (89) Cao, M. S.; Cai, Y. Z.; He, P.; Shu, J. C.; Cao, W. Q.; Yuan, J. 2D MXenes: electromagnetic property for microwave absorption and electromagnetic interference shielding. *Chemical Engineering Journal* **2019**, *359*, 1265–1302.
- (90) Soomro, R. A.; Jawaid, S.; Zhu, Q.; Abbas, Z.; Xu, B. A mini-review on MXenes as versatile substrate for advanced sensors. *Chin. Chem. Lett.* **2020**, *31* (4), 922–930.
- (91) Wu, D.; Wu, M.; Yang, J.; Zhang, H.; Xie, K.; Lin, C. T.; Fu, L.; et al. Delaminated Ti<sub>3</sub>C<sub>2</sub>T<sub>x</sub> (MXene) for electrochemical carbendazim sensing. *Mater. Lett.* **2019**, *236*, 412–415.
- (92) Zhao, F.; Yao, Y.; Jiang, C.; Shao, Y.; Barceló, D.; Ying, Y.; Ping, J. Self-reduction bimetallic nanoparticles on ultrathin MXene nanosheets as functional platform for pesticide sensing. *Journal of hazardous materials* **2020**, *384*, No. 121358.
- (93) Rasheed, P. A.; Pandey, R. P.; Jabbar, K. A.; Ponraj, J.; Mahmoud, K. A. Sensitive electrochemical detection of l-cysteine based on a highly stable Pd@ Ti<sub>3</sub>C<sub>2</sub>T<sub>x</sub> (MXene) nanocomposite modified glassy carbon electrode. *Analytical Methods* **2019**, *11* (30), 3851–3856.
- (94) Lv, X.; Pei, F.; Feng, S.; Wu, Y.; Chen, S. M.; Hao, Q.; Lei, W. Facile synthesis of protonated carbon nitride/Ti<sub>3</sub>C<sub>2</sub>T<sub>x</sub> nanocomposite for simultaneous detection of Pb<sup>2+</sup> and Cd<sup>2+</sup>. *J. Electrochem. Soc.* **2020**, *167* (6), No. 067509.
- (95) Khazaei, M.; Ranjbar, A.; Arai, M.; Sasaki, T.; Yunoki, S. Electronic properties and applications of MXenes: a theoretical review. *Journal of Materials Chemistry C* **2017**, *5* (10), 2488–2503.
- (96) Liu, H.; Duan, C.; Yang, C.; Shen, W.; Wang, F.; Zhu, Z. A novel nitrite biosensor based on the direct electrochemistry of hemoglobin immobilized on MXene-Ti<sub>3</sub>C<sub>2</sub>. *Sens. Actuators, B* **2015**, *218*, 60–66.
- (97) Rakhi, R. B.; Nayak, P.; Xia, C.; Alshareef, H. N. Novel amperometric glucose biosensor based on MXene nanocomposite. *Sci. Rep.* **2016**, *6* (1), 36422.
- (98) Lei, Y.; Zhao, W.; Zhang, Y.; Jiang, Q.; He, J. H.; Baeumner, A. J.; Alshareef, H. N.; et al. A MXene-based wearable biosensor system for high-performance in vitro perspiration analysis. *Small* **2019**, *15* (19), No. 1901190.
- (99) Yuk, H.; Lu, B.; Lin, S.; Qu, K.; Xu, J.; Luo, J.; Zhao, X. 3D printing of conducting polymers. *Nat. Commun.* **2020**, *11* (1), 1604.
- (100) Kim, H. U.; Kim, H. Y.; Seok, H.; Kanade, V.; Yoo, H.; Park, K. Y.; Kim, T.; et al. Flexible MoS<sub>2</sub>–polyimide electrode for electrochemical biosensors and their applications for the highly sensitive quantification of endocrine hormones: PTH, T<sub>3</sub>, and T<sub>4</sub>. *Analytical chemistry* **2020**, *92* (9), 6327–6333.
- (101) Fethi, A. Novel materials for electrochemical sensing platforms. *Sensors International* **2020**, *1*, No. 100035.
- (102) Venkateshalu, S.; Grace, A. N. MXenes—A new class of 2D layered materials: Synthesis, properties, applications as supercapacitor electrode and beyond. *Applied Materials Today* **2020**, *18*, No. 100509.
- (103) Han, J.; Fu, R.; Jin, C.; Li, Z.; Wang, M.; Yu, P.; Xie, Y. Highly sensitive detection of trace Hg<sup>2+</sup> via PdNPs/g-C<sub>3</sub>N<sub>4</sub> nanosheet-modified electrodes using DPV. *Microchemical Journal* **2020**, *152*, No. 104356.
- (104) Cao, S.; Zheng, S.; Pang, H. Ultrathin nanosheet-assembled accordion-like Ni-MOF for hydrazine hydrate amperometric sensing. *Microchimica Acta* **2020**, *187*, 1–9.
- (105) Gu, C.; Liu, Y.; Hu, B.; Liu, Y.; Zhou, N.; Xia, L.; Zhang, Z. Multicomponent nanohybrids of nickel/ferric oxides and nickel cobaltate spinel derived from the MOF-on-MOF nanostructure as efficient scaffolds for sensitively determining insulin. *Anal. Chim. Acta* **2020**, *1110*, 44–55.
- (106) Song, H.; Zhao, H.; Zhang, X.; Xu, Y.; Cheng, X.; Gao, S.; Huo, L. 3D hierarchical hollow hydrangea-like Fe<sub>3</sub>@ ε-MnO<sub>2</sub> microspheres with excellent electrochemical performance for dopamine and hydrogen peroxide. *Biosens. Bioelectron.* **2019**, *133*, 250–257.
- (107) Yan, Y.; Bo, X.; Guo, L. MOF-818 metal-organic framework-reduced graphene oxide/multiwalled carbon nanotubes composite for electrochemical sensitive detection of phenolic acids. *Talanta* **2020**, *218*, No. 121123.
- (108) Yola, M. L.; Atar, N. A novel detection approach for serotonin by graphene quantum dots/two-dimensional (2D) hexagonal boron nitride nanosheets with molecularly imprinted polymer. *Appl. Surf. Sci.* **2018**, *458*, 648–655.
- (109) Poshal, B.; Sandhyarani, N. Highly sensitive endotoxin detection using a gold nanoparticle loaded layered molybdenum disulfide-polyacrylic acid nanocomposite. *Analyst* **2020**, *145* (11), 3939–3947.
- (110) Li, X.; Zhang, M.; Hu, Y.; Xu, J.; Sun, D.; Hu, T.; Ni, Z. Screen-printed electrochemical biosensor based on a ternary Co@ MoS<sub>2</sub> r/GO functionalized electrode for high-performance non-enzymatic glucose sensing. *Biomed. Microdevices* **2020**, *22*, 1–8.
- (111) Durai, L.; Kong, C. Y.; Badhulika, S. One-step solvothermal synthesis of nanoflake-nanorod WS<sub>2</sub> hybrid for non-enzymatic detection of uric acid and quercetin in blood serum. *Materials Science and Engineering: C* **2020**, *107*, No. 110217.
- (112) Sharma, A.; Khosla, A.; Arya, S. Synthesis of SnO<sub>2</sub> nanowires as a reusable and flexible electrode for electrochemical detection of riboflavin. *Microchemical Journal* **2020**, *156*, No. 104858.
- (113) Wu, Q.; He, L.; Jiang, Z. W.; Li, Y.; Cao, Z. M.; Huang, C. Z.; Li, Y. F. CuO nanoparticles derived from metal-organic gel with excellent electrocatalytic and peroxidase-mimicking activities for glucose and cholesterol detection. *Biosens. Bioelectron.* **2019**, *145*, No. 111704.
- (114) Manavalan, S.; Veerakumar, P.; Chen, S. M.; Lin, K. C. Three-dimensional zinc oxide nanostars anchored on graphene oxide for voltammetric determination of methyl parathion. *Microchimica Acta* **2020**, *187*, 1–13.
- (115) Huang, Y.; Shi, Y.; Yang, H. Y.; Ai, Y. A novel single-layered MoS<sub>2</sub> nanosheet based microfluidic biosensor for ultrasensitive detection of DNA. *Nanoscale* **2015**, *7* (6), 2245–2249.

- (116) Dickinson, R. G.; Pauling, L. The crystal structure of molybdenite. *J. Am. Chem. Soc.* **1923**, *45* (6), 1466–1471.
- (117) Wilson, J. A.; Yoffe, A. D. The transition metal dichalcogenides discussion and interpretation of the observed optical, electrical and structural properties. *Adv. Phys.* **1969**, *18* (73), 193–335.
- (118) Joensen, P.; Frindt, R. F.; Morrison, S. R. Single-layer mos2. *Materials research bulletin* **1986**, *21* (4), 457–461.
- (119) Frindt, R. F.; Yoffe, A. D. Physical properties of layer structures: optical properties and photoconductivity of thin crystals of molybdenum disulphide. *Proceedings of the Royal Society of London. Series A. Mathematical and Physical Sciences* **1963**, *273* (1352), 69–83.
- (120) Chowdhury, T.; Sadler, E. C.; Kempa, T. J. Progress and prospects in transition-metal dichalcogenide research beyond 2D. *Chem. Rev.* **2020**, *120* (22), 12563–12591.
- (121) Radisavljevic, B.; Radenovic, A.; Brivio, J.; Giacometti, V.; Kis, A. Single-layer MoS<sub>2</sub> transistors. *Nature Nanotechnol.* **2011**, *6* (3), 147–150.
- (122) Splendiani, A.; Sun, L.; Zhang, Y.; Li, T.; Kim, J.; Chim, C. Y.; Wang, F.; et al. Emerging photoluminescence in monolayer MoS<sub>2</sub>. *Nano Lett.* **2010**, *10* (4), 1271–1275.
- (123) Mak, K. F.; Lee, C.; Hone, J.; Shan, J.; Heinz, T. F. Atomically thin MoS<sub>2</sub>: a new direct-gap semiconductor. *Physical review letters* **2010**, *105* (13), No. 136805.
- (124) Pulkin, A.; Yazyev, O. V. Spin-and valley-polarized transport across line defects in monolayer MoS<sub>2</sub>. *Phys. Rev. B* **2016**, *93* (4), No. 041419.
- (125) Manzeli, S.; Ovchinnikov, D.; Pasquier, D.; Yazyev, O. V.; Kis, A. 2D transition metal dichalcogenides. *Nature Reviews Materials* **2017**, *2* (8), 1–15.
- (126) Moorcroft, M. J.; Davis, J.; Compton, R. G. Detection and determination of nitrate and nitrite: a review. *Talanta* **2001**, *54* (5), 785–803.
- (127) Tajik, S.; Beitollahi, H.; Nejad, F. G.; Dourandish, Z.; Khalilzadeh, M. A.; Jang, H. W.; Shokouhimehr, M.; et al. Recent developments in polymer nanocomposite-based electrochemical sensors for detecting environmental pollutants. *Industrial & engineering chemistry research* **2021**, *60* (3), 1112–1136.
- (128) Pizarro, J.; Segura, R.; Tapia, D.; Navarro, F.; Fuenzalida, F.; Aguirre, M. J. Inexpensive and green electrochemical sensor for the determination of Cd (II) and Pb (II) by square wave anodic stripping voltammetry in bivalve mollusks. *Food chemistry* **2020**, *321*, No. 126682.
- (129) Scozzari, A. Electrochemical sensing methods: A brief review. *Algal Toxins: Nature, Occurrence, Effect and Detection* **2008**, 335–351.
- (130) Chen, A.; Shah, B. Electrochemical sensing and biosensing based on square wave voltammetry. *Analytical Methods* **2013**, *5* (9), 2158–2173.
- (131) Garcia-Miranda Ferrari, A.; Carrington, P.; Rowley-Neale, S. J.; Banks, C. E. Recent advances in portable heavy metal electrochemical sensing platforms. *Environmental Science: Water Research & Technology* **2020**, *6* (10), 2676–2690.
- (132) Banks, C. E.; Foster, C. W.; Kadara, R. O.; Foster, C. W.; Kadara, R. O.; Banks, C. E. *Fundamentals of screen-printing electrochemical architectures*; Springer International Publishing, 2016; pp 13–23.
- (133) Willmann, J.; Stocker, D.; Dörsam, E. Characteristics and evaluation criteria of substrate-based manufacturing. Is roll-to-roll the best solution for printed electronics? *Org. Electron.* **2014**, *15* (7), 1631–1640.
- (134) Bae, S.; Kim, H.; Lee, Y.; Xu, X.; Park, J. S.; Zheng, Y.; Iijima, S.; et al. Roll-to-roll production of 30-in. graphene films for transparent electrodes. *Nature Nanotechnol.* **2010**, *5* (8), 574–578.
- (135) Hösel, M.; Søndergaard, R. R.; Angmo, D.; Krebs, F. C. Comparison of fast roll-to-roll flexographic, inkjet, flatbed, and rotary screen printing of metal back electrodes for polymer solar cells. *Adv. Eng. Mater.* **2013**, *15* (10), 995–1001.
- (136) Purushothama, H. T.; Nayaka, Y. A.; Vinay, M. M.; Manjunatha, P.; Yathisha, R. O.; Basavarajappa, K. V. Pencil graphite electrode as an electrochemical sensor for the voltammetric determination of chlorpromazine. *Journal of Science: Advanced Materials and Devices* **2018**, *3* (2), 161–166.
- (137) Picó, Y. *Chemical analysis of food: Techniques and applications*; Academic Press, 2012.
- (138) Cao, B.; Wang, K.; Xu, H.; Qin, Q.; Yang, J.; Zheng, W.; Cui, D.; et al. Development of magnetic sensor technologies for point-of-care testing: Fundamentals, methodologies and applications. *Sensors and Actuators A: Physical* **2020**, *312*, No. 112130.
- (139) Ngeontae, W.; Janrungroatsakul, W.; Maneewattanapinyo, P.; Ekgasit, S.; Aeungmaitrepirom, W.; Tuntulani, T. Novel potentiometric approach in glucose biosensor using silver nanoparticles as redox marker. *Sens. Actuators, B* **2009**, *137* (1), 320–326.
- (140) Yin, T.; Qin, W. Applications of nanomaterials in potentiometric sensors. *TrAC Trends in Analytical Chemistry* **2013**, *51*, 79–86.
- (141) Radhakrishnan, R.; Poltronieri, P. Fluorescence-free biosensor methods in detection of food pathogens with a special focus on *Listeria monocytogenes*. *Biosensors* **2017**, *7* (4), 63.
- (142) Pandey, C. M.; Tiwari, I.; Singh, V. N.; Sood, K. N.; Sumana, G.; Malhotra, B. D. Highly sensitive electrochemical immunosensor based on graphene-wrapped copper oxide-cysteine hierarchical structure for detection of pathogenic bacteria. *Sens. Actuators, B* **2017**, *238*, 1060–1069.
- (143) Henihan, G.; Schulze, H.; Corrigan, D. K.; Giraud, G.; Terry, J. G.; Hardie, A.; Bachmann, T. T.; et al. Label-and amplification-free electrochemical detection of bacterial ribosomal RNA. *Biosens. Bioelectron.* **2016**, *81*, 487–494.
- (144) Golabi, M.; Kuralay, F.; Jager, E. W.; Beni, V.; Turner, A. P. Electrochemical bacterial detection using poly (3-aminophenylboronic acid)-based imprinted polymer. *Biosens. Bioelectron.* **2017**, *93*, 87–93.
- (145) Wu, Y.; Chai, H. Development of an electrochemical biosensor for rapid detection of foodborne pathogenic bacteria. *Int. J. Electrochem. Sci.* **2017**, *12* (5), 4291–4300.
- (146) Moreno-Guzman, M.; Garcia-Carmona, L.; Molinero-Fernandez, A.; Cava, F.; Gil, M. Á. L.; Escarpa, A. Bi-enzymatic biosensor for on-site, fast and reliable electrochemical detection of relevant D-amino acids in bacterial samples. *Sens. Actuators, B* **2017**, *242*, 95–101.
- (147) Yang, Z.; Wang, Y.; Zhang, D. A novel multifunctional electrochemical platform for simultaneous detection, elimination, and inactivation of pathogenic bacteria based on the Vancomycin-functionalised AgNPs/3D-ZnO nanorod arrays. *Biosens. Bioelectron.* **2017**, *98*, 248–253.
- (148) Khan, M. A. R.; Cardoso, A. R. A.; Sales, M. G. F.; Merino, S.; Tomas, J. M.; Rius, F. X.; Riu, J. Artificial receptors for the electrochemical detection of bacterial flagellar filaments from *Proteus mirabilis*. *Sens. Actuators, B* **2017**, *244*, 732–741.
- (149) Teymourian, H.; Barfidokht, A.; Wang, J. Electrochemical glucose sensors in diabetes management: An updated review (2010–2020). *Chem. Soc. Rev.* **2020**, *49* (21), 7671–7709.
- (150) Shimizu, F. M.; Braunger, M. L.; Riul, A., Jr Heavy metal/toxins detection using electronic tongues. *Chemosensors* **2019**, *7* (3), 36.
- (151) Ullah, N.; Mansha, M.; Khan, I.; Qurashi, A. Nanomaterial-based optical chemical sensors for the detection of heavy metals in water: Recent advances and challenges. *TrAC Trends in Analytical Chemistry* **2018**, *100*, 155–166.
- (152) Guerra, O. J.; Eichman, J.; Kurtz, J.; Hodge, B. M. Cost competitiveness of electrolytic hydrogen. *Joule* **2019**, *3* (10), 2425–2443.
- (153) Batley, G. E. Electroanalytical techniques for the determination of heavy metals in seawater. *Marine Chemistry* **1983**, *12* (2–3), 107–117.
- (154) Lu, Y.; Liang, X.; Niyungeko, C.; Zhou, J.; Xu, J.; Tian, G. A review of the identification and detection of heavy metal ions in the environment by voltammetry. *Talanta* **2018**, *178*, 324–338.

- (155) Bagheri, H.; Afkhami, A.; Khoshafar, H.; Rezaei, M.; Sabounchei, S. J.; Sarlakifar, M. Simultaneous electrochemical sensing of thallium, lead and mercury using a novel ionic liquid/graphene modified electrode. *Analytica chimica acta* **2015**, *870*, 56–66.
- (156) Hou, H.; Zeinu, K. M.; Gao, S.; Liu, B.; Yang, J.; Hu, J. Recent advances and perspective on design and synthesis of electrode materials for electrochemical sensing of heavy metals. *Energy & Environmental Materials* **2018**, *1* (3), 113–131.
- (157) Zhai, Y. J.; Li, J. H.; Chu, X. Y.; Xu, M. Z.; Jin, F. J.; Li, X.; Wang, X. H.; et al. MoS<sub>2</sub> microflowers based electrochemical sensing platform for non-enzymatic glucose detection. *J. Alloys Compd.* **2016**, *672*, 600–608.
- (158) Pisoschi, A. M.; Negulescu, G. P.; Pisoschi, A. Ascorbic acid determination by an amperometric ascorbate oxidase-based biosensor. *Rev. Chim. (Bucharest)* **2010**, *61* (4), 339–344.
- (159) Ibupoto, Z. H.; Ali, S. U.; Khun, K.; Willander, M. L-ascorbic acid biosensor based on immobilized enzyme on ZnO nanorods. *Journal of Biosensors and Bioelectronics* **2011**, *2* (3), 1 DOI: 10.4172/2155-6210.1000110.
- (160) Csiffáry, G.; Fütő, P.; Adányi, N.; Kiss, A. Ascorbate oxidase-based amperometric biosensor for L-ascorbic acid determination in beverages. *Food technology and biotechnology* **2016**, *54* (1), 31–35.
- (161) Chauhan, N.; Dahiya, T.; Pundir, C. S.; et al. Fabrication of an amperometric ascorbate biosensor using egg shell membrane bound *Lagenaria siceraria* fruit ascorbate oxidase. *Journal of Molecular Catalysis B: Enzymatic* **2010**, *67* (1–2), 66–71.
- (162) Dhara, K.; Debiprosad, R. M. Review on nanomaterials-enabled electrochemical sensors for ascorbic acid detection. *Analytical biochemistry* **2019**, *S86*, No. 113415.
- (163) Raza, W.; Ahmad, K. A highly selective Fe@ ZnO modified disposable screen printed electrode based non-enzymatic glucose sensor (SPE/Fe@ ZnO). *Mater. Lett.* **2018**, *212*, 231–234.
- (164) Dong, Q.; Ryu, H.; Lei, Y. Metal oxide based non-enzymatic electrochemical sensors for glucose detection. *Electrochim. Acta* **2021**, *370*, No. 137744.
- (165) Zhou, Y.; Mahapatra, C.; Chen, H.; Peng, X.; Ramakrishna, S.; Nanda, H. S. Recent developments in fluorescent aptasensors for detection of antibiotics. *Current Opinion in Biomedical Engineering* **2020**, *13*, 16–24.
- (166) Chen, B.; Ma, M.; Su, X. An amperometric penicillin biosensor with enhanced sensitivity based on co-immobilization of carbon nanotubes, hematein, and  $\beta$ -lactamase on glassy carbon electrode. *Analytica chimica acta* **2010**, *674* (1), 89–95.
- (167) Jakubec, P.; Urbanová, V.; Medříková, Z.; Zbořil, R. Advanced sensing of antibiotics with magnetic gold nanocomposite: Electrochemical detection of chloramphenicol. *Chemistry A European Journal* **2016**, *22* (40), 14279–14284.
- (168) Elfiky, M.; Salahuddin, N.; Hassanein, A.; Matsuda, A.; Hattori, T. Detection of antibiotic Ofloxacin drug in urine using electrochemical sensor based on synergistic effect of different morphological carbon materials. *Microchemical Journal* **2019**, *146*, 170–177.
- (169) Moraes, F. C.; Silva, T. A.; Cesarino, I.; Lanza, M. R.; Machado, S. A. Antibiotic detection in urine using electrochemical sensors based on vertically aligned carbon nanotubes. *Electroanalysis* **2013**, *25* (9), 2092–2099.
- (170) Dasriya, V.; Joshi, R.; Ranveer, S.; Dhundale, V.; Kumar, N.; Raghu, H. V. Rapid detection of pesticide in milk, cereal and cereal based food and fruit juices using paper strip-based sensor. *Sci. Rep.* **2021**, *11* (1), 18855.
- (171) Grewal, A. S. Pesticide Res-idues in Food Grains, Vegetables and Fruits: A Hazard to Human Health. *J. Med. Chem. Toxicol* **2017**, *2* (1), 40.
- (172) Tehri, N.; Kumar, N.; Raghu, H. V.; Vashishth, A. Biomarkers of bacterial spore germination. *Annals of Microbiology* **2018**, *68*, 513–523.
- (173) Ha, T. B.; Le, H. T.; Cao, H. H.; Binh, N. T.; Nguyen, H. L.; Dang, L. H.; Nguyen, V. A.; et al. Electro-immobilization of acetylcholinesterase using polydopamine for carbaryl microsensor. *J. Electron. Mater.* **2018**, *47*, 1686–1693.
- (174) Wu, Q.; Zhuang, X.; Yin, Q.; Zhu, X.; Xiang, Y. Determination of lead, cadmium, chromium, arsenic and mercury in lotus root by inductively coupled plasma mass spectrometry. *Journal of Food Safety and Quality* **2019**, *10* (6), 1715–1721.
- (175) Dhull, V. A. Nafion/ACHe-cSWCNT/MWCNT/Au-based amperometric biosensor for the determination of organophosphorous compounds. *Environmental technology* **2020**, *41*, 566.
- (176) Thakkar, J. B.; Gupta, S.; Prabha, C. R. Acetylcholine esterase enzyme doped multiwalled carbon nanotubes for the detection of organophosphorus pesticide using cyclic voltammetry. *Int. J. Biol. Macromol.* **2019**, *137*, 895–903.
- (177) Yao, Y.; Wang, G.; Chu, G.; An, X.; Guo, Y.; Sun, X. The development of a novel biosensor based on gold nanocages/graphene oxide-chitosan modified acetylcholinesterase for organophosphorus pesticide detection. *New J. Chem.* **2019**, *43* (35), 13816–13826.
- (178) Chen, C.; Shi, J.; Guo, Y.; Zha, L.; Lan, L.; Chang, Y.; Ding, Y. A novel aptasensor for malathion blood samples detection based on DNA-silver nanocluster. *Analytical Methods* **2018**, *10* (16), 1928–1934.
- (179) Madianos, L.; Skotadis, E.; Tsekenis, G.; Patsiouras, L.; Tsigkourakos, M.; Tsoukalas, D. Impedimetric nanoparticle aptasensor for selective and label free pesticide detection. *Microelectron. Eng.* **2018**, *189*, 39–45.
- (180) Shi, X.; Sun, J.; Yao, Y.; Liu, H.; Huang, J.; Guo, Y.; Sun, X. Novel electrochemical aptasensor with dual signal amplification strategy for detection of acetamiprid. *Sci. Total Environ.* **2020**, *705*, No. 135905.
- (181) Arvand, M.; Gholami, J. A label-free electrochemical aptasensor for sensitive edifenphos detection in rice. *Analytical Methods* **2020**, *12* (9), 1237–1243.
- (182) Fu, J.; Dong, H.; Zhao, Q.; Cheng, S.; Guo, Y.; Sun, X. Fabrication of refreshable aptasensor based on hydrophobic screen-printed carbon electrode interface. *Science of The Total Environment* **2020**, *712*, No. 136410.
- (183) Miao, J.; Liu, A.; Wu, L.; Yu, M.; Wei, W.; Liu, S. Magnetic ferromagnetic oxide and polydopamine molecularly imprinted polymer nanocomposites based electrochemical impedance sensor for the selective separation and sensitive determination of dichlorodiphenyl-trichloroethane (DDT). *Anal. Chim. Acta* **2020**, *1095*, 82–92.
- (184) Xu, G.; Hou, J.; Zhao, Y.; Bao, J.; Yang, M.; Fa, H.; Hou, C.; et al. Dual-signal aptamer sensor based on polydopamine-gold nanoparticles and exonuclease I for ultrasensitive malathion detection. *Sens. Actuators, B* **2019**, *287*, 428–436.
- (185) Wu, Y.; Jiao, L.; Xu, W.; Gu, W.; Zhu, C.; Du, D.; Lin, Y. Polydopamine-capped bimetallic AuPt hydrogels enable robust biosensor for organophosphorus pesticide detection. *Small* **2019**, *15* (17), No. 1900632.
- (186) Li, H.; Wang, X.; Wang, Z.; Wang, Y.; Dai, J.; Gao, L.; Li, C.; et al. A polydopamine-based molecularly imprinted polymer on nanoparticles of type SiO<sub>2</sub>@ rGO@ Ag for the detection of  $\lambda$ -cyhalothrin via SERS. *Microchimica Acta* **2018**, *185*, 1–10.
- (187) Berkal, M. A.; Nardin, C. Pesticide biosensors: trends and progresses. *Anal. Bioanal. Chem.* **2023**, *415*, 1–26.
- (188) Ma, L.; He, Y.; Wang, Y.; Wang, Y.; Li, R.; Huang, Z.; Gao, J.; et al. Nanocomposites of Pt nanoparticles anchored on UiO66-NH<sub>2</sub> as carriers to construct acetylcholinesterase biosensors for organophosphorus pesticide detection. *Electrochim. Acta* **2019**, *318*, 525–533.
- (189) Wu, F.; Yu, P.; Mao, L. Bioelectrochemistry for in vivo analysis: Interface engineering toward implantable electrochemical biosensors. *Current Opinion in Electrochemistry* **2017**, *5* (1), 152–157.
- (190) Jalili, R.; Kanneganti, A.; Romero-Ortega, M. I.; Wallace, G. G. Implantable electrodes. *Current Opinion in Electrochemistry* **2017**, *3* (1), 68–74.
- (191) McCaul, M.; Glennon, T.; Diamond, D. Challenges and opportunities in wearable technology for biochemical analysis in sweat. *Current Opinion in Electrochemistry* **2017**, *3* (1), 46–50.

- (192) Ivnitski, D.; Abdel-Hamid, I.; Atanasov, P.; Wilkins, E.; Stricker, S. Application of electrochemical biosensors for detection of food pathogenic bacteria. *Electroanalysis: An International Journal Devoted to Fundamental and Practical Aspects of Electroanalysis* **2000**, *12* (5), 317–325.
- (193) Monzó, J.; Insua, I.; Fernandez-Trillo, F.; Rodriguez, P. Fundamentals, achievements and challenges in the electrochemical sensing of pathogens. *Analyst* **2015**, *140* (21), 7116–7128.
- (194) Newman, J. D.; Turner, A. P. Home blood glucose biosensors: a commercial perspective. *Biosens. Bioelectron.* **2005**, *20* (12), 2435–2453.
- (195) Shaw, L.; Dennany, L. Applications of electrochemical sensors: Forensic drug analysis. *Current Opinion in Electrochemistry* **2017**, *3* (1), 23–28.
- (196) Florea, A.; De Jong, M.; De Wael, K. Electrochemical strategies for the detection of forensic drugs. *Current Opinion in Electrochemistry* **2018**, *11*, 34–40.
- (197) Lima, H. R. S.; da Silva, J. S.; de Oliveira Farias, E. A.; Teixeira, P. R. S.; Eiras, C.; Nunes, L. C. C. Electrochemical sensors and biosensors for the analysis of antineoplastic drugs. *Biosens. Bioelectron.* **2018**, *108*, 27–37.
- (198) Kim, J.; Jeerapan, I.; Imani, S.; Cho, T. N.; Bandodkar, A.; Cinti, S.; Wang, J.; et al. Noninvasive alcohol monitoring using a wearable tattoo-based iontophoretic-biosensing system. *Acs Sensors* **2016**, *1* (8), 1011–1019.
- (199) Tai, L. C.; Gao, W.; Chao, M.; Bariya, M.; Ngo, Q. P.; Shahpar, Z.; Javey, A.; et al. Methylxanthine drug monitoring with wearable sweat sensors. *Adv. Mater.* **2018**, *30* (23), No. 1707442.
- (200) Tai, L. C.; Liaw, T. S.; Lin, Y.; Nyein, H. Y.; Bariya, M.; Ji, W.; Javey, A.; et al. Wearable sweat band for noninvasive levodopa monitoring. *Nano Lett.* **2019**, *19* (9), 6346–6351.
- (201) Mishra, R. K.; Goud, K. Y.; Li, Z.; Moonla, C.; Mohamed, M. A.; Tehrani, F.; Wang, J.; et al. Continuous opioid monitoring along with nerve agents on a wearable microneedle sensor array. *J. Am. Chem. Soc.* **2020**, *142* (13), 5991–5995.
- (202) Goud, K. Y.; Moonla, C.; Mishra, R. K.; Yu, C.; Narayan, R.; Litvan, I.; Wang, J. Wearable electrochemical microneedle sensor for continuous monitoring of levodopa: toward Parkinson management. *ACS sensors* **2019**, *4* (8), 2196–2204.
- (203) Rawson, T. M.; Gowers, S. A.; Freeman, D. M.; Wilson, R. C.; Sharma, S.; Gilchrist, M.; Holmes, A. H.; et al. Microneedle biosensors for real-time, minimally invasive drug monitoring of phenoxymethylpenicillin: a first-in-human evaluation in healthy volunteers. *Lancet Digital Health* **2019**, *1* (7), e335–e343.
- (204) Teymourian, H.; Parrilla, M.; Sempionatto, J. R.; Montiel, N. F.; Barfidokht, A.; Van Echelpoel, R.; Wang, J.; et al. Wearable electrochemical sensors for the monitoring and screening of drugs. *ACS sensors* **2020**, *5* (9), 2679–2700.
- (205) Babity, S.; Roohnikan, M.; Brambilla, D. Advances in the design of transdermal microneedles for diagnostic and monitoring applications. *Small* **2018**, *14* (49), No. 1803186.
- (206) Madden, J.; O'Mahony, C.; Thompson, M.; O'Riordan, A.; Galvin, P. Biosensing in dermal interstitial fluid using microneedle based electrochemical devices. *Sensing and Bio-Sensing Research* **2020**, *29*, No. 100348.
- (207) Mohan, A. V.; Windmiller, J. R.; Mishra, R. K.; Wang, J. Continuous minimally-invasive alcohol monitoring using microneedle sensor arrays. *Biosens. Bioelectron.* **2017**, *91*, 574–579.
- (208) Parrilla, M.; Cuartero, M.; Padrell Sánchez, S.; Rajabi, M.; Roxhed, N.; Niklaus, F.; Crespo, G. A. Wearable all-solid-state potentiometric microneedle patch for intradermal potassium detection. *Analytical chemistry* **2019**, *91* (2), 1578–1586.
- (209) Ventrelli, L.; Marsilio Strambini, L.; Barillaro, G. Microneedles for transdermal biosensing: current picture and future direction. *Adv. Healthcare Mater.* **2015**, *4* (17), 2606–2640.
- (210) Mishra, R. K.; Hubble, L. J.; Martín, A.; Kumar, R.; Barfidokht, A.; Kim, J.; Wang, J.; et al. Wearable flexible and stretchable glove biosensor for on-site detection of organophosphorus chemical threats. *ACS sensors* **2017**, *2* (4), 553–561.
- (211) Ciui, B.; Martin, A.; Mishra, R. K.; Nakagawa, T.; Dawkins, T. J.; Lyu, M.; Wang, J.; et al. Chemical sensing at the robot fingertips: Toward automated taste discrimination in food samples. *ACS sensors* **2018**, *3* (11), 2375–2384.
- (212) De Jong, M.; Slegers, N.; Kim, J.; Van Durme, F.; Samyn, N.; Wang, J.; De Wael, K. Electrochemical fingerprint of street samples for fast on-site screening of cocaine in seized drug powders. *Chemical science* **2016**, *7* (3), 2364–2370.
- (213) Barfidokht, A.; Mishra, R. K.; Seenivasan, R.; Liu, S.; Hubble, L. J.; Wang, J.; Hall, D. A. Wearable electrochemical glove-based sensor for rapid and on-site detection of fentanyl. *Sens. Actuators, B* **2019**, *296*, No. 126422.
- (214) Hubble, L. J.; Wang, J. Sensing at your fingertips: glove-based wearable chemical sensors. *Electroanalysis* **2019**, *31* (3), 428–436.
- (215) Sempionatto, J. R.; Lin, M.; Yin, L.; De la Paz, E.; Pei, K.; Sonsa-Ard, T.; Wang, J.; et al. An epidermal patch for the simultaneous monitoring of haemodynamic and metabolic biomarkers. *Nature Biomedical Engineering* **2021**, *5* (7), 737–748.
- (216) Murković, I.; Steinberg, M. D.; Murković, B. Sensors in neonatal monitoring: Current practice and future trends. *Technology and Health Care* **2003**, *11* (6), 399–412.
- (217) Ho, K. K. Y.; Peng, Y. W.; Ye, M.; Tchouta, L.; Schneider, B.; Hayes, M.; Chen, H.; et al. Evaluation of an anti-thrombotic continuous lactate and blood pressure monitoring catheter in an in vivo piglet model undergoing open-heart surgery with cardiopulmonary bypass. *Chemosensors* **2020**, *8* (3), 56.
- (218) Abrar, M. A.; Dong, Y.; Lee, P. K.; Kim, W. S. Bendable electro-chemical lactate sensor printed with silver nano-particles. *Sci. Rep.* **2016**, *6* (1), 30565.
- (219) Tur-García, E. L.; Davis, F.; Collyer, S. D.; Holmes, J. L.; Barr, H.; Higson, S. P. Novel flexible enzyme laminate-based sensor for analysis of lactate in sweat. *Sens. Actuators, B* **2017**, *242*, 502–510.
- (220) Lin, S.; Yu, W.; Wang, B.; Zhao, Y.; En, K.; Zhu, J.; Emaminejad, S.; et al. Noninvasive wearable electroactive pharmaceutical monitoring for personalized therapeutics. *Proc. Natl. Acad. Sci. U. S. A.* **2020**, *117* (32), 19017–19025.
- (221) Windmiller, J. R.; Bandodkar, A. J.; Valdés-Ramírez, G.; Parkhomovsky, S.; Martínez, A. G.; Wang, J. Electrochemical sensing based on printable temporary transfer tattoos. *Chem. Commun.* **2012**, *48* (54), 6794–6796.
- (222) Zhao, Y.; Dong, D.; Wang, Y.; Gong, S.; An, T.; Yap, L. W.; Cheng, W. Highly stretchable fiber-shaped supercapacitors based on ultrathin gold nanowires with double-helix winding design. *ACS Appl. Mater. Interfaces* **2018**, *10* (49), 42612–42620.
- (223) Zhao, Y.; Zhai, Q.; Dong, D.; An, T.; Gong, S.; Shi, Q.; Cheng, W. Highly stretchable and strain-insensitive fiber-based wearable electrochemical biosensor to monitor glucose in the sweat. *Analytical chemistry* **2019**, *91* (10), 6569–6576.
- (224) Teymourian, H.; Tehrani, F.; Mahato, K.; Wang, J. Lab under the skin: microneedle based wearable devices. *Adv. Healthcare Mater.* **2021**, *10* (17), No. 2002255.
- (225) McAllister, D. V. Microfabricated microneedles, A novel approach to transdermal drug delivery. *In Proc. Int. Symp. Control. Release Bioact. Mater.* **1998**, *25*, 30–31.
- (226) Miller, P. R.; Narayan, R. J.; Polsky, R. Microneedle-based sensors for medical diagnosis. *J. Mater. Chem. B* **2016**, *4* (8), 1379–1383.
- (227) Parrilla, M.; Cuartero, M.; Padrell Sánchez, S.; Rajabi, M.; Roxhed, N.; Niklaus, F.; Crespo, G. A. Wearable all-solid-state potentiometric microneedle patch for intradermal potassium detection. *Analytical chemistry* **2019**, *91* (2), 1578–1586.
- (228) Miller, P. R.; Xiao, X.; Brener, L.; Burckel, D. B.; Narayan, R.; Polsky, R. Diagnostic Devices: Microneedle-Based Transdermal Sensor for On-Chip Potentiometric Determination of K<sup>+</sup> (Adv. Healthcare Mater. 6/2014). *Adv. Healthcare Mater.* **2014**, *3* (6), 948–948.
- (229) Diamond, D.; Coyle, S.; Scarmagnani, S.; Hayes, J. Wireless sensor networks and chemo-/biosensing. *Chem. Rev.* **2008**, *108* (2), 652–679.

(230) Ferrag, C.; Kerman, K. Grand challenges in nanomaterial-based electrochemical sensors. *Frontiers in Sensors* **2020**, *1*, No. 583822.

(231) Li, H.; Dauphin-Ducharme, P.; Ortega, G.; Plaxco, K. W. Calibration-free electrochemical biosensors supporting accurate molecular measurements directly in undiluted whole blood. *J. Am. Chem. Soc.* **2017**, *139* (32), 11207–11213.

(232) Lipani, L.; Dupont, B. G.; Doungmene, F.; Marken, F.; Tyrrell, R. M.; Guy, R. H.; Ilie, A. Non-invasive, transdermal, path-selective and specific glucose monitoring via a graphene-based platform. *Nature Nanotechnol.* **2018**, *13* (6), 504–511.

(233) Tseng, R. C.; Chen, C. C.; Hsu, S. M.; Chuang, H. S. Contact-lens biosensors. *Sensors* **2018**, *18* (8), 2651.

(234) de Castro, L. F.; de Freitas, S. V.; Duarte, L. C.; de Souza, J. A. C.; Paixão, T. R.; Coltro, W. K. Salivary diagnostics on paper microfluidic devices and their use as wearable sensors for glucose monitoring. *Anal. Bioanal. Chem.* **2019**, *411*, 4919–4928.

(235) Idili, A.; Arroyo-Currás, N.; Ploense, K. L.; Csordas, A. T.; Kuwahara, M.; Kippin, T. E.; Plaxco, K. W. Seconds-resolved pharmacokinetic measurements of the chemotherapeutic irinotecan in situ in the living body. *Chemical science* **2019**, *10* (35), 8164–8170.

(236) Karpova, E. V.; Shcherbacheva, E. V.; Galushin, A. A.; Vokhmyanina, D. V.; Karyakina, E. E.; Karyakin, A. A. Noninvasive diabetes monitoring through continuous analysis of sweat using flow-through glucose biosensor. *Analytical chemistry* **2019**, *91* (6), 3778–3783.

(237) Sempionatto, J. R.; Brazaca, L. C.; García-Carmona, L.; Bolat, G.; Campbell, A. S.; Martin, A.; Wang, J.; et al. Eyeglasses-based tear biosensing system: Non-invasive detection of alcohol, vitamins and glucose. *Biosens. Bioelectron.* **2019**, *137*, 161–170.

(238) Azeredo, N. F.; Gonçalves, J. M.; Rossini, P. O.; Araki, K.; Wang, J.; Angnes, L. Uric acid electrochemical sensing in biofluids based on Ni/Zn hydroxide nanocatalyst. *Microchimica Acta* **2020**, *187*, 1–11.

(239) Baghelani, M.; Abbasi, Z.; Daneshmand, M.; Light, P. E. Non-invasive continuous-time glucose monitoring system using a chipless printable sensor based on split ring microwave resonators. *Sci. Rep.* **2020**, *10* (1), 12980.

(240) Miripour, Z. S.; Sarrami-Forooshani, R.; Sanati, H.; Makarem, J.; Taheri, M. S.; Shojaeian, F.; Abdolahad, M.; et al. Real-time diagnosis of reactive oxygen species (ROS) in fresh sputum by electrochemical tracing; correlation between COVID-19 and viral-induced ROS in lung/respiratory epithelium during this pandemic. *Biosens. Bioelectron.* **2020**, *165*, No. 112435.

(241) Torrente-Rodríguez, R. M.; Lukas, H.; Tu, J.; Min, J.; Yang, Y.; Xu, C.; Gao, W.; et al. SARS-CoV-2 RapidPlex: a graphene-based multiplexed telemedicine platform for rapid and low-cost COVID-19 diagnosis and monitoring. *Matter* **2020**, *3* (6), 1981–1998.

(242) Okpara, E. C.; Ajiboye, T. O.; Onwudiwe, D. C.; Wojuola, O. B. Optical and Electrochemical Techniques for Point-of-Care Water Quality Monitoring: A review. *Results in Chemistry* **2023**, *5*, No. 100710.

(243) Chen, X.; Mo, D.; Gong, M. A flexible method for nanofiber-based 3D microfluidic device fabrication for water quality monitoring. *Micromachines* **2020**, *11* (3), 276.