

Analysis of thermal characteristics of electrical wiring for load groups in cattle barns

Doo Hyun KIM¹, Sang-Ok YOO¹, Sung Chul KIM^{1*} and Dong Kyu HWANG¹

¹Department of Safety Engineering, Chungbuk National University, Republic of Korea

Received November 7, 2014 and accepted June 2, 2015

Published online in J-STAGE June 26, 2015

Abstract: The purpose of the current study is to analyze the thermal characteristics of electrical wirings depending on the number of operating load by connecting four types of electrical wirings that are selected by surveying the conditions for the electric fans, automatic waterers and halogen warm lamps that were installed in cattle barns in different years. The conditions of 64 cattle barns were surveyed and an experimental test was conducted at a cattle barn. The condition-survey covered inappropriate design, construction and misuse of electrical facility, including electrical wiring mostly used, and the mode of load current was evaluated. The survey showed that the mode of load current increased as the installation year of the fans, waterers and halogen lamps became older. Accordingly, the cattle barn manager needed to increase the capacity of the circuit breaker, which promoted the degradation of insulation of the electrical wires' sheath and increased possibility for electrical fires in the long-run. The test showed that the saturation temperature of the wire insulated sheath increased depending on the installation year of the load groups, in case of VCTFK and VFF electric wires, therefore, requiring their careful usage in the cattle barns.

Key words: Electrical fire, Cattle barn, Electric wiring, Thermal characteristics, Mode of load current

Introduction

According to 2013 statistical fire yearbook of NFDS in Korea, the percentage of electrical fire out of total fire breakout in livestock barn was 47% (431 incidents)¹⁾. The main reasons for this high percentage are inappropriate design and electrical wiring, misuse and long use of the electrical facility, and dust as well as gas generated from feces and urine²⁻⁴⁾. The first reason of inappropriate design and wiring occurs as the electrical wiring is done in accordance with general electrical equipment technology standard instead of the electric work standard for the cattle barn that considers the actual barn environment. Among

the electrical equipment for cattle barn, the electric fan, automatic waterer and halogen warm lamp are generally installed in the year of building the cattle barn⁵⁾. The electric fan and automatic waterer are typically installed for more than ten years and the halogen lamp for more than three years. This large number of installation year causes an increase in the load current, which in turn influences the rated allowable current of electric wiring and other facilities. The second reason of misuse occurs mostly with respect to the electrical wiring. Electric wiring installed previously for some other purpose say, is used in many cases without considering its capacity, and majority of the wirings are used for the lamp. The lamp load or the electrical wiring for power outlet is left undone on steel frames after they have been used previously, and the left wires are used for the increased load and moveable load⁶⁾.

The cattle barns use different electrical load depending upon the season, and mainly the summer and winter sea-

*To whom correspondence should be addressed.

E-mail: ksc@chungbuk.ac.kr

©2015 National Institute of Occupational Safety and Health

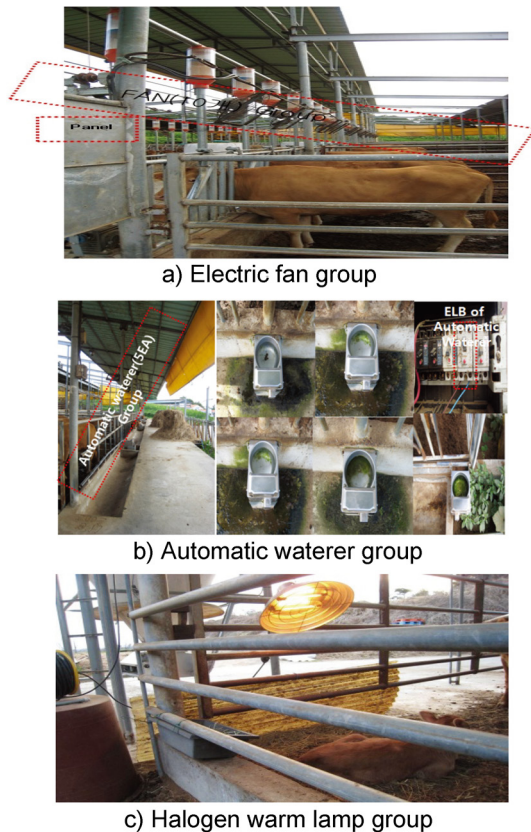

Fig. 1. Electric load groups in cattle barn.

son uses are risky. The electric fan is used in the summer, whereas in the winter, the halogen warm lamps are used to keep the cattle warm along with the use of automatic waterer. The halogen lamp is not a stationary load but installed temporarily. The automatic waterer provides water to the cattle barn and has to be approved to obtain a permanent power supply. However, due to failure of earth leakage breaker sometimes, the water freezes and the pipes of the automatic waterer bursts. To avoid the damage in the pipe, the farm owner replaces the installed earth leakage breaker with a molded case circuit breaker without leakage breaking function⁷⁾.

The current study attempted to find the mode of load current for the electric fan, automatic waterer and halogen warm lamp depending on their installation year, through a survey of the conditions of 64 cattle barns. Four electrical wirings that are mostly used for wiring of the cattle barns were selected. A test was performed to analyze the danger of the mode of load current and the selected electrical wirings. The test venue was a Beonyoung cattle barn and the load groups were the electric fan, automatic waterer and halogen warm lamp. The thermal characteristics of the

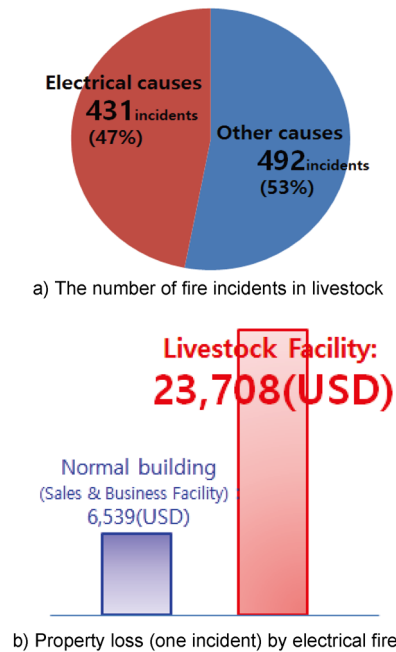

Fig. 2. Electrical fire and property loss in livestock fires, 2013.

electrical wiring were analyzed and the results were suggested. Such thermal characteristics primarily depended on the total number of— electric fans (operating more than 10 yr or less than a year), automatic waterers (operating more than 10 yr or less than a year) and halogen lamps (operating more than 3 yr or less than a year).

Mode of Load Current for Load Groups and Condition of Electric Wirings by Survey

Figure 1 describes the major loads in cattle barn with a) electric fan group, b) automatic waterer group and c) halogen warm lamp group.

Figure 2 a) presents the percentage of different causes of fire in livestock barn. The total number fire incidents in livestock barns was 932 out of which the number of electrical fire incidents was 431. Figure 2 b) shows property loss due to electrical fire of normal building facility (sales & business facility) and livestock facility. The property loss of normal building facility per incident was 6,539 USD and livestock facility per incident was 23,708 USD.

The group of electric fan, automatic waterer and halogen warm lamp in cattle barns have varying mode of load current depending on their installation years. On-site surveys on 64 cattle barns were conducted to analyze the mode of load current for the cattle barn load group and the problems resulting from inappropriate design, construc-

Table 1. Inappropriate design, construction and misuse of electric facility in cattle barns

Classification	Result		Total
	appropriate	inappropriate	
Number of cattle barn	24	40	64
Share (%)	37.5	62.5	100

tion and misuse. Out of these 64 barns, only 24 (37.5%) were found to be appropriate, while 40 (62.5%) were not with respect to inappropriate design, construction and misuse. The inappropriate facilities were primarily due to excessive capacity of the circuit breaker on poor indoor wiring. Table 1 shows the results for inappropriate design, construction and misuse of facilities. Table 2 presents the mode of load current by load groups of the electric fan, automatic waterer and halogen warm lamp that are generally used in cattle barns. In the case of the mode of load current for the load group, the electric fan had the rated capacity of 220 W and ten electric fans were connected to one circuit. The mode of load current was 17 ± 0.5 A when it was more than ten years and 12.1 ± 0.3 A for less than a year. For the fans aged more than 10 yr, ammonia gas or surrounding environment caused aging and deterioration of the insulation inside the fans thus interfering with the fans' normal operation. The automatic waterer's rated capacity was 660 W and five automatic waterers were connected to one circuit. Its mode of load current 17.5 ± 0.5 A when it was more than ten years and 15 ± 0.3 A for less than a year. The halogen warm lamp was 700 W and five halogen warm lamps were connected to one circuit. The mode of load current was 19.5 ± 0.4 A for more than three years and about 16.5 ± 0.2 A for less than a year. The survey also revealed that the electrical wirings were arbitrary and hanged from the ceiling, whereas the wirings for some other purposes were fixed to the steel frame. Moreover, inappropriate electrical wirings were also used arbitrarily for lighting or halogen warm lamp. VCTFK (Vinyl insulated Vinyl Cabtyre Cord) electrical wiring was used in six cattle barns according to the survey. The sheath was found to be hardened and heated over 75°C . VFF (Vinyl Insulated Non-Sheathed Cords) wiring was used in 5 barns while HIV (Heat resistance In-door PVC insulated wire) wiring in 38 and CV (Cross linked polyethylene insulated cable) in 15. Recently, CV 2.0 mm^2 and HIV 1.6 mm^2 are not produced any more but CV 2.5 mm^2 and HIV 1.5 mm^2 are. Furthermore, the danger of using the VCTFK and VFF wirings was not realized and they were used for moveable loads instead of the stationary ones. Table 3 shows the

Table 2. Mode of load current of each load group in cattle barn

Type of load group	Rated capacity (W)	Installation year	Mode of load current (A)
Electrical fan	220	More than 10 yr	17 ± 0.5
		Less than 1 yr	12.1 ± 0.3
Automatic waterer	660	More than 10 yr	17.5 ± 0.5
		Less than 1 yr	15 ± 0.3
Halogen lamp	700	More than 3 yr	19.5 ± 0.4
		Less than 1 yr	16.5 ± 0.2

Table 3. Allowable current and temperature of four types of electrical wirings

Electric wire	Allowable current [A]	Allowable temp. [$^\circ\text{C}$]
VCTFK (0.75 mm^2)	7	60
VFF (0.75 mm^2)	7	70
HIV (1.6 mm^2)	23	75
CV (2.0 mm^2)	31	90

allowable current and temperature of four types of electric wirings⁸.

Experimental test equipment

Electric fan of 220 W (small, ten units) by M Electricity company, automatic waterer of 660W (five units) by H Machine company and halogen warm lamp of 700W (five units) by Y Company were installed on-site that are more than ten years old and less than a year old. VCTFK (0.75 mm^2), VFF (0.75 mm^2), HIV (1.6 mm^2) and CV (2.0 mm^2) were also used in the experimental test. A622 AC/DC current probe of Tectronix Company was chosen to measure the current and NI-9215 of the same company was used to collect the signal coming from the current probe. FLIR 4 series that can analyze the temperature ranging from -40 to $1,000^\circ\text{C}$ and thermal imaging camera that can record and save video in real time were used. Fig. 3 describes the experimental circuit diagram of a) electric fan group, b) automatic waterer group and c) halogen warm lamp group.

Results and Analysis

Electric fan group

The saturation temperature on each electrical wire's insulation higher than the allowable temperature was measured for the number of operating electric fans more than ten years and less than a year old. The electric fans that were more than ten years old and connected by VCTFK

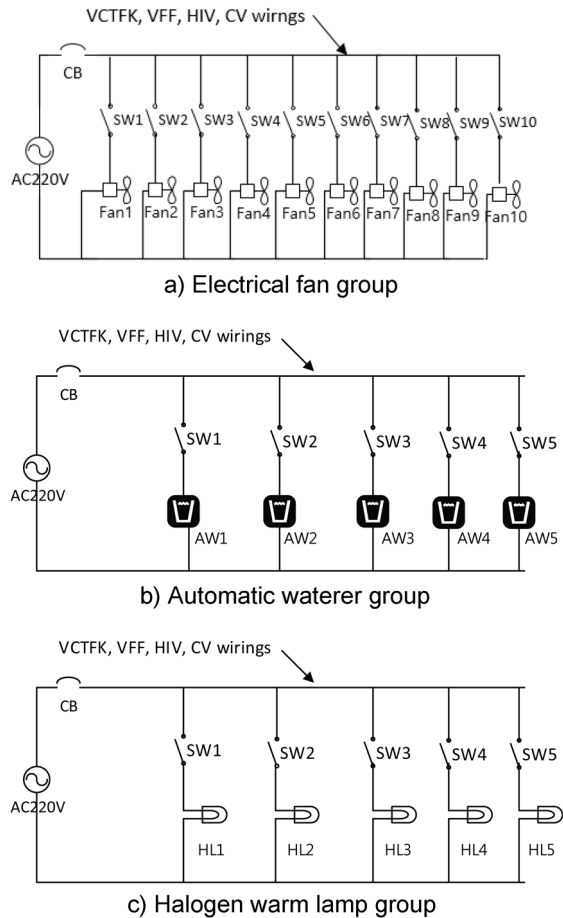
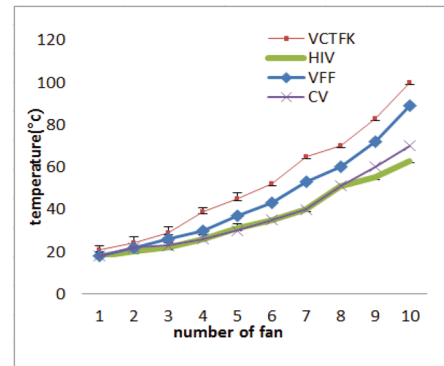

Fig. 3. Experimental test set ups for load groups and wirings.

wire (seven units) and VFF wire (eight units) exceeded the allowable temperature. Although the cross-sectional diameter of the insulators was the same, the temperature was found different because of different insulator thickness. On the other hand, the fans by HIV and CV wires did not exceed the allowable temperature. The fans less than a year connected by VCTFK wire (ten units) exceeded the permissible temperature, whereas the fans connected by the other wires did not. Figure 4 presents the thermal characteristics of VCTFK, VFF, HIV and CV wirings depending on the number of operating electric fans that were more than ten years and less than a year old.

Automatic waterer group

Five automatic waterers with the capacity of 660 W formed a group, which caused the load current to rise in winter, spring and fall due to long uses, which in turn increased the risk and danger. Furthermore, the automatic waterers were usually installed in the same year of building the cattle barn. After their installation, the waterers



a) More than ten years

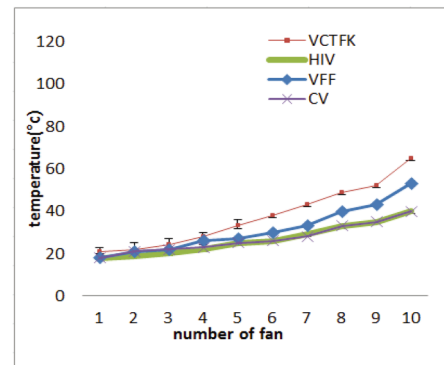

b) Less than one year

Fig. 4. Thermal characteristics of VCTFK, VFF, HIV and CV wirings by number of operating electric fans.

had never been checked nor had their wire been replaced, which caused problems as time went by. The saturation temperature on each electrical wire's insulation was higher than the allowable temperature and was measured for the number of operating automatic waterers more than ten years and less than a year old. The waterers that were more than ten years old and connected by VCTFK wire (three units) and VFF wire (four units) exceeded the allowable temperature. On the other hand, HIV and CV wires did not exceed the allowable temperature. For those which are less than a year old, the VCTFK and VFF (five units) exceeded the allowable temperature but the other wires did not. Figure 5 illustrates the thermal characteristics of VCTFK, VFF, HIV and CV wirings depending on the number of operating automatic waterers more than ten years and less than a year old.

Halogen warm lamp group

A halogen warm lamp protects the calves from cold and freezing to death. However, it also causes local fire easily as it can ignite nearby flammable materials, such as warm mats and synthetic resin boards. In addition, when

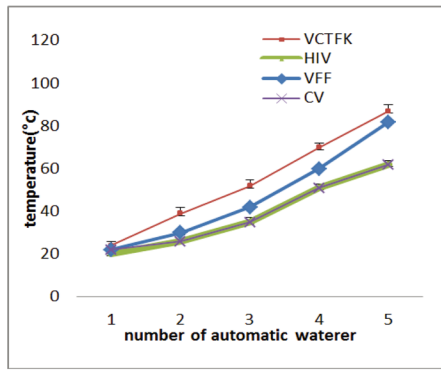

a) More than ten years

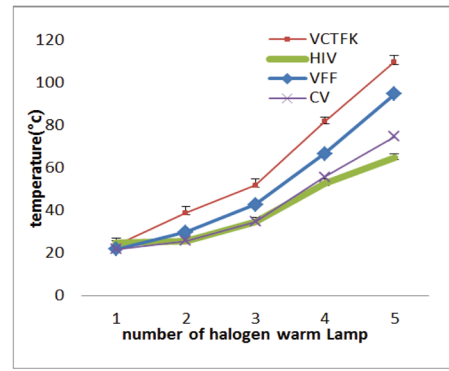

a) More than three years

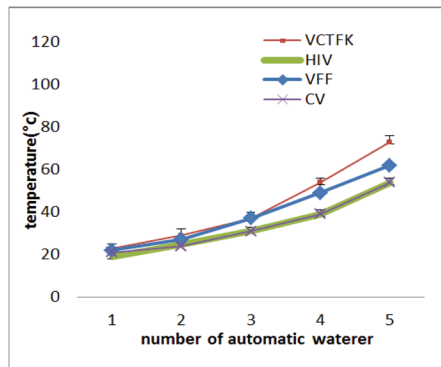

b) Less than one year

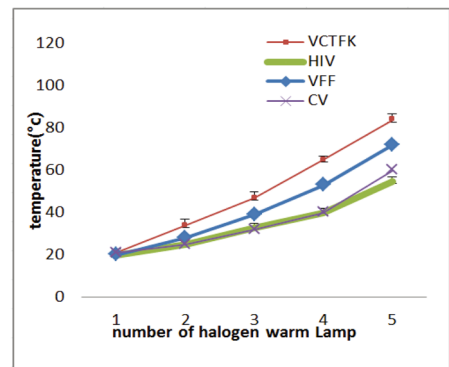

b) Less than one year

Fig. 5. Thermal characteristics of VCTFK, VFF, HIV and CV wirings by number of operating automatic waterers.

Fig. 6. Thermal characteristics of VCTFK, VFF, HIV and CV wirings by number of operating halogen warm lamps.

the number of operating units, with capacity of 700W, increases, the load current also increases, raising the chance of potential danger.

The saturation temperature on each electric wire's insulation higher than the allowable temperature was measured for the number of operating halogen warm lamps that were more than three years and less than a year old. The halogen lamps that were more than three years old and connected by VCTFK wire (three units) and VFF wire (four units) exceeded the allowable temperature. On the other hand, the lamps connected by HIV and CV wires did not exceed the allowable temperature. The lamps less than a year old and connected by VCTFK (five units) and VFF (five units) wires exceeded the permissible temperature. Figure 6 presents the thermal characteristics of VCTFK, VFF, HIV and CV wirings depending on the number of operating halogen warm lamps more than three years and less than a year old.

Analysis of temperature of electric wirings for number of operating loads

Table 4 presents the saturation temperature of the VCT-

FK, VFF, HIV and CV wirings connected to the electric fan, automatic waterer and halogen warm lamp. Among the electrical wirings, when the VCTFK electrical wire was connected to the electric fan, the temperature was 99°C for more than ten years and 65°C for less than a year, showing a difference of 34°C. For the automatic waterer, it was 89°C for more than ten years and 73°C for less than a year with 16°C difference. For the case of halogen warm lamps, it was 110°C for more than three years and 84°C for less than a year with 26°C difference. A difference of up to 34°C was recorded depending on the installation year.

Conclusions

The current study surveyed the condition of 64 cattle barns and analyzed the thermal characteristics of four electrical wirings depending on the number of operating load group of electric fan, halogen warm lamp and automatic waterer in a cattle barn in Cheongwon area. The following results were obtained.

- 1) In cattle barns, the principal cause of electrical fire

Table 4. Measured saturation temperature of four types of electric wirings connected to load groups.

Load group	Wirings (mm ²)	Installation year	Operating number of loads	Temperature (°C)
Electric fan	VCTFK	10 yr	10	99
	(1.75)	1 yr	10	65
	VFF	10 yr	10	89
	(1.75)	1 yr	10	53
	HIV	10 yr	10	63
	(1.6)	1 yr	10	40
	CV	10 yr	10	70
	(2.0)	1 yr	10	39
Automatic waterer	VCTFK	10 yr	5	89
	(1.75)	1 yr	5	73
	VFF	10 yr	5	82
	(1.75)	1 yr	5	71
	HIV	10 yr	5	61
	(1.6)	1 yr	5	51
	CV	10 yr	5	60
	(2.0)	1 yr	5	52
Halogen lamp	VCTFK	3 yr	5	110
	(1.75)	1 yr	5	84
	VFF	3 yr	5	95
	(1.75)	1 yr	5	72
	HIV	3 yr	5	65
	(1.6)	1 yr	5	55
	CV	3 yr	5	72
	(2.0)	1 yr	5	60

is electrical wiring, which is highly related to excessive capacity of the circuit breaker.

2) The temperature increased largely depending on the installation year of load groups in case of VCTFK and VFF electrical wires. Therefore, it is suggested that VCTFK and VFF electrical wires must be carefully applied to the load group of the electric fan, automatic waterer and

halogen warm lamp in cattle barns, while HIV and CV wires could be applied considering the size of wires before using.

3) As the installation year of electric fan, automatic waterer and halogen warm lamp became older, the mode of load current increased. So it is required to take more care in the installation year of the facilities to prevent electrical fires in cattle barns.

4) Poor environment of a cattle barn can accelerate the deterioration of electrical equipment and electrical wires, and thereby increase the mode of load current. Therefore, management and design of barns that accounts for the deterioration of the insulation of electrical equipment and wires is necessary based on the data from the test and survey.

References

- 1) National Fire Data System <http://www.nfds.go.kr>. Accessed June 10, 2014.
- 2) Kim SC, Kim DH (2012) Analysis of characteristic for electric leakage component at stable size. *Korea Soc Saf*, 54–58 (in Korean).
- 3) Yonhap news Cause of cattle barns fire in winter (2009) <http://www.yonhapnews.co.kr>. Accessed June 10, 2014.
- 4) Kim SJ (2011) Conformity Assessment of Wires and Panel Board by Electrical Loads in Livestock Barn, 1–3, Chungbuk National University, Master's thesis.
- 5) Korea Electrical Safety Corporation (2005) Barn fire hazard electrical equipment survey report, 1–3.
- 6) KESCO (2002) Winter livestock barn electricity usage with increased electrical fire hazard.
- 7) Kim CH, Kim SC, Yoo SO, Kim SR, Kim YB (2011) A study on leakage current detecting system for automatic waterer using livestock barn. *J Korea Soc Saf* **26**, 34–40 (in Korean).
- 8) KESCO (2006) Hand Book for Electrical Safety Management, 103–109.