

Research

Open Access

Magnetic stimulation for non-homogeneous biological structures

Vessela T Krasteva, Sava P Papazov and Ivan K Daskalov*

Address: Center of Biomedical Engineering Acad. G. Bonchev str. block 105 Sofia 1113, Bulgaria

E-mail: Vessela T Krasteva - vessika@clbme.bas.bg; Sava P Papazov - papasow@vmei.acad.bg; Ivan K Daskalov* - ikdas@argo.bas.bg

*Corresponding author

Published: 17 September 2002

Received: 13 August 2002

BioMedical Engineering OnLine 2002, 1:3

Accepted: 17 September 2002

This article is available from: <http://www.biomedical-engineering-online.com/content/1/1/3>

© 2002 Krasteva et al; licensee BioMed Central Ltd. This article is published in Open Access: verbatim copying and redistribution of this article are permitted in all media for any purpose, provided this notice is preserved along with the article's original URL.

Abstract

Background: Magnetic stimulation has gained relatively wide application in studying nervous system structures. This technology has the advantage of reduced excitation of sensory nerve endings, and hence results in quasi-painless action. It has become clinically accepted modality for brain stimulation. However, theoretical and practical solutions for assessment of induced current distribution need more detailed and accurate consideration.

Some possible analyses are proposed for distribution of the current induced from excitation current contours of different shape and disposition. Relatively non-difficult solutions are shown, applicable for two- and three-dimensional analysis.

Methods: The boundary conditions for field analysis by the internal Dirichlet problem are introduced, based on the vector potential field excited by external current coils. The feedback from the induced eddy currents is neglected. Finite element modeling is applied for obtaining the electromagnetic fields distribution in a non-homogeneous domain.

Results: The distributions were obtained in a non-homogeneous structure comprised of homogeneous layers. A tendency was found of the induced currents to follow paths in lower resistivity layers, deviating from the expected theoretical course for a homogeneous domain. Current density concentrations occur at the boundary between layers, suggesting the possibility for focusing on, or predicting of, a zone of stimulation.

Conclusion: The theoretical basis and simplified approach for generation of 3D FEM networks for magnetic stimulation analysis are presented, applicable in non-homogeneous and non-linear media. The inconveniences of introducing external excitation currents are avoided. Thus, the possibilities are improved for analysis of distributions induced by time-varying currents from contours of various geometry and position with respect to the medium.

Background

The theory of electromagnetic fields can be considered as quite well developed. Nevertheless, some problems could be pointed-out in connection with its application to stimulation of biological structures:

- distribution and spread of the time-varying magnetic field in non-linear and inhomogeneous domains of complex geometry;
- the interaction of electromagnetic pulses with biophysical and physiological processes;

- stationary or non-stationary processes of random and stray factors type, e.g. changes in the stimulated structure;

- technical and technological aspects, e.g. coils shape and disposition with respect to the stimulated structures.

There may be other practical and theoretical problems connected with magnetic stimulation. However, in different medical applications, various approximate or heuristic solutions were found [1].

Published studies on electromagnetic field stimulation most often are based on distribution and propagation in homogeneous media. This approach could be correct for stationary magnetic field analysis, as biological tissues relative magnetic permeability is μ_r approximately equal to 1. In cases of time-varying magnetic field, feedback from the induced currents may be present. However, when propagation takes place in a weakly conductive medium, the intensity of the feedback-induced magnetic field would be several orders of magnitude lower than the external field. The induced field can then be ignored, and the medium considered to be homogeneous with respect to the external magnetic field.

On the other hand, the condition of continuity of the current lines requires taking into account all regions with different specific conductivities. An exception here is the case where the induced currents propagate tangentially to the layers in a non-homogeneous medium.

In some studies, the presence of non-homogeneities has been taken into account. Transcranial magnetic stimulation, where the scalp, skull, and brain represent a layered non-homogeneous structure, is a typical example [2,3]. A theoretical approach, applying a scalar magnetic potential in addition to the vector potential has been proposed as an alternative to finite-element modeling (FEM), but has considered only a simplified basic example [4]. FEM has been used for assessment of magnetically-induced currents for heart stimulation, with inclusion of the non-homogeneities of a canine thorax [5]. Field magnitudes for efficient myocardial stimulation were computed. Magnetic flux density in the upper arm, taking into account the skin and muscle layers and the bone, have been assessed for different coil designs [6]. A study of stimulation in the spinal region [7] has shown a tendency for current density concentration about the nerve roots. However, acceptable accuracy in evaluation of the induced currents values could only be attained when these currents were assessed on the basis of an appropriately obtained magnetic field distribution. A tendency of induced current concentrations at the interfaces between structures of strongly differing conductivity could be observed [3,7].

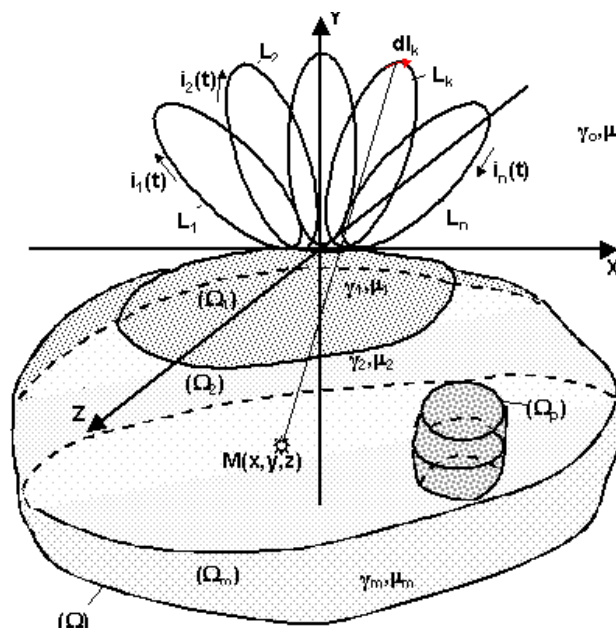

Figure 1 Magnetic stimulation applied on a non-homogeneous volume as a rough simulation of a human body structure. Several coil contours L_i with excitation currents I_i are positioned in the air (γ_0 and μ_0 are the air specific conductivity and magnetic permeability) on the upper surface of the volume. The structure consists of various layers and zones Ω_m of different conductivities γ_m and magnetic permeabilities μ_m .

The present work investigates some possibilities for modeling and theoretical analysis of induced current distribution during magnetic stimulation, with excitation current contours of different shape and disposition. Relatively non-difficult solution approaches are proposed, applicable for two-dimensional and three-dimensional problems of field distribution in non-homogeneous media.

Theoretical background

Initial conditions

Electrical current contours are positioned in the air above a partially homogeneous conductive medium that consists of homogeneous layers (Fig. 1), simulating part of the human body. The mean values of the electromagnetic parameters μ (magnetic permeability) and γ (specific conductivity) of the corresponding layers are assumed to be known. Each layer is taken as linear and isotropic. Effects of random factors are not considered.

The electrical currents in the several contours $i_k(t)$; $k = 1, 2, \dots, n$ are generated by an electromagnetic stimulator and create an alternating magnetic field. The distribution of the magnetic field in the examined region is described by the Maxwell equations in the form:

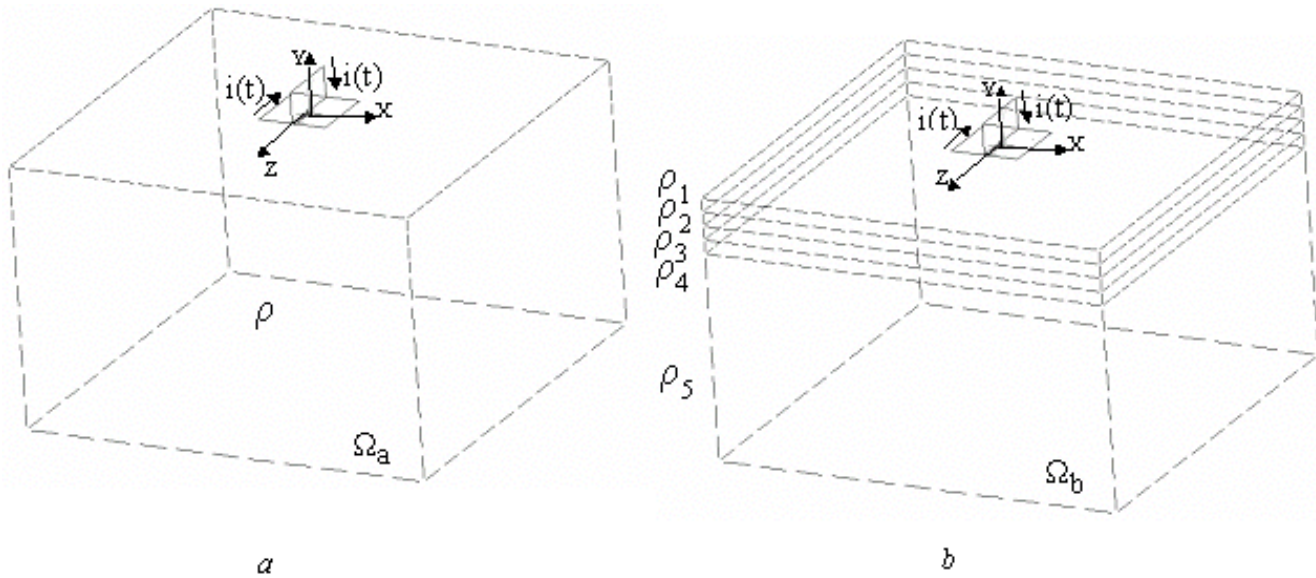

Figure 2
 Models of (a) – homogeneous domain (Ω_a) of specific resistivity ρ and (b) – a layered non-homogeneous domain (Ω_b), consisting of a series of homogeneous layers of specific resistivities ρ_i . Vertical (in the ZOY plane) and horizontal (in the XOZ plane) rectangular excitation coil contours are positioned on the upper surface (XOZ plane).

$$rot\vec{H} = \gamma\vec{E} + \epsilon\frac{\partial\vec{E}}{\partial t} + \vec{J}_{exc} \quad (1)$$

$$\vec{E} = -\frac{\partial\vec{A}}{\partial t} - gradV, \quad (2)$$

where, besides the field vectors \vec{E} and \vec{H} , the electromagnetic potentials \vec{A} and V also take part. The last term \vec{J}_{exc} in Eq. (1) represents the independent external excitation currents $i_k(t)$, generated by a current source.

It is well known that Eqs. (1) and (2) are valid for an arbitrary medium (ϵ is the dielectric permittivity) and time-varying field vectors and their respective electromagnetic potentials.

The component in Eq. (1) related to the displacement current $\epsilon\frac{\partial\vec{E}}{\partial t}$ can be ignored for quasi-stationary fields, as in the present case. Incorporating Eq. (2) in Eq. (1), and expressing \vec{H} by the relation $\vec{H} = \frac{1}{\mu}rot\vec{A}$, the following equation is obtained:

$$rot\vec{rot}\left(\frac{1}{\mu}rot\vec{A}\right) = \gamma\left(-\frac{\partial\vec{A}}{\partial t} - gradV\right) + \vec{J}_{exc} \quad (3)$$

Eq. (3) is valid for an arbitrary medium. Generally, the material constants in case of non-homogeneity should be considered as functions of the spacial co-ordinates and in anisotropic media – as tensor quantities. In cases of non-linear media, the material constants are functions of the field vectors.

For homogeneous linear and isotropic medium, using the Lorentz gauge [9] gives:

$$div\vec{A} + \gamma\mu V = 0, \quad (4)$$

and the non-homogeneous diffusion equation is obtained:

$$\nabla^2\vec{A} - \gamma\mu\frac{\partial\vec{A}}{\partial t} = -\mu\vec{J}_{exc} \quad (5)$$

It is known that in harmonic mode, this equation can be reduced to the Helmholtz equation:

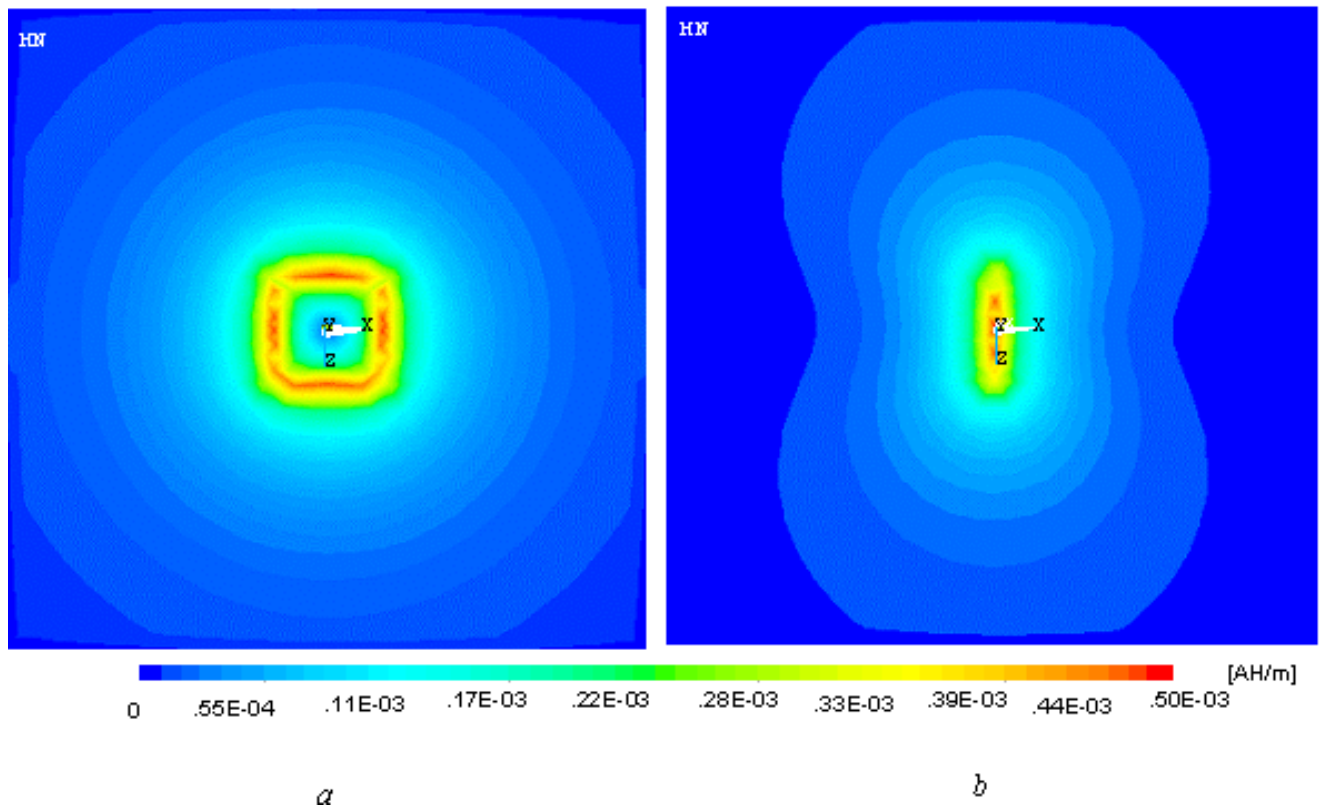

Figure 3
 Magnetic vector-potential distribution, with potentials applied at the XOZ nodes. The excitation current $I = 1000$ A, $f = 10$ kHz flows in horizontally (a) or vertically (b) positioned coils.

$$\nabla^2 \dot{\vec{A}} - j\omega\gamma\mu\dot{\vec{A}} = -\mu\dot{\vec{J}}_{exc} \quad (6)$$

Equations (5) and (6) are also applicable for partially homogeneous media, as depicted in Fig. 1. In the internal part of the non-homogeneous region Ω , where $\vec{J}_{exc} = 0$, Eq. (5) and (6) reduce to the respective homogeneous equations. For the region external to Ω (air space), $\gamma \rightarrow 0$, $\mu = \mu_0$ and negligible $\frac{\partial \vec{A}}{\partial t}$, Eqs. (5) and (6) reduce to the Poisson equation:

$$\nabla^2 \vec{A} = -\mu\vec{J}_{exc}; \nabla^2 \dot{\vec{A}} = -\mu\dot{\vec{J}}_{exc} \quad (7)$$

The solution for stationary mode and a homogeneous medium with respect to μ , is:

$$\vec{A}(x, y, z) = \frac{\mu}{4\pi} \iiint_{(v)} \frac{\vec{J}_{exc}(x, y, z)}{r} dv. \quad (8)$$

For current contours of relatively small cross section and for alternate current, a known formula is obtained:

$$\vec{A}(x, y, z, t) = \frac{\mu i(t)}{4\pi} \oint \frac{d\vec{l}}{r} \quad (9)$$

For the case shown in Fig. 1:

$$\vec{A}(x, y, z, t) = \frac{\mu_0}{4\pi} \sum_{k=1}^n i_k(t) \oint_{L_k} \frac{d\vec{l}_k}{r_k}. \quad (10)$$

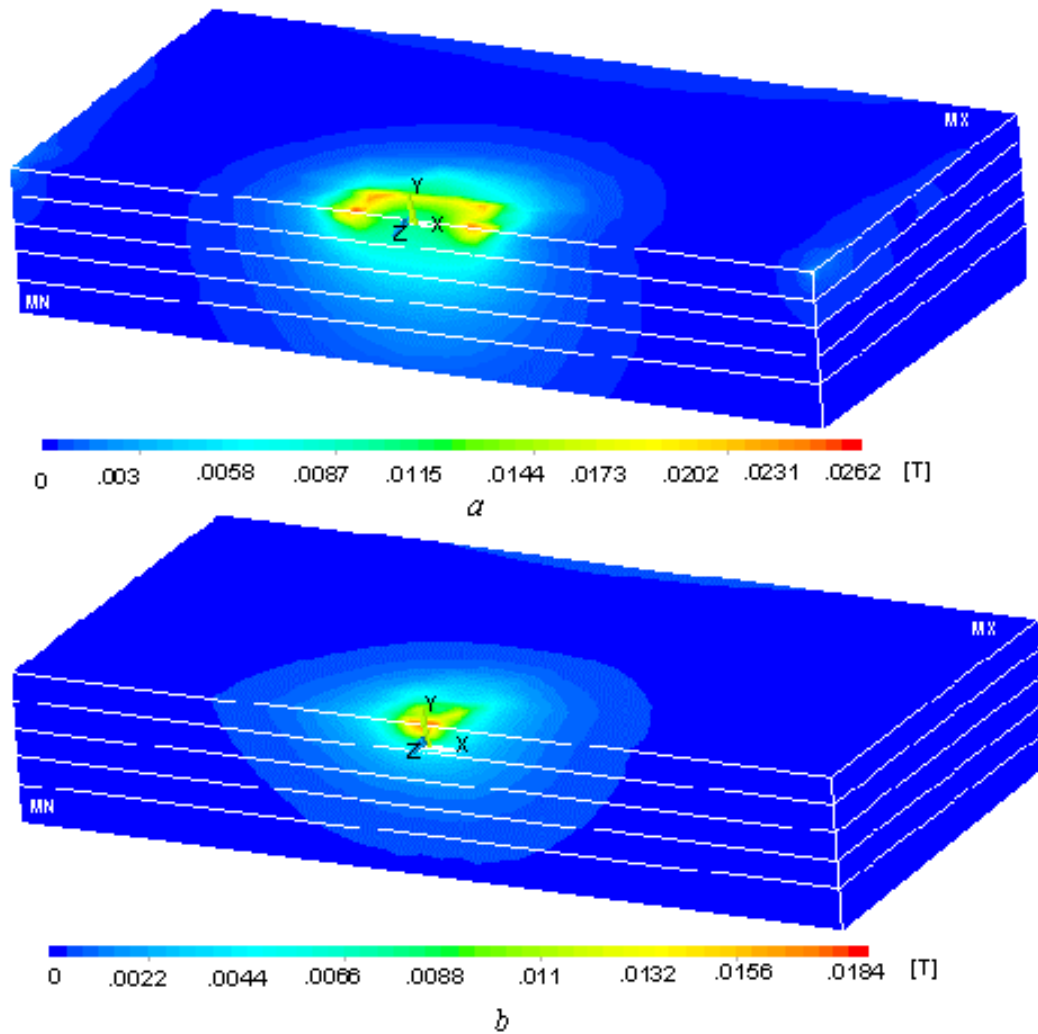

Figure 4
 Distribution of the external magnetic field in the non-homogeneous model domain, excited by the current in horizontally (a) and vertically (b) positioned coils. The viewing angle shows the vertical (XOY) section and the upper horizontal plane (XOZ).

The conditions $\mu_1 = \mu_2 = \dots = \mu_m = \mu_0$ are respected for the different sub-regions ($\Omega_1, \Omega_2, \dots, \Omega_m$) of the non-homogeneous medium Ω (Fig. 1) and for the external space. The non-homogeneous medium Ω , with specific conductivities $\gamma_1 \neq \gamma_2 \neq \dots \neq \gamma_p \neq \dots \neq \gamma_m$, can be of layered structure, or include internal sub-spaces Ω_p . It is evident, that the feedback from the eddy currents induced in the non-homogeneous medium Ω can be neglected, compared to the direct action of the external excitation.

Induced currents in the medium

The induced field and the eddy currents in the Ω -medium are obtained by the procedure described below.

The values of the vector-potential on the external surface of Ω are computed from Eq. (10) in all nodes necessary for the solution of the internal Dirichlet problem.

Using the homogeneous equation for the diffusion, relating to the magnetic vector-potential:

$$\nabla^2 \bar{A}_\mu - \gamma \mu \frac{\partial \bar{A}}{\partial t} = 0, \quad (11)$$

or, for harmonic mode, the Helmholtz equation:

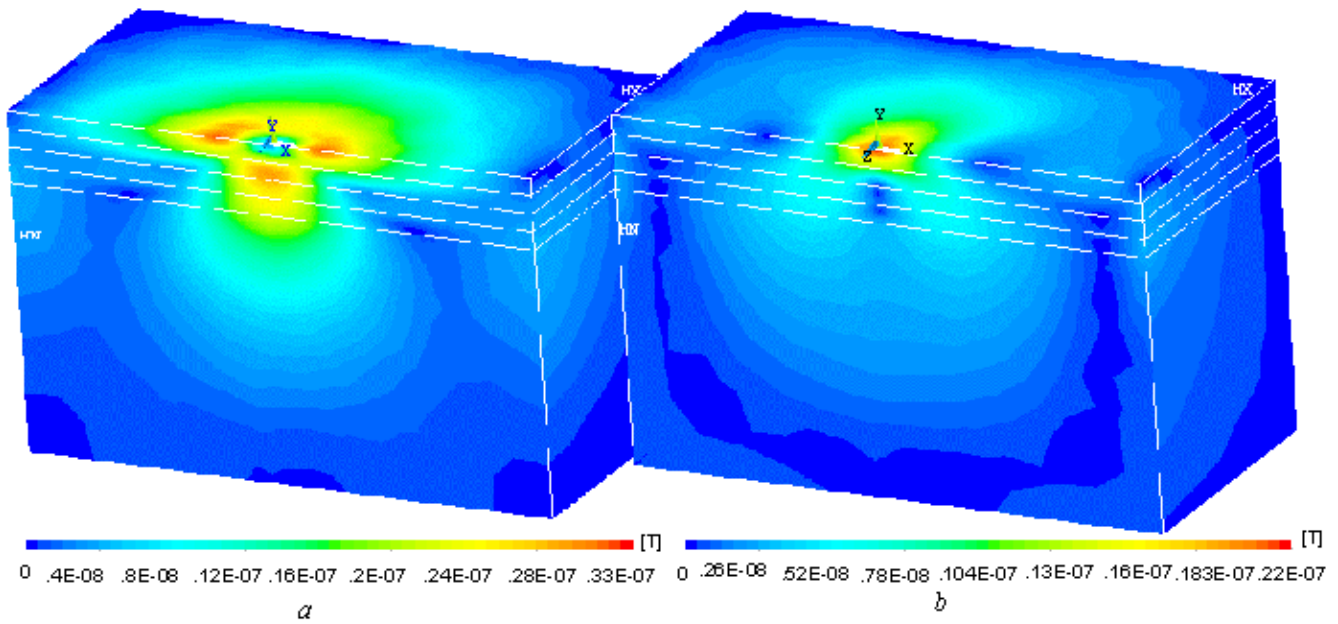

Figure 5
 Distribution of the modulus of the magnetic field of the induced currents, excited by the horizontally (a) and vertically (b) positioned coils. Section and viewing angle – as in Fig. 4.

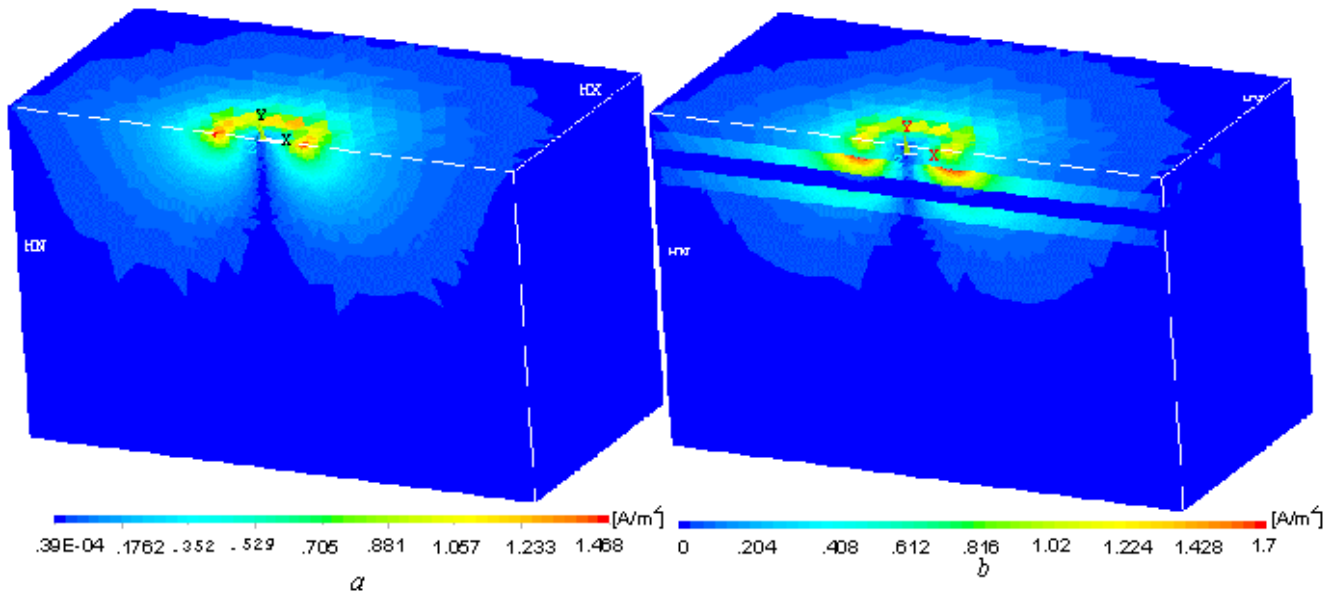

Figure 6
 Distribution of the modulus of the current density vector in the homogeneous (a) and non-homogeneous (b) domains from a horizontally positioned coil. Section and viewing angle – as in Fig. 4,5.

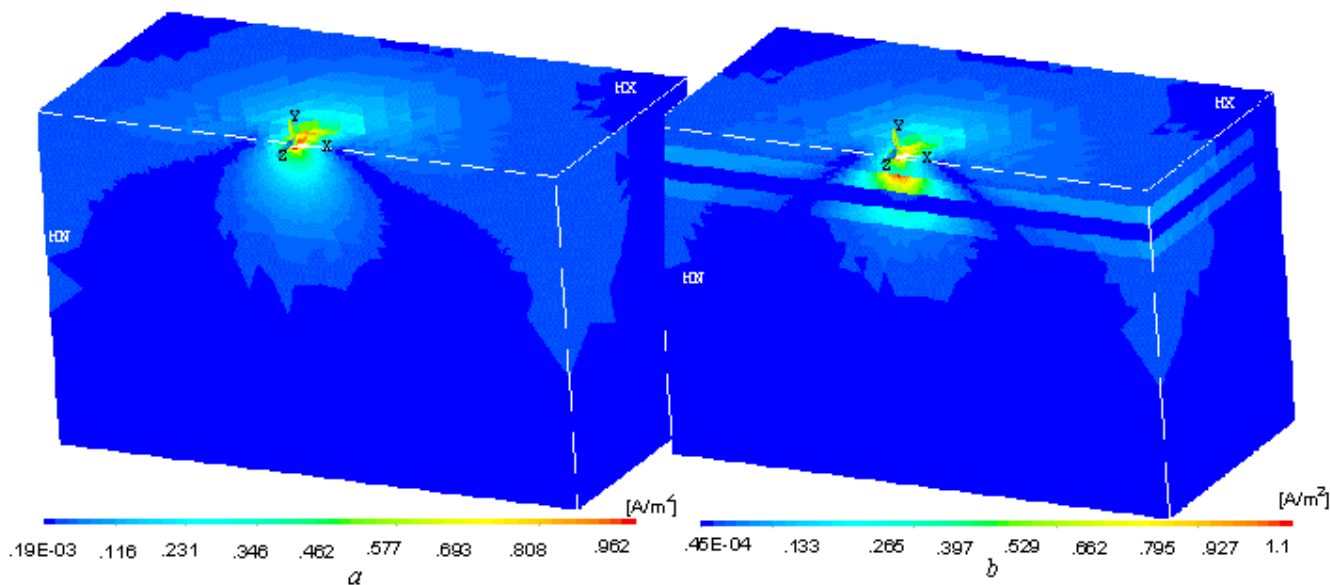

Figure 7
 Distribution of the modulus of the current density vector in the homogeneous (a) and non-homogeneous (b) domains from a vertically positioned coil. Section and viewing angle – as in Fig. 4,5,6.

$$\nabla^2 \vec{A}_\mu - j\omega\mu\vec{A} = 0, \quad (12)$$

the internal Dirichlet problem is solved. The boundary conditions for the vector-potential are defined by Eq. (10) for the boundary surface S_Ω of the space Ω , subjected to electromagnetic stimulation. The feedback from the induced field was ignored, as discussed above. The respective conditions are valid for refraction of the field vector lines at the boundaries of two homogeneous regions [8,9].

The solution of Eq. (10), having in view the boundary conditions, does not present theoretical or computational difficulties. The problem of field distribution in the non-homogeneous space Ω is solved by the finite element method (FEM) or by the boundary element method (BEM). Using appropriate software, the field and the currents induced by the external field in a weakly-conductive medium are obtained, together with the magnetic field of the induced currents.

Methods

In order to verify the applicability of the approach described in Section 2 above, a 3D spacial model consisting of five transverse layers was constructed, as a very approximate simulation of a biological object. The initial model consisted of 19,218 nodes and 104,693 eight-node brick elements. Two versions of the model were considered, al-

lowing assignment of different resistivities to the respective layers, as follows:

a) homogeneous medium Ω_a of specific resistivity $\rho = 20 \Omega m$ (Fig. 2a); the value was chosen as a rough average of very high and very low conductivities (soft tissue and blood; and bone and lung air, respectively).

b) non-homogeneous medium Ω_b containing isotrope layers of specific resistivities (Fig. 2b), chosen to correspond to body regions [10,11], as follows: $\rho_1 = 20 \Omega m$ – skin, $\rho_2, \rho_4 = 7 \Omega m$ – skeletal muscle, $\rho_3 = 160 \Omega m$ – bone, $\rho_5 = 20 \Omega m$ – 'buffer' zone needed to allow setting of adequate boundary conditions; for this test example, the layers were made of equal thickness, except for the buffer zone.

The external magnetic field was excited by a square-shaped coil. Two examples were considered initially (Fig. 2), with coils placed symmetrically on the upper surface of the 3D model: i) coil in horizontal position (XOZ plane), and ii) coil in vertical position (YOZ plane). The excitation current was arbitrarily chosen to be $I = 1000 A_{rms}$ with a frequency $f = 10$ kHz. The calculated values of the magnetic-vector-potentials were applied on the upper surface nodes of the model (1011 nodes), as magnetic boundary loads. Zero boundary conditions were adopted for the other surfaces. Harmonic magnetic analysis was performed to obtain the eddy currents distribution in the medium.

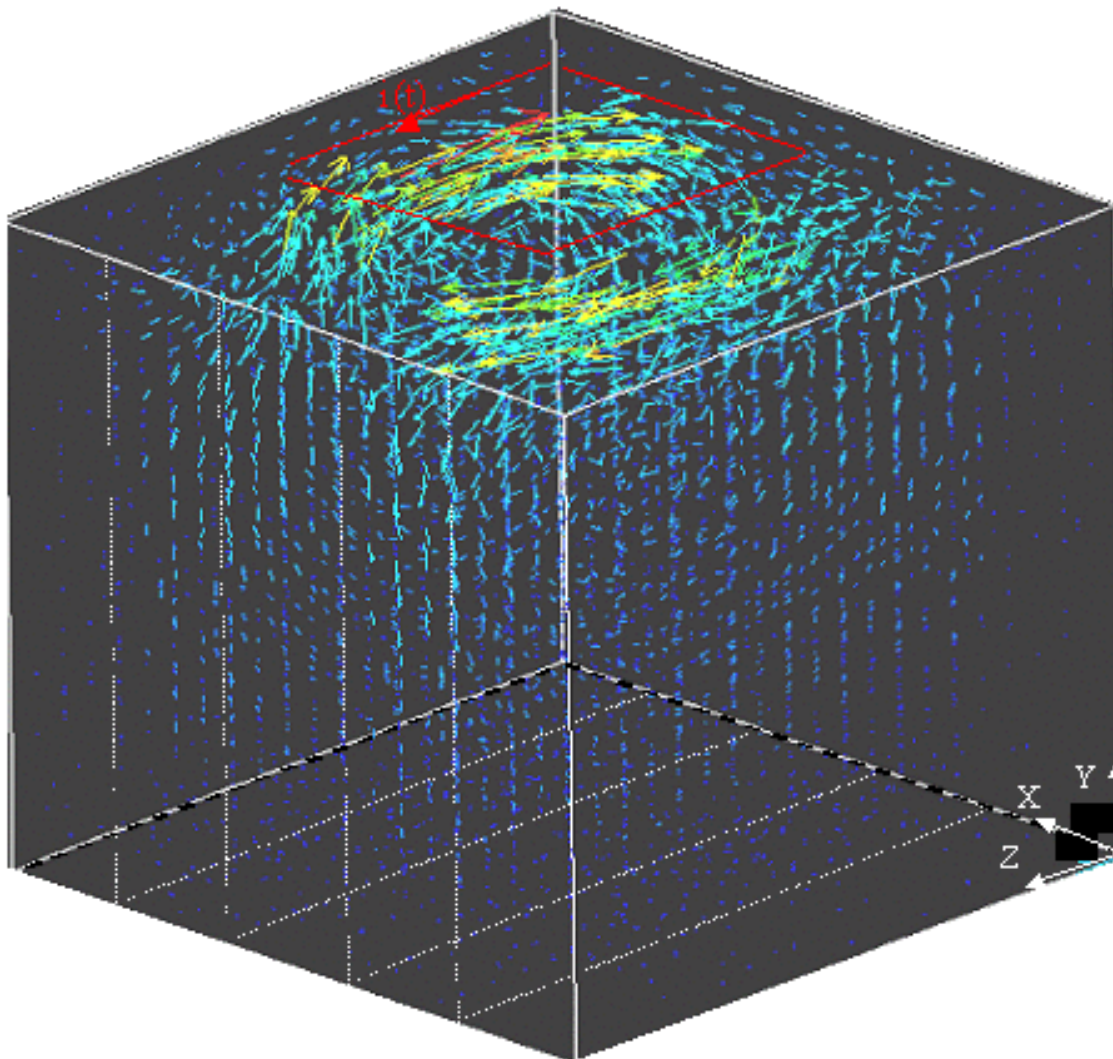

Figure 8

Current density vector distribution obtained from a horizontally positioned (XOZ plane) coil in a vertically-sliced non-homogeneous volume.

Results

The magnetic vector-potential distributions, induced by the horizontal and vertical current contours on the upper XOZ surface of the 3D model, are shown respectively in Fig. 3a,3b. The excited magnetic fields, viewed in a central XOY section and on the XOZ plane, are presented in Fig. 4a,4b for the corresponding current coil dispositions. Due to the homogeneous character of the layered structure with respect to the magnetic permeability μ , and the neglected induced currents feedback, the external magnetic field distribution is not influenced by the non-homogeneities of the domain with respect to the specific conductivity γ .

The magnetic fields excited by the induced currents in a non-homogeneous medium, from a horizontal and a vertical coil dispositions are shown in Figs. 5a,5b. The distribution of the eddy currents induced by a horizontal current contour in the homogeneous and non-homogeneous domains are shown in Fig. 6a,6b, respectively. The same distributions for the vertical coil are presented in Fig. 7a,7b.

It was found that the current lines tend to form loops in the low resistivity layers, in addition to running in opposition to the excitation current, as would be in an homogeneous medium. In order to better observe the induced current lines across layers of different resistivities, the non-homogeneity is modeled by vertical layers and the

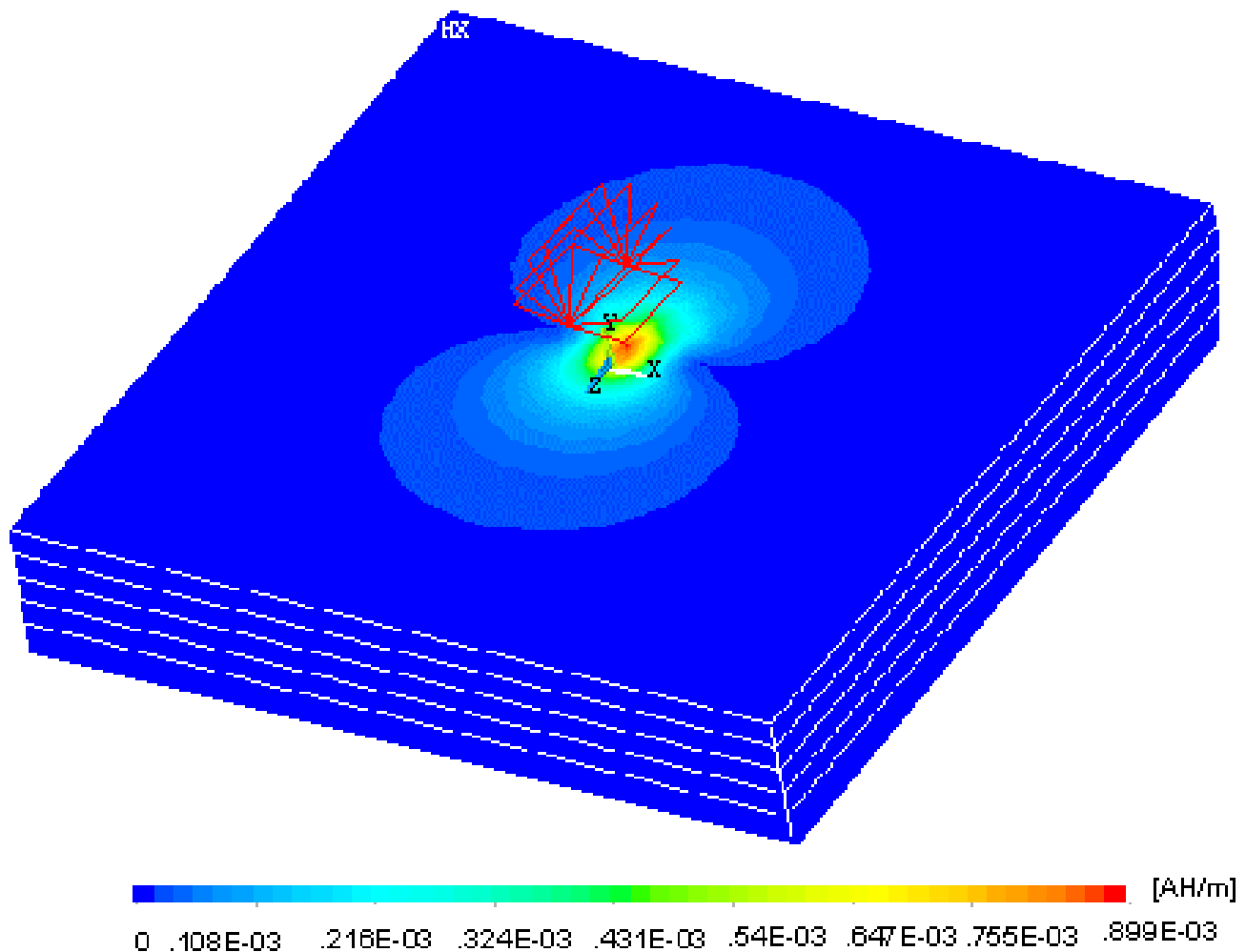

Figure 9
Magnetic vector-potential distribution on the domain surface (XOZ), excited by rectangular coils in a fan-like assembly (slinky coils).

coil position is on the upper surface of the medium, in the XOZ plane (Fig. 8). The effect of more complicated current contours can also be studied. The distribution of the induced vector-potential by the fan-like assembly (slinky coils, [12]), viewed from the upper XOZ surface, is shown in Fig. 9. The corresponding eddy currents distributions in the homogeneous and non-homogeneous media are shown in Fig. 10a,10b.

Discussion

The approach proposed in Section 2.2 considerably reduces the problems connected with generation of 3D FEM networks. However, this approach preserves the power for analysis in non-homogeneous and, in non-linear media. The inconveniences of introducing external excitation currents are avoided. Thus, the possibilities are improved for analysis of field distributions induced by different time-

varying currents, with contours of various geometry and position with respect to the stimulated object.

A systematic error is introduced due to the ignored feedback from the eddy currents. However, this error is negligible, considering the low intensity of the eddy currents in the weakly conductive medium. These currents have their own magnetic field, which is several orders of magnitude lower than the external magnetic field from the stimulation coils, as can be seen in comparing the distributions in Fig. 5 and Fig. 4.

There exist theoretical possibilities by using an iteration procedure [e.g. [13]], for taking into account the feedback. Such a technique has been used in the development and practical application of numerical methods for field anal-

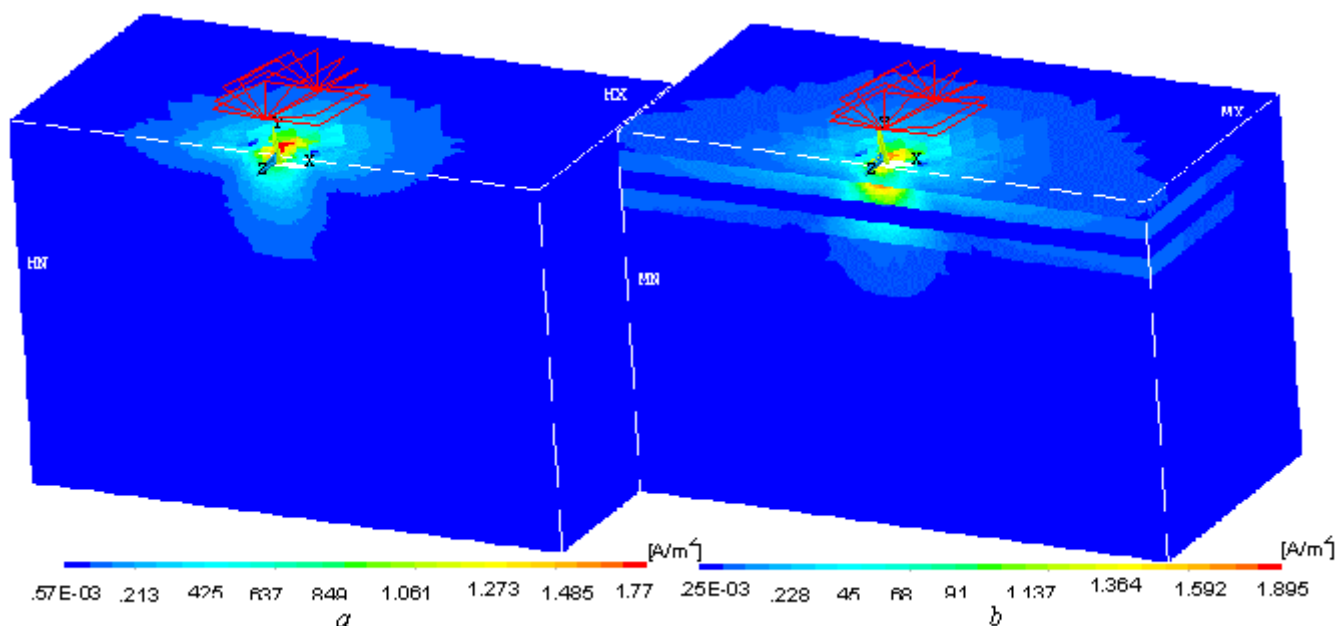

Figure 10 Current density vectors distribution, excited by rectangular coils in a fan-like assembly in the homogeneous (a) and non-homogeneous (b) domains. Section and viewing angle as in Figs. 4,5,6,7.

ysis. However, in the case of weakly conductive media, the iteration just stops at the first cycle.

The different field structures in homogeneous and non-homogeneous media are evident, as well as the relative difference in the current density amplitude values. The latter reach about 15% for horizontal and vertical contours. However, the difference is much more pronounced in some non-homogeneous regions (Figs. 6 and 7). It can be seen that the non-homogeneous structure has an essential influence on the induced currents distribution and on the differences in the current density vector.

An interesting event can be observed in relation to the distribution of the current density. The current lines follow low resistivity paths and in addition to crossing from layer to layer, flowing in opposition to the excitation current, they also rotate inside the low resistivity layer. In order to better illustrate this specific distribution, an example with vertical layers is shown in Fig. 8. Current lines forming loops in the vertical layers can be observed.

Analysis of the results shows, that the method and procedure adopted, introducing boundary conditions in the non-homogeneous domain, is workable. This method could also be applied for other coil shapes and domain structures, without any essential difficulties. Two examples with slinky coils (Fig. 9 and 10) demonstrate the versatility of this method.

The fields resulting from the external coils and the fields created by the induced currents differ by many orders of magnitude (six in our examples), due to the relatively low conductivities of the medium and to the moderately high frequencies. Therefore, ignoring the feedback effects with respect to the introduced boundary condition in solving the internal Dirichlet problem, is justified.

The boundary conditions, related to the components A_x, A_y, A_z of the magnetic vector-potential, can be considered invariant with respect to the co-ordinates.

Another point of interest is that a concentration of induced current densities can be observed at the interface (boundary) between structures of differing conductivities. Hence, a kind of concentration or selective stimulation (focusing) could be predicted or looked for, in structures with relatively well-defined layers of different resistivity (Figs. 6b, 7b and 10b). The concentration in question can be explained by the appearance of surface charges on these boundaries.

It should be reminded here, that the results were obtained for sinusoidal excitation currents. The application of the method for other types of time-varying currents could be addressed by adequate modeling software. The same was valid for studying field distributions in weakly conducting non-linear media.

Conclusion

The results obtained in this work do not provide data that would change the theory or practice of magnetic stimulation. However, our findings can be used to enhance concepts related to electromagnetic field distribution in non-homogeneous structures.

For magnetic stimulation of biological targets embedded in electrically non-homogeneous media, it is helpful to decide upon external system geometry and parameters by considering an accurately obtained distribution of the induced current fields.

The complex interaction between external magnetic field and physiological processes should not deter the search for improved methods for more accurate assessment of the induced currents.

Authors' contributions

SP was responsible for the theoretical basis of the investigation. VK solved the problems of adequate FEM modeling and carried-out the generation and presentation of various field and current distributions. ID was responsible for setting and formulation of the problem and for the biomedical engineering aspect of the study. All authors read and approved the final manuscript.

Acknowledgements

The authors thank the Technical University of Sofia for granting use of the FEM software.

References

1. Stuchly MA: **Applications of time-varying magnetic fields in medicine.** *Crit Rev Biomed Eng* 1990, **18**:89-124
2. Cohen D, Cuffin BN: **Developing a more focal magnetic stimulator. Part I: Some basic principles.** *J Clin Neurophysiol* 1991, **8**:102-111
3. Nakayama H, Kiyoshi T, Wada H, Yunokuchi K, Tamari Y: **3-D analysis of magnetic stimulation to human cranium.** *12th Internat Conf on Biomagnetism, Aug. 13-17, Espoo, Finland, paper 0663 2000* [http://biomag2000.hut.fi/papers/0663]
4. Davey KR, Cheng CH, Epstein CM: **Prediction of magnetically induced electric fields in biological tissue.** *IEEE Trans Biomed Eng* 1991, **38**:418-422
5. Ragan PM, Wang W, Eisenberg SR: **Magnetically induced currents in the canine heart: A finite element study.** *IEEE Trans Biomed Eng* 1995, **42**:1110-1116
6. Al-Mutawaly N, de Bruin H, Findlay RD: **Magnetic nerve stimulation: Field focality and depth of penetration.** *Proc 23rd Ann Conf IEEE/EMBS Istanbul, Turkey, paper No. 1106 Oct 25-28 2001*
7. Maccabee PJ, Amassian VE, Eberle LP, Rudell AP, Cracco RQ, Lai KS, Somasundaram M: **Measurement of the electric field induced into inhomogeneous volume conductors by magnetic coils: application to human spinal neurogeometry.** *Electroencephalogr Clin Neurophysiol* 1991, **81**:224-37
8. Stratton JA: **Electromagnetic theory.** McGraw-Hill Book Co 1941
9. Ulaby FT: **Applied electromagnetics.** Prentice Hall 1999
10. Jorgenson DB, Haynor DR, Bardy GH, Kim Y: **Computational studies of transthoracic and transvenous defibrillation in a detailed 3-D human thorax model.** *IEEE* 1995, **42**:172-183
11. Panescu D, Webster JG, Tompkins WJ, Stratbucker RA: **Optimization of transcutaneous cardiac pacing by three-dimensional finite element modelling of the human thorax.** *Med & Biol Eng & Comp* 1995, **33**:769-775

12. Ren C, Tarjan PP, Popovic DB: **A novel electric design for electromagnetic stimulation – The slinky coil.** *IEEE Trans Biomed Eng* 1995, **42**:918-925
13. Heymann F: **Ueber die Anwendung der Iterationsmethode zur angenaherten Berechnung des Wirbelstroeme und des Wirkwiderstandes.** 1995, **28**:329-336

Publish with **BioMed Central** and every scientist can read your work free of charge

"BioMedcentral will be the most significant development for disseminating the results of biomedical research in our lifetime."

Paul Nurse, Director-General, Imperial Cancer Research Fund

Publish with **BMC** and your research papers will be:

- available free of charge to the entire biomedical community
- peer reviewed and published immediately upon acceptance
- cited in PubMed and archived on PubMed Central
- yours - you keep the copyright



Submit your manuscript here:

<http://www.biomedcentral.com/manuscript/>

editorial@biomedcentral.com