

# Molecular alterations associated with prostate cancer

Herney Andres Garcia Perdomo<sup>1</sup>, James A. Zapata-Copete<sup>2</sup>, Adalberto Sanchez<sup>3</sup>

<sup>1</sup>School of Medicine at Universidad del Valle, Department of Surgery, Cali, Colombia

<sup>2</sup>UROGIV Research Group at Universidad del Valle, Cali, Colombia

<sup>3</sup>School of Basic Sciences, Department of Physiological Sciences at Universidad del Valle, Cali, Colombia

**Citation:** Garcia Perdomo HA, Zapata-Copete JA, Sanchez A. Molecular alterations associated with prostate cancer. Cent European J Urol. 2018; 71: 168-176.

## Article history

Submitted: Oct. 18, 2017

Accepted: March 16, 2018

Published online: March 16, 2018

## Corresponding author

Herney Andres Garcia Perdomo  
School of Medicine at Universidad del Valle  
Department of Surgery  
76001Cali, Colombia  
Calle 4B No. 36-00  
phone: +57 321 2195102  
herney.garcia@correounivalle.edu.co

**Introduction** The amount of information and knowledge about pathways and genetic alterations regarding prostate cancer, including the tools available for its study has been recently increasing. Additionally, a variety of molecular signaling pathways control cell proliferation, however, this incompletely understood process is disturbed in cancer cells.

**Materials and methods** A literature review was made using the MEDLINE, Embase and LILACS databases searching for the following keywords: prostate neoplasms, prostate cancer, molecular medicine, genomics, pathways, and cell cycle.

**Results** Different biological mechanisms have been associated with the development of prostate cancer, such as alterations in tumor suppressor genes, oncogenes (TP53, RB1, among others) and CDKIs; DNA methylation; chromosomal alterations and rearrangements; changes in PTEN and PI3K / mTOR; global defects in apoptosis; alterations in the androgen receptor (AR); and epigenetic mechanisms.

**Conclusions** Good clinical practice and a practical approach have to be based on basic knowledge, thus, in this article, the main genetic alterations, mutations and pathways involved in prostate cancer development were reviewed.

**Key Words:** prostatic neoplasms ◊ molecular medicine ◊ genetics ◊ review

## INTRODUCTION

Recently, the quantity and quality of tools available for the genetic study of cancer and the whole genome have increased, with even greater detail available for the exome alone. Many molecular signaling pathways provide negative or positive regulatory signals that control cell proliferation in a way that attempts to preserve cell number and homeostasis, but this process is completely altered in cancer cells [1, 2].

Normal cells must acquire at least eight attributes to transition from a normal cell to a cancer cell. These attributes include the following: 1) genetic instability and mutation; 2) autonomous growth; 3) insensitivity to internal and external anti-proliferative signals; 4) resistance to apoptosis and other

forms of induced cell death; 5) unlimited cell division potential; 6) ability to form new blood vessels (angiogenesis); 7) local invasive behavior that enables the distinction of benign and malignant neoplasms; 8) evasion of the immune system.

Additionally, cancer cells require energy for autonomous growth and unlimited replication. Tumor-associated inflammatory mediators also cause pre-neoplastic cells to progress to invasive cancer cells; finally, cancer cells gain the ability to metastasize, that is, to migrate and colonize organs or tissues [1, 3, 4]. The purpose of this article was to review and describe the main biomolecular mechanisms associated with prostate cancer. Therefore, the somatic genetic alterations that are involved in the pathogenesis of prostate carcinoma progression are shown in Figure 1 [5, 6].

## MATERIAL AND METHODS

We performed a systematic literature search in Medline via Ovid, Scopus (including Embase) and LILACS from their inception to nowadays with the following keywords: prostate neoplasms, prostate cancer, molecular medicine, genomics, pathways, and cell cycle. We included reviews, systematic reviews, basic science studies and analytical studies, which tried to explain the molecular disturbances associated with prostate cancer. According to the heterogeneity expected, we synthesized information based on the molecular mechanism. Information about the most promising biomarkers associated with prostate cancer can be found elsewhere [7].

### Tumor suppressor genes and oncogenes

Suppressor genes negatively regulate cell growth, and therefore, play an important role in the normal cell cycle, DNA repair and cell signaling. The loss of the function of both alleles of a suppressor gene leads to carcinogenesis; thus, different pathways can result in cancer, such as 1. Homozygous gene deletion, 2. Loss of one allele and mutational inactivation of the second, 3. Mutations in both alleles, or 4. Loss of one allele and epigenetic inactivation of the second allele (e.g., DNA methylation) [1]. The two best characterized suppressor genes thus far are the retinoblastoma gene (RB1) and the TP53 gene, which are described later.

Oncogenes are positively associated with cell proliferation and are the mutated form of normal genes (proto-oncogenes). Two such oncogenes are MYC and MET. MYC is responsible for the regulation of cell proliferation. This amplified gene is frequently present in prostate cancer (PCa), and its expression in prostatic cells has been associated with immortalization [8]. In contrast, MET has been reported in renal cell carcinoma (RCC), primarily in the hereditary type [9]. The mechanisms by which a proto-oncogene can become an activated oncogene are as follows: 1) proto-oncogene mutation, 2) gene amplification and 3) chromosomal rearrangement. An example of the third mechanism is the translocation that leads to the fusion of the TMPRSS2 gene with the ERG oncogene in a large proportion of PCa cases [10]. Figure 2 schematically represents the cell cycle and describes how a cell in G<sub>0</sub> is allowed to proliferate based on a signal, is duplicated in S phase, the phase in which DNA is synthesized, and subsequently segregates its genomic complement, which results in two daughter cells in a process called M phase (mitosis). These two processes are separated by two critical gaps termed Gap 1 and Gap 2. The entire cy-

cle lasts approximately 24 hours, and each phase depends on the previous one. In addition, some mechanisms function to verify the integrity of the DNA. If any alterations are found, the cell attempts to repair the damage, but if repair is not possible, the cell enters an active process termed apoptosis, which will be described later. The loss of the ability to respond to DNA damage leads to genetic instability, increases the mutation rate and mutates genes associated with cancer, thereby contributing to carcinogenesis and progression of the disease [11, 12].

### Retinoblastoma protein (RB1)

RB1 is important for controlling the R-point, which is a decisive point in late G<sub>1</sub> phase during which the cell is committed to undergo division. Thus, if this

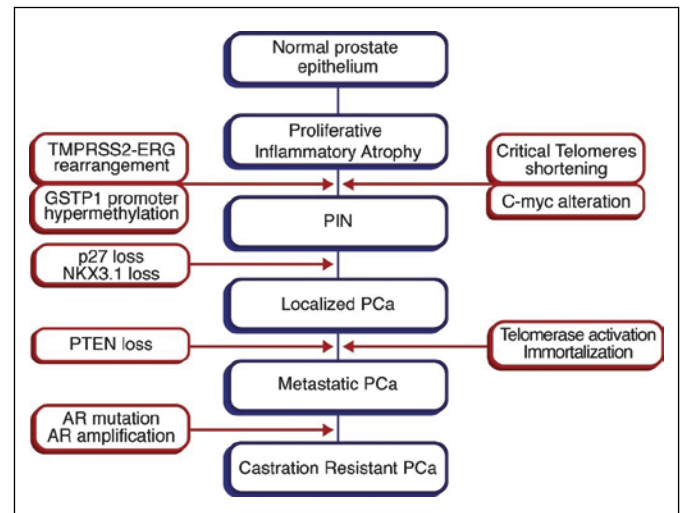

Figure 1. Natural history of prostate cancer and the molecular alterations involved.

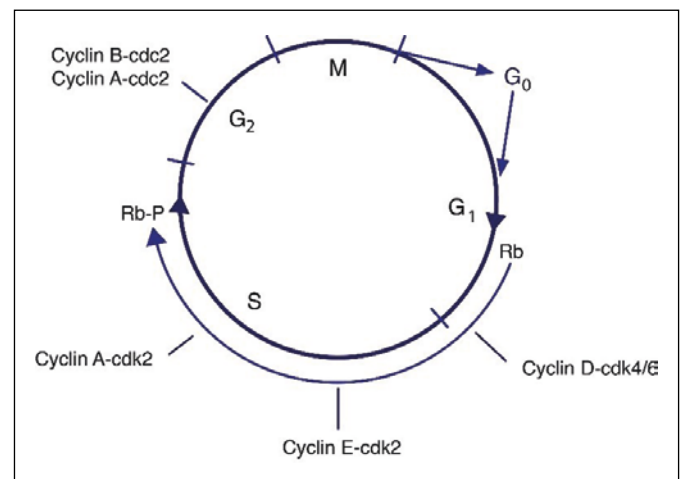

Figure 2. Cell cycle scheme.

control is lost, the cell continues to proliferate. All of the above events are due to inactivation of the RB1 pathway, which is mutated in at least 30% of bladder and prostate tumors, although RB1 mutations have not been strongly associated with these cancer types. It has also rarely been associated with renal carcinoma [13, 14].

### Cyclin-dependent kinase inhibitors

The temporal sequence of events during the cell cycle is dependent on cyclins and cyclin-dependent kinases (CDKs). CDKs phosphorylate protein substrates that are involved in the execution of specific activities in each phase. In contrast, cyclin-dependent kinase inhibitors (CDKIs) bind directly to CDKs and suspend their activity and their ability to phosphorylate other proteins [15]. CDKIs belong to one of two classes: the Cip / Kip Family, which includes the CDKN1A (p21), CDKN1B (p27) and CDKN1C (p57) proteins, and the INK4 (inhibits CDK4) family, which includes the INK4B (p15), INK4A (p16), INK4C (p18) and INK4D (p19) proteins. The p16 protein binds to CDKs 4 and 6 and inhibits their interaction with cyclin D1; normally, active CDK4 and 6 mediate the passage of the cell through G1 phase via the phosphorylation of RB1 [1, 16]. The latter has also been associated with bladder cancer (by deletion of INK4A) and with renal cancer, and p16 inactivation has been shown to occur by hypermethylation of the DNA (epigenetic mechanism) [17]. In prostate cancer, hypermethylation of INK4A is typically seen in 60% of cases, although INK4B is rarely inactivated [18].

Decreased CDKN1B has been correlated with decreased overall survival and disease-free survival after radical prostatectomy. In addition to positive CDKN1B in prostate biopsies, it has been associated with increased biochemical recurrence, and in mice, absence is associated with prostatic hyperplasia [19, 20].

### Tumor suppressor TP53

TP53 is a suppressor gene that plays an important role in response to cellular damage. It signals a halt to the cycle or leads to damage repair pathways (Figure 3), but if repair is not possible, the cell will undergo apoptosis. This suppressor is often mutated in genitourinary cancers. Additionally, Figure 4 shows the possible causes of alterations in TP53 and its responses in the cell cycle.

TP53-induced apoptosis is mediated by Bcl-2 through an intrinsic pathway, and alterations in the regulation of this pathway have direct relevance

in the etiology of cancer. This pathway is associated with the activation of transcriptional genes and the inhibition of other genes that block the cascade. On the one hand, TP-53 is dependent on the activation of the Apaf-1/caspase-9 pathway, but on the other hand, Bax (Bcl-2 family) is not essential for TP53-dependent apoptosis.

In addition, different tumor suppressive pathways are associated with TP53, and some examples are the response to DNA damage, cell senescence and apoptosis, and thus, it is logical to consider that TP53 is frequently mutated in cancer [1, 21].

### Methylation of DNA

The covalent modification of the C5 position of the cytosine by a methyl group is mediated by DNA methyltransferase and results in the for-

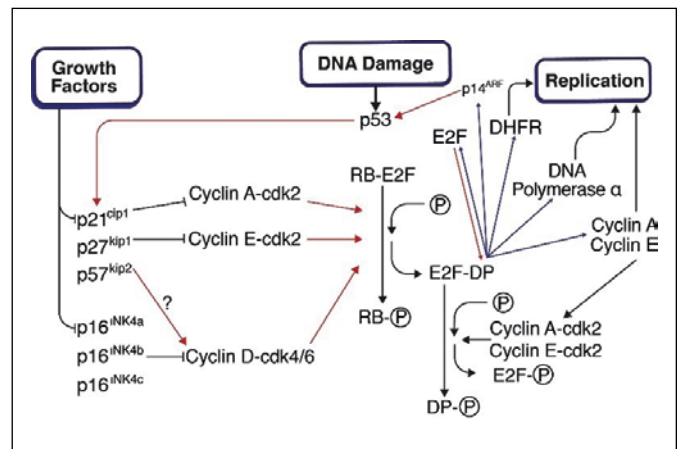

Figure 3. TP53-dependent repair mechanisms.

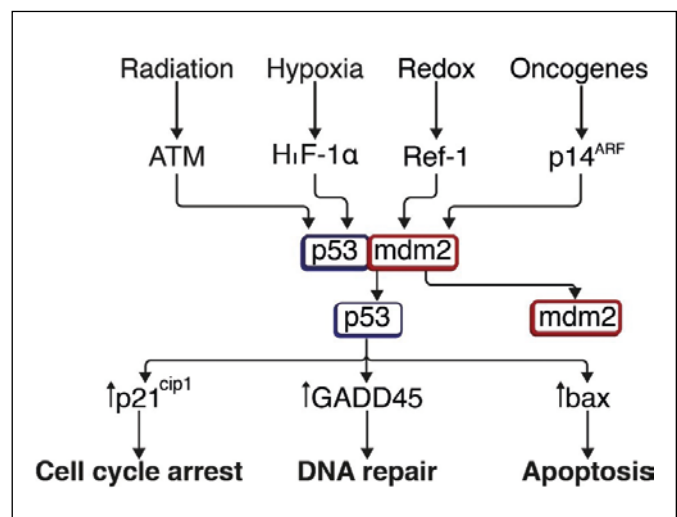

Figure 4. Causes of alterations in TP53 and its response in the cell cycle.

mation of 5-methylcytosine, which is an epigenetic modification that occurs in vertebrates and is part of normal and essential embryological development. As vertebrates have evolved, CpG dinucleotides have become depleted within the genome, but in some areas, this depletion is not seen; these areas are termed CpG islands and represent approximately 1% of the genome. The epigenetic properties of methylation can affect the genetic activity without alterations in the DNA sequence and represent an alternative means to inactivate the gene apart from a mutation or deletion. The three major pathways that DNA methylation uses to result in genetic alterations include the following: 1) inherent mutational effects of 5-methylcytosine, 2) epigenetic effects of the promoter on transcription and 3) activation and potential induction of a gene due to instability of the chromosome by DNA hypomethylation [1].

### DNA methylation and prostate cancer

Glutathione S transferases are a family of enzymes that are responsible for the detoxification of a large group of xenobiotics that catalyze the nucleophilic attack of reduced glutathione in potentially harmful electrophilic compounds. The aberrant methylation of the CpG island at the glutathione S transferase pi (GSTP1) locus is the most frequent somatic alteration reported in PCa [22]. This methylation has been detected in up to 90% of PCa and in 70% of prostatic intraepithelial neoplasia (PIN), however it might be present in normal or hyperplastic tissue [22]. Due to oxidative stress, this aberrant methylation leads to the overexpression of GSTP1 in prostatic epithelial columnar cells. These findings are also associated with worse clinical outcomes [23].

The gene for the ras association domain of the familial protein 1 isoform A (RASSF1A) is located on chromosome 3p21. This is a suppressor gene that is methylated in 60–70% of prostate carcinomas, and it has been observed that this alteration is more frequent in high-grade tumors than in less aggressive tumors [24, 25]. The methylation patterns are not consistent since they can consist of either hypo- or hypermethylation, and in addition, the methylation is conserved in all metastases, suggesting an alteration that follows clonal selection [26, 27].

### DNA damage and repair

Cancer is fundamentally a genetic disease. Alterations in different genes will lead to the activation of differ-

ent pathways associated with cancer, leading to changes in tumor suppressor genes and oncogenes through epigenetic, mutational and copy number distortions. To counteract these elements, the cell employs different defense mechanisms including the use of free radicals such as alpha tocopherol, vitamin C, carotenoids, bilirubin and urate and protective enzymes such as superoxide dismutase, glutathione peroxidase and glutathione transferase. In addition to the previously described methylation of GSTP1, associations have been found between the polymorphisms of this gene and the risk of biochemical recurrence in patients with PCa [28].

The cell additionally employs a series of mechanisms termed the DNA damage response (DDR), which involves a number of genes. DDR relies on the replication machinery, as well as on specific mechanisms such as repairs of base cleavage, nucleotide cleavage, double helix rupture and imbalance [1].

### Chromosomal abnormalities

Deletions of chromosomal segments are frequently found, although gains and amplifications are seen more frequently in cases of advanced disease [12]. These changes have been demonstrated through cytogenetic techniques such as genomic hybridization, fluorescence in situ hybridization or detection of microsatellites. Cytogenetic methods detect numerical changes, while molecular analytic methods identify recombinations that do not lead to changes in copy number [12].

The most frequently altered autosomes are 8, 13, 7, 10, 16, 6 and 17, likely in this order. In addition, gains or amplification of parts of the X chromosome and losses of the Y are also observed. A decreased copy number and loss of heterozygosity of chromosome 8p are also consistent in previous studies (observed in approximately 50% of cases). Specific alterations are observed in each of the chromosomes, but special attention must be paid to the functional impact each alteration may have on the tumor phenotype and the indication or expression of the tumor suppressor genes or oncogenes in the affected regions [12].

### Recurrent genetic rearrangements in PCa

Recurrent gene fusions have been identified, primarily between the androgen-regulated gene TMPRSS2 and ERG, which is a member of the ETS (E26 transforming sequence) family. This fusion occurs in 90% of all fusions that involve ETS genes in prostate cancer [29]. The other fusions occur as a result of more complex types of translocations [10, 30]. In 60% of cases, the fusion occurs due to a deletion of the

sequence that separates the two genes (3 Mb). These rearrangements can be readily identified through reverse transcription polymerase chain reaction (RT-PCR) or by multicolor fluorescence in situ hybridization (FISH).

At present, several clinical studies have evaluated these markers in urine and blood, while other studies have evaluated the expression of the ERG protein using a simpler method (immunostaining) [31, 32, 33]. The TMPRSS2-ERG fusion status is considered a possible diagnostic marker, although its prognostic significance is still unclear, which is a fundamental part of patient follow-up [34, 35].

The TMPRSS2 gene can be merged with other members of the ETS family including ETV1, ETV4 and ETV5 [36, 37].

Studies have been performed with different technologies including next generation RNA sequencing; in these studies, it was found that some fusions are single events or events that occur in only one patient, which might imply that we actually know very little about PCa [38].

### PTEN and PI3K/mTOR

The PI3K/mTOR (mammalian target of rapamycin) pathway plays an important role in cell growth, proliferation and oncogenesis in PCa [39, 40, 41]. PTEN is a negative regulator of this pathway. In retrospective studies, it has been shown how the loss of PTEN and consequently, the activation of the mTOR pathway lead to a poor prognosis in PCa [5]. PTEN deletions have been found in up to 20% of patients with PCa and have been associated with earlier biochemical relapse, metastasis, resistance to castration, presence of ERG gene fusions and the accumulation of nuclear TP53 [5].

### Association with telomeres

A potential association between telomere length and prostate cancer has been found. Initially, this association was found only in studies with small sample sizes, but subsequently, some studies with larger sample sizes were performed in which associations were observed between a short telomere length and decreased overall survival and increased biochemical recurrence. These findings have been consistent even when adjusted for age, Gleason score and lymph node involvement. It has been proposed that cancer that develops from these areas can lead to greater genotype and phenotype heterogeneity, as well as to an increase in aggressiveness [42]. Some studies have even suggested that the risk of death is increased up to 14 times in patients with

short telomeres compared with patients with long telomeres [43].

### Apoptosis

Apoptosis is an orderly, energy-requiring process in which the cellular content is degraded and condensed into an apoptotic body that is finally digested by neighboring cells or macrophages [44]. The positive or negative signals of the apoptotic process finally converge in a family of proteases termed cysteine proteases with aspartic acid specificity. Caspases total at least 13, and some of them are initiators (caspase – 8, caspase – 9, caspase – 10), whereas others are executioners (caspase – 3, caspase – 6 and caspase – 7). Caspases are derived from procaspases, which are larger inactive forms that require proteolytic cleavage in order to become active. They are frequently activated by other caspases (initiator) to generate an activating cascade of executioner caspases. The latter type attacks different anti-apoptotic intracellular proteins such as Bcl-2 and Bcl-XL. They not only destroy their anti-apoptotic functions but also release carboxyl-terminal fragments to remove the cell [45]. They also degrade DNA repair and replication proteins such as DNA-PKcs and replication factor C, leading to nuclear dysregulation.

Nuclear proteins such as laminin, NuMa and SAF-A are fragmented and undergo nuclear dissolution and nuclear condensation (milestones in the cell that lead to apoptosis). Proteolysis of cytoskeletal proteins such as keratin and actin also occurs, which leads to the destruction of the integrity of the internal structure. A final step is the breakdown of cell-to-cell interaction proteins such as beta-catenin and focal adhesion kinase, which precipitates the phenotypic and irreversible changes associated with apoptosis [45].

### Global defects in apoptosis

In both PCa and PIN, a high level of apoptosis is seen, although compared with other malignancies, PCa has low apoptotic activity along with increased replication. As PCa progresses, it is unclear whether androgen-resistant cells have an increased or decreased apoptosis rate because both have been found in patients with castration-resistant prostate cancer [46]. In contrast, an advanced infiltrative tumor whose DNA is mutated and that is fast-growing may have a high rate of apoptosis despite the protective mechanisms that the cell has acquired.

Apoptosis can be initiated by two pathways: the intrinsic and the extrinsic pathways (Figure 5). The intrinsic pathway monitors conditions within

the cell and responds to various forms of stress. Pro-apoptotic signals can originate from damaged and unrepaired DNA or from the lack of signals from the cell surface (cell-cell or cell-matrix contacts, including hormones or diminished growth factors).

Mitochondria and the Bcl-2 family are major components of the intrinsic pathway. The Bcl-2 family contains 12 pro-apoptotic proteins including Bax, Bak, Bok, Bik, Bas, Bid and Bim. It also contains six pro-survival proteins including Bcl-2, Bcl-XL, Bcl-W and Mcl1 [47].

Each protein in the family responds to different stimuli; however, their primary function is to increase the permeability of the mitochondrial membrane [48]. Subsequently, cytochrome c is released from the intermembrane space into the cytoplasm, where it binds to Apaf-1 proteins and forms the apoptosome complex. Caspase-9 is activated, which then activates the entire cascade described above.

In addition, other activations occur such as ones that involve Bid, which is regulated by initiating caspases in the cytosol. Caspase-8 allows the dimerization of Bid with Bax or Bcl-2. This active form of Bax inhibits Bcl-2, which leads to apoptosis. This process can be blocked by anti-apoptotic proteins and by the IAP proteins that inhibit specific caspases [1].

The extrinsic pathway mediates apoptosis after receiving external signals from surface receptors called 'death receptors', such as tumor necrosis factor receptor 1 (TNFR1) and Fas receptor. The death receptor domain is located in its intracellular region and allows binding to adapter proteins that also contain a death domain (RIP, TRADD, FADD). Additionally, these proteins have an effector domain that binds to the caspase recruitment domain (CARD) of the initiating caspase [49]. Subsequently, the initiator caspase is cleaved and is able to activate the cascade. The most well-known death receptor is CD95 or Fas, but this receptor does not appear to have a direct effect on the etiology of cancer. In contrast, IGF-1 can activate the PI3K / AKT anti-apoptotic pathway and stimulate the expression of Bcl-like proteins along with Bax suppression. In addition, the expression of IGF binding proteins may also be altered in PCa [12, 50, 51].

### Androgens and prostate cancer

Most treatments for PCa are based on androgenic suppression, but they are rarely curative. To cure the disease, different mechanisms should be considered and are described as follows (Figure 6): 1) some carcinomas do not express androgen receptor (AR) in some cases because the gene is silenced by a hypermethylated promoter; 2) several peptide growth

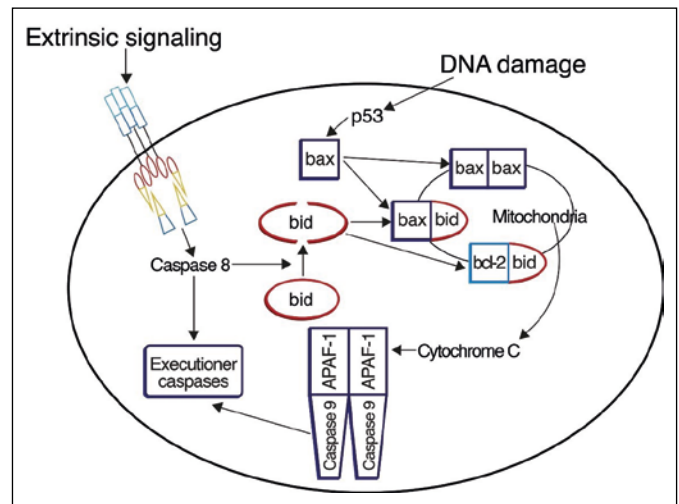

Figure 5. Intrinsic and extrinsic pathways of apoptosis.

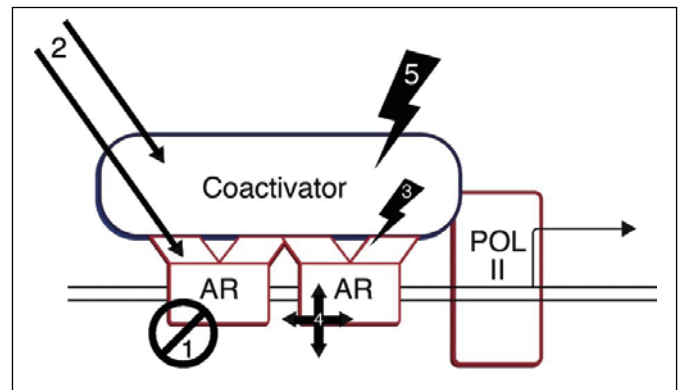

Figure 6. Mechanisms of altered androgen signaling in prostate carcinoma: 1. The androgen receptor (AR) is absent in some carcinomas. 2. Growth factors activate the AR or a coactivator in a ligand-independent fashion. 3. AR mutations alter ligand specificity and affinity. 4. AR expression is increased by gene amplification. 5. Coactivators are differentially expressed or mutated.

factors and cytokines such as fibroblast growth factor 7 (FGF7), epidermal growth factor (EGF) and interleukin-6 (IL-6) can activate the AR synergistically with or independently of a steroid ligand; 3) in some carcinomas, somatic mutations in the AR alter its receptor specificity and cause it to respond to estrogen, progesterone, dehydroepiandrosterone or synthetic anti-androgens; 4) amplification of the AR gene can occur in up to 30% of cases, even in the presence of depletion, which leads to increased sensitivity to a minimal androgen level; 5) different coactivating proteins have been identified as mediators of the effects of AR on chromatin structure, as well as transcriptional initiators and their interactions with other signaling pathways. All of the circumstances

described above could lead to androgen-independent tumor growth [12].

### Expression profiles

With the advent of the analysis of gene expression patterns by cDNA or oligonucleotide microarrays, research related to the diagnosis, prognosis and new therapeutic markers has become increasingly important. For example, it has been found that hepsin is not a good marker since its down-regulation increases tumor heterogeneity in prostate carcinomas [52]. Another marker is the P504S protein, which is identical to Alpha-Methyl-Acyl-CoA Racemase (AMACR); the latter is a peroxisomal enzyme that is involved in the metabolism of branched-chain amino acids, which might be useful for the differentiation of hyperplasia and atrophy from cancer [53, 54].

### Epigenetics / Environmental factors

Lifestyle and dietary habits have been found to be triggers of the oncogenic cascade in PCa. For example, dietary carcinogens, estrogens and oxidants act as a trigger for chronic inflammatory changes within the prostatic tissue and thus act as a promoter of PCa [5, 55, 56]. It has been suggested that the intake of red meat (formation of heterocyclic aromatic amines and polycyclic aromatic hydrocarbon, which have carcinogenic properties) or animal fat is a risk factor for PCa. However, when prevention studies on both of these micronutrients and other elements of the diet were performed, the suppression of those elements was not found to prevent prostate cancer [57]. Additionally, sexually transmitted diseases as part of a system that triggers chronic inflammation in epithelial cells have been associated with the development of PCa (Figure 7) [58, 59, 60].

Given the change from persistent oxidative stress, a survival response is generated by glutathione S transferase, cyclooxygenase-2 and other mediators. In general, the epigenetic silencing of multiple genes occurs, including the silencing of a fundamental

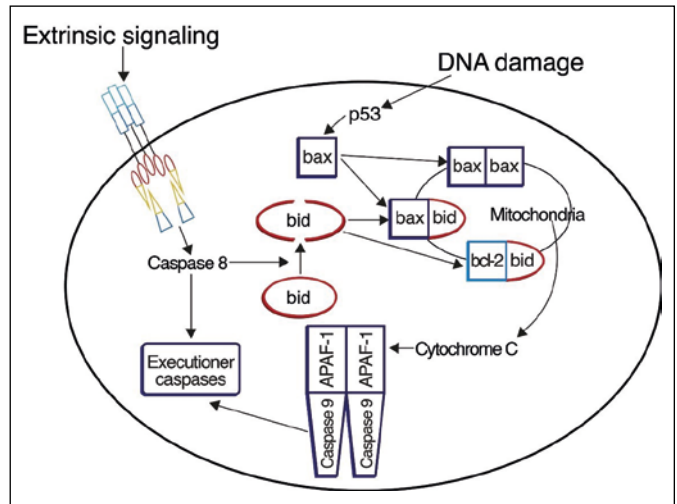

Figure 7. Epigenetic factors associated with prostate cancer.

gene, GSTP1, which is found throughout all stages of prostate cancer progression [5].

### CONCLUSIONS

The natural history of prostate cancer involves numerous genetic and molecular alterations that cause the normal prostatic epithelial cell to become cancerous and resistant to castration. Different biological mechanisms have been associated with the development of prostate cancer, such as alterations in tumor suppressor genes, oncogenes (TP53, RB1, among others) and CDKIs; DNA methylation; chromosomal alterations and rearrangements; changes in PTEN and PI3K / mTOR; global defects in apoptosis; alterations in the AR; and epigenetic mechanisms. These are not the only mechanisms, but they have been found to be associated with prostate cancer at a higher frequency than others. Similarly, the development of prostate cancer does not have a unique etiology, but rather, it is predominantly multifactorial and can be explained by the different mechanisms described here.

### CONFLICTS OF INTEREST

The authors declare no conflicts of interest.

### References

- Gonzalzo M, Stefanos K, Meeker A. Part IV. Molecular and cellular biology. In: Wein A, Kavoussi L, Partin A, Peters C, eds. Campbell Walsh Urology. Eleventh. Philadelphia: Elsevier Inc. 2016; p. 459.
- Feitelson MA, Arzumanyan A, Kulathinal RJ, et al. Sustained proliferation in cancer: Mechanisms and novel therapeutic targets. *Semin Cancer Biol.* 2015; 35: S25-54.
- Hanahan D, Weinberg RA. Hallmarks of Cancer: The Next Generation. *Cell.* 2011; 144: 646-674.
- Luo J, Solimini NL, Elledge SJ. Principles of cancer therapy: oncogene and non-oncogene addiction. *Cell.* 2009; 136: 823-837.
- Netto GJ. Molecular Updates in Prostate Cancer. *Surg Pathol Clin.* 2015; 8: 561-580.
- Netto GJ, Cheng L. Emerging critical role of molecular testing in diagnostic

- genitourinary pathology. *Arch Pathol Lab Med.* 2012; 136: 372-390.
7. Esquivel Parra L, Caicedo Bolaños A, Guaitarilla J, García-Perdomo H. Una mirada general a los biomarcadores para la tamización y el diagnóstico temprano del cáncer de Próstata. *Urol Colomb.* 2017; 26: 110-116.
  8. Gil J, Kerai P, Lleonart M, et al. Immortalization of primary human prostate epithelial cells by c-Myc. *Cancer Res.* 2005; 65: 2179-2185.
  9. Schmidt L, Duh FM, Chen F, Kishida T, et al. Germline and somatic mutations in the tyrosine kinase domain of the MET proto-oncogene in papillary renal carcinomas. *Nat Genet.* 1997; 16: 68-73.
  10. Tomlins SA, Rhodes DR, Perner S, et al. Recurrent Fusion of TMPRSS2 and ETS Transcription Factor Genes in Prostate Cancer. *Science.* 2005; 310: 644-648.
  11. Bartek J, Lukas J, Bartkova J. Perspective: defects in cell cycle control and cancer. *J Pathol.* 1999; 187: 95-99.
  12. Schulz W, Burchardt M, Cronauer M. Molecular biology of prostate cancer. *Mol Hum Reprod.* 2003; 9: 437-448.
  13. Kubota Y, Fujinami K, Uemura H, et al. Retinoblastoma gene mutations in primary human prostate cancer. *Prostate.* 1995; 27: 314-320.
  14. Logothetis CJ, Xu HJ, Ro JY, et al. Altered expression of retinoblastoma protein and known prognostic variables in locally advanced bladder cancer. *J Natl Cancer Inst.* 1992; 84: 1256-1261.
  15. Sherr CJ, Roberts JM. Inhibitors of mammalian G1 cyclin-dependent kinases. *Genes Dev.* 1995; 9: 1149-1163.
  16. Serrano M, Hannon GJ, Beach D. A new regulatory motif in cell-cycle control causing specific inhibition of cyclin D/CDK4. *Nature.* 1993; 366: 704-707.
  17. Merlo A, Herman J, Mao L, et al. 5' CpG island methylation is associated with transcriptional silencing of the tumour suppressor p16/CDKN2/MTS1 in human cancers. *Nat Med.* 1995; 1: 686-692.
  18. Herman JG, Merlo A, Mao L, et al. Inactivation of the CDKN2 / p16 / MTS1 Gene Is Frequently Associated with Aberrant DNA Methylation in All Common Human Cancers DNA Methylation in All Common Human Cancers. *Cancer Res.* 1995; 55: 4525-4530.
  19. Freedland SJ, DeGregorio F, Sacoolidge JC, et al. Preoperative p27 status is an independent predictor of prostate specific antigen failure following radical prostatectomy. *J Urol.* 2003; 169: 1325-1330.
  20. Cordon-Cardo C, Koff A, Drobnjak M, et al. Distinct altered patterns of p27KIP1 gene expression in benign prostatic hyperplasia and prostatic carcinoma. *J Natl Cancer Inst.* 1998; 90: 1284-1291.
  21. Oda E, Ohki R, Murasawa H, et al. Noxa, a BH3-only member of the Bcl-2 family and candidate mediator of p53-induced apoptosis. *Science.* 2000; 288: 1053-1058.
  22. Jerónimo C, Usadel H, Henrique R, et al. Quantitation of GSTP1 methylation in non-neoplastic prostatic tissue and organ-confined prostate adenocarcinoma. *J Natl Cancer Inst.* 2001; 93: 1747-1752.
  23. Maruyama R, Toyooka S, Toyooka KO, et al. Aberrant promoter methylation profile of prostate cancers and its relationship to clinicopathological features. *Clin Cancer Res.* 2002; 8: 514-519.
  24. Liu L, Yoon J-H, Dammann R, Pfeifer GP. Frequent hypermethylation of the RASSF1A gene in prostate cancer. *Oncogene.* 2002; 21: 6835-6840.
  25. Kuzmin I, Gillespie JW, Protopopov A, et al. The RASSF1A tumor suppressor gene is inactivated in prostate tumors and suppresses growth of prostate carcinoma cells. *Cancer Res.* 2002; 62: 3498-3502.
  26. Yegnasubramanian S, Wu Z, Haffner MC, et al. Chromosome-wide mapping of DNA methylation patterns in normal and malignant prostate cells reveals pervasive methylation of gene-associated and conserved intergenic sequences. *BMC Genomics.* 2011; 12: 313.
  27. Aryee MJ, Liu W, Engelmann JC, et al. DNA methylation alterations exhibit intraindividual stability and interindividual heterogeneity in prostate cancer metastases. *Sci Transl Med.* 2013; 5: 169.
  28. Nock NL, Bock C, Neslund-Dudas C, et al. Polymorphisms in glutathione S-transferase genes increase risk of prostate cancer biochemical recurrence differentially by ethnicity and disease severity. *Cancer Causes Control.* 2009; 20: 1915-1926.
  29. Kumar-Sinha C, Tomlins SA, Chinnaiyan AM. Recurrent gene fusions in prostate cancer. *Nat Rev Cancer.* 2008; 8: 497-511.
  30. Perner S, Mosquera J-M, Demichelis F, et al. TMPRSS2-ERG fusion prostate cancer: an early molecular event associated with invasion. *Am J Surg Pathol.* 2007; 31: 882-888.
  31. Falzarano SM, Zhou M, Carver P, et al. ERG gene rearrangement status in prostate cancer detected by immunohistochemistry. *Virchows Arch.* 2011; 459: 441-447.
  32. Park K, Tomlins SA, Mudaliar KM, et al. Antibody-based detection of ERG rearrangement-positive prostate cancer. *Neoplasia.* 2010; 12: 590-598.
  33. Chau A, Albadine R, Toubaji A, et al. Immunohistochemistry for ERG expression as a surrogate for TMPRSS2-ERG fusion detection in prostatic adenocarcinomas. *Am J Surg Pathol.* 2011; 35: 1014-1020.
  34. Fine SW, Gopalan A, Leversha MA, et al. TMPRSS2-ERG gene fusion is associated with low Gleason scores and not with high-grade morphological features. *Mod Pathol.* 2010; 23: 1325-1333.
  35. Leyten GHJM, Hessels D, Jannink SA, et al. Prospective multicentre evaluation of PCA3 and TMPRSS2-ERG gene fusions as diagnostic and prognostic urinary biomarkers for prostate cancer. *Eur Urol.* 2014; 65: 534-542.
  36. Helgeson BE, Tomlins SA, Shah N, et al. Characterization of TMPRSS2:ETV5 and SLC45A3:ETV5 gene fusions in prostate cancer. *Cancer Res.* 2008; 68: 73-80.
  37. Tomlins SA, Mehra R, Rhodes DR, et al. TMPRSS2:ETV4 gene fusions define a third molecular subtype of prostate cancer. *Cancer Res.* 2006; 66: 3396-4000.
  38. Pflueger D, Terry S, Sboner A, et al. Discovery of non-ETS gene fusions in human prostate cancer using next-generation RNA sequencing. *Genome Res.* 2011; 21: 56-67.
  39. Sarker D, Reid AHM, Yap TA, de Bono JS. Targeting the PI3K/AKT pathway for the treatment of prostate cancer. *Clin cancer Res.* 2009; 15: 4799-4805.
  40. Bismar TA, Yoshimoto M, Vollmer RT, Duan Q, Firszt M, Corcos J, et al. PTEN genomic deletion is an early event



- associated with ERG gene rearrangements in prostate cancer. *BJU Int.* 2011; 107: 477-485.
41. Han B, Mehra R, Lonigro RJ, et al. Fluorescence in situ hybridization study shows association of PTEN deletion with ERG rearrangement during prostate cancer progression. *Mod Pathol.* 2009; 22: 1083-1093.
42. Fordyce CA, Heaphy CM, Joste NE, Smith AY, Hunt WC, Griffith JK. Association between cancer-free survival and telomere DNA content in prostate tumors. *J Urol.* 2005; 173: 610-614.
43. Heaphy CM, Yoon GS, Peskoe SB, et al. Prostate cancer cell telomere length variability and stromal cell telomere length as prognostic markers for metastasis and death. *Cancer Discov.* 2013; 3: 1130-1141.
44. Fadok VA, Savill JS, Haslett C, et al. Different populations of macrophages use either the vitronectin receptor or the phosphatidylserine receptor to recognize and remove apoptotic cells. *J Immunol.* 1992; 149: 4029-4035.
45. Wolf BB, Green DR. Suicidal tendencies: apoptotic cell death by caspase family proteinases. *J Biol Chem.* 1999; 274: 20049-20052.
46. Koivisto P, Visakorpi T, Rantala I, Isola J. Increased cell proliferation activity and decreased cell death are associated with the emergence of hormone-refractory recurrent prostate cancer. *J Pathol.* 1997; 183: 51-56.
47. Adams JM, Cory S. The Bcl-2 protein family: arbiters of cell survival. *Science.* 1998; 281: 1322-1326.
48. Kroemer G, Reed JC. Mitochondrial control of cell death. *Nat Med.* 2000; 6: 513-519.
49. Ashkenazi A, Dixit VM. Death receptors: signaling and modulation. *Science.* 1998; 281: 1305-1308.
50. Grimberg A, Cohen P. Role of insulin-like growth factors and their binding proteins in growth control and carcinogenesis. *J Cell Physiol.* 2000; 183: 1-9.
51. Chan JM, Stampfer MJ, Ma J, Gann P, et al. Insulin-like growth factor-I (IGF-I) and IGF binding protein-3 as predictors of advanced-stage prostate cancer. *J Natl Cancer Inst.* 2002; 94: 1099-1106.
52. Srikantan V, Valladares M, Rhim JS, Moul JW, Srivastava S. HEPsin inhibits cell growth/invasion in prostate cancer cells. *Cancer Res.* 2002; 62: 6812-6816.
53. Jiang Z, Woda BA, Rock KL, et al. P504S: a new molecular marker for the detection of prostate carcinoma. *Am J Surg Pathol.* 2001; 25: 1397-1404.
54. Rubin MA, Zhou M, Dhanasekaran SM, et al. Alpha-Methylacyl coenzyme A racemase as a tissue biomarker for prostate cancer. *JAMA.* 2002; 287: 1662-1670.
55. Sfanos KS, Hempel HA, De Marzo AM. The role of inflammation in prostate cancer. *Adv Exp Med Biol.* 2014; 816: 153-181.
56. De Marzo AM, Platz EA, Sutcliffe S, et al. Inflammation in prostate carcinogenesis. *Nat Rev Cancer.* 2007; 7: 256-269.
57. Jurado-Penagos A, García Perdomo HA. Efectividad de los micronutrientes en la prevención del cáncer de próstata. *Rev Fac Med.* 2014; 62: 65-72.
58. Elkahwaji JE. The role of inflammatory mediators in the development of prostatic hyperplasia and prostate cancer. *Res Rep Urol.* 2012; 5: 1-10.
59. Sutcliffe S, Neace C, Magnuson NS, Reeves R, Alderete JF. Trichomonosis, a common curable STI, and prostate carcinogenesis—a proposed molecular mechanism. *PLoS Pathog.* 2012; 8: e1002801.
60. Sutcliffe S, Platz EA. Inflammation and prostate cancer: a focus on infections. *Curr Urol Rep.* 2008; 9: 243-249. ■